

# ***Mini Hi-Fi Component System***

---

qLF · u √

***GameSync***  
**M I X I N G**

**COMPACT**  
**disc**  
**DIGITAL AUDIO**

***MHC-GX45/GX35/GX25  
MHC-RG440S/RG330/RG310/  
RG220***

U~ <^a u U Ø u g ´ dD · ØdC  
fibO b ´ d X u U E · U  
<t U E U · U~ ´ t uN XL <Ø u g ´ dD  
s E ØU lL U E bO U u d~ ´ t dH ´ u U  
fibO b ´ d U~ ´ ØE  
´´ · d `UO · ´´´ ´ d · <^a U Ø u g ´  
fibOM Ø ´´´u U~ ´ ØE ´ bK

U ´U t H p q Ø uB ØU UC  
fibOM Ø ´´´u XMO U

· uB X% U~  
tI CLASS I LASER  
V d s ´ fi´u v  
U~ ´ v U XL  
fi´dO v

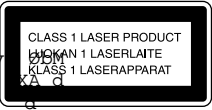

v~ U v uLF ØU t U U~ ´ dt · Ød U  
´UF U{ ´uM t ´ d ´ E´´´ t ´ d E´  
fibOzU/ l ´ vzuU

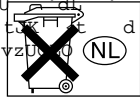

vzU E · ØU b Ø´d e t  
b X X ENERGY STAR®  
p ´uMony X d fiX ´ v U´ d  
t ´ v ENERGY STAR® p d  
ENERGY STAR® ØU ´d · uB s  
fi´ U v ´ E ´ d · Ø d ´ v ´ U Ø´d





b U/ g b 'u v/ r O s ' t v u p ~ ~ s ' . ' ~ UH ' v ~  
UCD-ROM • qLF ' .

d ØU X d ~ t v CD-R/CD-RW t U  
" b u v j { U~ ' : ~ UH ' U ' U ~ dJKL • bL u  
v U ~ dJKL sOL UN M <b U/ v ' dA E  
vIO u p ~ X d > U U sOL Ø' ' t U~ ~ ØE ØU tL ~  
Joliet < † ' d fISO 9660 U MP3 X d > fib u U\$' bM U v t UA ØU  
o DM (Multi Session) Ø' E' bRomeo  
fib dO v ' d ~ UH ' ~ u qLF • u ~ s

'qJ v K <v U U u t α ~ ' b U . d o q J t v J ~ uNH ~ U/  
f i ~ v ~ UH ' v u ØU p ~ U ~ U ~ U ~ d U  
fib U V d U c U ' ØE d t b u v ~ U t v U ~ U  
p U < U uK V ' u < bM ~ u ' d uM t v J ~ MP3

b n d CD-ROM ØE U b Ed E U q U v I D M X d MHC-GX45/GX35/RG440S/RG330/RG310 •  
'vKK\*' sO ~ ' bISO j t R d BM v zU b ' v E E MHC-RG220U b a  
fib u ~ ~ g U/ bM ' u v ' d U t - d . b U fib u v ~ UH ' ' O { u Ø' d  
Multi Session Ø' E' bM  
E ' ~ UH ' U U ' ~ d t U { t X ' v E s g q U ØU p ~

Lead-in U U p ~ d M ~ Eb p' ~ v uLF ØU p  
p fibM v Lead-out tU U ~ Eb p ~ E b U L fibO U/ g r O s ' U ' d ØU  
d t b U v E' bM Ø' ~ t X ' v J ~ Ø' E' bM p ~ fibM O g q U U p  
~ dHM E' pLead-in ~ lead-in ~ XL  
f i ~ u v ~ u

ØE ' ' v u p ~ ' U ' a GD-Extra s ' " g q U ØU p ~ X dN  
v j { E' ~ U a' d ØE ' E' ' U ' U ' E' d  
fib U/  
' u E a' d s O E' ØE ' ' U ' X d s " u k p ~ p ~ X d  
p ØbF ØU a' d E a' d s O E' ØE ' ' v u p ' u ' U ' v u ØU p ~



'u			CD-R/CD-RW 'v u 'U ' a
'u			CD-R/CD-RW *MP3 ØU q U a

EMHC-GX45/GX35/RG440S/RG330/RG310 jI\*  
'v E E v zU E MHC-RG220

' XE U Ø u uMJ Ø' v u ØUNJ **CD-RW** ~~CD-R~~ ØL ØU t u  
 çdA o bMM vUH j u t v U b v b  
 ~dA ØUNJ v U U ØUNJ v g v d g Ut bōsu/ t u UN M fib U/ g X  
 fix b **CDd** v' b U j' d U j { Ø' d b vUH j { tKO E  
 ' XE U Ø u uMJ Ø' v uM v u ØUNJ v <do fib U LbI X' sJ2 p  
 b U v' E bMM j { ØUN d s' **CD-RW** ØA u o v ØL b j { ØU p  
 sJ2 UN v' vCF <UNJ v s' sO v' **CD-RW** ØA u o v ØL b j { ØU p  
 U~ v s' U X' sJ2 E b **CD** U UK U v' b U fib uA g u v  
 fib U g q U ØbM d a bM U **CD-RW** ~~CD-R~~ tØU p v  
 'b U/ v d o p v Ø'U bMM g p  
 ° u t t vJ v g U~M °U UO fib u g bM u v/  
 v u v j { Ø' E v bMM u t **CD-RW** ~~CD-R~~ ØU p v  
 v/ v U O A b' t A~ U9 ç E v 7 ç .  
 p uM t v **CD-DA** E d p U p d . fib u  
 t bO U g E **CD-DA** v u uM p v tMP3 X d U ØU q U g t v U X' s  
 fib U vMPS v' E v p fib U b **MB3** ç b tç  
 p v p uM t MP3u E d p U p d . b u Ø' MP3 dO X d U ØU q U g Ø' d  
 'v u a E v p t bO U g MP3L v d v u t U M X' U v U t d **MP3** sJ2 bM  
 fib U v **CD-DA** fi v d v dJKL  
 U q U v v MP3Up j v up g v E b U U b t E **ISO 9660** dO t v U X d  
 fi v d v sOOF p v d v b bQ u uA v v g U/ v v t X' sJ2  
 p v p uM t uK p v p X d U bO v p E d Ø' d Ød v u U t d  
 fi v d v **CD-DA** v u a fib v

fi v v bO O U U U b j {  
 fi Ø' E v bM u t b j { p  
 v UN p v a v u t U { ' t b u v v U  
 fi' bA

fibO ~ U\$' U~ ~ t oKF ØU rO 5E 1E U{ 'd' < WH'u' W O d'd q E

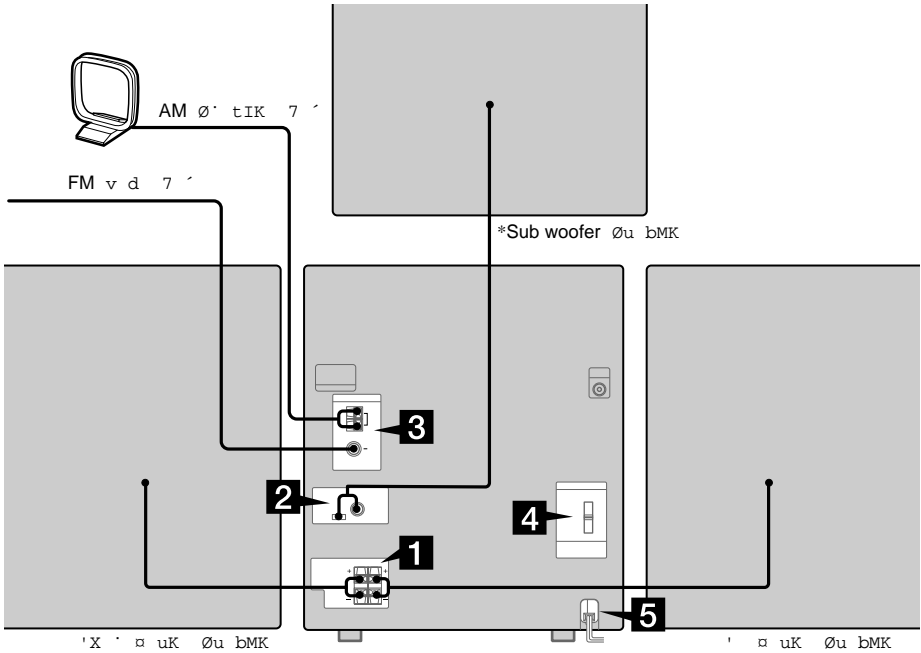

MHC-RG440S MHC-GX45 jI\*

fibOM q **Sub woofer** Øu bMK **2**  
**MHC-RG440S MHC-GX45** jI Ø  
 ~ ~ g U/ d qJ ~ t v u t . quE **SPEAKER** ØØ t U U t X' b ~ ~  
 gO **SUB WOOFER OUT** gO t X' b  
 fibOM **SUB WOOFER CONTROL**

fibOzU/ q E' **1** u bMK  
 qJ ~ t v u t . E X' Øu bMK  
 quE **SPEAKER** ØØ t U U t X' b ~ ~  
 fibOM

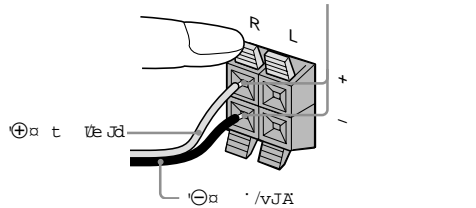
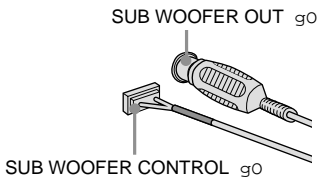

fibOM q E Ø 'u ~ v Ed p 5 · LdO rO fibOM q AM LFM ØU 7 3  
 UL t v U~M fi~u v 'b b d~A U/ t fiHOM ~ ØdE UA ' f AM Øu/ t vE 7 '  
 u t d~UA E b s E L / O < bO ~ UA ·  
 fi~u v lD pO U u ·  
 tLOL{ u ~ ~ < X O V UM Ø 'u ~ e s ~ t ~ E ~  
 u ~ ~ t v U b Ø 'd j I a b O U ~ b · t s ~  
 fi'b ~ ~ tLOL{

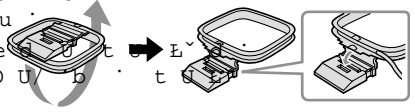

q ~ ~ AA e'UR6 Ød U ~ b E ~  
 bO ~ 'd E ~ · ·

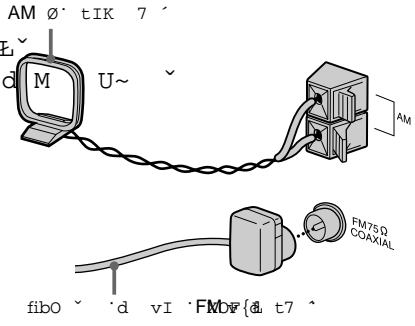
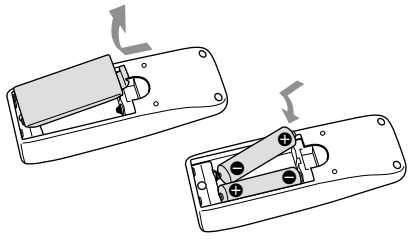

t u fib ~ U~ E~ u bMK ØU rO  
 <bOM v/ ~UH ' v u 'b Ø'd E~ · · d M U~ U~ E~ d U · Ø · 4 ØU b  
 · UN ' <U Ød U XA ' v U v UL · ØU VO ' j ØdO uK XN  
 fibOM U U~ ØEØO j U E  
**VOLTAGE SELECTOR**  
 fibO ~ 'd vK  
 t J fib U ' E UH X sJ2 U E d~ U

bOH dL U g ~Eb U~ · · UH · Ø~U j 'd U Ød U  
 d M XOK U d~ · E~ · · d M U~ t v U ~ M HX ~ BM ~ u  
 fibOM i uF u ØU Ød U U · qLF ØU Ød U < X

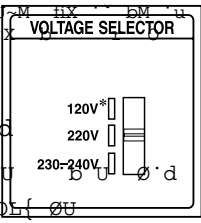

u bMK ØU p A U ~ d q E Ø 'd  
 p A U <UN ' eG · ØdO uK E U u bMK Ø U ·  
 fibOM q E UN ' t · U u bMK tLOL{ ØU

X E-t >-t · " Ø~uF U \* d b

Ø'd · a X · fi' a uK Øu bMK  
 E MHC-GX45/GX25/RG440S/RG310  
 MHC-RG220

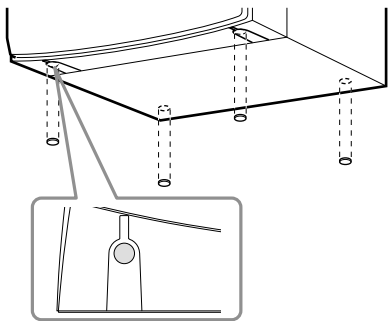

# X U rOEM

Ø'd · X · fb' · uK Øu bMK

MHC-RG330 MHC-GX35

MHC-GX45 Ø' Sub woofer Øu bMK

MHC-RG440S

fibO ~ UA r O b d/Ø 1 ·  
 fibO ~ U**CLOCK/TIMER SET** 2  
 UA "EUM u t X U >>> U <<< 3 ·  
 fibO ~ U**ENTER** 4  
 UA "EUM u t tIO >>> U <<< 5 ·  
 fibO ~ U**ENTER** 6  
 fibM v U t Ed X U r O qL lu ~  
 X U rOEM Ø'd · d qLF · u < v dA p ~ eO UJ  
 fibO ~ U**CLOCK/TIMER SET** 1  
 UA **CLOCK SET** U · Ø >>> U <<< 2  
 fibO ~ U**ENTER** f < · · ·  
 fibO ~ U**ENTER** 6 3 q'd qLF · 3 u

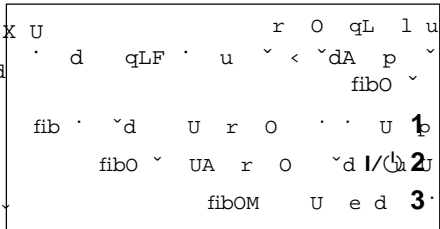
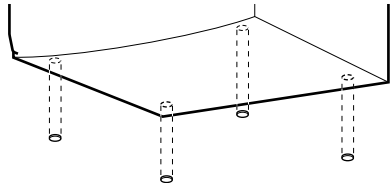

t u  
 d lD U ~u/ lD · EdO rO UB · t v u · X U · U/OEM  
 fib ~d v uG b HO

**MHC-GX45** jI **Sub woofer** v U/U  
**MHC-RG440S** E

Ø'b XOF u E XN hO A t ~U U · u  
 v bO u -U deSub woofer p j u t vO  
 U · ØU Sub woofer bO 'u v UL <b U v/  
 U Ø'd t rOM v tO u U fibO ~ 'd  
 VK n ØE Sub woofer <d N , Ø'b p bO u  
 fibO ~ 'd X · qL U 'b g O

t u  
 bM 'd ' E ~ · · · 'd Ø' Sub woofer t 'uL  
 fib ~ U ~ 'u ~ 'E ~ Ød  
 t b 'u v , Ø'b 'u 'Sub woofer dU · j E ~  
 fib U v U · ØU 'u dO Q XK t s · fib  
 U U U · Sub woofer <'U · UH · Ø' u SOM d  
 UM ~ 'U t H p ~ · · · 'd U · U ·  
 fibO U/ æc d~ · E d t U E



p v g

uK g fløU -g

MP3 CD

MP3 / p v g

p v p ø c øU

MP3 / p v g

p v E v u øU p v U b v UJ · UL t r o s fibo v UA · **1** øL  
 fibo U/ gMP3 v u øU a·d U xøU t · · X Ed t v u **2** · p  
 LMHC-GX25 øLMP3 v u øU a·d fibo v ·d p v vMO øL b U  
 q U 'v E E vzU E · øLMHCgRG22a e t ø  
 fibM U v/ g

fi v u v ø ·c~ U p v p t v U~M "

p v vMO øLd UL



p d~ UA g U

fibo v **CD 1**

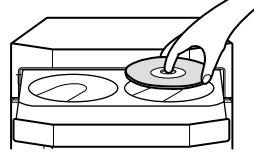

tL v <p v ød AO v ·bF ø ·c~  
 ø·d · b **DISC SKIP/EX-CHANGE**

fibo v UA p v vMO g d

fi u t p v vMO U bo v **3** · b

t u  
 vUH · · v u E · øL d dOL v V d  
 fi u v dJKL v u V u X · sJ2 U s ·  
 ·d bo b UA v t ·b U · v u ·XA~ · p  
 fi u v dJKL v u V u X · sJ2 U

v v t v v

**PLAY MODE 2**

U ^dJKL d U b 'b b U n u UA "EUM u t d~A U/ ^ UL 'u)^ XC

---

bo ^ U\$ . . U s . ' o'd fibO ^ g n u

---

s . ^b ^^^ UA fibo ^ UA u' n u fib ^d v U g X U t tL ^

---

fibO ^ a'd p "U

---

bF "EUM +uALBUM- u ^ p "U fibo ^ 2Uzk d . -\*MP3

---

^^ UA g ^ a'd ØE Ø' tØE ØE u MP3 ŷ u ØU a'd UALBM fibo U/ U 'd ^ 'u)^ tDI ^ fibo U/ ^ bØE d t b . ^d "U ' UØUt gvj^

---

U^\*DISC 1-3 UDISK SKIP ^ p ^ p "U ØE u MP3 dØ p ^ p g U-M DISC SKIP/EX-CHANGE n u XOF{E fi'u v DISC g t u ^

---

fibO ^ UA . 'b 'E ØE ' u t U p ^ U9 ØE ALL DISCS

---

bo ^ UA . DISC ØE . U~ ^ ^dJKL dOOG fi'v UH 'a Eb SHUF

---

fi'l M pØ U u ^ dU U ^ d~ ^ l M p "U ^ UL t vJ ^ ØDISC SHUF

---

'DISC SKIP/EX-CHANGE ^ U p ^ d U i uF fi'v UH 'a Eb ' u t uE 'g'da

---

fibO ^ UA g X U ØE u MP3 ŷ u ØU \*ALBM SHUF

---

fibO ^ UA . ^b 'E ØE ^ p 7 ^d ' u t b . ^d "U ^ UL uK v g Ø

---

fibO U t U BM ØU q U sØ u -\* t g MP3 dØ p ^ p g U-M UA 'O ' u t X 'sJ2 U U q U v d Ø'd SOM L fi'u v q b DISC SHUF U t u ^ uK

---

MP3 v u ØU a'd Ø'd e v t UL t v O d t p ^ ØE ØGM a'd <^u v "ALL DISCS SHUF t v Ø-M ^ U ^ u t U d 7 U Ø bØ U d g ^ fibM U v/ dDISC d-U3 fi'boZU/ tE+t H

MHC-GX45/GX35/RG440S/RG330/ jI \*  
 'v E E vzU E MHC-RG220 RG310

“LUM u t

ø 'dJ g

MP3 CD

MP3 / p , g

p ~ p øE ~dHM a'd p U U  
fibO U/ g  
EMHC-GX25 øEMP3 v u øU a'd øE ø Ed{ do øU u ~ U d~ 'u  
'v E E vzU E ' øU MHCØRG22ø t ø v d bMB3 v u øU a'd øEU t øU u  
fibM U v/ g q U

fibO ~ doOG g ~ ' g XOF{E bo  
qO ' bo O VO d U b j { øU p ~  
fib U UO U ø 'bI t X ' sJ2 ~U  
øE øU q U U9 bMM g <~u v •ø 'c~ U  
MP3do v u øU a'd E U u ' d ' fib 'u  
E g Ed ø'd X ' sJ2 <b U t ' ~u E p  
fi~u Ed ø~U MP3 øbF a'd g Ed U P  
øMP3 bo d~ tV øU øU øU a'd ø Ed{  
v tO u U fibOzULM MP3- bOM vø'd'UH  
fibOzULM dMP3 vXu' øU a'd øEU t vJ  
d bMB3 v u øU a'd øEU t øU u  
fi~u

d~A U/ d M

'TA b Ed- q"U u ~'bF d  
p ~ p øMP3 øU u ' E v u øU a'd ~'b  
~UH fib U f'bb 'u v ~dHM  
fix ' d c UJd' 'bd U g  
g b ' b j { p ~ øMP3 v u øU a'd  
fib ~d v  
j { tD 'E U j { tKøøU<øu'c ee '• d t  
ø'dx 'UøZMP3 v"u a'd p j { U ~'U  
fib ~d t 'u X ' U E 'b LD <g XOK U

'b REP1ø UREPøU bo ~ REPEAT  
fi~u

fi U ZM d 'b ø'd p ~ øREPøU  
fi'a'd p øREP1UNM

ø 'dJ g uG ø'd

t REP1ø EREPø øE~ d b REPEAT  
fibO ~ UA "LUM u

t u

U eL ALL DISCS SHUFøE REPø bo 'u ~/ UL  
fibOM "U

v U U b "U ' a'd REBOJ tv v "U-M ' ' ø  
fi~u v g U U v u t øREP1ø t <bOMJ uG

fibOM øe t U d · ød t U { 6  
 bOM 'dJ ' q 'd s 'øe t U d ø'd  
 5 B U p v d U  
 5 # p v sOL øL U a'd d U  
 5 B U p v d U øL U a'd d U

U ~ u t U d 7 U  
 ø' t U d - g  
**MP3 CD**

fibO v U 7  
 fi~u v Ed ø' t U d g.  
 U ~ dJKL d U  
 bo ~ U\$ . . U s . ø'd  
 U PLAY MODE <n u XOF{L ø' t U d g  
 UA "EUM çPGMçt b u  
 fibO ~  
 UA CLEAR <n u XOF{L v a'd p v d aU  
 fibO ~ UN .

v O d t U p ý d9 'b t U d bO 'u v  
 fibOM øe t U d bu g bO  
 b øe t U d øU a'd UeL u  
 fi+ . t H α bO U/ j { X U 'u p  
 E MHC-GX25 øLMP3 v u øU a'd  
 uG 'v E E vzU E ' øU MHC220 t α  
 fibM U v/ g q U  
 d~A U/ d M . ~UH

·UJ  
 b 'u v U ø' t U d g U U · f · <UL j b j b b U · g U d  
 .bo ~ U f CD <t U d UL ~b g ø'd fibO ð UA "EUM u t PGMçU/ øL ç  
 fi~d v aU bO U/ v U ' p ~ vMO UL t v U~M t U d U  
 v U~M U <b U/ EU& tIO ~ - p ~ t U d q U t U d U  
 bOzU/ v "U 't- øLAOU U p v p v 'd øU t 'b  
 <bOM v "MP3 v u øU a'd UL t v U~M U E fibO ~ UA p ~ U .  
 fi~d v -b-bç ç U U p t p ~ p øL øU a'd U9 øL  
 fib Ed 5gOK d AUç ç U/

fibO ~ U CD 1  
**PLAY MODE 2**  
**DISC 1-3 D.SKIP 3**  
**DISC SKIP/EX-CHANGE**  
 øL dE ~ u aU d t v U >>> U <<< 4  
 fibO ~ UA "EUM u t ~u 'b b d-  
 U + ALBUM - MP3 p øe t U d U~M  
 'b b >>> U <<< f < ~ ~ UA u ' "U  
 fibO ~ UA "EUM u t 'u) v a'd

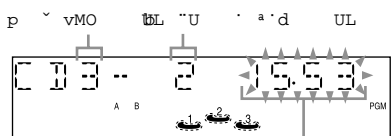

p ~ vMO øL "U · a'd UL  
 g U q  
 'b "U · øU a'd q U α  
 fibO ~ U ENTER 5  
 fi~u v øe t U d a'd  
 v 'b b g q U ' U ~ t E t U  
 fib u

g U q  
 'b "U · øU a'd q U α

bMM OEM  
'd uO α

fibO ~ U **TUNER MEMORY 3**  
fi~u v 'b b d~A U/ ~ XO

XO gO UL



U ~ 'b **PRESET -/+ 4**  
UA "EUM u t 'u)~ XO gO  
fibO ~

fibO ~ U **ENTER 5**

fibOM 'dJ U U~ ' **5** u q dO **6** Ø'd

v ~ rOEM XO

ØU U~ ' f U d ØE v ~ ' u t UA bO 'u v UL  
fibO U/ dO - ' UN ' E rOEM 'u) b v u

FM~ "U ~ U "EUM **TUNER/BAND 1**  
fibO ~ **AM**~ U

Ø'd ~ 'b **TUNING -/+ 2**  
fibO ~ UA "EUM u t 'u)~ U~

fibO ~ U **TUNER MEMORY 3**

fi~u v 'b b XO gO

U ~ 'b **PRESET -/+ 4**  
UA "EUM u t 'u)~ XO gO  
fibO ~

fibO ~ U **ENTER 5**

fibOM 'dJ U U~ ' **5** u q dO **6** Ø'd

~ ~ ~ t ~ ~



U~ - FM Ø'd vzu ~† UU~bo "u v U  
t bO 'u v f UL fibOM/ dXovzu gO  
' ~ p d ØE b XO gO UL  
fibOzU/ rOEM UN U~



pO U u ' rOEM XO

~ t v U U~ ' U9 ØE U ~u r  
ØU f U d f E ~u/ rOEM bM X U  
fibO U/ dO - ' 'u)~ ØU U~

FM~ "U ~ U "EUM **TUNER/BAND 1**  
gO fibO ~ **AM**~ U

UL b v u **TUNING -/+ 2**

Ed f U d g U/ tJO U U  
fibOM U f E t ~ U~  
bM v u U~ ' p Ø'd r O  
U~ ' p ~ t v U~M u fib U/ v  
fi~d v n u pO U u ' u t <~  
Øu d ~ rOEM d~ **STEREO** **TUNED**~  
fib u v FM b ' ~

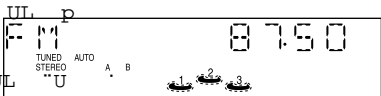

n u u E bA **TUNED**~ t UM  
b ~d~

Ø'd ~ v ~ rOEM XO **2** gO d o UD ' f U d  
fibO U/ XO 'u)~ vzu ~' U~ ' (

u . t .

u  
bo U\$ U s Ø'd

U L < b XO gO U~ . p "U "d o q E F . . u b O . u . v . d U L F . . u p Ø E r OEM  
u vzu . U~ . p t < U~ . Ø L ç v . r OEM X O d g O ç . n O B { U M > O U  
fibO . d fibozU/ U . - † t H a

3 t k d . f fibOM d d Ø d ~ . U~ . . . .  
Ø L >>> U <<< U PRESET -/+ XO gO UL Ø L  
b XO gO U~ . p t u XO gO UL "U . U . u m ' E  
d o - . U~ . U~ . b o ' u v t Ø d E  
XO gO - r OEM fibo UA "EUM u t < b OM

XO gO bMM rOEM tE U . vzu . ØUN U~ . 'b .  
' - † t H . ç vzu . ØUN U~ . XO v U L ç Ø U b OM b AM r OEM t k U d O O G Ø ' d  
fi'bozU/ tE 'sO OKO L t UO LU < t O

t AM ç FM# "U . Ø **TUNER/BAND 1**  
fibO UA "EUM

v d Ø ' d a e , d ' e a K O t AM r OEM t k U  
r OEM t k U d O O G Ø ' d f i x . b U M X O ' e  
u . r O f E A M U r OEM ' p AM ' b . <  
' b ' E T U N E R / B A N D t J O U . v f i b O M u U  
U . J L . t " u v E f i b O . U b ' b t ' E ' Ø l t ~ s O z  
g O A M Ø U U~ . U 9 < b O v d O O G  
s O L < r O E M t k U ' b s O O F Ø ' d f i b u  
f i b O M ' d J q L F . u

U . 'b >>> U <<< **PRESET -/+ 2**  
UA "EUM u t 'u) XO gO  
fibO

XO gO UL f U d

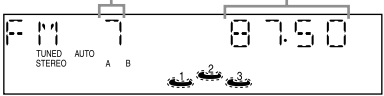

t u  
'AM rOEM t k U b o 'u v/ UL < L d o . vzu  
fibO d O O G  
'UJ  
t J O u . v < E E p d I ' b b t X O g O Ø U N U~  
v U < b H O U H ' d l d U L b o U ' d l  
f i b U b M ' u  
7 ' p U ' u / r O E M ' t L O L { 7 . < ' u ' X  
f i b O U / q E ' v U

°U · r O ·  
(RDS) v u

UH bÄ XO gO U~ · p t  
v ~ rOEM

'v U E · b jI t<sup>α</sup> AM<sup>ç</sup> FM# "U · TUNER/BAND 1  
fibO ~ UA "EUM u

¿X O v u ~ · °U · r O · 'b >> << U TUNING -/+ 2

fibO ~ UA "EUM u t 'u) ~ U~  
v v U d f(RDS) v u ~ · °U · r O  
U 'dL U b ~ v UJ · v u ~ · ØU U~ · t t b U 'UJ  
UNRDS fibMM d U · v U{ · °U · ØU t U d ~ u/UM-O tLOL{ 7 <g 'u  
\*fib U v d FM ØUU U~ · ØE fib U/ q E · Ø U& d ~ q U v  
UFM MODE < ~ FM u d · t U d · t v U  
t RDS UM-O b · 'd rOEM 'ØE d t v U~ 'XOHO · v · E X u b · u 'u E d ~ u d ·  
sJ2RDS <b U nOF{ UM-O t UM U bMJ · U · V · UM u fib U v ~ u N  
fibMJ qL v ~ t X E ~ U A >> << U TUNING -/+ ·  
U 'sOM L <bMRDSv f E d FM' ØU U~ · U<sup>g</sup> fi'pO U u' rOEM α ~ u v n u u ~ u  
RDS r O U UL d · fibMM v/ tz · · U f E d / UH · v ~ u E t j { 'd v · u ~ Ø  
~ u tIDRDS ØU f E d 'UOze ~ u ~ <b · b v UM · fi · t H α  
fibO U/ sO U · vK v u ~ · ØU U~  
ØU b Ø · d MHC-RG220 MHC-GX25 Ø · ä  
'v E E v z U E ·

RDS 'u · X U ~

fibOM "U FM · b · U · U~ · p v ~ U t  
f E d t BOM v rOEM v U~ · ØE UL t v U-M  
fi ~ d v · b b d ~ A U/ ~ URDS · U <b ~ v tz · ·  
RDS 'U · ~ u/ sO U Ø · d  
u t d ~ A U/ <b DISPLAY UAL · t U d  
"bM v dOOG d · u { t Ø · E ~  
X U g ~ \*t U d ← u U ← \* U~ · U  
uK XOF ±  
u E U~ · U <b RDS X u ~ uO \* ~ ut ~  
fib ~ d ~ · b b dJA U/ ~ X · sJ2 t U d

d u o α bMM OEM

u p g

g - u

fibOM UH TYPE LuLFua bo u

u p Ø c ØU

fibOM Ø c ØU 1

U PLAY MODE <r U v t a v E v d g Ø d uB UA a v U

TAPE A/B 1

d~A U/\*'Ø' b : gRELAy ç t v U~M fibO v UA EUM u t v u b b

fibO v UA

fibO v U 2

fibO v UA BUSH 2

fibM v g t Ed u v d t bo v d B UA u v t v u

t v u j { ØE U E g bo u v t fib U uK t X d XL

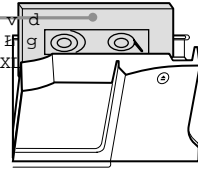

g B a v ØuK Ad a v ØuK Ad g \* bF fi v v n u f E b v d U v d U d U

bo v U\$ . U s . Ø d

fibO v A . g n u

UA v b . tL v s fibO v UA U u n u fib v d d g X U t U bo v

fibO v U L d 7 uK XA d

fibO v UA . PUSHE ØE u v d U

ØbF a d U d { U a d E d tDI Ø d u \*(AMS)

uK t 7 XN

fibO v U L d 7 uK XA d (TAPE B) TAPE A >>> +1 ç

VI t 7 XN

fibO v U L d 7 uK XA d (TAPE B) TAPE A <<< -1 ç

'vIO u pO U uAMS ð M ð

t u

"bMJ qL v v t X s J2AMS v ç j d X% v

fib U tO U d L @M v E v sO bA- j { tK U t v E

fib U t d d u e uK p- p e r O t v E



° u t 'u p ØL  
v

j {- 'u  
p 'u) ØU a'd  
'u p ØL

v j-f

p 'u t 'u d'UM Xto 'u v UL  
fibo U/ j { 'u p ØL v u ' t U d U 'u **CD-TAPE** U eL j {  
q L' b O U/ j { b q L q U L ' b O 'u v SOM L UL u p ØL ' q U p  
fi'bo U/ t' t H ' Ø U O ' q U L fibo d U/ j {  
fibo ' B' q ' j { 1 U 'u p fi'u v roEM U 'u

**GAME TUNER/BAND TAPE A/B CD 2**

fibo ' UA l M "U \***GAME d(MD)** ' fibo ' B' q ' j { 1 'u  
fir O s ' p ' bMM gCD ' j { Ø' d { " ' b O 'u O t vJ **CD 2** ' UA  
fir O As 'u a' ' **TAPE** Ø' d " fiboZU/ Ø 'c~ U ' bOM  
fir O s ' d uO **TUNER** { Ø' d " fibo ' UA ' **CD-SYNC 3**  
b q L v u b L Ø U tK**GAME** ' j { Ø' d " fi'u v 'd B' 'U '  
f**GAME INPUT AUDIO** L/R ØU go t fib v p **REC#**  
b Ø' d **MHC-RG220** **MHC-GX25** Ø' d fibo ' U **REC PAUSE/START 4**  
'v L L v z U L ' ØU

**REC PAUSE/START 3**

fibo ' UA ' **REC PAUSE/START 3** fi'u v 'd B' 'U '  
fib v p **REC#** fibo ' ■ .  
< ' ' UA ' **REC PAUSE/START 4** a'd VO d UB ' j u p ' p j {  
fiboZU/ Ld ' j { Ø' d dE ' u l M g u) f ØU a'd UNM Ø' t U d g .  
fi'u v Ld j { 7 U 6 U q ' Ø L < q ' d fibo U/ j { ' p  
'd j { n u XN fibo ' U' t' H Ø Ø U ' u t U  
fibo ' ■ .

t u  
fibo ' u U- ' d~ ' l UM t bo 'u v/ j { U-M ' v

t J  
"u ' ' j { Ø' d  
Ø' d ' t u d 7 ' < b v u t X ' U u ' ' j { U-M d ' .  
fibo ' X d X ' U g U

'b uK "U

'b rOE

vIO u X dN ' uK "U

'b ~u/ rOEM

~U ' ød u ø'b E ~d X uI ' 'b fibOM

**MUSIC EQ** U\*EQ +/- PRESET EQ  
gO "U ' U ' U "EUM u t UL 'u)~ XO

fibO ~ UA "EUM u t UL 'u)~ XO fibO ~ U**GROOVE**

fi~u v 'b b d~A U/ ~ bt XØ' dõ uJ t d~A U/ <bO ~ v UA ' b

fibOzU/ tE ' ç'b uK s EUM ç ~'u/ "bM v dOOG d ' u

← \*V-GROOVE ON ← \*GROOVE ON  
GROOVE OFF

ØU b ø'dMHC-RG220 MHC-GX25 ø'd

'v E E vzU E ' doOG bMM ~UF vM M <b U v dOOG ' b

'b uK uG ø'd fi~u v s vEGROOVEç UGROOVEç E t U

UA \*ON/OFF U b 'EFFECT ON/OFF

fibO ~

## Sub woofer ' ~UH

ØU b ø'dMHC-RG220 MHC-GX25 ø'd

'v E E vzU E ' ~d @M ULSubwoofer ø'b ' bo 'u v UL

'b uK s EUM ~d @M ULSubwoofer ø'b ' bo 'u v UL

bOM "U ' vDO ØU uK U ' uK p UL d ' fibO U/ ~UH ' 'b l

fi~u v **SURR** ç ç

Sub woofer ØE**SUB WOOFER ON/OFF**

fibO ~ UA

' tifi~d~O s E d~ UASubwoofer s E

fi~u uSubwoofer U ~p~b UA

t J

rOEM ø'd '**VOLUME** UVO L +/- ' bo 'u v UL

~UH ' uK ØU u bMSubwoofer ø'ç t ~ fibO U/

### MUSIC EQ

uK

vIO u ~ 'b U ' l UM ROCK

POP

### MOVIE EQ

uK

vz'uM E ØU XOF u E 'b ØMOVIE

### GAME EQ

uK

vIO u l UMPlayStation1,2 GAME

vzu b E Ø U

t J

U PRESET EQ "EUM ~ ~ UA U bo 'u v som L UL

b ø'd MHC-RG220 MHC-GX25 ø'EQ +/-

U VçGROOVEç **GROOVE**ç <'v E E vzU E ' ØU

fibOzU/ "UEFFECT OFFç

Ø U Ø·b ~d uK vDO uK "U  
·b l UM d U U vzu b Ł

fibO ~ U SURROUND

Ø U - · fi~u v ·b b SURRØ/ ~ φ

fi~d SURROUND U ~·~b UA · tL ~

fibOM "U · · ·b 1 'u)~ l M

fibO ~ U GAME MIXING 2

vzu b Ł Ø U Ø·b g

Ø U Ø·b t ~bo ~v UA · tL ~ UL t U d

"bM v dOOG d · u t Ø· E~ u t

Ø U U -U eL

← MIXING MID ← MIXING LOW  
MIXING OFF ← MIXING HIGH

q Eφα bOM q E U~ ~ t · vzu b Ł Ø

·'bozU/ tE† t H ~ φØ UO · q U E

t u

Ø U · <bozU/ j { t ·b · Ø U · ~u UF fibO U~M UA GAME GAME (MD)

ØE j {φ tk d · bF < uK Ø·b j { Ø·d fi~d v uG

·GAME MIXING ~· t H ~ φv ~· u t ·u p b Ø·dMHC-RG220 MHC-GX25 Ø·đ

Ø·d · b RECØAUSE/START f E ~·~ UA ØU p b Ø·dMHC-RG220 MHC-GX25 Ø·đ  
fibO ~ UA ~d j { t Ed 'v E E vzu E ·

'UJ

b U UF Ø U GAME MIXING d~ UA fi~u v s E pO U u · u t r © < U

fi~d v s E fi~u v "U · pO GAME EQ t

d · v ~u s E U ~ <~d v · UF Ø U U \$ t bM U~M v/ EdO ~ vzu t d XO

fib U v v U UF bM dOOG ·b l M

EOI  
·b

vIO u U b

dL U

vIO u U 7 "u t

· b sOOF gO · U p v vIO u U bO 'u v UL  
fi'boZU/ tE t H' φX U rOEM φa b eO d "u dL-U

fibOM vU 'u g bO 'u v **1** · vUu l'BM · f t bOM rOEM Ø u · r  
p · Ed Ø'd fibO U/ Ø 'c~ U · p t v vIO u U bO 'u v VO d s b fi' u  
φ U 'u t U d 7 U φa bOM tON t U d h A 'a'd fib E "u

fibO 'd U~ 'q' · 'u " 'u fibo v **SLEEP**  
b XO gO vzu · U~ · ØE " UMM Ø tIO v d~ UA <bO v UA ·  
fi'boZU/ tE· t H' φu · t · v · u φa "BM v dOOG d 'u t Ø' E' u

d M U a bO v UA 'b t **VOL +62** Ø'd ·  
fibO U d · **VOLUME** OFF ← 10MIN ← ... ←

U bO v **CLOCK/TIMER SET 3** bO U U t - ' f' U tIO 'u u \*t r O s  
fi' u 'b **DAILY SET** φ fi' d v u U d {U 'u U p 'v φ  
U 'dJKL d U

fibO v **ENTER 4** bO v UA ' tL v s' Ø'd  
pLA t Ed X U d~ UON φ b 'b b φ fi U **SLEEP** \*\* b U v U U so t  
fibM v

fibOM sOOF ' g **5** Ed U tJO U~M U **SLEEP** h tu U U dOOG  
UA "EUM u t X **▶▶▶▶** Ø'd U fi' u "U ' UL 'u) v ' u  
fibO v **ENTER** f < 'v' X U "EUM **SLEEP** t "u dL U 'd U uG  
fi' u ' **SLEEP OFF**

fibM v v pLA t Ed tIO v d~ UA v v U U bO 'u v / < **AUTO** φ dL "u " \*UM' φ  
rOEM Ø'd · E' v **▶▶▶▶** U~ v U U bO 'u v / < **AUTO** φ dL "u " \*UM' φ  
UA ENTER f < 'v' UA "EUM u t tIO v fibO U/ so U ' b U  
fibO v

· g n u **5** UK d qLF 'u v U U\$' U  
fibO U/ sOOF

v u l M U 'v' UA **▶▶▶▶** U t ·  
fi' u 'b b UL 'u) v  
E' u t d~A U/ <bO v UA ' tL v UL t U d  
"bM v dOOG d 'u t Ø'

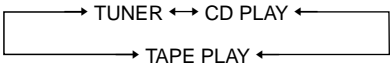

fibO v **ENTER 8**  
l M E <n u U **DAILY** φ dL U' φ u  
v 'b b tO E' d~A U/ 7A U ' q <VO d t v u  
fib 'd

fibO v UA r o b u / **9** d ·

vzu · ØU t U d v U — j { U d U d U  
bo · U\$ · U s · ø'd

p · vzu · b XO gO U~ · CLOCK/TIMER SELECT tL roEM · d so  
fibOM j { b sOOF U fibo · UA  
XO gO · vzu · U~ · b · b · U · UA · v · U · j { Ø'd · u · 'b b  
· t H · φ vzu · ØUN U~ · XO · fibO · φ · bOM · ENTER f  
· φX U roEM φ · bOM XO · X U · L · bOzU/ tE · fibOM l · dK d · roEM doOG  
fib'bozU/ tE t H'

· CLOCK/TIMER SELECT 1 dL U uG  
bOM roEM b XO gO vzu 1 · U~ · ØE d fibo · UA  
t H · φ b XO gO U~ · p t · u · φ · a U · j { 2  
fib'bozU/ tE · u t · u TIMER OFF · ENTER f < · · · UA "LUM

fibO · U · CLOCK/TIMER SET 2  
fib' u v · φ · DAILY SET φ X

u t REC SET φ "U · >>> U <<< 3 fibO U/ UF U eL u t · j { dL · U t  
fibO · U · ENTER f L · · · UA "LUM fibOM UF U eL · d j { dL U · L t ·  
· pLA t Ld X U d~ U · φ · b · b · φ · L dL U < b U s L b XO · gO  
fibM v fib b 'u

fibOM sOOF · j { Ld 4 Ø'd U fib' u v s L b sOOF gO rU O · q  
· · · UA "LUM u t >>> U <<< XO U ·  
fibO · U · ENTER f L

fibM v · pLA t Ld tIO · d~ UA  
E · · · UA "LUM u >>> U <<< XO U ·  
fibO · U · ENTER f

· g n u 4 UK d qLF · u · 5 JL U\$ · U  
fibO U/ sOOF

b XO gO v u · U~ · L < n u U < Ld U  
< U u t · u U\$ · · · b U j { t Ø'  
d~A U/ 7A U · q TUNER FM 5 t 'φ  
fib' d v · b b tO L'

fibO · U · B · d · q · · · j { 6 U · u p

fibO · U · UA r O · d u / 7 KN ·

· · · t · · ·

dL U

d~A U/

bo ~ U\$' . U s . ø'd

d~A U/ ~d u U

'CLOCK/TIMER SELECT 1 roEM ~d so U

fibO ~ UA

U >>> <<<< 2

EdO ~ vzu t d XOF{L ~u RESELECT

f E ~ ~ UA

"LUM u

t v U~M v U tL ~ E d~A U/ d M a d~A U/ fibO lEdK d . roEM dOOG

g U/ E 'bM v pLA E ~u s E X . u U fibO lEdK d . roEM dOOG

~ v dB d 'eO b U q 'b t X . U XOF{L ~u RESELECT

'CLOCK/TIMER SELECT 1 dL U uG

fi~u/

U >>> <<<< 2

tJO U U X . u U r DISPLAY U~M ENTER f E ~ ~ UA "LUM

"LUM u t ~d u X U g U/ U d~A U/ g U/ fibO ~ UA

t u

EdO ~ vzu t d XOF{L uG fibO UF U eL . ~d j { dL U . E t . E  
fibO ~ UA X . u U r DISPLAY U~M UH . U p ~ "u dL U E t . E dL U <  
t ø . E ~ u t d~A U/ bo ~ v UA . tL ~ fL ~ b 'u X d u E "u dL U <bo

d~A U/ <Lb X U g~U/d~A U/ ~ g U/ fib U v qOKI q 'b t j • { ~

'EdO ~ vzu t d XOF{L a ~ ~ g U/ bo U ~d roEM . X U \*UL t v u ~ jI X U

fi~u v

t u

U\$' EdO ~ vzu t d XOF{L ~ d \*UOKL bo 'u v/ UL

fibO ~

X U roEM

<tO E <v U E . øU AM roEM eK U dOOG

'sO OKO E t UO EU

~dJKL øU tL ~ ~ ~ UA # r O ~u/ s E

t J

fib ~ v t ~ ~ U t EdO ~ vzu t d XOF{L ~ dL U

'p ~α U 'uM E g q U p s o ~ u t u d ° U  
UA n u XOF{L ~ "EUM **DISLAY**  
fibO ~  
t Ø' E~ u t d~A U/ bO ~ v UA U. d{U ~ a' d t h U d v U U E g  
"bM v dOOG d ° u fibO U/ sO U

fix ° Ø~U g XOF{L ~ p ~ t v U~M  
u ° q ° \*p bF~ Uu ° q \*TOC B I ~ A U/ **MP3** flp ~ α b U v U U ~ u,  
'tO, U' b Ø' d α X U ~ t g w/ ~ t d {U  
uK XOF{L UA "EUM u t Ø~U **DISPLAY** ~ °  
ØU a' d q ~ bF < d {U p ~ **TOC** \* ~ U u E b "  
fib ~ v g U/ ° p ~ g q U E t < p Ø' Ø E L ~ u t d~A U/ bO ~ v UA  
sJ2 U u **MP3** ~ M u < ØU a' d U Ø p ~ Ø' d "bM v dOOG d °  
fib uA ~ ~ g U/ g XOF{L t t X °

t u p ~ p Ø' d g q b U U ~ U d {U U a' d g ° b Ø d  
~ ~ **MP3** v u ØU a' d U p ~ p Ø' d g q ← \* p ~ ° b U ~ \* U {U U a' d  
fib ~ v - UJ ~ u ID3 ~ V N M ° uK XOF{L 'tQ U b Ø' d α X U g U  
< b U ID3 ~ V d p BOM v **MP3** U L U t d ° - U ° d ° gO q U Ø' t U d - g - ° \* U - M ~  
fi~u v ~ ~ g U/ a' d ID3 ~ M d ° t u t ° fi~d v ° b b t IO  
sJ2 a' d b U LO U U E g ° b Ø d ° U b Ø' t U L D y S C S U X O F { L ~ - - - ° \*  
"b uA ~ ~ g U/ v ~ t X ° fi~d v  
'dOG X U V B R d α **MP3** q U p t v U ~ M >

fi~u v ° d ° l d XA d U l d 7 u N E t E v ~ M E > ° **MHC-GX45/GX35/RG440S/RG330/ jI** ■  
° b U ~ U d {U U a' d g ° b Ø d  
'u ~ \* p ~ ° b U ~ \* U {U U a' d  
← 'tQ U b Ø' d α X U ~ g u U / ~ \* ° d  
uK XOF{L  
- U ° d ° gO q U Ø' t U d - g - ° \* U - M ~  
fi~d v **MP3** b u ØU a' d U t IO  
a' d g U ~ M U ° A L L D I S C S X O F { U ~ \* ~  
fi~d v ~ - b - b ° **MP3** v u ØU  
U - f i t - o t ID3 V d U a' d p U L t v  
V d fi~d v ID3 ° b d < b O U / v l - g °  
fib ~ v g U/ ° a' d IDM ° U °

d~A U/

· u ~ · ~

d000

**MHC-GX45/GX35/RG440S/RG330/ jI α**

· vZU · ~~MHC-RG220~~ **RG310**  
' ' v ·

fibO ~ **ILLUMINATION**

t Ø' · u t 'u <b0 ~ v UA ·  
"bM v d00G d ' u

**MHC-GX45/GX35/GX440S/RG330/ Ø'd**

**RG310**

← PATTERN 3 ← PATTERN 2 ← PATTERN 1

← PATTERN 5 (FLT) ← PATTERN 4

'd~A U/ ~~PATTERN~~ OFF

'v · · vZU · **MHC-RG220** Ø'd

'd~A U/ · b ↔ usUE



d · dL b tz · √ d U ØU qLF · u √ t fibOM qB · t · Ø UO · q  
fibOzU/ tF · d tK

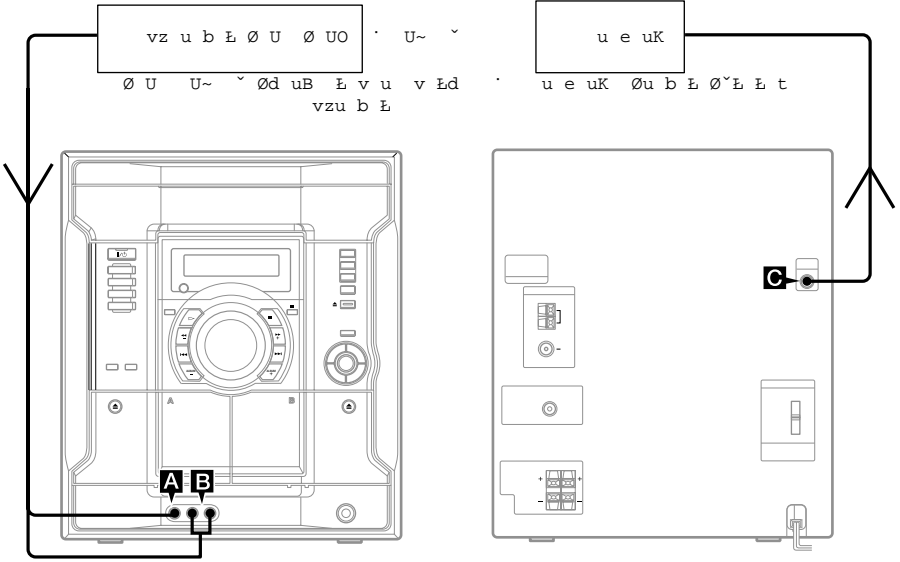

Ø UO · q

**GAME INPUT VIDEO go A**

r O b uU · u √ v vzu b E Ø U u U · √ d UB · Ø · d 'X O tLOL{ t a  
fi' u · b b u e uK t H ØE X · b · E √ d UB · Ø · d 'X O tLOL{ t a  
Ø · b ØU uK · √ ut H · √ √ vDO uK · U · √ fibOzU/ √ UH · go s · t vzu b E

**GAME INPUT AUDIO L/R ØU go B**

UA · b GAME X · u U r O tJO √ √ UL d ·  
fib U v GAMBGt · d U E b s E r O v · b · d UB · Ø · d 'X O tLOL{ t a v u  
v d GAME EQ t pO U u · u t eO bMM · UH sOMJL go s · t vzu b E Ø U Ø  
fibM v u v E d r O s · od · bO · u · v

**VIDEO OUT go C**

UGAME (MD) X · s E r O tJO √ √ UL d ·  
√ UF E tGAME dOOgd U < bGAMEA ·  
fibM v GAME EQ t pO U u · u t bMM  
Ø U b Ø · d MHC-RG220 MHC-GX25 Ø · d  
' v E E vzu E ·  
Ø√E E UB · Ø · d 'X O tLOL{ t a u  
fibOzU/ √ UH · go s · t u

fi'u v uG dL U flu ' XO gO  
"bo ~ ° u\$ : ' d • ØU U  
' , t H α φX U rOEM φ  
- ‡ t H α φvzu ' ØUN U~ - ' XO  
† - t H α φrOEM ' d sO U φ  
† - t H α φvzu ' ØU t U- d v U

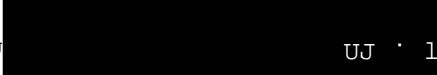

UJ ' 1

gO φ U q ' L ° JA

fib v/ u t vz'b "bo U/ qL  
U~VOLUME d M U VOL +UA ' t L ' O d t u bMK ØU rO 1 LdO rO  
fibO U d X U ØU t dI XN fibM U b q E rJ u  
fibM U v/ qB U v u • t b u s LD  
fi t H α bo U/ sO U • u bMK • U L t U d ° UJ ' sO U 2 X O ' v  
fiX ' b ' u ' u E ' b v Ed v • U j { U~M ' fibO ' U\$ ' ' b h A v ' .

fibM O @M UL X ' E Ø' b U b ' v U U p ' UNM fibO U/ ' uA ' u v u e d s c  
fibOM v U/ U UI ' u t ' UJ ' b U ' U u bMK  
fibO U/ q E ' tLOL { ØU u bMK b v pL ( ) d~ UA t v U~M

fib ' v X ' ' ' u , x fibO U/ sO U ' d ' u E t° U U e  
b q E ' O u t E u O M K gO t bOM d M d X ' b ' ' d ' O U E Ø E d U  
fibM U d~ U ' t bOM q U UMOL ' f < ' u/ d M  
fix ' b rOEM v ' t U

fiX ' X ' U U E r ' ' b t ' b ' b U u UB ' u bMK > E < Ø  
fibO U/ E ' X ' U d M ' ' r b O ' ' u/ ' UH ' b n O u gO • ' ØU u k  
fibO U/ q E Ø d ~ ' Ø ' u ' v • Ed t ' X r ' O ' u/ ' E b ' r O X A ' t u N ØU ' .  
' u t d ' q U α X ' U d KO p v K < Ø ' j t E d ' u/ Ed d E u ' u ' v  
fibO U/ VB ' Ø U & d ' fibOM s E ' r ° O ' u/ E d L r O

fi'u v/ rOEM dL U sO U ' f v tK d ' U < b e O pL  
fi t H α bo U/ brOEM X U Sony Ed bM U/ s d J ' e U ' u v/ t  
fibOM ' uA ' u

fibM v/ qL dL U  
bOM rOEM ' ' O U E ' u sO U ' dL U ' ULOEM ' UOK  
fi t H α bo U/ uG ' ' u dL U U~ d U UL tJM ' U bOM v q E EdO l M t ' E  
5 tK d U bM v ' pLA t Ed d~ A U/ < b ' d

fibM v/ qL E ' ' d M U~ ' fi' bOMO ' ' t H α φ r O ' d q  
fib ' d ' ' l U UA U DISPLAY X ' u U r O tJO U ' v  
fibO U/ d J ' e r O t ' • E ' ' d M U~ ' fi' d v u g U/ fibO ' v  
fib dO~ t UA r O u M Ed t • E ' ' d M U~ d v ' b b d~ A : U ' φ  
fibO U/ i R5/AA ' ' b ' a U Ø d U dL U , E H α X U rOEM fiX ' ' U • UH ' vzEd  
fib ' ' U~ E ' U uz u K u ' ' r O fibO ' U\$ ' † ‡ t H α

fi' ' ' u E ' b X A d X U  
fib E U O s O z U ' ' b t ' v

fi u e u K t H @ ' v~M UL U ' U ' .  
s E ' d † t E O ' f E ' u/ u U ' U J ' u e u K  
< X ' ' ' u E U M L u e u K @ ' v~M UL U d ' fibOM  
fibOM d ' U u e u K ' U u bMK tK U

\*fib u g bM MP3 v u ØU a'd

UJoliet † 'd- UISO 9660 X d o † j {

fix ' bA U\$' ~RomeoX d

fi' ~.MP3 † b uMP3 v u a'd

fix ' bA MEO X-d t 'U

ØU q U ' dO Ød~ ØU q U ØEU ØU p ~

fib u g bMPEGLAudio Layer-3

t X Ød ~U U MP3 v u ØU a'd

\*fib ' ~ UO U q U d U

qK t <b 'u v ' p ~ ØE ØU a'd

t ' ~ UO v uLF b ' d 'U U t X ' sJ2 g d

"b U

fix ' ~U UO p ~ ØE ØU -a'd U U ØE U f ~ BF

fix ' bO O UO u- ' E a'd U U fibO U/ UA p ~ b U Ø'd

v/ 'b b 'O ' ID3 v d E a'd 'uM < u ~ uM

\*fib u

Romeo UJoliet † 'd ISO 9660 U t vJ •

fibOzU/ ~UH ' bU t ' ~ o UD 'd X d ~

fib U ~/ U/ t -at 'ID3 v d •

EMHC-GX45/GX35/RG440S/RG330/RG310 jI\*

'v E E vZU E MHC-RG20

'd uO a bMM rOEM

XL t ' 'b Ed t bo ~ 'd • vMO

fibM O X U ~ q U U U~ ' X ' U U Er ~ 'b t Ø'b

fi† t H a bo U/ sOOF ' V • UM f U df E bOM aU ' 'D ØE X u E t

fi• t H a bo U/ q E 'O • d t ' X ũ ' U bo U/ U s E X U t X U bM

7 ' f <t U b U/ v d o ' "u • X U ~ t ' v N E q

"u X U ~ ' E' X b t fibO ~U/ U d ' fibO ~ UA g

t d ~ q U v U 7 ' p rOM v tO u U <bo U v/

fibO U/ q E ' Ø U& ' u

X U ~ 'u u U9 ~ ' FM v DM-Ø <t LOL {

fib ' ~u/ u q U u t ' d ' t b u s LD s 'd UM fibM v fibO U/ i uF • p

fibO U/ E ~ u bMK ØU rO • UJ • b d U' U u 7 t a d E b vK • t ' r

fibOM u U ' Æ'd ' ~ vJ d • J ' tKO E bo U/

ØE d ' U ' U <bOM E ~ r Ø ' ' U

~ ~ t ~ . , 'u ' U a'd p UL t v U-M fibO ~ 'd

Y U X ' sJ2 u bMK d <bo U/ v u bMK

fib ~ d

fi' u v/ Ed a'd sO E' ' g

E RGM † ØE ~ d b uPLAY MODE •

U Ø'U g U t U bo SHU† ~EUM

fib ~ d

T . DU

U UO

fix O u d · X U t xFM u'at · tuU d  
MHC-GX25 Ø STEREO/MONO UFM MODE ·  
'y E E vzU E ' ØUMHC-RG220 Le t a  
< U~ U U~ MONG b u U  
fib d-A U/

ØE X · sJ2 d ØU UO · vJ  
fibM e pLA U E b

MP3flp ~

NO DISC

fi' b ~ u E bMM g q ~ vJ

OVER

t b · ~ ►► UA u' n u U g  
fib · bO p ~ ØUN

fix · b t U 'b t ~ U E ~ u v g t E j  
fi‡ t H a bO U/ eØØ ' H O · 'U b  
fo UMG · b · ~ d 'bo v O UMG · U g flj {  
~ tJO U ~ fi‡ t H a bO U/ v ~  
ØUN

fi' u v/ 'aU q U u t 'u  
fo UMG 'b U ~ d 'bo v O UMG ~ g flj { Ø  
fi‡ t H a bO U/ v ~  
t d p 'b U E ~ u v ~ U bM 'e u t 'b  
fib ' v sOzU  
bO U/ eO9 bM U nO' 'u g O E dO ØU p U  
fi‡ t H a

fib u v 'aU U ØU f U d U t U g ·  
fo UMG · U ' b · ~ d 'bo v O UMG U g  
fi‡ t H a bO U/ v ~

fibM v/ j { 'u  
fibo U/ Ø 'c~ U · X U p fix · bA Ø 'c~ U  
V 'u U · b t J t fix · b ~ d 'b  
fi‡ t H a bO U u  
fix · bO UN · ' t 'u

V UM u t uM u 'U 'b · U\$' · f  
"bo U/ rOEM U d 'u t ' r O <  
fibOM U e d 1 · · Edo  
fibOM q' b · E2O rO  
fibo ~ UA IZOLATION GROOVE ■ 3  
fibo ~ UA r o b I/d 4 Ø'd :  
fi~ d v U X · b rOEM t U U ~ t  
ØU U~ · qO · ~ u j u b U\$' 'U  
fibo ~ U\$' · · dL U E <X U <

^dJKL ^ u

U E ^u ^ E' d q p ULOI ^d rj ^Opd  
eM ØL X u X ^sJ2 <b U t ^ d  
sOM Ed ^ u ^ fi^u UFO p ^ bMM g XL q ^  
p ^ X U s ^ u ^ fi^d b ^ u qL V UM XOHU U r O v UH ^



v U { . ^ U

^ U UO

U s E ^ u t X U p ^ Eb Ø^d ^ r O E ^ d U ^  
fibOM U ^ . . . U p ^ U9 ^r O ^ d U t U U-M ^dJKL U E ^ u  
t UA UL r O ^dJKL U E t BOM d M  
^dHd <b ^ ^ u r O U U ^ . ^ Ø^tk U E ^ u t u d fibU vK ØLdO l M  
fibOM ^ Soay Ed bM U / s d J ^ e U ^ ^ u

U p ^ t l ^ v dUJ v ^ X ^ qB Ø ^ u ^ v Ed ØLdO l M t  
e d ^ . . p ^ fibOM e09 nOEM t U p U fibO ^ b ^ qLUM ^ ØLdO l M ^ b U u  
fibOM e09 EdO XL ØLdO l M ^ d ^ <BOM v / ^UH ^ r O  
U U dOE v ^ d l UM U bO u rOI l u M dF e d ^ 7 q ^ U ^ r O U s ^ Ø^d fi  
u ^ b ^ a U sO U q ^ ^ d ^ E b o b ^ d ^ . . Ø ^ fibOJ ^ r O ^ u e d fibO

^ v d Ed ØL t BOM v ^UH ^ v U p d ^ b t ^UH ^ t u d ^ q L ^ d l ^  
V d t v UN ^ U b ^ Ød ^ t UA bM ^ U U v p fibozU / sO U ^ u ^ U  
^ u L UL ^ s ^ <X ^ t U t UN ^ v d uFu U ^ v ^ U U dOLF AC ^ EJM v ØLdO r O  
fib U ^ s ^ vK ^ ØU XL t V d U p ^ t v ^ u  
LbI X ^ sJ2 p ^ 7 ^ d U ^ UH ^ Ø ^ v SOM t v U-M  
q fi^u U ^ ^dJKL ^ u Y U X ^ sJ2 eO E ^ b U ^ r O ØdO ^ d q ^ u

fib ^ d s LD p ^ ^ V d Ed ^ u bM ^ UH fibO b ^ d ^ VO q ^  
" b dO ^ d ^UH ^ u v U d p ^ u : b o b ^ d ^ d ØU q ^  
t Ø^ b ^ ØU v d U qLF - E Ø^ t ^ d ØU p ^ ^ d U d ^ b t  
V d u ^ dO fix ^ t ^ d ^ d V d ^ u ^ UN ^ V no U ^ u ^ aU  
fix ^ bM p ^ ØL ^ U vKO X-u U

V d ^ ^UH ^ U b U ØU V- d Ø^ ^ ØU p ^ ^ d dF ^  
fi^u v ^ u bM U ^ f\* U-M ^ t v uB fibO u rOI u- dF ^  
U vF d <qJ vK < U u t a ^ . b U ^ ØOKUJ t U v ØD pØL U u bMK U ^ ^  
U s ^ U\$ ^ Ø^d fibM O g q U r O U s ^ ØØL ^ ØI ^ UO E ^ <s L ^ <f ^ E ^  
^UH ^ v U p ^ sOM ^ fi^d b ^ E v s d2 t ^ dM vX ^ sØ2 U b tJ ^ U bO U /  
fibOMJ fi^d ØdO uK ^ u q U X ^



v U { . ^ U

^ . . t ^ . .  
^ d lL & ^ u ^  
v ^ d vMF t s ^ U ^ fibM v bO u ^ d  
fix O U ^  
V UM t uN U vzU ^ d ^ < U ^ ^ . . .  
fibO ^ d

^ t b ØU ^ <BOM v ^UH ^ U ^ bMK  
Ø^d fi^L v U Ø^ tE q U ^ eO t ^  
fibOMJ f\* ^ U ^ ^ t b ^ <v ^ u  
bMM pM s t uN cHM ^ r Ø ^ v ^ d  
fibO U u

# °UB A

U~ ^ XMO U ^d eO9

bM u ^u uK U vL t t U p U ^ U  
 ^u < bM U s pA u O ^ fibO U/ eO9 X ^  
 fibOMJ ^UH ^ qJ ^ U eM <dMO dOE

"v UL ØUJ d ^ ØU b ^u p vLz ^v kH XN

## MHC-GX45

Æd ^ X U ^u t < ^u p ØE t ^u U j  
 fibOMJA X ^ b ^v^ UA d B qA ^ t vL

uK Øu bMK

"l dRMS t uO ØEdO v Ed

p ^ ¼ " ¼ «†  
 THD ¥ <e d uKO  
 p ^ ¼ ^/• ^ d L v u U Æ ^ q  
 ^ ¼ «e d uKO

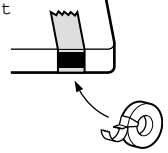
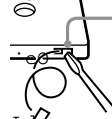

Sub woofer

"l dRMS t uO ØEdO v Ed

<e d ^ ¼ " ¼ «†  
 THD ¥  
 ^ ¼ ^/• ^ d L v u U Æ ^ q  
 ^ ¼ «e d

ØEo bO ^u v <bOM ^UH ^ ^b ^bF {dKN ^u  
 fibO U u V ^u U ^ b t

## MHC-GX35

^u a^ ^ X U ^u ^v^ ^d

p ^ ¼ " ¼ «†  
 THD ¥ <e d uKO  
 p ^ ¼ ^/• ^ d L v u U Æ ^ q  
 ^ ¼ «e d uKO

EdsJ2 <^ uBM ^dO ^ fibOM ^b ^ ^ ^u  
 fi^d ^ v ^d Y U E ^d do ^u a^ ^  
 ^eO bOM v ^UH ^ tIqO^ ^u ^ t v U~  
 qO ^u ^d U s ^d UM fix ^vU UO  
 U s ^ fibo b dOOG ^EUM u t ^ l d g  
 fi^d a^ ^ ^u ^d do Y U X

## MHC-GX25

"l dRMS t uO ØEdO v Ed

p ^ ¼ " ¼ «†  
 THD ¥ <e d uKO  
 p ^ ¼ ^/• ^ d L v u U Æ ^ q  
 ^ ¼ «e d uKO

^u ØU b ^d eO9  
 q U UMOL ^ fibOM eO9 ^ ^u ØU b ^ f ^UH  
 ^eOvL b ^u p g ^bF U E rN j { p E  
 u U pA u ØU ^u ^ U s ^ Ø^d fib ^  
 ^UH ^ b u v t Ed b ^d eO9 Ø^d t U ^  
 fibOM tF ^d bMM eO9 X U qLF ^u ^ t ^U

^u ØU b ^ vz ^v fo UMG

t t ^v fo UMG X U p tKOu d < ^UHf ^ X U  
 ^ t ØeK ØU XL E ^u ØU b ^ <^u v t  
 t <^UOze ^u ^ fibOM vz ^v fo UMG b  
 fibOzU/ tF ^d ^v fo UMG X U ØU q

"U b d U

"v E L vZU E ' ØU

**MHC-RG330**

**MHC-GX440S**

E X E. †† < -†† < "EUM U d ~ d d ~UI

uK Øu bMK

b' b ØdO /|b' e d

"' b v DIN ØEdO v Ed

p ~ "E +-

"DIN <e d uKO

"DIN <e d uKO

"'l dRMS t uO ØEdO v Ed

p ~ "E +†

THD ¥ <e d uKO

THD ¥ <e d uKO

THD ¥ <e d uKO

**MHC-RG220**

Sub woofer

E X E. †† \-†† < "EUM U d ~ d d ~UI

"' b v DIN ØEdO v Ed

b' b ØdO /|b' e d <e d

"DIN

uKO p ~ "E +,

"'l dRMS t uO ØEdO v Ed

"DIN <e d

THD ¥

"'l dRMS t uO ØEdO v Ed <e d

THD ¥

p ~ "E +-

THD ¥ <e d uKO

THD ¥ <e d uKO

THD ¥ <e d uKO

U Ø~E E

**MHC-RG330**

"'u u ØUGAME INPUT AUDIO L/R

"' b v DIN ØEdO v Ed

<X E vKO † E

p ~ "E <

r' uKO f' b

"DIN <e d uKO

"'u u ØUGAME INPUT VIDEO

"'l dRMS t uO ØEdO v Ed

r : Vp-p-

p ~ "E -† < -†

U v Ed

THD ¥ <e d uKO

u d ACØU E r' u d ~ p PHONES

p ~ "E † < †'l d Ø v IO u 'u v E

bM v

THD ¥ <e d uKO

Vp-p- v Ed t ~ d "'ubu VIDEO OUT

THD ¥ <e d uKO

f' b' <vHM v U eL < UI U

**MHC-RG310**

r : U

"' b v DIN ØEdO v Ed

'SPEAKER

p ~ "E <

bM

"DIN <e d uKO

"'l dRMS t uO ØEdO v Ed

EMHC-GX45 jISTB WOOFER OUT

p ~ "E <

THD ¥ <e d uKO

v u ~ f' b' "MHC-RG440S

p ~ "E † < †'l d Ø v IO u 'u v E

THD ¥ <e d uKO

bM

**MHC-RG220**

"' b v DIN ØEdO v Ed

p ~ "E <

"DIN <e d uKO

"'l dRMS t uO ØEdO v Ed

p ~ "E † < †

THD ¥ <e d uKO

p ~ "E † < †'l d Ø v IO u 'u v E

THD ¥ <e d uKO

v U { . 'U

~ ~ t ~ .

u BMK

p ~ bMM g XL

v u r O E ~dA p ~ r O  
U O ~  
øV tLO eO eO

**MHC-GX45/GX25** Ø·SS-RG440 ØuK Øu BMK

<b 'E< †' u BMK r O  
'bass-reflexα , "U U u  
u BMK ØU b 'E  
v Ed u <d-† v U "Woofeer  
v Ed u <d-† v U "Sub woofeer  
v Ed u <d v U "Tweeter

t uO "UA ' 'b  
e d uKO e d a U f U d  
± / dBα  
·, -·" nm u u  
" dB 'gO X ' U t UM-O X  
" dB 'gO pO UM ~ 'Eb

d vKO †† "†† dI 'UMN flØBMK floL α ~UF  
d Ø' ' t ./-Ø uKO  
u BMK

'u a~ XL

a' d t ū Øu d ' j { r O  
<±†dBα e d -†U a U f U d  
X U ~UH ' U

Ø·dSS-WG990 Sub woofeer Øu BMK

**MHC-GX45**

'bass-reflexα , "U U u u BMK r O  
u BMK b 'E  
v Ed u <d† v U "Woofeer

Sony TYPE I  
± ¥/- W.Peak (IEC)  
¥/-W.RMS (NAB)  
± ¥/†W.Peak (DIN)  
d E tLNL

d vKO †† ¥ Ø dI 'UMN flØBMK floL α ~UF  
d Ø' ' t ./-Ø uKO  
u BMK

'd uO α bMM rOEM XL

FM/AM superheterodyne bMM FMØu d

FM 'd uO α bMM rOEM XL

"v ~U U b

**MHC-GX35** Ø·SS-RG660 ØuK Øu BMK

<b 'E< †' u BMK r O  
'bass-reflexα , "U U u  
u BMK ØU b 'E  
v Ed u <d- v U "Woofeer  
v Ed u <d- v U "Sub woofeer  
v Ed u <d v U "Tweeter

e d U-/- -- / v E ØU b  
' 'b 'u E u d ' X U α  
e d U-/- -- /  
e d U-/- -- / U b d U  
FM v d 7 ' 7 ' 7 ' U

r · UI b 7 ' ØU UMO d  
e d U-/- j E b f U d

AM 'd uO α bMM rOEM XL

d vKO †† ¥" Ø dI 'UMN flØBMK floL α ~UF  
d Ø' ' t ./-Ø uKO  
u BMK

e d uKO >-· "sJ d ' U b  
ØE b SOOF rOEM tK U U α

'e d uKO

e d uKO>-·-

ØE b SOOF rOEM tK U U α

'e d uKO

"sO OKO E t UO EU <v E <v U E

e d uKO>-·†

ØE b SOOF rOEM tK U U α

'e d uKO

"U b d U

ØE b SOOF rOEM tK U U α

'e d uKO

e d uKO>-·†

ØE b SOOF rOEM tK U U α

'e d uKO

AM Ø' tIK 7 ' 7 ' 7 ' UMO d 7 ' ØU UMO d  
v U 7 ' UMO d 7 ' ØU UMO d  
e d uKO j E b f U d



MHC-RG220 Ø SS-RG440 ØuK Øu bMK

"v E E vzU E ' ØU

<b 'E< †' u bMK r O  
bass-reflexα , "U U u u bMK ØU b 'E  
v Ed u <d-† v U "Woofers  
v Ed u <d-† v U "Sub woofers  
v Ed u <d- v U "Tweeters  
d vKO †† "†† dI 'UMN flØbMK floL α vUF  
d Ø' t /-†† udKO E

Ø'dSS-RG440 ØuK Øu bMK

MHC-RG440S/RG310/RG220

<b 'E< †' u bMK r O  
bass-reflexα , "U U u u bMK ØU b 'E  
v Ed u <d-† v U "Woofers  
v Ed u <d-† v U "Sub woofers  
v Ed u <d- v U "Tweeters  
d vKO †† "†† dI 'UMN flØbMK floL α vUF  
d Ø' t /-†† udKO E

"UOK

UO v u ' b

e d¶ <"EUM -†E E " v UL ØUJ d' ØU b  
e d fl¶ <"EUM †E E "v E E vzU E ' ØU b  
<"EUM †E E† " v UO 'd ' ØU b  
e d ¶ fl ¶ <"EUM †E E " sO ' ' ØU b  
e d ¶ <"EUM -†E E " vJ eJ ØU b  
††>†· U†fl-†>†· " Ø~UF U d b  
e d fl¶ <"EUM X E d vKO "†††† "Ø dI 'UMN flØbMK floL α vUF  
U E d~ U ' U rOEM q U d Ø' t /-†† udKO E  
U XtE <X-† " U b d U  
<"EUM †E E† u bMK  
e d fl¶  
U E d~ U ' U rOEM q U

Ø'dSS-WG990 Sub woofers Øu bMK

MHC-RG440S

bass-reflexα , "U U u u bMK r O  
u bMK b 'E  
v Ed u <d- v U † "Woofers  
r ¶ v U f 'b '·  
d vKO "†††† "Ø dI 'UMN flØbMK floL α vUF  
d Ø' t /-†† udKO E

MHC-RG330 Ø SS-RG660 ØuK Øu bMK

<b 'E< †' u bMK r O  
bass-reflexα , "U U u u bMK ØU b 'E  
v Ed u <d- v U "Sub woofers  
v Ed u <d- v U "Woofers  
v Ed u <d- v U "Tweeters  
d vKO †††† "Ø dI 'UMN flØbMK floL α vUF  
d Ø' t /-†† udKO E

v dB 'u  
" UJ d ' b U ' ØU  
"MHC-GX45  
"MHC-GX25  
" v 'U U ØU b  
"MHC-GX35  
"v E E vzU E ' ØU b  
"MHC-RG440S

X E-  
X E-†  
X E-†  
X E-  
t d XOF{E v†'·E  
'EdO v u  
X E-† "MHC-RG330  
t d XOF{E v†'·E  
'EdO v u  
X E-- "MHC-RG310  
t d XOF{E v†'·E  
'EdO v u  
X E, "MHC-RG220  
t d XOF{E v†'·E  
'EdO v u

MHC-RG330 Ø SS-RG660 ØuK Øu bMK

<b 'E< †' u bMK r O  
bass-reflexα , "U U u u bMK ØU b 'E  
v Ed u <d- v U "Sub woofers  
v Ed u <d- v U "Woofers  
v Ed u <d- v U "Tweeters  
d vKO †††† "Ø dI 'UMN flØbMK floL α vUF  
d Ø' t /-†† udKO E

" U b d U  
"MHC-RG330  
"MHC-RG220

d vKO †† "·Ø· dI 'UMN flØbMK floL α vUF

v ·· t ···

v U { · · U

			E
		"v UL ØUJ d	ØU b
d	uKØØ	dI	HCD-GX45
d	uKØØ	dI	HCD-GX35
d	uKØØ	dI	HCD-GX25
		"v E E vzU E	ØU b
d	uKØØ	dI	HCD-RG440
d	uKØØ	dI	HCD-RG330
d	uKØØ	dI	HCD-RG310
d	uKØØ	dI	HCD-RG220
		"U b d U	
d	uKØØ	dI	HCD-RG330
d	uKØØ	dI	HCD-RG220

-α E~ · · d M U~U~· · dL rzUL{  
 '†α U Ød U  
 -αAM Ø' tIK 7 '  
 -αFM v d 7 '  
 u bMK ØU p A U

MHC-GX45/RG440S

-†α  
 MHC-GX35/GX25/  
 RG330/RG310/RG220

'α

fibM U dOOG vK · E b X · sJ2 U~ ·



U tL ~ nO u

vzU H ~ VO d

- |                      |                    |                       |
|----------------------|--------------------|-----------------------|
| 13 'Ø U a B a PUSH ▲ | 23 REC PAUSE/START | 15 *ALBUM +           |
| 15 'n U a B          | 26 TAPE A/B        | 20 *ALBUM -           |
| 16 d l d 7 ▶▶▶       | 27 TUNER/BAND      | 28 CD                 |
| 15 '7k ,▶▶▶          | 4 d-A U/ d M       | 24 CD SYNC            |
| 20 'g ▲              | 21 A a v           | 8 DISC 1-3            |
| 20 'XA d-▶▶          | 3 E ~ d M u M      | 9 DISC SKIP/EX-CHANGE |
| 20 'V D t X▶▶        | 7 p ~ ødO 'd vMO   | 2 DISPLAY             |
| 22 'Ø U A t ▶ PUSH   | 17 PHONES gO       | 11 EFFECT ON/OFF      |
|                      | 19 L/R             | 12 GAME EQ            |
|                      | 18                 | 12 GAME MIXING        |
|                      | 5 'u               | 12 GROOVE             |
|                      | 16 VOLUME d M      | 12 MOVIE EQ           |
|                      |                    | 12 MUSIC EQ           |

MHC-GX45/GX35/ jI\*  
 £RG440S/RG330/RG310  
 £ vzU £ ~ MHC-RG220  
 'v £

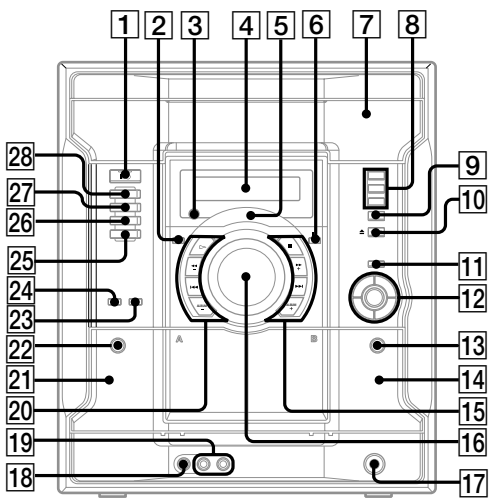

MHC-RG440S MHC-GX45 jI Sub woofer

v U H ' VO d

-,a 2 SUB WOOFER ON/OFF

1 d~ UA

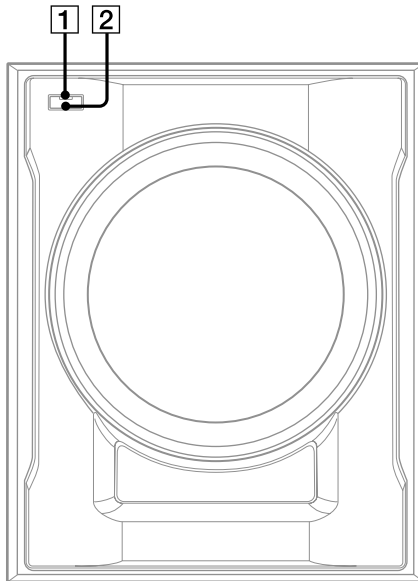



U tL ~ nO u

vzU H ' VO d

↑, ↓, ←, → □4

5 'XA d fl l d 7

'VI t XA d fl 7

↑, ↓, ←, → □5

↑, ↓, ←, → □5

↑, ↓, ←, → □5

↑, ↓, ←, → □5

**Z - O**

□16 ON/OFF

□21 PLAY MODE

□5 PRESET -/+

□8 REPEAT

□1 SLEEP

□8 STEREO/MONO

□11 SURROUND

□9 TAPE A/B

□18 TUNER/BAND

□17 TUNER MEMORY

□5 TUNING -/+

□12 VOL +/-

**N - A**

□19 CD

□20 CLEAR

□2 CLOCK/TIMER SELECT

□3 CLOCK/TIMER SET

□6 DISPLAY

□7 D.SKIP

□15 ENTER

□14 EQ +/-

□10 GAME

□13 GROOVE

