

What's in the box
盒中內容

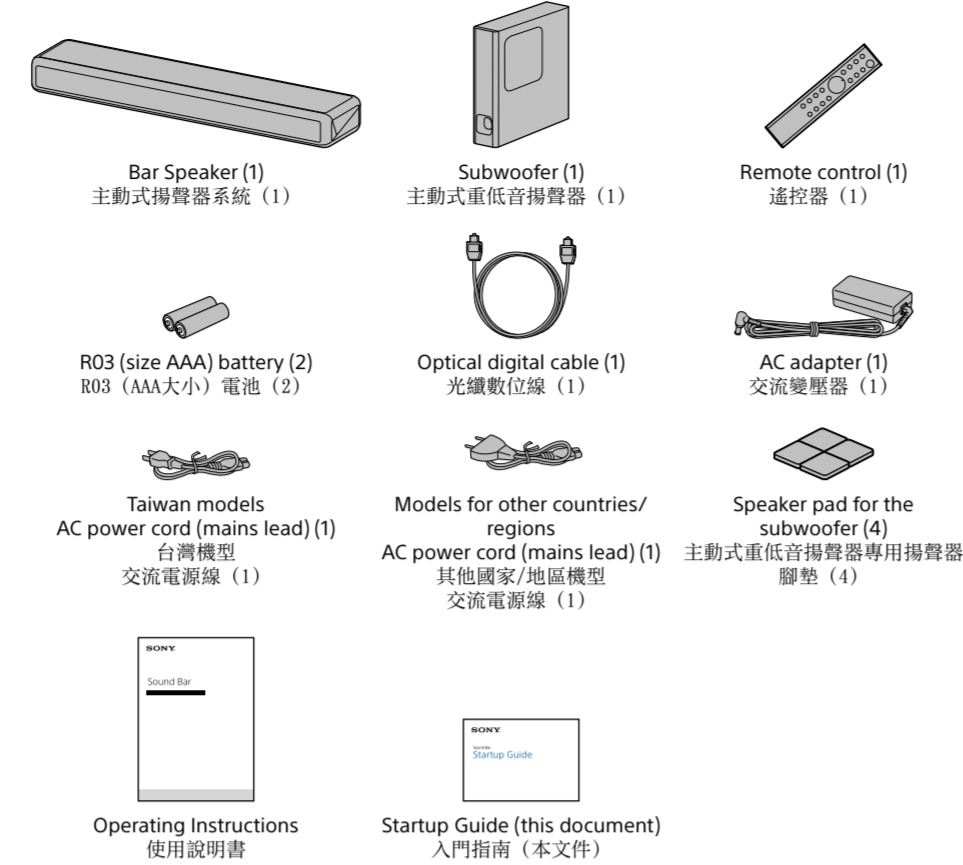

To set up the remote control
設定遙控器



1 Connecting with a TV
連接電視機

Is there an optical digital jack on your TV?
電視機上有光學數位插孔嗎？

YES/是

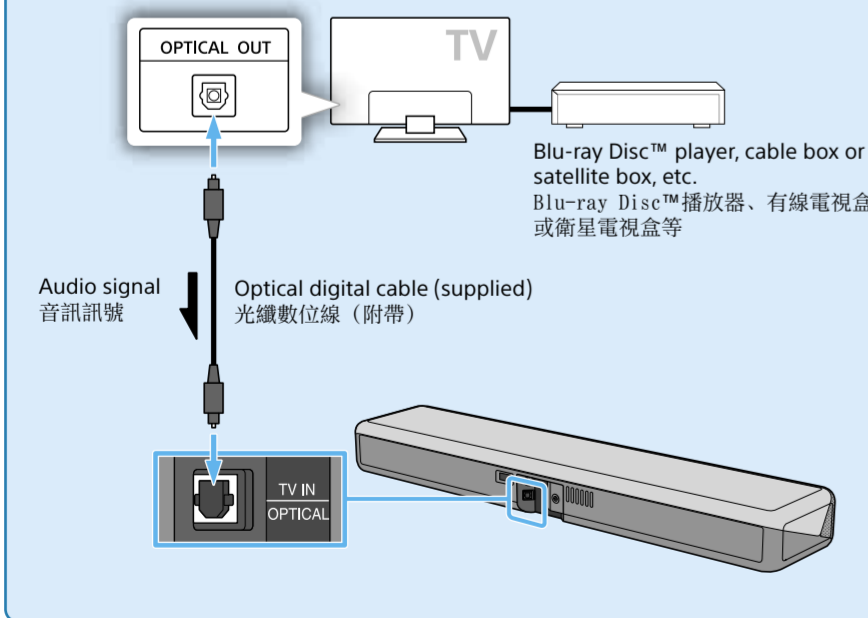

Note

- If the TV's headphone jack also serves as an audio output jack, check the TV's audio output settings. For details, refer to the TV's operating instructions.
- Make sure that the cables are firmly inserted.

NO/否

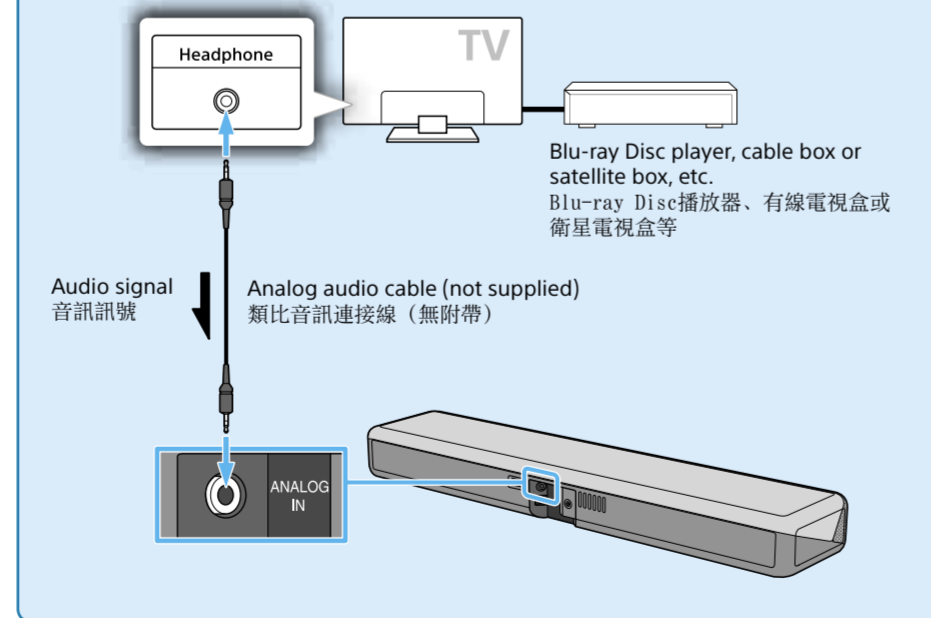

備註

- 如果電視機的耳機插孔也用作音訊輸出插孔，請檢查電視機的音訊輸出設定。如需詳細資訊，請參閱電視機的使用說明書。
- 確定連接線牢固地插入。

2 Turning on the system
開啟系統的電源

1

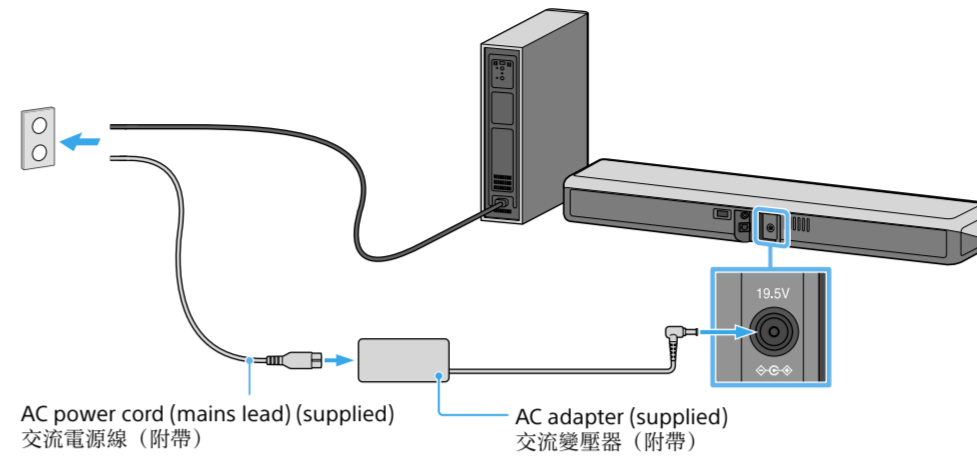

- 1 Connect the AC adapter and AC power cord (mains lead), then connect the AC adapter to the Bar Speaker. Connect the AC power cords (mains leads) of the Bar Speaker and subwoofer to the AC outlets (mains).
- 2 Press Power (power) on the remote control of the system. An input indicator lights up.
- 3 Confirm that the power indicator of the subwoofer is lit in green. If not, refer to "Subwoofer" or "Troubleshooting" in the Operating Instructions (separate document).

Note

- Do not place magnetic cards on the system or near the system.
- Do not place metal objects other than a TV around the system. Wireless functions may become unstable.

To install the subwoofer under a sofa
將主動式重低音揚聲器安裝在沙發下

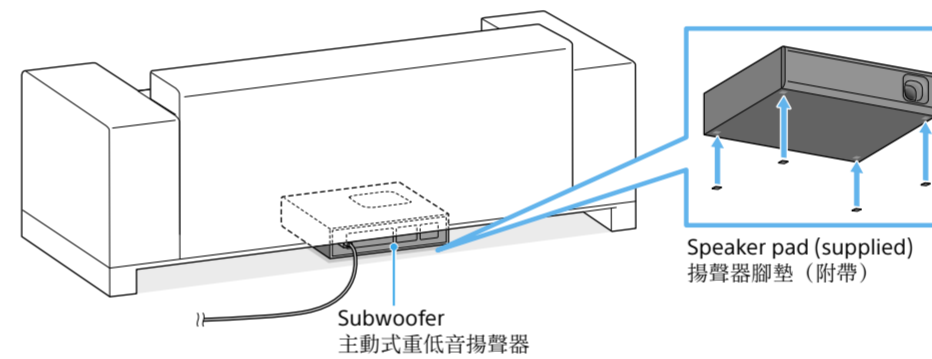

- 1 Put the speaker pads on the subwoofer, then place the subwoofer under a sofa with the speaker facing upward.
- 2 Hold down VOICE on the remote control of the system for 5 seconds. The USB and ANALOG indicators flash twice, then the sofa mode is activated. The sound quality is changed to suit when the subwoofer is installed under a sofa.

- 1 將揚聲器腳墊貼在主動式重低音揚聲器上，然後將主動式重低音揚聲器面向上放在沙發下。
- 2 按住系統遙控器上的VOICE 5秒鐘。USB和ANALOG指示燈閃爍兩次，然後沙發模式啟動。音質改變，以適合安裝在沙發下的主動式重低音揚聲器。

3 Listening to the sound
聆聽聲音

1

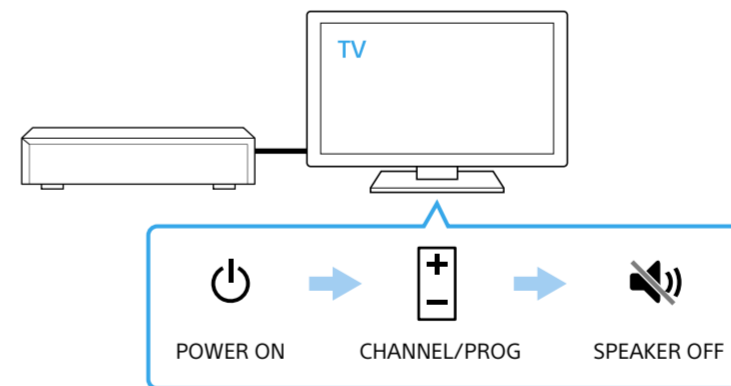

- 1 Turn on the TV, then select the desired program by operating the TV. When sound comes from the TV speakers, try one of the following to silence the TV speakers. For details, refer to the TV's operating instructions.
 - Change the TV setting to output the sound from external speakers.
 - Turn the TV volume down as minimal as possible.
- 2 Press TV on the remote control of the system to turn on the TV indicator. If you connected your TV to the ANALOG jack in step 1, press ANALOG on the remote control of the system.
- 3 Adjust the volume. Adjust the volume by pressing +/- on the remote control of the system. Adjust the volume of the subwoofer by pressing SW +/- on the remote control of the system.

2/3

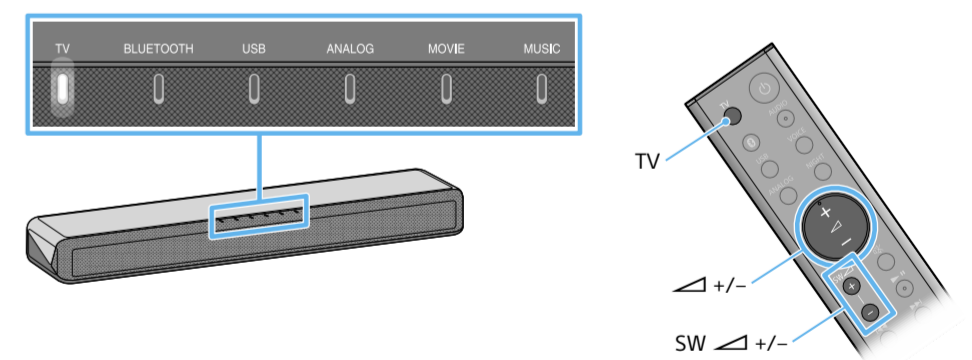

- 1 打開電視機，然後透過操作電視機來選擇所需節目。當聲音來自電視機揚聲器時，嘗試以下方法之一讓電視機揚聲器靜音。如需詳細資訊，請參閱電視機的使用說明書。
 - 更改電視機設定，讓聲音從外部揚聲器輸出。
 - 將電視音量盡可能調到最小。
- 2 按下系統遙控器上的TV以點亮TV指示燈。如果在步驟1中將電視機連接至ANALOG插孔，請按下系統遙控器上的ANALOG。
- 3 調整音量。按下系統遙控器上的 +/- ，以調整音量。按下系統遙控器上的SW +/- ，以調整主動式重低音揚聲器的音量。