

感谢阁下选用Sony IC录音机！

您可使用快速入门指南获取有关IC录音机的基本操作说明。请仔细阅读本指南。希望新的Sony IC录音机能为阁下带来快乐。

使用产品前请仔细阅读本使用说明书，并请妥善保管。

检查附件。

- IC录音机 (1)
- 立体声耳机 (1)
- 便携袋 (1)
- LR03 (AAA尺寸) 碱性电池(2)
- 快速入门指南
- 帮助指南 (存储在内置存储器中的HTML文件, 您可方便地将其复制到您的电脑。)

选购附件

- USB AC适配器AC-UD10

注意

取决于国家或地区, 可能没有某些机型或选项。

部件和控制按钮

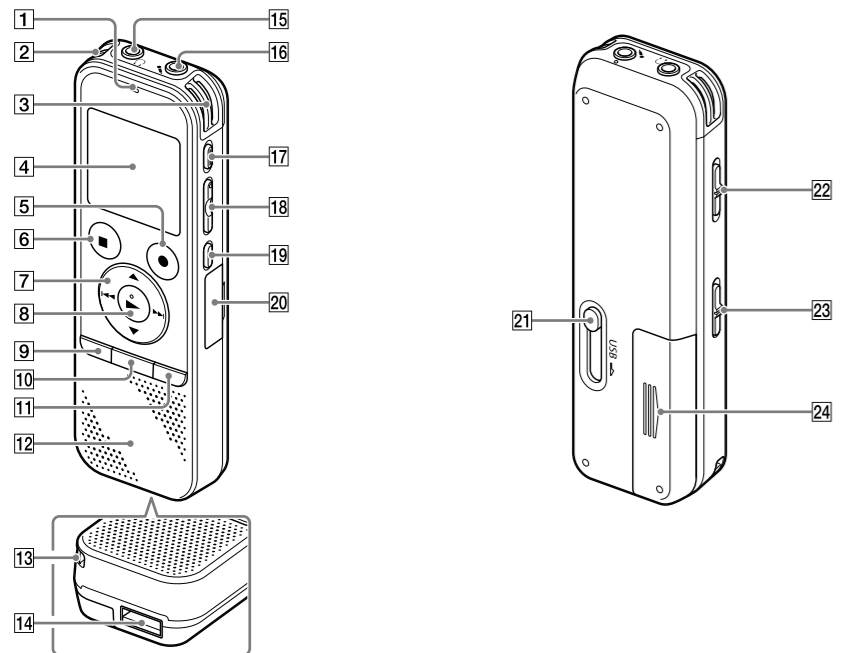

- | | |
|-----------------------------------|-------------------------------|
| 1 操作指示灯 | 18 VOL +/- (音量 +/-) 按钮*1 |
| 2 内置话筒 (立体声) (左) | 19 A-B (重复A-B) 按钮 |
| 3 内置话筒 (立体声) (右) | 20 M2™/microSD存储卡槽 (卡槽在盖中。)*2 |
| 4 显示窗口 | 21 USB滑杆 |
| 5 ●REC/PAUSE (录音/暂停) 按钮 | 22 HOLD•POWER ON/OFF开关 |
| 6 ■STOP按钮 | 23 DPC (SPEED CTRL) 开关 |
| 7 控制按钮 (▲、▼、◀、▶) (回放/快退), (提示/快进) | 24 电池仓 |
| 8 ► (播放/输入) 按钮*1 | |
| 9 MENU按钮 | |
| 10 T-MARK (曲目标记) 按钮 | |
| 11 FOLDER按钮 | |
| 12 扬声器 | |
| 13 腕带安装孔 (不附带腕带。) | |
| 14 USB接口舱 | |
| 15 ◯ (耳机) 插孔 | |
| 16 (话筒) (PLUG IN POWER) 插孔*1 | |
| 17 ERASE按钮 | |

*1 这些按钮及插孔均设有触点。可将其用作操作的参考点, 或用以识别各个端子。

*2 在此快速入门指南中, M2™和microSD卡统称为“存储卡”。M2™/microSD卡槽称为“存储卡槽”。

让我们来试用您的新IC录音机

1. 打开电源。

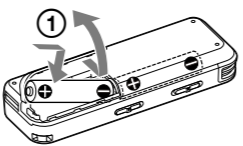

- 1 滑动并提起电池仓盖, 然后按正确极性插入LR03 (AAA尺寸) 碱性电池。
- 2 打开电源。
若要打开电源朝“POWER ON/OFF”方向滑动并按住HOLD•POWER ON/OFF开关, 直到出现窗口显示为止。
若要防止意外操作 (HOLD) 朝“HOLD”方向滑动HOLD•POWER ON/OFF开关。
若要释放IC录音机的HOLD状态, 请朝中心位置滑动HOLD•POWER ON/OFF开关。

2. 设置日期和时间。

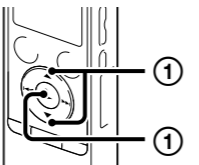

当首次插入电池, 或者当重新插入电池或更换新电池时, 则会出现“请设置日期时间”动画, 年份设置部分随之在时钟设置显示窗口中闪烁。

- 1 按▲或▼设置年份 (年份的最后两位数), 然后按► (播放/输入)。重复该步骤, 依次设置月份、日期、小时和分钟。当您设置分钟并按► (播放/输入) 时, 时钟将反映设置。
您也可以以后再设置时钟设置。有关详情, 请查阅IC录音机的帮助指南。

3. 选择菜单语言。

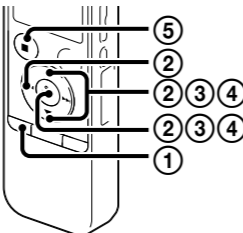

- 1 按MENU。
- 2 按◀◀, 按▲或▼选择, 然后按► (播放/输入)。
- 3 按▲或▼选择“语言 (Language)”, 然后按► (播放/输入)。
- 4 按▲或▼选择要在显示窗口中使用的语言, 然后按► (播放/输入)。可以选择以下语言: 简体中文*、English (英文)* 默认设置
- 5 按■STOP。

4. 录音。

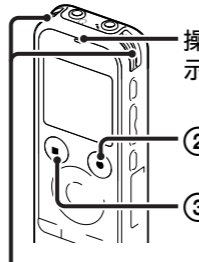

使用IC录音机之前, 务必朝中心位置滑动HOLD•POWER ON/OFF开关以释放HOLD状态。

- 1 放置IC录音机时, 应将内置话筒正对所要录制的声源方向。
- 2 按●REC/PAUSE。录音开始, 操作指示灯呈红色亮起。
可以按●REC/PAUSE暂停录音。再次按●REC/PAUSE可重新开始录音。
- 3 按■STOP停止录音。屏幕将显示“正在访问...”动画, 并且录音停止。

5. 聆听。

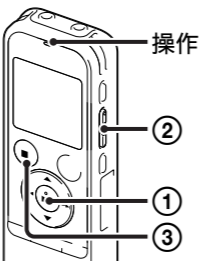

如果没有选择文件, 则将播放刚刚录制的文件或最近播放的文件。有关选择文件的详情, 请查阅IC录音机的帮助指南。

- 1 按► (播放/输入)。播放开始, 操作指示灯呈绿色亮起。
- 2 按VOL +/-调整音量。
- 3 按■STOP停止播放。

6. 删除。

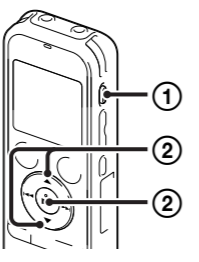

文件一旦删除, 则将无法恢复。

- 1 按ERASE。显示“确定删除?”并且播放所要删除的文件以便确认。
- 2 使用▲或▼选择“执行”, 然后按► (播放/输入)。在删除所选文件的同时, 显示“正在删除...”。

与电脑组合使用

在您的电脑上安装帮助指南

通过从IC录音机的内置存储器安装帮助指南到您的电脑, 在发生问题时您可搜索详细的操作和可能的解决方法。

- 1 滑动IC录音机背面的USB滑杆, 将USB接口插入正在运行的电脑的USB端口。
- 2 在Windows中: 单击[计算机] (或[我的电脑]), 然后双击[IC RECORDER] → [FOR WINDOWS]。
在Mac中: 在桌面上双击[IC RECORDER]。
- 3 安装帮助指南。
在Windows中: 双击 [Help_Guide_Installer] (或 [Help_Guide_Installer.exe])。在Mac中: 双击[Help_Guide_Installer_for_mac.app]。(版本10.5.8或更高版本) 按照屏幕上出现的指示继续安装。
- 4 安装完成之后, 双击Windows桌面上 (Mac在Finder中) 的[Help_Guide_icdp44_cn.htm]图标。
将显示帮助指南。
您也可在以下Sony IC录音机用户支持主页中查阅帮助指南: <http://rd1.sony.net/help/icd/p44/cn/>

将文件从IC录音机复制到电脑

可以将IC录音机的文件和文件夹复制到电脑上进行保存。

- 1 将IC录音机连接到电脑上。
- 2 将要传输的文件或文件夹复制到电脑上。
将要复制的文件或文件夹从“IC RECORDER”或“MEMORY CARD”拖放到电脑的本地磁盘上。

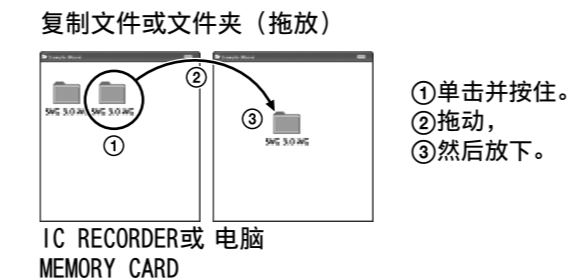

- 3 将IC录音机从电脑上断开。

安装Sound Organizer

在电脑上安装Sound Organizer。

注意

Sound Organizer仅支持Windows电脑。它不支持Mac。

安装Sound Organizer时, 需用具有管理员权限的帐户登录。

- 1 从您的电脑访问以下Sony服务网站: <http://service.sony.com.cn>
- 2 在上面的网站中, 在搜索框中输入“Sound Organizer”查找Sound Organizer下载页面。
- 3 按照下载页面上的指示下载并安装Sound Organizer。

其他功能

录音、播放和编辑等这些附加功能的详情包含在帮助指南中。

- 场景选择
- 录音滤音器
- 消除噪音
- T-MARK (曲目标记)
- DPC (Digital Pitch Control)
- A-B 重复播放
- VOR (Voice Operated Recording)
- 简易搜索
- 分割
- Sound Organizer编辑软件

注意事项

电源
请使用3.0 V或2.4 V操作IC录音机。请使用两节LR03 (AAA尺寸) 碱性电池或NH-AAA可充电电池。

安全
驾车、骑车或操作任何机动车时请勿操作IC录音机。

制造商: 索尼 (中国) 有限公司
地址: 北京市朝阳区
太阳宫中路12号楼
冠城大厦701
产地: 广东省东莞市
产品标准: Q/CYSNC0007
出版日期: 2016年2月

警告
请勿将电池 (已安装的电池组或电池) 长时间暴露于例如阳光, 火等极热的地方。

USB AC适配器: AC-UD10

额定电流: 1500 mA

注意
如果使用不正确的电池类型更换电池有爆炸的危险。请按照规定处理使用过的电池。

容量 (用户可用容量)*1*2
4 GB (约3.60 GB=3865470566字节)

*1 少量内置存储器被用于文件管理, 因此不能被用作用户存储。

*2 当用IC录音机格式化内置存储器时。

尺寸 (宽/高/深) (不包括突出部件和控制按钮) (JEITA) *3
约37.2 mm × 113.2 mm × 19.3 mm

重量 (JEITA) *3
约75 g, 包括两节LR03 (AAA尺寸) 碱性电池。

*3按JEITA (Japan Electronics and Information Technology Industries Association) 标准的测量值

产品中有害物质的名称及含量

部件名称	有害物质					
	铅 (Pb)	汞 (Hg)	镉 (Cd)	六价铬 (Cr (VI))	多溴联苯 (PBB)	多溴二苯醚 (PBDE)
内置线路板	×	○	○	○	○	○
外壳	×	○	○	○	○	○
显示板	○	○	○	○	○	○
扬声器	×	○	○	○	○	○
附件	○	○	○	○	○	○

本表格依据SJ/T 11364 的规定编制。

○: 表示该有害物质在该部件所有均质材料中的含量均在GB/T 26572规定的限量要求以下。

×: 表示该有害物质至少在该部件的某一均质材料中的含量超出GB/T 26572规定的限量要求。

(○:不含有, ×:含有)



ICD-PX440

Welcome to your new Sony IC recorder!

This is the Quick Start Guide, which provides you with instructions on the basic operations of the IC recorder. Please read it carefully. We hope you enjoy using your new Sony IC recorder.

Check the supplied items.

- IC Recorder (1)
- Stereo headphones (1)
- Carrying pouch (1)
- LR03 (size AAA) alkaline battery (2)
- Quick Start Guide
- Help Guide (HTML file stored in the built-in memory so it can easily be copied to your computer.)

Optional accessories

- USB AC adaptor AC-UD10

Note
Depending on the country or region, some of the models or optional accessories are not available.

Parts and controls

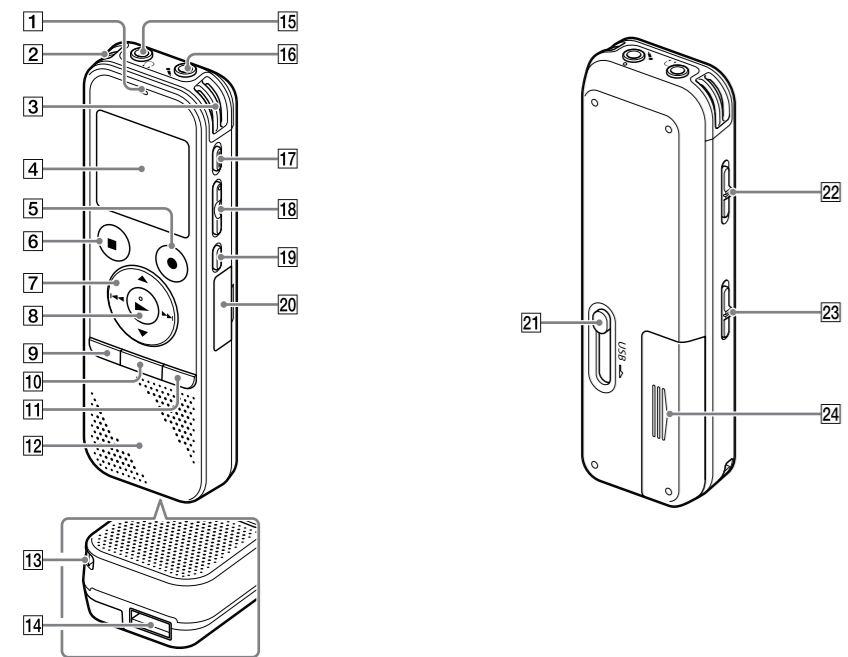

- | | |
|--|--|
| 1 Operation indicator | 18 VOL +/- (volume +/-) button* |
| 2 Built-in microphones (stereo) (L) | 19 A-B (repeat A-B) button |
| 3 Built-in microphones (stereo) (R) | 20 M2/microSD memory card slot (The card slot is in the cover.) ² |
| 4 Display window | 21 USB slide lever |
| 5 ●REC/PAUSE (record/pause) button | 22 HOLD+POWER ON/OFF switch |
| 6 ■STOP button | 23 DPC (SPEED CTRL) switch |
| 7 Control button (▲, ▼, I◀◀ (review/fast backward), ▶▶ (cue/fast forward)) | 24 Battery compartment |
| 8 ►(play/enter) button* | |
| 9 MENU button | |
| 10 T-MARK (track mark) button | |
| 11 FOLDER button | |
| 12 Speaker | |
| 13 Strap hole (A strap is not supplied.) | |
| 14 USB connector compartment | |
| 15 ◯ (headphones) jack | |
| 16 ◯ (microphone) (PLUG IN POWER) jack* | |
| 17 ERASE button | |

*1 These buttons and the jack have a tactile dot. Use it as a reference point for operations, or to identify each terminal.

*2 In this Quick Start Guide, M2_m and microSD cards are generally referred to as a "memory card." The M2_m/microSD card slot is referred to as the "memory card slot."

Let's try out your new IC recorder

1. Power on.

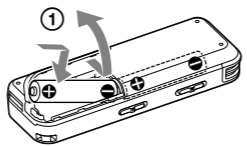

- Slide and lift the battery compartment lid, then insert LR03 (size AAA) alkaline batteries with the correct polarity.

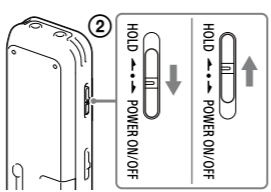

- Turn the power on.
To turn the power on
Slide and hold the HOLD+POWER ON/OFF switch in the direction of "POWER ON/OFF" until the window display appears.
To prevent unintentional operations (HOLD)
Slide the HOLD+POWER ON/OFF switch in the direction of "HOLD."
⚡ To release the IC recorder from the HOLD status, slide the HOLD+POWER ON/OFF switch towards the center.

2. Set the date and time.

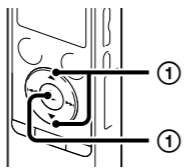

When you insert batteries for the first time, or when you re-insert batteries or replace batteries with new ones, the "请设置日期时间" animation appears, and then the year section begins to flash in the clock setting display window.

- Press ▲ or ▼ to set the year (the last two digits of the year), and then press ►(play/enter). Repeat this procedure to set month, day, hour, and minute in sequence.
When you set the minute and press ►(play/enter), the clock reflects the setting.
⚡ You can set the clock setting later. For details, refer to the Help Guide of the IC recorder.



3. Select the menu language.

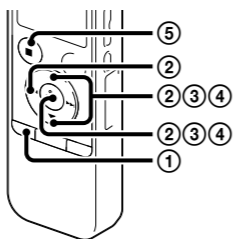

- Press MENU.
- Press ◀◀, press ▲ or ▼ to select 语言(Language), and then press ►(play/enter).
- Press ▲ or ▼ to select "语言(Language)," and then press ►(play/enter).
- Press ▲ or ▼ to select the language that you want to use in the display window, and then press ►(play/enter).
You can select the following languages:
简体中文* (Chinese), English
* Default setting
- Press ■STOP.



4. Record.

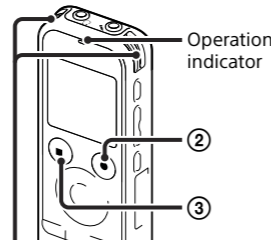

⚡ Before you start using the IC recorder, make sure that you slide the HOLD+POWER ON/OFF switch towards the center to release the HOLD status.
1 Place the IC recorder so that the built-in microphones face the direction of the source to be recorded.

- Press ●REC/PAUSE.
Recording starts and the operation indicator lights in red.
⚡ You can pause recording by pressing ●REC/PAUSE. Press ●REC/PAUSE again to restart recording.
- Press ■STOP to stop recording.
The "正在访问..." animation appears and the recording stops.

5. Listen.

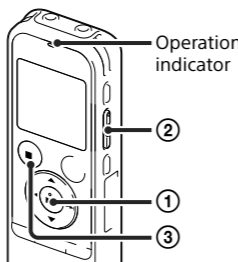

⚡ If you do not select a file, the file just recorded or played back most recently will be played back.
For details of selecting a file, refer to the Help Guide of the IC recorder.

- Press ►(play/enter).
Playback starts and the operation indicator lights in green.
- Adjust the volume by pressing VOL +/-.
- Press ■STOP to stop playback.

6. Erase.

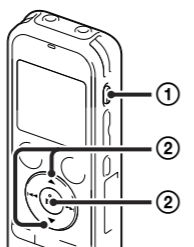

⚡ Once a file is erased, you cannot restore it.

- Press ERASE.
"确定删除?" is displayed and the file to be erased is played back for confirmation.
- Select "执行" using ▲ or ▼, and then press ►(play/enter).
"正在删除..." is displayed while the selected file is being erased.

Utilizing Your Computer

Installing the help guide on your computer

By installing the help guide on your computer from the built-in memory of the IC recorder, you can search for detailed operations and possible solutions when a problem occurs.

- Slide the USB slide lever on the back of the IC recorder, and insert the USB connector into the USB port of a running computer.
- In Windows: Click [Computer] (or [My Computer]), then double-click [IC RECORDER] → [FOR WINDOWS].
In Mac: Double-click [IC RECORDER] on the desktop.
- Install the help guide.
In Windows: Double-click [Help_Guide_Installer] (or [Help_Guide_Installer.exe]).
In Mac: Double-click [Help_Guide_Installer_for_mac.app]. (v10.5.8 or higher)
Follow the instructions that appear on the screen to proceed with installation.
- After the installation completes, double-click the [Help_Guide_icdp44_cn.htm] icon in the desktop for Windows (or in Finder for Mac).
The help guide is displayed.
You can also view the help guide on the following Sony IC Recorder customer support home page:
<http://rd1.sony.net/help/icd/p44/cn/>

Copying files from the IC recorder to your computer

You can copy the files and folders from the IC recorder to your computer to store them.

- Connect the IC recorder to your computer.
- Copy files or folders you want to transfer to your computer.
Drag and drop the files or folders you want to copy from "IC RECORDER" or "MEMORY CARD" to the local disk on your computer.

To copy a file or folder (Drag and drop)

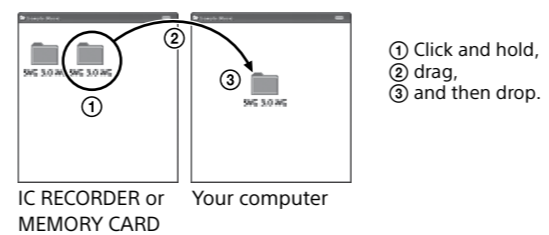

- Disconnect the IC recorder from your computer.

Installing Sound Organizer

Install Sound Organizer on your computer.

Note
Sound Organizer is compatible with the Windows PC only. It is not compatible with Mac.

⚡ When installing Sound Organizer, log in to an account with administrator privileges.

- Access the following Sony Service web site from your computer:
<http://service.sony.com.cn>
- On the above web site, enter "Sound Organizer" in the search box to locate the Sound Organizer download page.
- Follow the procedures instructed on the download page to download and then install the Sound Organizer.

Additional features

Details of these additional features for recording, playback, and editing are included in the help guide.

- Scene Selection
- 录音滤波器(Recording Filter)
- 消除噪音(Noise Cut)
- T-MARK (Track mark)
- DPC (Digital Pitch Control)
- A-B Repeat
- VOR (Voice Operated Recording)
- 简易搜索(Easy Search)
- Divide
- Sound Organizer editing software

Precautions

On power

Operate the IC recorder on 3.0 V or 2.4 V.
Use two LR03 (size AAA) alkaline batteries or NH-AAA rechargeable batteries.

On safety

Do not operate the IC recorder while driving, cycling or operating any motorized vehicle.

On handling

- Do not leave the IC recorder in a location near heat sources, or in a place subject to direct sunlight, excessive dust or mechanical shock.
- Should any solid object or liquid fall into the IC recorder, remove the battery and have the IC recorder checked by qualified personnel before operating it any further.
If you have any questions or problems concerning your IC recorder, please consult your nearest Sony dealer.

WARNING

Do not expose the batteries (battery pack or batteries installed) to excessive heat such as sunshine, fire or the like for a long time.

CAUTION

Risk of explosion if battery is replaced by an incorrect type.
Dispose of used batteries according to the instructions.

Capacity (User available capacity)^{*1*}

4 GB (approx. 3.60 GB = 3,865,470,566 Byte)

*1 A small amount of the built-in memory is used for file management and therefore not available for user storage.
*2 When the built-in memory is formatted with the IC recorder.

Dimensions (w/h/d) (not incl. projecting parts and controls) (JEITA)^{*3}

Approx. 37.2 mm × 113.2 mm × 19.3 mm

Mass (JEITA)^{*3}

Approx. 75 g including two LR03 (size AAA) alkaline batteries

*3 Measured value by the standard of JEITA (Japan Electronics and Information Technology Industries Association)

For the customers in China

RATED CURRENT CONSUMPTION: 1500 mA

USB AC adaptor: AC-UD10