

Home Audio System

Operating Instructions

Getting Started

Disc

Tuner

iPod/iPhone

USB Device

Other Operations

Additional Information

WARNING

To reduce the risk of fire or electric shock, do not expose this apparatus to rain or moisture.

To reduce the risk of fire, do not cover the ventilation opening of the appliance with newspapers, tablecloths, curtains, etc. Do not expose the appliance to naked flame sources (for example, lighted candles).

To reduce the risk of fire or electric shock, do not expose this appliance to dripping or splashing, and do not place objects filled with liquids, such as vases, on the appliance.

Do not install the appliance in a confined space, such as a bookcase or built-in cabinet.

As the main plug is used to disconnect the unit from the mains, connect the unit to an easily accessible AC outlet. Should you notice an abnormality in the unit, disconnect the main plug from the AC outlet immediately.

Do not expose batteries or appliances with battery-installed to excessive heat, such as sunshine and fire.

The unit is not disconnected from the mains as long as it is connected to the AC outlet, even if the unit itself has been turned off.

CAUTION

The use of optical instruments with this product will increase eye hazard.

Except for customers in the USA and Canada

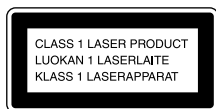

This appliance is classified as a CLASS 1 LASER product. This marking is located on the rear exterior.

Notice for the customers in the USA

Owner's Record

The model and serial numbers are located on the rear of the unit. Record these numbers in the space provided below. Refer to them whenever you call upon your Sony dealer regarding this product.

Model No. _____

Serial No. _____

Important Safety Instructions

- 1) Read these instructions.
- 2) Keep these instructions.
- 3) Heed all warnings.
- 4) Follow all instructions.
- 5) Do not use this apparatus near water.
- 6) Clean only with dry cloth.
- 7) Do not block any ventilation openings. Install in accordance with the manufacturer's instructions.
- 8) Do not install near any heat sources such as radiators, heat registers, stoves, or other apparatus (including amplifiers) that produce heat.
- 9) Do not defeat the safety purpose of the polarized or grounding-type plug. A polarized plug has two blades with one wider than the other. A grounding type plug has two blades and a third grounding prong. The wide blade or the third prong are provided for your safety. If the provided plug does not fit into your outlet, consult an electrician for replacement of the obsolete outlet.
- 10) Protect the power cord from being walked on or pinched particularly at plugs, convenience receptacles, and the point where they exit from the apparatus.
- 11) Only use attachments/accessories specified by the manufacturer.
- 12) Use only with the cart, stand, tripod, bracket, or table specified by the manufacturer, or sold with the apparatus. When a cart is used, use caution when moving the cart/apparatus combination to avoid injury from tip-over.



- 13) Unplug this apparatus during lightning storms or when unused for long periods of time.
- 14) Refer all servicing to qualified service personnel. Servicing is required when the apparatus has been damaged in any way, such as power-supply cord or plug is damaged, liquid has been spilled or objects have fallen into the apparatus, the apparatus has been exposed to rain or moisture, does not operate normally, or has been dropped.

The following FCC statement applies only to the version of this model manufactured for sale in the USA. Other versions may not comply with FCC technical regulations.

NOTE:

This equipment has been tested and found to comply with the limits for a Class B digital device, pursuant to Part 15 of the FCC Rules. These limits are designed to provide reasonable protection against harmful interference in a residential installation. This equipment generates, uses, and can radiate radio frequency energy and, if not installed and used in accordance with the instructions, may cause harmful interference to radio communications. However, there is no guarantee that interference will not occur in a particular installation. If this equipment does cause harmful interference to radio or television reception, which can be determined by turning the equipment off and on, the user is encouraged to try to correct the interference by one or more of the following measures:

- Reorient or relocate the receiving antenna.
- Increase the separation between the equipment and receiver.
- Connect the equipment into an outlet on a circuit different from that to which the receiver is connected.
- Consult the dealer or an experienced radio/TV technician for help.

CAUTION

You are cautioned that any changes or modifications not expressly approved in this manual could void your authority to operate this equipment.

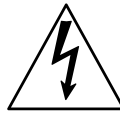

This symbol is intended to alert the user to the presence of uninsulated “dangerous voltage” within the product’s enclosure that may be of sufficient magnitude to constitute a risk of electric shock to persons.



This symbol is intended to alert the user to the presence of important operating and maintenance (servicing) instructions in the literature accompanying the appliance.

Notice for customers: the following information is only applicable to equipment sold in countries applying EU directives.

This product has been manufactured by or on behalf of Sony Corporation, 1-7-1 Konan Minato-ku Tokyo, 108-0075 Japan. Inquiries related to product compliance based on European Union legislation shall be addressed to the authorized representative, Sony Deutschland GmbH, Hedelfinger Strasse 61, 70327 Stuttgart, Germany. For any service or guarantee matters, please refer to the addresses provided in the separate service or guarantee documents.

For customers in Europe and Australia



Disposal of Old Electrical & Electronic Equipment (Applicable in the European Union and other European countries with separate collection systems)

This symbol on the product or on its packaging indicates that this product shall not be treated as household waste. Instead it shall be handed over to the applicable collection point for the recycling of electrical and electronic equipment. By ensuring this product is disposed of correctly, you will help prevent potential negative consequences for the environment and human health, which could otherwise be caused by inappropriate waste handling of this product. The recycling of materials will help to conserve natural resources. For more detailed information about recycling of this product, please contact your local Civic Office, your household waste disposal service or the shop where you purchased the product. Applicable accessories: Remote commander

Europe Only



Pb

Disposal of waste batteries (applicable in the European Union and other European countries with separate collection systems)

This symbol on the battery or on the packaging indicates that the battery provided with this product shall not be treated as household waste. On certain batteries this symbol might be used in combination with a chemical symbol. The chemical symbols for mercury (Hg) or lead (Pb) are added if the battery contains more than 0.0005% mercury or 0.004% lead. By ensuring these batteries are disposed of correctly, you will help prevent potentially negative consequences for the environment and human health which could otherwise be caused by inappropriate waste handling of the battery. The recycling of the materials will

help to conserve natural resources. In case of products that for safety, performance or data integrity reasons require a permanent connection with an incorporated battery, this battery should be replaced by qualified service staff only. To ensure that the battery will be treated properly, hand over the product at end-of-life to the applicable collection point for the recycling of electrical and electronic equipment.

For all other batteries, please view the section on how to remove the battery from the product safely. Hand the battery over to the applicable collection point for the recycling of waste batteries.

For more detailed information about recycling of this product or battery, please contact your local Civic Office, your household waste disposal service or the shop where you purchased the product.

Note on DualDiscs

A DualDisc is a two sided disc product which mates DVD recorded material on one side with digital audio material on the other side. However, since the audio material side does not conform to the Compact Disc (CD) standard, playback on this product is not guaranteed.

Music discs encoded with copyright protection technologies

This product is designed to playback discs that conform to the Compact Disc (CD) standard. Recently, various music discs encoded with copyright protection technologies are marketed by some record companies. Please be aware that among those discs, there are some that do not conform to the CD standard and may not be playable by this product.

Table of Contents

Guide to parts and controls 6

Getting Started

Hooking up the system
securely..... 9
Inserting batteries 10
Setting the clock..... 10

Disc

Playing a CD/MP3 disc 11

Tuner

Listening to the radio13

iPod/iPhone

Playing the iPod/iPhone 14

USB Device

Before using the USB device ... 16
Transferring music from
a disc.....17
Playing a file 18

Other Operations

Adjusting the sound.....21
Changing the display21
Using the timers 22

Additional Information

Compatible devices with this
system..... 23
Troubleshooting 23
Messages..... 27
Precautions 28
Specifications..... 29
License and Trademark
Notice.....31

Guide to parts and controls

This manual mainly explains operations using the remote control, but the same operations can also be performed using the buttons on the unit having the same or similar names.

Unit

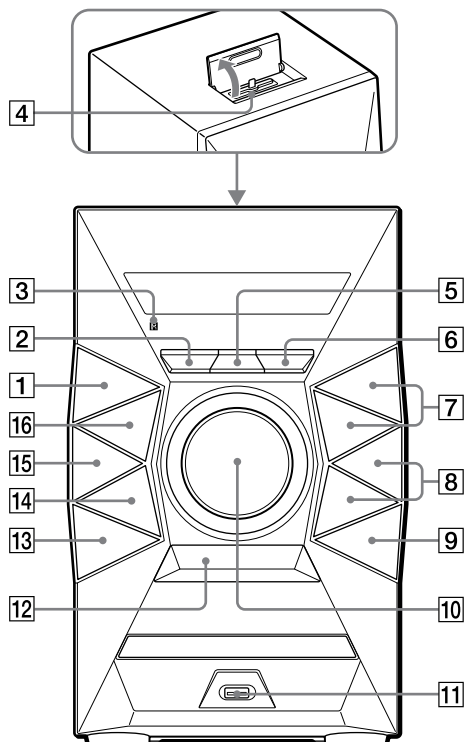

About the child lock function

You can lock the buttons except I/⏻ (on/standby) on the unit to prevent them from being operated by mistake. Hold down ■ (stop) on the unit until "LOCK ON" or "LOCK OFF" appears on the display. The buttons except I/⏻ on the unit will be locked or unlocked.

Remote control

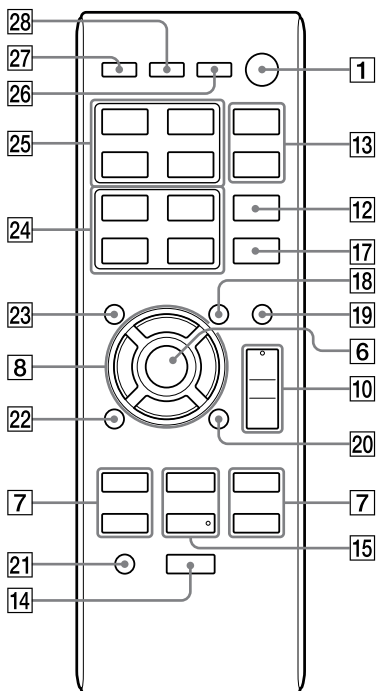

1
I/⏻ (on/standby) button
Press to turn on or off the system.

2
OPTIONS button (page 19)
Press to enter or exit the option menus.

3
Remote control sensor

4
Lightning connector
Connect iPhone 5, iPod touch (5th generation) or iPod nano (7th generation).

5
REC TO USB button (page 17)
Press to transfer music from a disc to the connected optional USB device.

6
Unit: ENTER button
Remote control: ⏻ button
Press to enter/confirm the settings.

7
TUNING+/TUNING– button
Press to tune to the desired station.

◀◀ (go backward)/▶▶ (go forward) button
Press to select a track or file.

◀◀ (rewind)/▶▶ (fast forward) button
Press to find a point in a track or file.

Remote control: PRESET+/PRESET– button
Press to select a preset radio station.

8
📁 +/📁 – (select folder) button (page 11, 18)
Press to select a folder.

Unit: PRESET+/PRESET– button
Press to select a preset radio station.

Remote control: ⬆/⬇/⬅/➡ button
Press to operate the menu of iPod/iPhone.

9
⏏ OPEN/CLOSE button
Press to open or close the disc tray.

10
Unit: VOLUME control
Turn to adjust the volume.

Remote control: VOLUME +*/– button
Press to adjust the volume.

11
🔌 (USB) port
Connect an optional USB device.

12
BASS BOOST button (page 21)
Press to create a more dynamic sound.

13

Unit: EQ button

Remote control: EQ +/-EQ – button (page 21)

Press to select the preset sound effect.

14

■ (stop) button

Press to stop playback.

15

Unit: ►|| (play/pause) button

Press to start or pause playback.

Remote control: ► (play)* button

Press to start playback.

Remote control: || (pause) button

Press to pause playback.

16

FUNCTION button

Press to select the function.

17

REPEAT button (page 11, 18)

Press to activate repeat playback mode.

18

TUNING MODE button (page 13)

Press to select the tuning mode.

19

PLAY MODE button (page 11, 18)

Press to select the play mode of a CD, MP3 disc or USB device.

20

FM MODE button (page 13)

Press to select the FM reception mode (monaural or stereo).

21

CLEAR button (page 20)

Press to delete the last step from the program list.

22

RETURN button (page 14)

Press to return to the previous menu on the iPod/iPhone.

23

TUNER MEMORY button (page 13)

Press to preset the radio station.

24

TUNER MEMORY NUMBER button (page 13)

Press to tune to a preset radio station.

25

CD button

Press to select the CD function.

USB button

Press to select the USB function.

FM button

Press to select the FM function.

iPod button

Press to select the iPod function.

26

DISPLAY button (page 21)

Press to change the information on the display.

27

SLEEP button (page 22)

Press to set the Sleep Timer.

28

TIMER MENU button (page 10, 22)

Press to set the clock and the Play Timer.

* The VOLUME + and ► buttons on the remote control have a tactile dot. Use the tactile dot as a reference when operating the system.

Hooking up the system securely

- A To left speaker
- B To right speaker
- C Speaker cord (Red/⊕)
- D Speaker cord (Black/⊖)
- E FM lead antenna (Extend it horizontally.)
- F To wall outlet

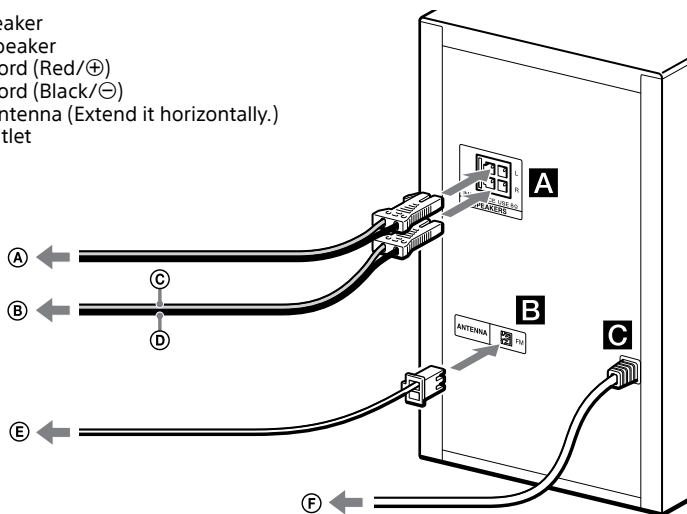

A SPEAKERS

Connect the speaker cords.

B ANTENNA

Find a location and orientation that provide good reception when you set up the antenna.

Keep the antenna away from the speaker cords and the power cord to avoid picking up noise.

C Power

Connect the power cord to a wall outlet.

Attaching the speaker pads

Attach the supplied speaker pads at each corner on the bottom of the speakers to prevent them from slipping.

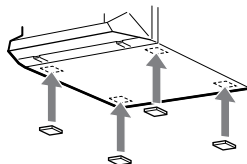

When carrying this system

Make sure that there is no disc loaded and no USB device or no iPod/iPhone is connected, and remove the power cord from the wall outlet.

Inserting batteries

Insert an R6 (size AA) battery (supplied), matching the polarity shown below.

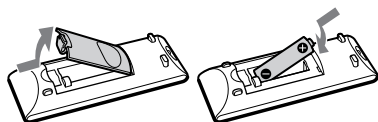

Notes on using the remote control

- With normal use, the battery should last for about six months.
- If you do not use the remote control for a long period of time, remove the battery to avoid damage from battery leakage and corrosion.

Setting the clock

- 1 Press I/⏻ to turn on the system.**
- 2 Press TIMER MENU to select the clock set mode.**
If "SELECT" appears, press ◀◀/▶▶ repeatedly to select "CLOCK," and then press ⊕ (ENTER).
- 3 Press ▲/▼ repeatedly to set the hour, then press ⊕.**
- 4 Use the same procedure to set the minutes.**

Note

The clock settings are lost when you disconnect the power cord or if a power failure occurs.

To display the clock when the system off

Press DISPLAY. The clock is displayed for a few seconds.

Playing a CD/MP3 disc

1 Select the CD function.

Press CD.

2 Place a disc.

Press \blacktriangle OPEN/CLOSE on the unit to open the disc tray, then place a disc with the label side up in the disc tray.

3 Press \blacktriangle OPEN/CLOSE on the unit to close the disc tray.

Playback starts automatically when you close the disc tray. If playback does not start automatically, press \blacktriangleright (play).

Other operations

To	Press
Pause playback	\parallel . To resume play, press \blacktriangleright .
Stop playback	\blacksquare . To resume play, press \blacktriangleright . To cancel resume play, press \blacksquare again.
Select a folder on an MP3 disc	$\text{Folder} + / \text{Folder} -$ repeatedly.
Select a track or file	$\blacktriangleleft\blacktriangleleft / \blacktriangleright\blacktriangleright$.
Find a point in a track or file	Hold down $\blacktriangleleft\blacktriangleleft / \blacktriangleright\blacktriangleright$ during playback, and release the button at the desired point.
Select Repeat Play	REPEAT repeatedly until "REP ONE" ^{*1} , "REP FLDR" ^{*2} or "REP ALL" ^{*3} appears.
Change the play mode	PLAY MODE repeatedly while the player is stopped. You can select normal play ("FLDR" for all MP3 files in the folder on the disc), shuffle play ("SHUF" or "FLDRSHUF" for folder shuffle), or program play ("PROGRAM").

*1 "REP ONE": Repeats the current track or file.

*2 "REP FLDR" (MP3 disc only): Repeats the current folder.

*3 "REP ALL": Repeats all tracks or files.

Notes on playing MP3 discs

- Do not save other types of files or unnecessary folders on a disc that has MP3 files.
- Folders that have no MP3 files are skipped.
- MP3 files are played back in the order that they are recorded onto the disc.
- The system can only play MP3 files that have a file extension of ".mp3."
- Even when file name has the correct file extension, if the actual file differs, playing this file may generate a loud noise by which the system may malfunction.
- The maximum number of:
 - folders is 256 (including the root folder).
 - MP3 files is 999.
 - folder levels (the tree structure of files) is 8.
- Compatibility with all MP3 encoding/writing software, recording device, and recording media cannot be guaranteed. Incompatible MP3 discs may produce noise or interrupted audio or may not play at all.

Note on playing multisession discs

The system can play back continuous sessions on a disc when they are recorded in the same session format as the first session. When a session recorded in a different session format is encountered, that session and the ones following it cannot be played back. Note that even if the sessions are recorded in the same format, some sessions may not play back.

Creating your own program (Program Play)

- 1 Select the CD function.**
Press CD.
- 2 Select the play mode.**
Press PLAY MODE repeatedly until "PROGRAM" appears while the player is stopped.
- 3 Select the desired track or file number.**
Press ◀◀/▶▶ repeatedly until the desired track or file number appears.

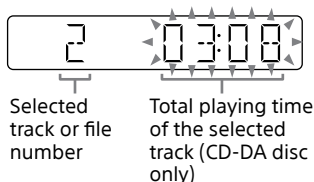

When programming MP3 files in a specific folder, press +/ — repeatedly to select the desired folder, and then select the desired file.

- 4 Program the selected track or file.**
Press ⊕ to enter the selected track or file.
- 5 Repeat steps 3 through 4 to program additional tracks or files, up to a total of 64 tracks or files.**
- 6 To play your program of tracks or files, press ▶.**
The program is cleared when you perform one of the following operations:
 - changing the function.
 - turning off the system.
 - disconnecting the power cord.
 - opening the disc tray.To play the same program again, press ▶.

To cancel Program Play

Press PLAY MODE.

To delete the last step from the program list

Press CLEAR when playback is stopped.

Listening to the radio

1 Select the FM function.

Press FM.

2 Perform tuning.

For automatic scanning

Press TUNING MODE repeatedly until "AUTO" appears, and then press TUNING+/TUNING-. Scanning stops automatically when a station is found.

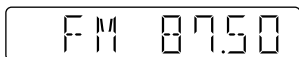

If the scanning does not stop, press ■ to stop scanning, then perform manual tuning (below).

For manual tuning

Press TUNING MODE repeatedly until "MANUAL" appears, and then press TUNING+/TUNING- repeatedly to tune to the desired station.

When you tune to a station that provides RDS services, the station name appears on the display (European model only).

Tip

To reduce static noise on a weak FM stereo station, press FM MODE repeatedly until "MONO" appears to turn off stereo reception. You will lose stereo effect, but reception will improve.

Presetting radio stations

1 Tune to the desired station.

2 Press TUNER MEMORY to select the tuner memory mode.

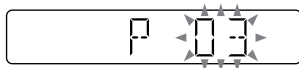

3 Press PRESET+/PRESET- repeatedly to select the desired preset number.

If another station is already assigned to the selected preset number, the station is replaced by the new station.

4 Press ⊕ to store the station.

5 Repeat steps 1 through 4 to store other stations.

You can preset up to 20 FM stations. The preset stations are retained for about half a day even if you disconnect the power cord or if a power failure occurs.

To tune to a preset radio station

If you registered a radio station to a preset number 1 to 4, the radio station will be tuned in by just pressing the TUNER MEMORY NUMBER (1 to 4) when the system function is set to FM. If you registered a radio station to a preset number 5 or higher, press TUNING MODE repeatedly until "PRESET" appears then press PRESET+/PRESET- repeatedly to select the desired preset number.

Playing the iPod/iPhone

The Lightning connector works with iPhone 5, iPod touch (5th generation) and iPod nano (7th generation). USB works with iPhone 5, iPhone 4S, iPhone 4, iPhone 3GS, iPod touch (3rd, 4th and 5th generation), iPod classic and iPod nano (4th through 7th generation).

Also refer to page 23.

1 Select the function.

For iPhone 5, iPod touch (5th generation) or iPod nano (7th generation)
Press iPod.

For other iPod/iPhone models
Press USB.

2 Connect the iPod/iPhone.

For iPhone 5, iPod touch (5th generation) or iPod nano (7th generation)
Connect the iPod/iPhone to the Lightning connector.

For other iPod/iPhone models
Connect the iPod/iPhone to the ⏏ (USB) port, using the USB cable supplied with the iPod/iPhone.

3 Start playback.

Press ▶.

Other operations

To	Press
Pause playback	⏸/▶.
Stop	■.
Select a track	⏮/▶⏭.
Find a point in a track	Hold down ⏮/▶⏭ during playback, and release the button at the desired point.
Choose the selected item	⊕/➤. You can choose the selected item much like the center button operation or the touch operation of the iPod/iPhone.
Scroll up/down the menus	⬆/⬇. You can scroll up or down the menus much like the "Click Wheel" operations or the drag up-or-down operations of the iPod/iPhone.
Return to the previous menu*	⏪/RETURN.

* This operation may be invalid in some applications.

Notes

- The performance of the system may vary, depending on the specifications of your iPod/iPhone.
Operate the iPod/iPhone directly if you cannot operate the iPod/iPhone normally using the system.
- When connecting or disconnecting the iPod/iPhone, brace the system with one hand and take care not to press the controls of the iPod/iPhone by mistake.
- Before disconnecting the iPod/iPhone, pause playback.
- To change the volume level, use VOLUME +/- . The volume level does not change even if you adjust it on the iPod/iPhone.
- Sony cannot accept responsibility in the event that data recorded to iPod/iPhone is lost or damaged when using an iPod/iPhone with this system.

To use the system as a battery charger

You can use the system as a battery charger for an iPod/iPhone when the system is on.

1 Select the function.

For iPhone 5, iPod touch (5th generation) or iPod nano (7th generation)

Press iPod.

For other iPod/iPhone models

Press USB.

2 Connect the iPod/iPhone.

For iPhone 5, iPod touch (5th generation) or iPod nano (7th generation)

Connect the iPod/iPhone to the Lightning connector.

For other iPod/iPhone models

Connect the iPod/iPhone to the ⏏ (USB) port, using the USB cable supplied with the iPod/iPhone.

The charging begins when iPod/iPhone is connected to the Lightning connector or the ⏏ (USB) port. The charge status appears on the display of iPod/iPhone. For details, see the user's guide of your iPod/iPhone.

To stop charging an iPod/iPhone

Disconnect the iPod/iPhone. Turning off the system also stops charging the iPod/iPhone.

Before using the USB device

Check the information on websites for compatible USB devices using the URLs listed under “USB devices” in “Compatible devices with this system” (page 23). For details on how to use the USB device, refer to the user’s guide supplied with your USB device.

Notes

- When USB cable connection is necessary, connect the USB cable supplied with the USB device to be connected. See the operation manual supplied with the USB device to be connected for details on the operation method.
- It may take a long time before “SEARCH” appears depending on the type of USB device connected.
- Do not connect the system and the USB device through a USB hub.
- When the USB device is inserted, the system reads all the files on the USB device. If there are many folders or files on the USB device, it may take a long time to finish reading the USB device.
- With some connected USB devices, after an operation is performed, there may be a delay before it is performed by this system.
- Compatibility with all encoding/writing software cannot be guaranteed. If audio files on the USB device were originally encoded with incompatible software, those files may produce noise or interrupted audio, or may not play at all.
- This system does not necessarily support all the functions provided in a connected USB device.
- Do not remove the USB device during transferring or erase operations. Doing so may corrupt the data on the device or damage the device itself.

To use the system as a battery charger

You can use the system as a battery charger for USB devices that have a rechargeable function when the system is on.

- 1 Select the USB function.**
Press USB.
- 2 Connect the USB device to the ⚡ (USB) port.**
The charging begins when the USB device is connected to the ⚡ (USB) port. For details, see the user’s guide of your USB device.

Transferring music from a disc

You can transfer music from a disc (CD-DA disc or MP3 disc) by using the following transfer modes of this system.

CD SYNC transfer: Transfer all the CD-DA tracks from the CD-DA disc.

MP3 folder transfer: Transfer MP3 files in a specific folder from the MP3 disc.

REC1 transfer: Transfer a currently playing track or MP3 file from the disc.

1 Select the CD function.

Press CD.

2 Connect the USB device to the Ψ (USB) port.

3 Load a disc you want to transfer.

If playback starts automatically, press \blacksquare twice.

4 Prepare for transferring.

Proceed to step 5 in case of CD SYNC transfer.

For MP3 folder transfer

To transfer MP3 files in a specific folder, press $\text{Folder} + / \text{Folder} -$ repeatedly to select the folder you want. Then start playback and press \blacksquare once.

Make sure the elapsed playing time has stopped on the display.

For REC1 transfer

Press $\text{Left Arrow} / \text{Right Arrow}$ to select the track or MP3 file you want to transfer, then start playback.

To transfer an MP3 file in a specific folder, press $\text{Folder} + / \text{Folder} -$ repeatedly to select the folder you want, then press $\text{Left Arrow} / \text{Right Arrow}$ to select the MP3 file you want to transfer. Then start playback.

5 Press REC TO USB on the unit.

"READY" appears on the display.

6 Press \oplus .

Transferring starts, then "USB REC" appears on the display.

Do not remove the USB device until transferring is completed.

When transferring is completed, "COMPLETE" appears on the display and audio files in MP3 format will be created.

Folder and file generation rules

When first transferring to a USB device, a folder ("CDDA001*", "MP3_REC1" or "CD_REC1") is created directly below the "ROOT" (in case of MP3 folder transfer, a folder that has the same name as the transferring source is created below the "ROOT"). Folders and files are generated as follows.

CD SYNC transfer

Transferring source	Folder name	File name
CD-DA	"CDDA001"*	"TRACK001"*

MP3 folder transfer

Transferring source	Folder name	File name
MP3	Same as the transferring source	

REC1 transfer

Transferring source	Folder name	File name
MP3	"MP3_REC1"	Same as the transferring source
CD-DA	"CD_REC1"	"TRACK001"*

* Folder and file numbers are assigned serially thereafter.

Notes

- If you start transferring in shuffle play or repeat play mode, the selected play mode is automatically changed to normal play.
- CD-TEXT information is not transferred in the created MP3 files. This system does not support the CD-TEXT standard.
- Transferring stops automatically if:
 - the USB device runs out of space during transferring.
 - the number of audio files and folders on the USB device reaches the limit for the number that the system can recognize.
- If a folder or file that you are trying to transfer already exists on the USB device with the same name, a sequential number is added after the name without overwriting the original folder or file.
- Do not use buttons on the remote control or unit during transferring to prevent transferring from stopping.

Note on copyright-protected content

The transferred music is limited to private use only. Use of the music beyond this limit requires permission of the copyright holders.

Playing a file

The audio format that can be played back on this system is MP3/WMA*.

* Files with DRM (Digital Rights Management) copyright protection cannot be played back on this system. Files downloaded from an online music store may not be played back on this system.

1 Select the USB function.

Press USB.

2 Connect the USB device to the ψ (USB) port.

3 Start playback.

Press \blacktriangleright .

Other operations

To	Press
Pause playback	\mathbb{I} . To resume play, press \blacktriangleright .
Stop playback	\blacksquare . To resume play, press \blacktriangleright *1. To cancel resume play, press \blacksquare again.
Select a folder	$\text{Folder} + / \text{Folder} -$ repeatedly.
Select a file	$\mathbb{L} \ll / \gg \mathbb{I}$.
Find a point in a file	Hold down \ll / \gg during playback, and release the button at the desired point.
Select Repeat Play	REPEAT repeatedly until "REP ONE*2," "REP FLDR*3" or "REP ALL *4" appears.
Change the play mode	PLAY MODE repeatedly while the USB device is stopped. You can select normal play ("FLDR" for all files in the folder on the USB device), shuffle play ("SHUF" or "FLDRSHUF" for folder shuffle), or program play ("PROGRAM").

*1 When playing a VBR MP3/WMA file, the system may resume playback from a different point.

*2 "REP ONE": Repeats the current file.

*3 "REP FLDR": Repeats the current folder.

*4 "REP ALL": Repeats all files on a USB device.

Notes









- This system cannot play audio files on the USB device in the following cases;
 - when the number of audio files in a folder exceeds 999.
 - when the total number of audio files on a USB device exceeds 999.
 - when the number of folders on a USB device exceeds 256 (including the "ROOT" folder and empty folders).

These numbers may vary depending on the file and folder structure. Do not save other types of files or unnecessary folders on a USB device that has audio files.

- The system can play back to a depth of 8 folders only.
- Files and folders are displayed in the order of their creation on the USB device.
- Folders that have no audio files are skipped.
- The audio formats that you can listen to with this system are as follows:
 - MP3: file extension ".mp3"
 - WMA: file extension ".wma"

Note that even when file name has the correct file extension, if the actual file differs, the system may produce noise or may malfunction.

To erase audio files or folders from the USB device

- 1 Select the USB function.
Press USB.
- 2 Connect the USB device to the  (USB) port.
- 3 Press   or  + /  – repeatedly to select the audio file or folder you want to erase, then start playback.
- 4 Press **OPTIONS** on the unit.
"ERASE" appears on the display.
- 5 Press   to select "FO ERASE" (folder erase) or "FI ERASE" (file erase).
- 6 Press .
"COMPLETE" appears on the display.

Creating your own program (Program Play)

1 Select the USB function.

Press USB.

2 Select the play mode.

Press PLAY MODE repeatedly until "PROGRAM" appears while the player is stopped.

3 Select the desired file number.

Press ◀◀/▶▶ repeatedly until the desired file number appears.

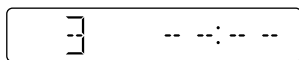

Selected file number

When programming MP3/WMA files in a specific folder, press +/ - repeatedly to select the desired folder, and then select the desired file.

4 Program the selected file.

Press ⊕ to enter the selected file.

5 Repeat steps 3 through 4 to program additional files, up to a total of 64 files.

6 To play your program of files, press ▶.

The program is cleared when you perform one of the following operations:

- changing the function.
- turning off the system.
- disconnecting the power cord.
- opening the disc tray.

To play the same program again, press ▶.

To cancel Program Play

Press PLAY MODE.

To delete the last step from the program list

Press CLEAR when playback is stopped.

Adjusting the sound

To	Press
Adjust the volume	VOLUME +/-.
Generate a more dynamic sound	BASS BOOST.
Set the sound effect	EQ +/EQ - repeatedly until desired sound effect is displayed.

Changing the display

To	Press
Change information on the display*	DISPLAY repeatedly when the system is on.

* For example, you can view information, such as track number, file/folder name, album name and artist name.

The system offers the following display mode.

Display mode	When the system is off
Power Saving mode	The display is turned off to conserve power. The clock continues to operate.

Notes on the display information

- Characters that cannot be displayed appear as “_”.
- The following are not displayed;
 - total playing time for an MP3 disc and a USB device.
 - remaining playing time for an MP3/WMA file.
- The following are not displayed correctly;
 - elapsed playing time of an MP3/WMA file encoded using VBR (variable bit rate).
 - folder and file names that do not follow either the ISO9660 Level 1/Level 2 in the expansion format.

Using the timers

The system offers two timer functions. If you use both timers, the Sleep Timer has priority.

Sleep Timer:

You can fall asleep to music. This function works even if the clock is not set.

Press SLEEP repeatedly. If you select "AUTO," the system automatically turns off after the current disc or USB device stops, or within 100 minutes.

Play Timer:

You can wake up to a CD, FM reception, iPod/iPhone or USB device at a preset time.

Make sure you have set the clock.

1 Prepare the sound source.

Prepare the sound source, and then press VOLUME +/- to adjust the volume.

2 Select the timer set mode.

Press TIMER MENU.

If the clock is not set, the system will be in clock set mode. In that case, set the clock.

3 Set the play timer.

Press ◀◀/▶▶ repeatedly to select "PLAY SET," then press ⊕.

4 Set the time to start playback.

Press ⬆/⬇ repeatedly to set the hour, then press ⊕. Follow the same procedure to set the minutes.

5 Follow the same procedure as in step 4 to set the time to stop playback.

6 Select the sound source.

Press ⬆/⬇ repeatedly until the desired sound source appears, then press ⊕.

7 Turn off the system.

Press I/⏏. The system automatically turns on before the preset time.

If the system is on at the preset time, the Play Timer will not be activated. Do not operate the system from the time the system turns on until the playback starts.

To check the setting

1 Press TIMER MENU.

2 Press ◀◀/▶▶ repeatedly to select "SELECT," and then press ⊕.

3 Press ◀◀/▶▶ repeatedly to select "PLAY SEL," and then press ⊕.

To cancel the timer

Repeat the same procedure as in "To check the setting" until "OFF" appears in step 3, and then press ⊕.

To change the setting

Start over from step 1 of "Using the timers."

Notes for the users of iPod/iPhone

- Make sure the iPod/iPhone is not playing when using the Play Timer.
- The Play Timer may not be activated depending on the status of the connected iPod/iPhone.

Tip

The Play Timer setting remains as long as the setting is not cancelled manually.

Compatible devices with this system

iPod/iPhone

You can use the following iPod/iPhone models with this system. Update your iPod/iPhone with the latest software before using it.

Made for

- iPhone 5
- iPhone 4S
- iPhone 4
- iPhone 3GS
- iPod touch (5th generation)
- iPod touch (4th generation)
- iPod touch (3rd generation)
- iPod classic
- iPod nano (7th generation)
- iPod nano (6th generation)
- iPod nano (5th generation)
- iPod nano (4th generation)

USB devices

Check the websites below for the information about compatible USB devices.

For customers in Europe:

<http://support.sony-europe.com/>

For customers in the USA:

<http://esupport.sony.com/>

For customers in Canada:

<http://esupport.sony.com/CA>

For customers in Latin America:

<http://esupport.sony.com/LA>

For customers in other countries/ regions:

<http://www.sony-asia.com/support>

Troubleshooting

- 1 Make sure the power cord and speaker cords are correctly and firmly connected.**
- 2 Find your problem in the checklist below, and take the indicated corrective action.**
If the issue persists, contact your nearest Sony dealer.

If "PROTECT" appears on the display

Immediately unplug the power cord, and check the following items after "PROTECT" disappears.

- Are the + and – speaker cords short-circuited?
- Is anything blocking the ventilation holes of the system?

After you have checked these above items and found no problems, reconnect the power cord, and turn on the system. If the issue persists, contact your nearest Sony dealer.

If "OVER CURRENT" appears on the display

A problem has been detected with the level of electrical current from the ⚡ (USB) port and Lightning connector. Turn off the system and remove the USB device and iPod/iPhone from the ⚡ (USB) port and Lightning connector. Make sure there is no problem with the USB device and iPod/iPhone. If this display pattern persists, contact your nearest Sony dealer.

General

The system does not turn on.

- Is the power cord plugged in?

The system has entered standby mode unexpectedly.

- This is not a malfunction. The system enters standby mode automatically in about 30 minutes when there is no operation or audio signal output. See "To turn off the automatic standby function" (page 27).

The clock setting or the Play Timer operation has been cancelled unexpectedly.

- If about a minute elapses with no operation, the clock setting or Play Timer setting is cancelled automatically. Perform the operation again from the beginning.

There is no sound.

- Are the + and – speaker cords short-circuited?
- Are you using only the supplied speakers?
- Is anything blocking the ventilation holes of the system?
- The specified station may have temporarily stopped broadcast.

Sound comes from one channel, or the left and right volumes are unbalanced.

- Place the speakers as symmetrically as possible.
- Connect only the supplied speakers.

Severe hum or noise.

- Move the system away from sources of noise.
- Connect the system to a different wall outlet.
- Install a noise filter (available separately) to the power cord.

The remote control does not function.

- Remove any obstacles between the remote control and the remote control sensor on the unit, and position the unit away from fluorescent lights.
- Point the remote control at the system's sensor.
- Move the remote control closer to the system.

Except I/⏻, no buttons on the unit work, and "LOCK ON" appears on the display.

- The child lock function has been enabled. To disable the child lock, hold down ■ on the unit until "LOCK OFF" appears on the display.

A disc cannot be ejected and "LOCKED" appears on the display.

- Contact your Sony dealer or local authorized Sony service facility.

CD/MP3 disc

The sound skips, or the disc will not play.

- Wipe the disc clean, and replace it.
- Move the system to a location away from vibration (for example, on top of a stable stand).
- Move the speakers away from the system, or place them on separate stands. At high volume, speaker vibration may cause the sound to skip.

Play does not start from the first track.

- Set the play mode to normal play mode.

Starting playback takes more time than usual.

- The following discs can increase the time it takes to start playback;
 - a disc recorded with a complicated tree structure.
 - a disc recorded in multisession mode.
 - a disc that has not been finalized (a disc to which data can be added).
 - a disc that has many folders.

iPod/iPhone

There is no sound.

- Make sure the iPod/iPhone is connected securely.
- Make sure the iPod/iPhone is playing music.
- Make sure the iPod/iPhone is updated with the latest software. If not, update the iPod/iPhone before using with the system.
- Adjust the volume.

The sound is distorted.

- Make sure the iPod/iPhone is connected securely.
- Turn down the volume.
- Set the "EQ" setting of the iPod/iPhone to "Off" or "Flat."

The iPod/iPhone does not function.

- Shut down any other "iOS" applications running on the iPod/iPhone. For details, refer to the operation manual supplied with the iPod/iPhone.
- Make sure the iPod/iPhone is connected securely.
- Because the operation of the system and the iPod/iPhone are different, you may not operate the iPod/iPhone using buttons on the remote control or unit. In this case, perform operations on the iPod/iPhone.

The connected iPod/iPhone cannot be charged.

- Make sure the iPod/iPhone is connected securely.
- Make sure the system is turned on.

USB device

The connected USB device cannot be charged.

- Make sure the USB device is connected securely.

Are you using a supported USB device?

- If you connect an unsupported USB device, the following problems may occur. Check the information on websites for compatible USB devices using the URLs listed under "USB devices" in "Compatible devices with this system" (page 23).
 - The USB device is not recognized.
 - File or folder names are not displayed on this system.
 - Playback is not possible.
 - The sound skips.
 - There is noise.
 - A distorted sound is output.

There is no sound.

- The USB device is not connected correctly. Turn off the system, then reconnect the USB device.

There is noise, skipping, or distorted sound.

- Turn off the system, then reconnect the USB device.
- The music data itself contains noise, or the sound is distorted. Noise may have been entered during music creation process using this system or the computer. Create the music data again.
- The bit rate used when encoding the files was low. Send files encoded with higher bit rates to the USB device.

"SEARCH" is displayed for an extended time, or it takes a long time before playback starts.

- The reading process can take a long time in the following cases.
 - There are many folders or files on the USB device.
 - The file structure is extremely complex.
 - The memory capacity is excessive.
 - The internal memory is fragmented.

Erroneous display

- Characters that cannot be displayed appear as "_".

The USB device is not recognized.

- Turn off the system and reconnect the USB device, then turn on the system.
- Check the information on websites for compatible USB devices using the URLs listed under "USB devices" in "Compatible devices with this system" (page 23).

Transferring results in an error.

- Check the information on websites for compatible USB devices using the URLs listed under "USB devices" in "Compatible devices with this system" (page 23).
- The USB device is not formatted correctly. Refer to the operating instructions of the USB device on how to format.
- Turn off the system and remove the USB device. If the USB device has a power switch, turn the USB device off and then on again after removing it from the system. Then perform transferring again.
- The USB device was disconnected or the power was turned off during transferring. Delete the partially transferred file, and perform transferring again. If this does not fix the problem, the USB device may be broken. Refer to the operating instructions of the USB device on how to deal with this problem.

Audio files or folders on the USB device cannot be erased.

- Check if the USB device is write-protected.
- The USB device was disconnected or the power was turned off during the erase operation. Delete the partially-erased file. If this does not fix the problem, the USB device may be broken. Refer to operating instructions of the USB device on how to deal with this problem.

Play does not start.

- Turn off the system and reconnect the USB device, then turn on the system.
- Check the information on websites for compatible USB devices using the URLs listed under "USB devices" in "Compatible devices with this system" (page 23).
- Press ► to start playback.

Play does not start from the first track.

- Set the play mode to normal play mode.

Files cannot be played back.

- The audio files may have inappropriate file extensions. The file extensions supported by this system are as follows:
 - MP3: file extension ".mp3"
 - WMA: file extension ".wma"
- USB storage devices formatted with file systems other than FAT16 or FAT32 are unsupported.*
- If you use a partitioned USB storage device, only files on the first partition can be played.
- Files that are encrypted or protected by passwords, etc. cannot be played back.

* This system supports FAT16 and FAT32, but some USB storage devices may not support all of these FAT. For details, see the operation manual of each USB storage device or contact the manufacturer.

Tuner

Severe hum or noise, or stations cannot be received.

- Connect the antenna properly.
- Try another place and orientation for better antenna reception.
- Keep the antenna away from the speaker cords and the power cord to avoid picking up noise.
- Turn off nearby electrical equipment.

To reset the system to factory settings

If the system still does not operate properly, reset the system to factory settings.

- 1 Disconnect and reconnect the power cord, and then turn on the system.
- 2 Hold down ■ and EQ on the unit until "RESET OK" appears. All user-configured settings, such as preset radio stations, timer, and the clock, are deleted.

To turn off the automatic standby function

This system is equipped with an automatic standby function. With this function, the system enters standby mode automatically in about 30 minutes when there is no operation or audio signal output.

By default, the automatic standby function is turned on.

Use buttons on the unit to turn off the automatic standby function.

Hold down I/⏻ while the system is on, until "AUTO STANDBY OFF" appears.

To turn on the function, repeat the procedure until "AUTO STANDBY ON" appears.

Notes

- The automatic standby function is invalid for the FM function.
- The system may not enter standby mode automatically in the following cases:
 - when an audio signal is detected.
 - when an iPod/iPhone is connected.
 - during playback of audio tracks or files.
 - while the preset Play Timer or Sleep Timer is in process.

Messages

DISC ERR

You have loaded a disc that cannot be played.

ERROR

- The USB device is write-protected.
- The memory of the USB device is full.

FULL

You tried to program more than 64 tracks or files (steps).

NO FILE

There are no playable files on the CD-R/CD-RW discs or on the USB device.

NO STEP

All of the programmed steps have been erased.

NO USB

No USB device is connected or an unsupported USB device is connected.

PLAY SET

You tried to select the timer when the Play Timer is not set.

PLS STOP

You pressed PLAY MODE during playback.

SELECT

You pressed TIMER MENU during timer operation.

TIME NG

The Play Timer start and end times are set to the same time.

Precautions

Discs that this system CAN play

- Audio CD
- CD-R/CD-RW (audio data/MP3 files)

Discs that this system CANNOT play

- CD-ROM
- CD-R/CD-RW other than those recorded in music CD format, conforming to ISO9660 Level 1/Level 2
- CD-R/CD-RW recorded in multisession that have not ended by "closing the session"
- CD-R/CD-RW of poor recording quality, CD-R/CD-RW that have scratches or are dirty, or CD-R/CD-RW recorded with an incompatible recording device
- CD-R/CD-RW which is finalized incorrectly
- Discs containing files other than MPEG 1 Audio Layer-3 (MP3) files
- Discs of non-standard shape (for example, heart, square, star)
- Discs that have adhesive tape, paper, or sticker attached to them
- Rental or used discs with attached seals where the glue extends beyond the seal
- Discs that have labels printed using ink that feels tacky when touched

Notes on discs

- Before playing, wipe the disc with a cleaning cloth from the center outward to the edge.
- Do not clean discs with solvents, such as benzene, thinner, or commercially available cleaners or anti-static spray intended for vinyl LPs.
- Do not expose discs to direct sunlight or heat sources such as hot air ducts, nor leave them in a car parked in direct sunlight.

On safety

- Completely disconnect the power cord (mains lead) from the wall outlet (mains) if it is not going to be used for an extended period of time. When unplugging the unit, always grip the plug. Never pull the cord itself.
- Should any solid object or liquid get into the system, unplug the system, and have it checked by qualified personnel before operating it again.
- The AC power cord can be changed only by a qualified service facility.

On placement

- Do not place the system in an inclined position or in locations that are extremely hot, cold, dusty, dirty, or humid or lacking adequate ventilation, or subject to vibration, direct sunlight or a bright light.
- Be careful when placing the unit or speakers on surfaces that have been specially treated (for example, with wax, oil, polish) as staining or discoloration of the surface may result.
- If the system is brought directly from a cold to a warm location or is placed in a very damp room, moisture may condense on the lens inside the CD player, and cause the system to malfunction. In this situation, remove the disc, and leave the system turned on for about an hour until the moisture evaporates.

On heat buildup

- Heat buildup on the unit during operation is normal and is not cause for alarm.
- Do not touch the cabinet if it has been used continuously at a high volume because the cabinet may have become hot.
- Do not obstruct the ventilation holes.

On the speaker system

This speaker system is not magnetically shielded, and the picture on nearby TV sets may become magnetically distorted. In this situation, turn off the TV, wait 15 to 30 minutes, and turn it back on. If there is no improvement, move the speakers far away from the TV.

Cleaning the cabinet

Clean this system with a soft cloth slightly moistened with a mild detergent solution. Do not use any type of abrasive pad, scouring powder, or solvent, such as thinner, benzene, or alcohol.

Specifications

Main unit

AUDIO POWER SPECIFICATIONS

POWER OUTPUT AND TOTAL HARMONIC DISTORTION:

(The United States model only)

With 8 ohms loads, both channels driven, from 120 – 10,000 Hz; rated 26 watts per channel minimum RMS power, with no more than 0.7% total harmonic distortion from 250 milliwatts to rated output.

Amplifier section

U.S. model:

Output power (reference):
60 W + 60 W (per channel at 8 ohms, 1 kHz)

Other models:

Power output (rated):
30 W + 30 W (at 8 ohms, 1 kHz, 1% THD)

Output power (reference):
60 W + 60 W (per channel at 8 ohms, 1 kHz)

Outputs

SPEAKERS: Accepts impedance of 8 ohms

CD player section

System: Compact disc and digital audio system

Laser Diode Properties

Emission Duration: Continuous

Laser Output*: Less than 44.6 μ W

* This output is the value measurement at a distance of 200mm from the objective lens surface on the Optical Pick-up Block with 7mm aperture.

Tuner section

FM stereo, FM superheterodyne tuner

Antenna: FM lead antenna

Tuning range:

North American model: 87.5 MHz – 108.0 MHz (100 kHz step)

Other models: 87.5 MHz – 108.0 MHz (50 kHz step)

Dock section

Connector type: 8-pin Lightning connector*

Output voltage: DC 5 V

Maximum output current: 1 A

* The Lightning connector works with iPhone 5, iPod touch (5th generation) and iPod nano (7th generation).

USB section

⚡ (USB) port*: Type A, maximum current 1 A

* Use the USB cable supplied with your iPod/iPhone when connecting it to the ⚡ (USB) port.

Supported audio formats (MP3 discs and USB devices only)

Supported bit rate:

MP3 (MPEG 1 Audio Layer-3):

32 kbps – 320 kbps, VBR

WMA*: 32 kbps – 192 kbps, VBR

Sampling frequencies:

MP3 (MPEG 1 Audio Layer-3):

32/44.1/48 kHz

WMA*: 44.1 kHz

* USB devices only

Speaker

Front speaker (SS-ECL5)

Speaker system: 2-way speaker system, Bass reflex

Speaker units:

Woofer: 130 mm (5 1/4 in), cone type

Tweeter: 40 mm (1 1/2 in), horn type

Rated impedance: 8 ohms

Dimensions (W/H/D): Approx. 200 mm × 300 mm × 185 mm (7 7/8 in × 11 3/4 in × 7 1/4 in)

Mass: Approx. 2.2 kg (4 lb 13 5/8 oz) net per speaker

Quantity: 2 pieces

General

Power requirements:

North American model: AC 120 V, 60 Hz

Other models: AC 120 V – 240 V, 50/60 Hz

Power consumption: 55 W

Dimensions (W/H/D, including largest protrusions) (excl. speakers):

Approx. 193 mm × 300 mm ×

260 mm (7 5/8 in × 11 3/4 in ×

10 1/4 in)

Mass (excl. speakers): Approx. 2.4 kg (5 lb 4 5/8 oz)

Quantity of the main unit: 1 piece

Supplied accessories: Remote control (1), R6 (size AA) battery (1), FM lead antenna (1), Speaker pads (8)

Design and specifications are subject to change without notice.

Standby power consumption: 0.5 W

License and Trademark Notice

- iPhone, iPod, iPod classic, iPod nano, and iPod touch are trademarks of Apple Inc., registered in the U.S. and other countries. Lightning is a trademark of Apple Inc.
- “Made for iPod,” and “Made for iPhone” mean that an electronic accessory has been designed to connect specifically to iPod or iPhone, respectively, and has been certified by the developer to meet Apple performance standards. Apple is not responsible for the operation of this device or its compliance with safety and regulatory standards. Please note that the use of this accessory with iPod or iPhone may affect wireless performance.
- MPEG Layer-3 audio coding technology and patents licensed from Fraunhofer IIS and Thomson.
- Windows Media is either a registered trademark or trademark of Microsoft Corporation in the United States and/or other countries.
- This product is protected by certain intellectual property rights of Microsoft Corporation. Use or distribution of such technology outside of this product is prohibited without a license from Microsoft or an authorized Microsoft subsidiary.
- All other trademarks and registered trademarks are of their respective holders. In this manual, ™ and ® marks are not specified.

<http://www.sony.net/>

