

# ***FM Stereo FM/AM Receiver***

---

Operating Instructions

***STR-LV500***

## WARNING

### To prevent fire or shock hazard, do not expose the unit to rain or moisture.

To prevent fire, do not cover the ventilation of the apparatus with news papers, table-cloths, curtains, etc. And don't place lighted candles on the apparatus.

To prevent fire or shock hazard, do not place objects filled with liquids, such as vases, on the apparatus.

Do not install the appliance in a confined space, such as a bookcase or built-in cabinet.



Don't throw away batteries with general house waste; dispose of them correctly as chemical waste.

## About this manual

The instructions in this manual describe the controls on the remote. You can also use the controls on the receiver if they have the same or similar names as those on the remote.

This receiver incorporates Dolby\* Digital and Pro Logic Surround and the DTS\*\* Digital Surround System.

\* Manufactured under license from Dolby Laboratories.

"Dolby", "Pro Logic" and the double-D symbol are trademarks of Dolby Laboratories.

\*\* "DTS" and "DTS Digital Surround" are trademarks of Digital Theater Systems, Inc.

# Table of Contents

---

## Hooking up the components

Required cords .....	4
Connecting analog components .....	5
Connecting digital components.....	6
Connecting the antennas .....	7
Placing speakers .....	8
Connecting speakers .....	9
Connecting the AC power cord.....	10
Adjusting the speaker levels and balance .....	11
— TEST TONE	
Checking the connections .....	11

---

## Basic Operations

Selecting the component .....	12
Receiving broadcasts .....	12
Using the Radio Data System (RDS)....	14
About the indications in the display.....	16

---

## Enjoying Surround Sound

Using only the front speakers .....	17
Enjoying higher fidelity sound.....	17
— AUTO FORMAT DIRECT	
Selecting a sound field.....	18

---

## Other Operations/Settings

Switching the audio input mode for digital components .....	20
— INPUT MODE	
Selecting the digital audio input decoding priority .....	20
Using the Sleep Timer .....	21
Using the supplied remote to controlling the other component .....	21
Changing the factory setting of a input button on the remote .....	23
Setting up the speakers.....	24
Customizing sound fields.....	26

---

## Additional Information

Precautions .....	28
Troubleshooting .....	29
Specifications .....	30

List of button locations and reference pages.....	32
Index .....	34

## Hooking up the components

### Required cords

#### Before you get started

The hookup diagrams on the subsequent pages assume the use of the following optional connection cords (**A** to **E**) (not supplied).

#### **A** Audio/video cord

Yellow (video)  
White (L/audio)  
Red (R/audio)

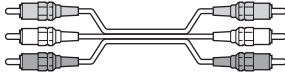

#### **B** Audio cord

White (L)  
Red (R)



#### **C** Video cord

Yellow



#### **D** Optical digital cord



#### **E** Coaxial digital cord



#### Notes

- Turn off the power to all components before making any connections.
- Be sure to make connections firmly to avoid hum and noise.
- When connecting an audio/video cord, be sure to match the color-coded pins to the appropriate jacks on the components: yellow (video) to yellow; white (left, audio) to white; and red (right, audio) to red.
- When connecting optical digital cords, insert the cord plugs straight in until they click into place.
- Do not bend or tie optical digital cords.

#### Inserting batteries into the remote

Insert two R6 (size AA) batteries with the + and – properly oriented in the battery compartment.

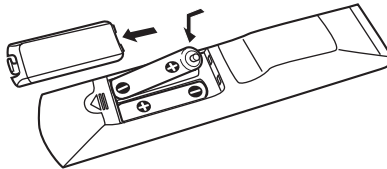

#### Tip

Under normal conditions, the batteries should last for about 6 months. When the remote no longer operates the control center, replace both batteries with new ones.

#### Notes

- Do not leave the remote in an extremely hot or humid place.
- Do not use a new battery with an old one.
- Do not expose the remote sensor of the control center to direct sunlight or lighting apparatuses. Doing so may cause a malfunction.
- If you don't use the remote for an extended period of time, remove the batteries to avoid possible damage from battery leakage and corrosion.
- Turn off the power to all components before making any connections.
- Be sure to make connections firmly to avoid hum and noise.

# Connecting analog components

If you connect your TV to the MONITOR jack, you can watch the video from the selected input (page 12).

For details on the required cords (**A**–**E**), see page 4.

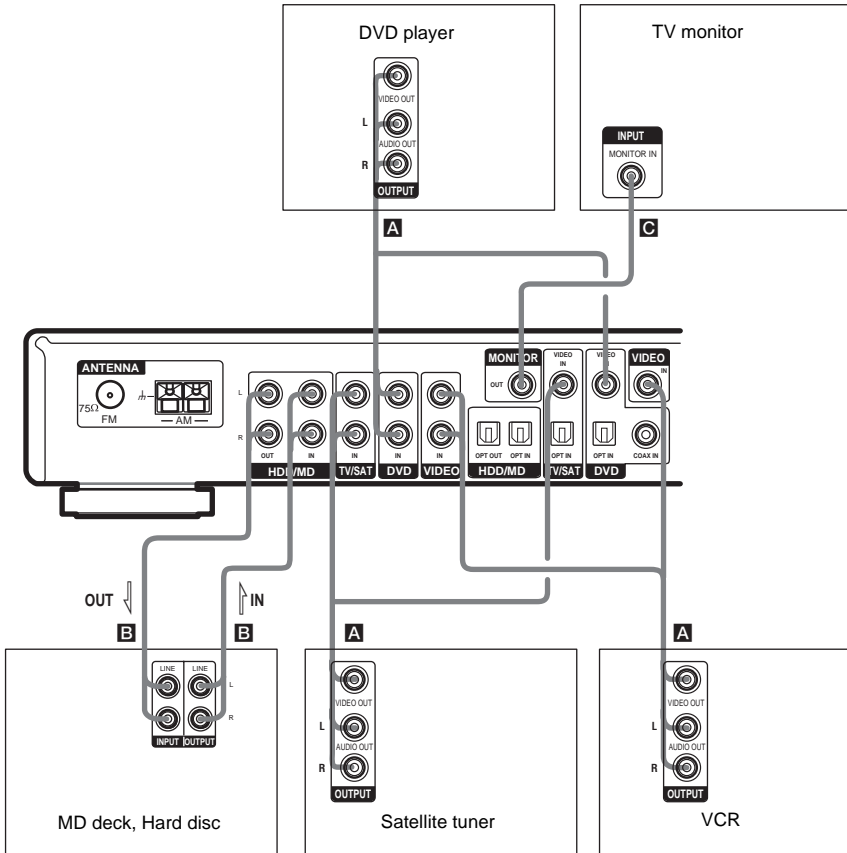

# Connecting digital components

Connect the digital output jacks of your DVD player (etc.) to this system's digital input jacks to bring the multi channel surround sound of a movie theater into your home. To fully enjoy multi channel surround sound, five speakers (two front speakers, two surround speakers, and a center speaker) and a sub woofer are required.

For details on the required cords (A-E), see page 4.

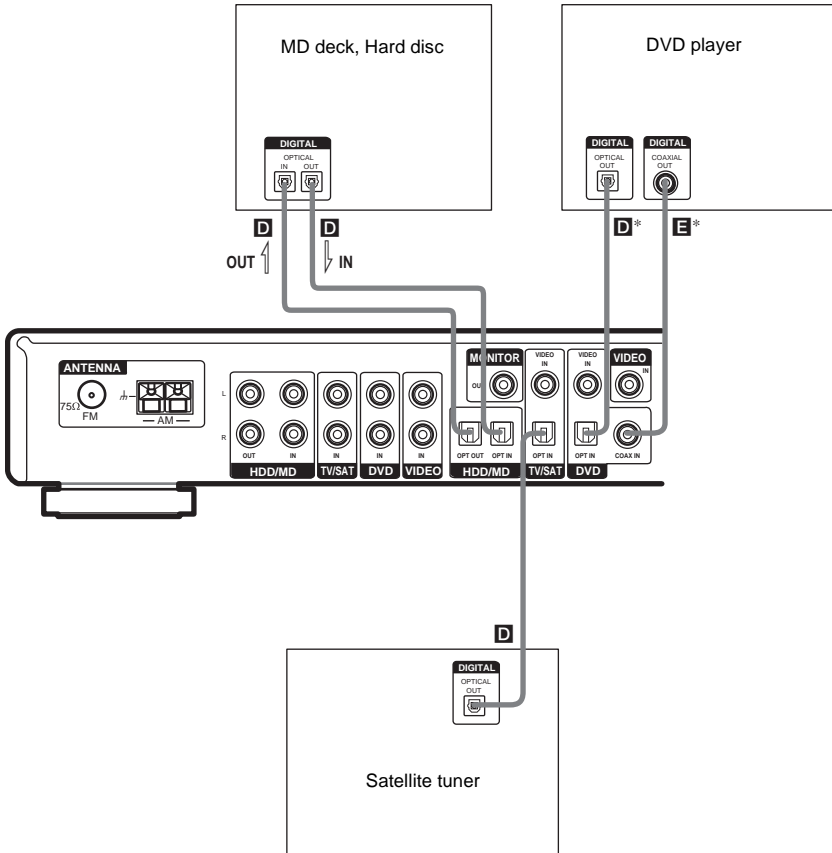

\* Connect to either the COAX IN or the OPT IN jack. We recommend making connections to the COAX IN jack.

## Notes

- All the digital audio jacks are compatible with 32 kHz, 44.1 kHz, 48 kHz and 96 kHz sampling frequencies.
- To playback the multi channel surround sound through this receiver, you may have to change the digital output setting on the connected component. For details, refer to the operating instructions supplied with the component.

# Connecting the antennas

Connect the supplied AM loop antenna and FM wire antenna.

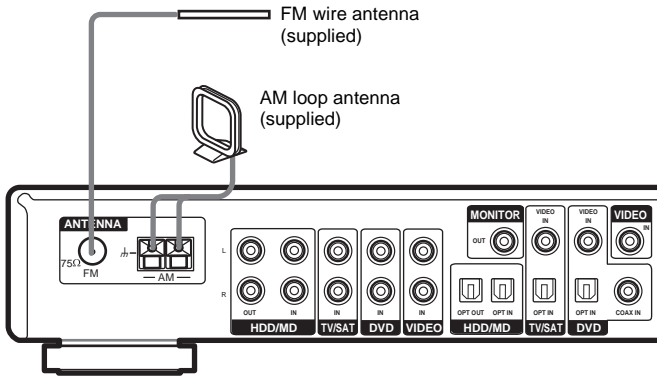

## Notes

- To prevent noise pickup, keep the AM loop antenna away from the receiver and other components.
- Be sure to fully extend the FM wire antenna.
- After connecting the FM wire antenna, keep it as horizontal as possible.

# Placing speakers

To fully enjoy surround sound, configure your speakers as below.

- Place the front speaker in a location 1 to 7 meters from the listening position (A).
- You can enjoy a higher quality sound effect if you place the center speaker from a distance equal to the front speaker distance (A) to a distance 1.5 meters closer to your listening position (B).
- You can enjoy a higher quality sound effect if you place the surround speakers from a distance equal to the front speaker distance (A) to a distance 4.5 meters closer to your listening position (C).
- You can place the surround speakers either behind you or to the side, depending on the shape of your room (etc.).
- Place the sub woofer at the same distance from the listening position as the front speaker (left or right).

When placing surround speakers to your side

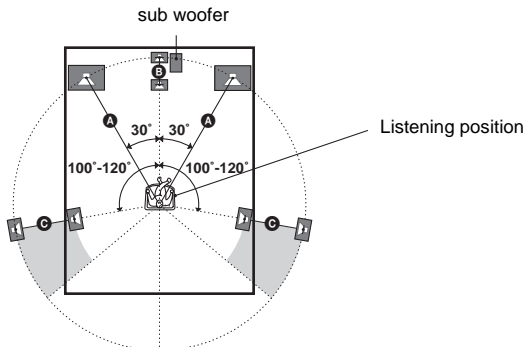

When placing surround speakers behind you

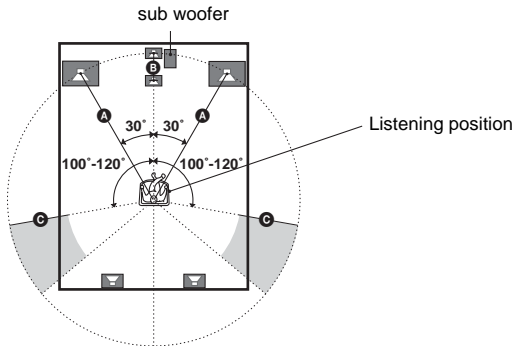

## Note

Do not place the center speaker and surround speakers farther away from the listening position than the front speakers.



# Connecting speakers

When connecting speaker cords, make sure to attach the supplied speaker plugs to the speaker cords. For details on how to attach the speaker plugs, see the supplied flysheet.

## Required cords

### A Speaker cords (not supplied)

(+)  
(-)



### B Monaural audio cord (not supplied)

Black

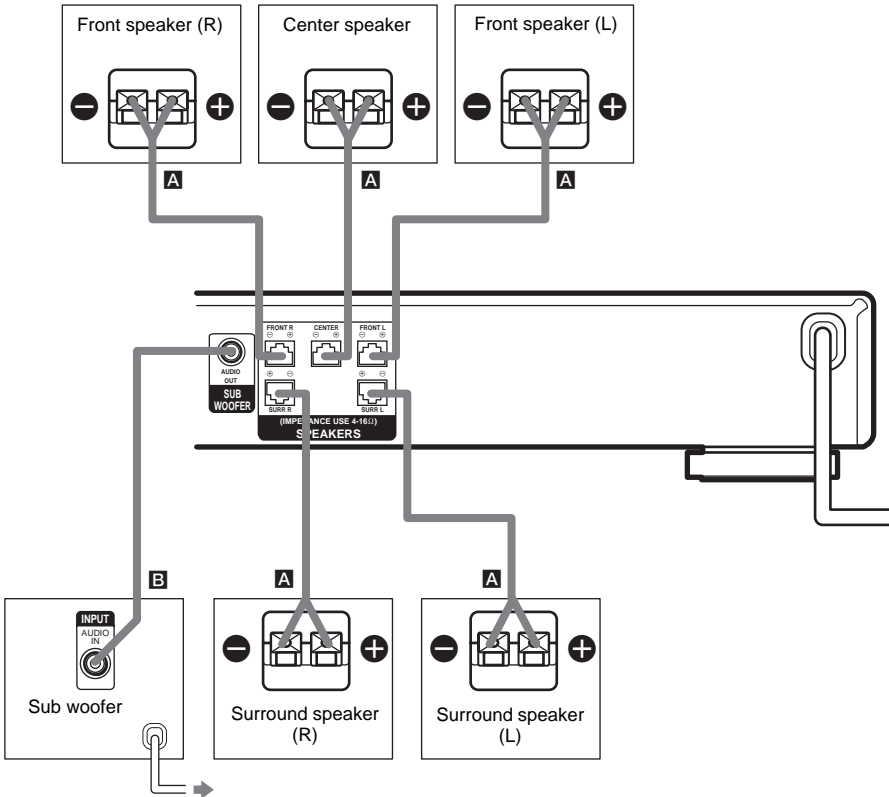

To a wall outlet  
(Switch the power  
(POWER) to off before  
connecting the power  
cord).

### Note

If you use speakers with low maximum input rating, adjust the volume carefully to avoid excessive output on the speakers.

### To avoid short-circuiting the speakers

Short-circuiting may damage the speakers and cause a malfunction.

**Make sure the stripped ends of each speaker cord does not touch the stripped end of another speaker cord.**

### Examples of poor conditions of the speaker cord

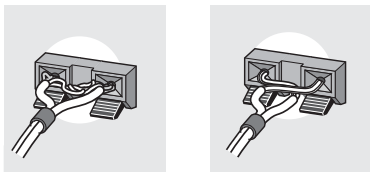

## Connecting the AC power cord

Before connecting the AC power cord of this receiver to a wall outlet, connect the speaker system to the receiver.

Connect the AC power cord(s) of your audio/video components to a wall outlet.

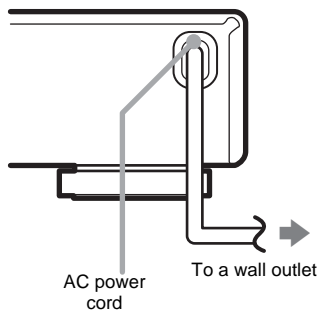

## Performing initial setup operations

Before using the receiver for the first time, initialize the receiver by performing the following procedure.

This procedure can also be used to return settings you have made to their factory defaults.

- 1 Press I/⏻ to turn off the receiver.**
- 2 Hold down I/⏻ for 5 seconds.**

All of the following items are reset or cleared:

- All sound field parameters are reset to their factory settings.
- All SET UP parameters are reset to their factory settings.
- The sound fields memorized for each program source and preset stations are cleared.
- The master volume is set to “MIN”.

## Adjusting the speaker levels and balance

### — TEST TONE

Use the remote while seated in your listening position to adjust the level of each speaker.

- 1 Press I/⏻ to turn on the receiver.**
- 2 Rotate VOLUME on the receiver clockwise.**
- 3 Turn on the power of the sub woofer.**
- 4 Press TEST TONE on the remote.**

You will hear the test tone from each speaker in sequence.

Front (left) → Center → Front (right) → Surround (right) → Surround (left) → Sub woofer

- 5 Adjust the LEVEL parameters so that the level of the test tone from each speaker sounds the same when you are in your main listening position.**

To adjust the balance and level of speakers, press MAIN MENU repeatedly to select LEVEL menu, press ▲/▼ to select the parameter you want to adjust (page 26). Then press ◀/▶ to select the setting.

- 6 Press TEST TONE on the remote again to turn off the test tone.**

#### Tip

You can adjust the level of all speakers at the same time. Rotate VOLUME on the system or press VOLUME +/- on the remote.

#### Notes

- The front balance, center level, surround level, and sub woofer level are shown in the display during adjustment.
- To enjoy the better sound quality, do not turn the volume of the sub woofer too high.

## Checking the connections

After connecting all of your components to the receiver, do the following to verify that the connections were made correctly.

- 1 Press I/⏻ to turn on the receiver.**
- 2 Press INPUT SELECTOR to select a component (program source) that you connected (e.g., DVD player).**
- 3 Turn on the component and start playing it.**
- 4 Rotate VOLUME to turn up the volume.**

If you do not obtain normal sound output after performing this procedure, see “Troubleshooting” on page 29 and take the appropriate measures to correct the problem.

## Basic Operations

### Selecting the component

- 1 Press **INPUT SELECTOR** repeatedly to select the input.

The selected input appears in the display.

To select the	Display
DVD player	DVD
VCR	VIDEO
Hard disc or MD deck	HDD/MD
Satellite tuner	TV/SAT
Built-in tuner (FM)	Tuner (FM)
Built-in tuner (AM)	Tuner (AM)

- 2 Turn on the component and start playback.
- 3 Rotate **VOLUME** to adjust the volume.

#### To mute the sound

Press **MUTING** to mute the sound. **MUTING** appears on the display when the sound is muted. To cancel muting, press it again or turn up the volume.

## Receiving broadcasts

Before receiving broadcasts, make sure you have connected FM and AM antennas to the receiver (page 7).

Use the remote for the tuner operation.

### Automatic tuning

If you don't know the frequency of the station you want, you can let the receiver scan all available stations in your area.

- 1 Press **FM** or **AM** repeatedly to select **FM** or **AM** band.

You can also use **INPUT SELECTOR** on the system. The last received station is tuned in.

- 2 Press **TUNING MODE** repeatedly to select "AUTO T."

- 3 Press **TUNING +** or **TUNING -**.

Press **TUNING +** to scan from low to high; press **TUNING -** to scan from high to low. The receiver stops scanning whenever a station is received.

**When the receiver reaches either end of the band**

Scanning is repeated in the same direction.

- 4 To continue scanning, press **TUNING +** or **TUNING -** again.

### Manual tuning

You can tune in the station in 50 kHz steps for FM band and 9 kHz steps for AM band.

- 1 Press **FM** or **AM** repeatedly to select **FM** or **AM** band.

You can also use **INPUT SELECTOR** on the system. The last received station is tuned in.

- 2 Press **TUNING MODE** repeatedly to select "MANUAL T."

- 3 Press **TUNING +** or **TUNING -** repeatedly to tune in the station you want.

Press TUNING + to change the frequency from low to high.

Press TUNING – to change the frequency from high to low.

#### Tip

If “STEREO” flashes in the display and the FM stereo reception is poor, press FM MODE to improve the sound. You will not be able to enjoy the stereo effect, but the sound will be less distorted.

#### Note

If “STEREO” does not appear at all when an FM broadcast is received normally, press FM MODE to turn on the “STEREO” indication.

## Preset tuning

After you have tuned in stations using Automatic Tuning or Manual Tuning, you can preset them to the receiver. Then you can tune in any of the stations directly. Up to 30 FM or AM stations can be preset. The receiver will also scan all the stations that you have preset. Before tuning to preset stations, be sure to preset them by performing steps on “Presetting radio stations”.

## Presetting radio stations

### 1 Press FM or AM repeatedly to select FM or AM band.

You can also use INPUT SELECTOR on the system. The last received station is tuned in.

### 2 Tune in the station that you want to preset using Automatic Tuning or Manual Tuning (page 12).

### 3 Press MEMORY.

“MEMORY” appears in the display for a few seconds.

Do steps 4 to 5 before “MEMORY” goes out.

### 4 Press SHIFT to select the memory page and press PRESET/CH + or PRESET/CH – to select a preset number.

If “MEMORY” goes out before you press the preset number, start again from step 3.

### 5 Press MEMORY again to store the station.

If “MEMORY” goes out before you can store the station, start again from step 3.

## 6 Repeat steps 2 to 5 to preset another station.

## Tuning to preset stations

### 1 Press FM or AM repeatedly to select FM or AM band.

You can also use INPUT SELECTOR on the system. The last received station is tuned in.

### 2 Press PRESET/CH + or PRESET/CH – repeatedly to select the preset station you want.

Each time you press the button, the receiver tunes in one preset station at a time, in the corresponding order and direction as follows:

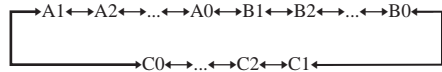

#### Tips

- In step 2, press SHIFT to select a memory page (A, B, or C).
- You can also use PRESET TUNING +/- on the receiver to tune to preset stations.

## Using the Radio Data System (RDS)

This receiver also allows you to use RDS (Radio Data System), which enables radio stations to send additional information along with the regular program signal. You can also display RDS information.

### Receiving RDS broadcasts

**Simply select a station on the FM band using automatic tuning, manual tuning (page 12), or preset tuning (page 13).**

When you tune in a station that provides RDS services, the RDS indicator lights up and the program station name appears in the display.

#### Note

RDS may not work properly if the station you tuned to is not transmitting the RDS signal properly or if the signal strength is weak.

### Displaying RDS information

**While receiving an RDS station, press DISPLAY.**

Each time you press the button, RDS information on the display changes cyclically as follows:

Program Station name → Frequency → Program Type indication<sup>a)</sup> → Radio Text indication<sup>b)</sup> → Current Time indication (in 24-hour system) → Sound field currently applied → Volume

<sup>a)</sup> Type of program being broadcast (see page 14).

<sup>b)</sup> Text messages sent by the RDS station.

#### Notes

- If there is an emergency announcement by government authorities, "ALARM" flashes in the display.
- When the message consists of 9 characters or more, the message scrolls across the display.
- If a station does not provide a particular RDS service, "NO XXXX" (such as "NO TEXT") appears in the display.

### Description of program types

Program type indication	Description
NEWS	News programs
AFFAIRS	Topical programs that expand on current news
INFO	Programs offering information on a wide spectrum of subjects, including consumer affairs and medical advice
SPORT	Sports programs
EDUCATE	Educational programs, such as "how-to" and advice programs
DRAMA	Radio plays and serials
CULTURE	Programs about national or regional culture, such as language and social concerns
SCIENCE	Programs about the natural sciences and technology
VARIED	Other types of programs such as celebrity interviews, panel games, and comedy
POP M	Popular music programs
ROCK M	Rock music programs
EASY M	Easy Listening
LIGHT M	Instrumental, vocal, and choral music
CLASSICS	Performances of major orchestras, chamber music, opera, etc.
OTHER M	Music that does not fit into any categories above, such as Rhythm & Blues and Reggae
WEATHER	Weather information
FINANCE	Stock market reports and trading, etc.
CHILDREN	Programs for children
SOCIAL	Programs about people and the things that affect them
RELIGION	Programs of religious content
PHONE IN	Programs where members of the public express their views by phone or in a public forum
TRAVEL	Programs about travel. Not for announcements that are located by TP/TA.
LEISURE	Programs on recreational activities such as gardening, fishing, cooking, etc.

<b>Program type indication</b>	<b>Description</b>
JAZZ	Jazz programs
COUNTRY	Country music programs
NATION M	Programs featuring the popular music of the country or region
OLDIES	Programs featuring oldies music
FOLK M	Folk music programs
DOCUMENT	Investigative features
NONE	Any programs not defined above

## About the indications in the display

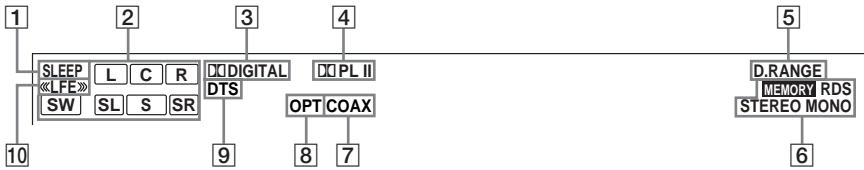

- 1 SLEEP:** Lights up when sleep timer is activated.
- 2 Playback channel indicators:** The letters (L, C, R, etc.) indicate the channels being played back. The boxes around the letters vary to show how the receiver downmixes the source sound (based on the speakers settings). L (Front Left), R (Front Right), C (Center (monaural)), SL (Surround Left), SR (Surround Right), S (Surround (monaural) or the surround components obtained by Pro Logic processing), SW (sub woofer)
- Example:**  
 Recording format (Front /Surround): 3/2  
 Output channel: Surround speakers absent  
 Sound Field: A.F.D. AUTO
- L
C
R  
SW
SL
SR
- 3 DIGITAL:** Lights up when the receiver is decoding signals recorded in the Dolby Digital format.
- 4 PL (II):** “PL” lights up when a 2-channel signal is applied with “DOLBY PL” or C.ST.EX A–C. “PL II” lights up when Dolby Pro Logic II processing (“PLII MOV” or “PLII MUS”) is applied. However, this indicator does not light if the center and surround speakers are set to “NO”, and “A.F.D. AUTO” is selected.
- 5 D.RANGE:** Lights up when dynamic range compression is activated (page 26).
- 6 Tuner indicators:** Lights up when using the receiver to tune in radio stations, etc. See pages 12–14 for tuner operations.
- 7 COAX:** Lights up when the source signal is a digital signal being input through the COAX terminal.
- 8 OPT:** Lights up when the source signal is a digital signal being input through the OPT terminal.
- 9 DTS:** Lights up when DTS signals are input.
- 10 «LFE»:** Lights up when the disc being played back contains the LFE (Low Frequency Effect) channel and the LFE channel signal is actually being reproduced.



## Enjoying Surround Sound

### Using only the front speakers

In this mode, the receiver outputs the sound from the front L/R speakers only. There is no sound from the sub woofer.

### Listening to 2 channel stereo sources (2CH STEREO)

Standard 2 channel stereo sources completely bypass the sound field processing and multi channel surround formats are downmixed to 2 channel.

**Press 2CH on the remote.**

Or press SOUND FIELD on the system repeatedly. “2CH ST.” appears in the display and the receiver switches to the 2CH STEREO mode.

#### Note

No sound is output from the sub woofer in the 2CH STEREO mode. To listen to the 2 channel stereo sources using the front L/R speakers and a sub woofer, set to “A.F.D. AUTO”.

## Enjoying higher fidelity sound

### — AUTO FORMAT DIRECT

The Auto Format Direct (A.F.D.) mode allows you to select the decoding mode you want for your audio sound.

A.F.D. mode (Display)	Decoding mode
A.F.D. AUTO (A.F.D. AUTO)	As encoded
PRO LOGIC (DOLBY PL)	Dolby Pro Logic
PRO LOGIC II MOVIE (PLII MOV)	Dolby Pro Logic II
PRO LOGIC II MUSIC (PLII MUS)	

### Decoding the input audio signal automatically

In this mode, the receiver automatically detects the type of audio signal being input (Dolby Digital, DTS, standard 2 channel stereo, etc.) and performs the proper decoding if necessary. This mode presents the sound as it was recorded/encoded, without adding any surround effects. However, if there are no low frequency signals (Dolby Digital LFE, etc.) it will generate a low frequency signal for output to the sub woofer.

**Press A.F.D. repeatedly to select “A.F.D. AUTO”.**

Or press SOUND FIELD on the system repeatedly.

The receiver automatically detects the type of audio signal being input and performs the proper decoding if necessary.

### Enjoying stereo sound in multi channel (2 channel decoding mode)

This mode lets you specify the type of decoding for 2 channel audio sources. This receiver can reproduce 2 channel sound in 5 channels

through Dolby Pro Logic II or 4 channels through Dolby Pro Logic.

### **Press A.F.D. repeatedly to select the 2 channel decoding mode.**

Or press SOUND FIELD on the system repeatedly.

#### **■ PRO LOGIC**

Performs Dolby Pro Logic decoding. The source recorded in 2 channel is decoded into 4.1 channels.

#### **■ PRO LOGIC II MOVIE**

Performs Dolby Pro Logic II Movie mode decoding. This setting is ideal for movies encoded in Dolby Surround. In Addition, this mode can reproduce sound in 5.1 channel when watching videos of overdubbed or old movies.

#### **■ PRO LOGIC II MUSIC**

Performs the Dolby Pro Logic II Music mode decoding. This setting is ideal for normal stereo sources such as CDs.

#### **Note**

Dolby Pro Logic and Dolby Pro Logic II decoding do not function for DTS format signals.

### **If you connect a sub woofer**

When the audio signal is 2 channel stereo or if the source signal does not include a LFE signal, the receiver generates a low frequency signal for output to the sub woofer.

## Selecting a sound field

You can take advantage of surround sound simply by selecting one of the receiver's pre-programmed sound fields. They bring the exciting and powerful sound of movie theaters and concert halls into your home.

### **Selecting a sound field for movies**

#### **Press MOVIE repeatedly to select the sound field you want.**

Or press SOUND FIELD on the system repeatedly.

The selected sound field appears in the display.

Sound field	Display
CINEMA STUDIO EX A <b>DCS</b>	C.ST.EX A
CINEMA STUDIO EX B <b>DCS</b>	C.ST.EX B
CINEMA STUDIO EX C <b>DCS</b>	C.ST.EX C

### **About DCS (Digital Cinema Sound)**

Sound fields with **DCS** marks use DCS technology.

DCS is the concept name of the surround technology for home theater developed by Sony. DCS uses the DSP (Digital Signal Processor) technology to reproduce the sound characteristics of an actual cinema cutting studio in Hollywood.

When played at home, DCS will create a powerful theater effect that mimics the artistic combination of sound and action as envisioned by the movie director.

#### **■ C.ST.EX A (CINEMA STUDIO EX A) **DCS****

Reproduces the sound characteristics of the Sony Pictures Entertainment "Cary Grant Theater" cinema production studio. This is a standard mode, great for watching most any type of movies.

#### **■ C.ST.EX B (CINEMA STUDIO EX B) **DCS****

Reproduces the sound characteristics of the Sony Pictures Entertainment "Kim Novak Theater" cinema production studio. This mode is ideal for watching science-fiction or action movies with lots of sound effects.

## ■ C.ST.EX C (CINEMA STUDIO EX C) DCS

Reproduces the sound characteristics of the Sony Pictures Entertainment scoring stage. This mode is ideal for watching musicals or films where orchestra music is featured in the soundtrack.

### About CINEMA STUDIO EX modes



CINEMA STUDIO EX modes are suitable for watching motion picture DVDs (etc.), with multi channel surround effects. You can reproduce the sound characteristics of Sony Pictures Entertainment's dubbing studio in your home.

The CINEMA STUDIO EX modes consist of the following three elements.

- Virtual Multi Dimension  
Creates 5 sets of virtual speakers from a single pair of actual surround speakers.
- Screen Depth Matching  
Creates the sensation that the sound is coming from inside the screen like in theaters.
- Cinema Studio Reverberation  
Reproduces the type of reverberation found in theaters.

The CINEMA STUDIO EX modes integrate these three elements simultaneously.

### Tips

- The receiver memorizes the last sound field selected for each program source (Sound Field Link). Whenever you select a program source, the sound field that was last applied is automatically applied again. For example, if you listen to DVD with HALL as the sound field, change to a different program source, then return to DVD, HALL will be applied again.
- You can identify the encoding format of DVD software, etc. by looking at the logo on the package.
  -  : Dolby Digital discs
  -  : Dolby Surround encoded programs
  -  : DTS Digital Surround encoded programs

### Notes

- The effects provided by the virtual speakers may cause increased noise in the playback signal.
- When listening with sound fields that employ the virtual speakers, you will not be able to hear any sound coming directly from the surround speakers.

## Selecting a sound field for music

Press **MUSIC** repeatedly to select the sound field you want.

Or press **SOUND FIELD** on the system repeatedly.

The selected sound field appears in the display.

Sound field	Display
HALL	HALL
JAZZ CLUB	JAZZ
LIVE CONCERT	CONCERT

### ■ HALL

Reproduces the acoustics of a classical concert hall.

### ■ JAZZ (JAZZ CLUB)

Reproduces the acoustics of a jazz club.

### ■ CONCERT (LIVE CONCERT)

Reproduces the acoustics of a 300-seat live house.

## To turn off the surround effect

Press **2CH** or **A.F.D.**

## Switching the audio input mode for digital components

### — INPUT MODE

You can switch the audio input mode for components for which this receiver has digital audio input jacks.

- 1** Press **INPUT SELECTOR** to select the input.
- 2** Press **INPUT MODE** repeatedly to select the audio input mode.

The selected audio input mode appears in the display.

### Audio input modes

- **AUTO IN**  
Gives priority to the digital audio signals, and specifies analog audio signals input to the **AUDIO IN (L/R)** jacks when there is no digital audio signals.
- **COAX IN**  
Specifies the digital audio signals input to the **DIGITAL COAXIAL** input jack.
- **OPT IN**  
Specifies the digital audio signals input to the **DIGITAL OPTICAL** input jacks.
- **ANALOG**  
Specifies the analog audio signals input to the **AUDIO IN (L/R)** jacks.

## Selecting the digital audio input decoding priority

Lets you specify the input mode for the digital signal input to the digital input jacks.

- 1** Press **MAIN MENU** repeatedly to select the **SET UP** menu.
- 2** Press **↑/↓** to select to select “**DEC. XXXX**”.
- 3** Press **←/→** to select the setting you want.

### Digital audio input decoding priority

- **AUTO**  
Automatically switches the input mode between **DTS**, **Dolby Digital**, or **PCM**.
- **PCM**  
PCM signals are given priority (to prevent the interruption when playback starts). Even when other signals are input, the sound is output. When set to “**AUTO**” and the sound from the digital audio jacks (for **CD**, etc.) is interrupted when playback starts, set to “**PCM**”.

## Using the Sleep Timer

You can set the receiver to turn off automatically at a specified time by using the remote.

- 1** Press **MAIN MENU** repeatedly to select the **SET UP** menu.
- 2** Press **▲/▼** until **“SLEEP”** and **“OFF”** indication in the display flashes.
- 3** Press **←/→** to select the time.

The display changes cyclically as follows:

2:00:00 ↔ 1:30:00 ↔ 1:00:00 ↔

0:30:00 ↔ OFF ↔ 2:00:00 ...

While using Sleep Timer, **“SLEEP”** lights up in the display.

### Tip

To check the remaining time before the receiver turns off, perform step 1 and 2 above. The remaining time appears in the display.

## Using the supplied remote to controlling the other component

You can use the supplied remote to control other Sony components.

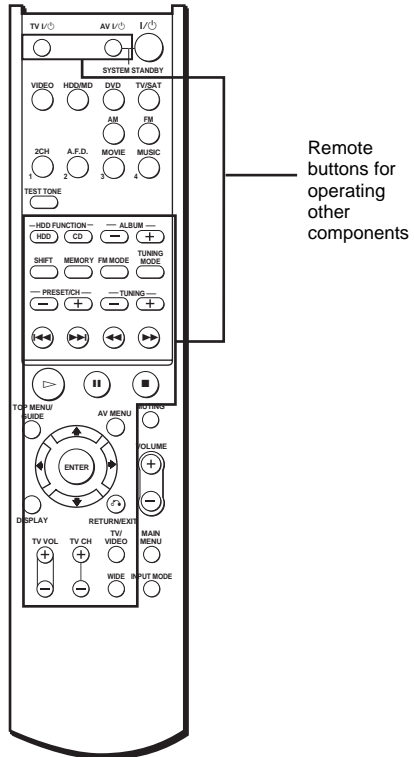

Remote Button	Operations	Function
ALBUM +/-	Hard disc audio recorder/CD player	Selects the MP3 album.
AV I/⏻	TV/VCR/Hard disc audio recorder/CD player/VCD player/DVD player/MD deck	Turns the audio and video components on or off.
AV MENU	VCR/Satellite tuner/DVD player	Displays menu.
DISPLAY	TV/VCR/VCD player/DVD player	Selects information displayed on the TV screen.
ENTER	VCR/Satellite tuner/DVD player	After selecting a menu item, press to enter the selection.
FM MODE	Tuner	Selects FM monaural or stereo reception.
HDD FUNCTION HDD CD	HDD	Switches the function of HDD.
MEMORY	Tuner	Stores the radio stations.
PRESET/CH +/-	Tuner	Scans and selects preset stations.
	TV/VCR/Satellite tuner	Selects preset channels.
>RETURN	VCD player/DVD player	Returns to the previous menu.
⏻/EXIT	Satellite tuner	Exits the menu.
SHIFT	Tuner	Press repeatedly to select a memory page for presetting radio stations or tuning to preset stations.
SYSTEM STANDBY (Press AV I/⏻ while holding down I/⏻)	Control center/TV/VCR/Satellite tuner/Hard disc audio recorder/CD player/VCD player/DVD player/MD deck/Tape deck	Turns off the system and other Sony audio/video components.

Remote Button	Operations	Function
TOP	DVD player	Displays DVD title.
MENU/GUIDE	Satellite tuner	Displays guide menu.
TUNING +/-	Tuner	Scans radio stations.
-		
TUNING MODE	Tuner	Switches the tuning mode.
TV I/⏻	TV	Turns the TV on or off.
TV/VIDEO	TV	Selects input signal: TV input or video input.
TV CH +/-	TV	Select preset TV channels.
TV VOL +/-	TV	Adjusts the volume of the TV.
WIDE	TV	Selects the wide-picture mode (only for Sony TVs that support wide-picture mode).
▷	VCR/Hard disc audio recorder/CD player/VCD player/DVD player/MD deck/Tape deck	Starts play.
⏸	VCR/Hard disc audio recorder/CD player/VCD player/DVD player/MD deck/Tape deck	Pauses play or record. (Also starts recording with components in record standby.)
■	VCR/Hard disc audio recorder/CD player/VCD player/DVD player/MD deck/Tape deck	Stops play.

Remote Button	Operations	Function
◀◀/▶▶	VCR/Hard disc audio recorder/ CD player/ VCD player/ DVD player/ MD deck/ Tape deck	Skips tracks.
◀◀/▶▶	Hard disc audio recorder/ CD player/ VCD player/ DVD player/ MD deck	Searches tracks (forward or backward).
	VCR/ Tape deck	Fast forwards or rewinds.
▲/◆/◀/▶	VCR/Satellite tuner/DVD player	Selects a menu item.

### Notes

- The above explanation is intended to serve as an example only. Therefore, depending on the component the above operation may not be possible or may operate differently than described.
- Before you use the ▲/◆/◀/▶ button for receiver operation, press MAIN MENU. To operate other components, press TOP MENU/GUIDE or AV MENU after pressing the input button.

## Changing the factory setting of a input button on the remote

If the factory settings of the input buttons on the remote do not match your system components, you can change them. For example, if you have a tape deck and you do not have an MD deck, you can assign the HDD/MD button to your tape deck.

**While pressing one of the input buttons on the remote (VIDEO/HDD/MD/DVD/TV/SAT/AM/FM) you want to assign the component, press two numeric buttons, then release the input button.**

Example: Press HDD/MD, 2, 4, then release HDD/MD.

For the assignable components and buttons to be pressed, refer to the table below.

To operate	Buttons		
	While pressing	Press first	Press second
VCR (command mode VTR 3*)	VIDEO	1	3
VCR (command mode VTR 2*)	VIDEO	1	4
Hard disc audio recorder / CD player	HDD/MD	2	2
MD deck	HDD/MD	2	3
Tape deck A	HDD/MD	2	4
Tape deck B	HDD/MD	3	1
DVD player	DVD	3	2
VCD player	DVD	3	3
TV	TV/SAT	3	4
DSS (Digital Satellite Receiver)	TV/SAT	4	1
Receiver (AM)	AM	1	1
Tuner (AM)	AM	1	2
Receiver (FM)	FM	2	1
Tuner (FM)	FM	1	2

\* Sony VCRs are operated with a VTR 2 or 3 setting. These correspond to 8mm and VHS respectively.

continued

## To reset all the input buttons to their factory setting

Press I/⏻, AV I/⏻ and VOLUME – at the same time.

## Setting up the speakers

You can use the SET UP menu to set the size and distance of the speakers connected to this system.

- 1 Press I/⏻ to turn on the system.**
- 2 Press MAIN MENU repeatedly to select the SET UP menu.**
- 3 Press ↑/↓ to select the menu item you want.**  
For more information, see “Speaker setup parameters”.
- 4 Press ←/→ to select the parameter.**
- 5 Repeat steps 3 and 4 until you have set all of the items that follow.**

---

### Speaker setup parameters

The initial settings are underlined.

#### ■ (SUB WOOFER) (Sub woofer)

- YES

If you connect a sub woofer, select “YES”.

- NO

If you did not connect a sub woofer, select “NO”.

This activates the bass redirection circuitry and outputs the LFE signals from other speakers.

#### ■ (FRONT) (Front speakers)

- LARGE

If you connect large speakers that will effectively reproduce bass frequencies, select “LARGE”.

Normally, select “LARGE”.

- SMALL

If the sound is distorted, or you feel a lack of surround effects when using multi channel surround sound, select “SMALL” to activate the bass redirection circuitry and output the front channel bass frequencies from the sub woofer. When the front speakers are set to “SMALL”, the center, and surround speakers are also automatically set to “SMALL” (unless previously set to “NO”).

#### ■ (CENTER) (Center speaker)

- LARGE

If you connect a large speaker that will effectively reproduce bass frequencies, select “LARGE”.

Normally, select “LARGE”. However, if the front speakers are set to “SMALL”, you cannot set the center speaker to “LARGE”.



- **SMALL**

If the sound is distorted, or you feel a lack of surround effects when using multi channel surround sound, select “SMALL” to activate the bass redirection circuitry and output the center channel bass frequencies from the front speakers (if set to “LARGE”) or sub woofer.

- **NO**

If you did not connect a center speaker, select “NO”. The sound of the center channel will be output from the front speakers.

-   **(SURROUND) (Surround speakers)**

- **LARGE**

If you connect large speakers that will effectively reproduce bass frequencies, select “LARGE”. Normally, select “LARGE”. However, if the front speakers are set to “SMALL”, you cannot set the surround speakers to “LARGE”.

- **SMALL**

If the sound is distorted, or you feel a lack of surround effects when using multi channel surround sound, select “SMALL” to activate the bass redirection circuitry and output the surround channel bass frequencies from the sub woofer or other “LARGE” speakers.

- **NO**

If you did not connect surround speakers, select “NO”.

**Tip**

The “LARGE” and “SMALL” settings for each speaker determine whether or not the internal sound processor will cut the bass signal from that channel. When the bass is cut from a channel, the bass redirection circuitry sends the corresponding bass frequencies to the sub woofer or other “LARGE” speakers.

However, it is best not to cut them, if possible. Therefore, even when using small speakers, you can set them to “LARGE” if you want to output the bass frequencies from that speaker. On the other hand, if you are using a large speaker, but prefer not to have bass frequencies output from that speaker, set it to “SMALL”.

If the overall sound level is lower than you prefer, set all speakers to “LARGE”. If there is not enough bass, you can use the equalizer to boost the bass levels. To adjust the bass, see page 26.

-   **DIST. X.X m (Front speaker distance)**

Initial setting: 3.0 m

Lets you set the distance from your listening position to the front speakers (**A** on page 8). You can adjust from 1.0 meter to 7.0 meters in 0.1 meter steps.

If both front speakers are not placed an equal distance from your listening position, set the distance to the closest speaker.

-   **DIST. X.X m (Center speaker distance)**

Initial setting: 3.0 m

Lets you set the distance from your listening position to the center speaker. You can adjust from 1.0 meter to 7.0 meters in 0.1 meter steps.

-   **DIST. X.X m (Surround speaker distance)**

Initial setting: 3.0 m

Lets you set the distance from your listening position to the surround speakers. You can adjust from 1.0 meter to 7.0 meters in 0.1 meter steps.

If both surround speakers are not placed an equal distance from your listening position, set the distance to the closest speaker.

-   **PL. (Surround speaker placement)\***

Lets you specify the height of your surround speakers for proper implementation of the surround effects in the Cinema Studio EX modes (page 18).

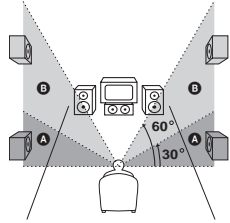

- **LOW**

Select if the height of your surround speakers corresponds to section **A**.

- **HIGH**

Select if the height of your surround speakers corresponds to section **B**.

\* This setup item is not available when the surround speaker parameter is set to “NO”.

# Customizing sound fields

By adjusting the LEVEL menu and TONE menu, you can customize the sound fields to suit your particular listening situation.

Position your speakers and do the procedures described in “Placing speakers” (page 8) and “Checking the connections” (page 11) before you customize a sound field.

## Adjusting the LEVEL menu

You can adjust the balance and level of each speaker. These settings are applied to all sound fields. (Except for the EFCT. parameter. The setting of the EFCT. parameter is stored for each sound field independently.)

- 1 Start playing a source encoded with multi channel surround effects (DVD, etc.).**
- 2 Press MAIN MENU repeatedly to select the LEVEL menu.**
- 3 Press  $\uparrow/\downarrow$  to select the parameter.**  
For details, see “LEVEL menu parameters” below.
- 4 While monitoring the sound, press  $\leftarrow/\rightarrow$  to adjust the selected parameter.**
- 5 Repeat steps 3 and 4 to adjust the other parameters.**

### LEVEL menu parameters

#### **BAL. XXX (Front speaker balance)**

Initial setting: BALANCE

Lets you adjust the balance between front left and right speakers. You can adjust in the range of L (+1 to +8), BALANCE (0), R (+1 to +8) in 17 steps.

#### **CTR XXX dB (Center speaker level)**

#### **SUR.L. XXX dB (Surround speaker (L) level)**

#### **SUR.R. XXX dB (Surround speaker (R) level)**

#### **S.W. XXX dB (Sub woofer level)**

Initial setting: 0 dB

You can adjust from -10 dB to +10 dB in 1 dB steps.

#### **COMP. (Dynamic range compressor)**

Lets you compress the dynamic range of the sound track. This may be useful when you want to watch movies at low volumes late at night.

- **OFF**  
The dynamic range is not compressed.
- **STD**  
The dynamic range is compressed as intended by the recording engineer.
- **MAX**  
The dynamic range is compressed dramatically.

#### **Tip**

Dynamic range compressor lets you compress the dynamic range of the soundtrack based on the dynamic range information included in the Dolby Digital signal. “STD” is the initial setting, but it only enacts light compression.

Therefore, we recommend using the “MAX” setting. This greatly compresses the dynamic range and lets you view movies late at night at low volumes. Unlike analog limiters, the levels are predetermined and provide a very natural compression.

#### **Note**

Dynamic range compression is possible with Dolby Digital sources only.

#### **EFCT. XXX (Effect level)**

Lets you adjust the size of the current surround effect. This parameter is displayed only when “C.ST.EX A”, “C.ST.EX B”, “C.ST.EX C”, “CONCERT”, “JAZZ”, or “HALL” is selected.

- **MIN**  
The surround effect decreases.
- **STD**  
Normal surround effect is applied.
- **MAX**  
The surround effect increases.

## Adjusting the TONE menu

You can adjust the tonal quality (bass, treble level) of each speaker using the TONE menu.

- 1 Start playing a source encoded with multi channel surround effects (DVD, etc.).**
- 2 Press MAIN MENU repeatedly to select the TONE menu.**
- 3 Press  $\uparrow/\downarrow$  to select the parameter.**

For details, see “TONE menu parameters” below.

- 4** While monitoring the sound, press **←/→** to adjust the selected parameter.
- 5** Repeat steps 3 and 4 to adjust the other items.

### **TONE menu parameters**

■ **BASS XXX dB**  
(Front speaker bass level)

■ **TREB. XXX dB**  
(Front speaker treble level)

Initial setting: 0 dB

You can adjust from -6 dB to +6 dB in 1 dB steps.

## Additional Information

### Precautions

#### On safety

Should any solid object or liquid fall into the cabinet, unplug the receiver and have it checked by qualified personnel before operating it any further.

#### On power sources

- Before operating the unit, check that the operating voltage is identical with your local power supply. The operating voltage is indicated on the nameplate at the rear of the receiver.
- The unit is not disconnected from the AC power source (mains) as long as it is connected to the wall outlet, even if the unit itself has been turned off.
- If you are not going to use the receiver for a long time, be sure to disconnect the receiver from the wall outlet. To disconnect the AC power cord, grasp the plug itself; never pull the cord.
- AC power cord must be changed only at the qualified service shop.

#### On heat buildup

Although the unit heats up during operation, this is not a malfunction. Besides, it is not a malfunction that the upper left corner of the unit heats up while the power is on. If you continuously use this unit at a large volume, the cabinet temperature of the top, side and bottom rises considerably. To avoid burning yourself, do not touch the cabinet.

#### On placement

- Place the receiver in a location with adequate ventilation to prevent heat buildup and prolong the life of the receiver.
- Do not place the receiver near heat sources, or in a place subject to direct sunlight, excessive dust or mechanical shock.
- Do not place anything on top of the cabinet that might block the ventilation holes and cause malfunctions.
- Use caution when placing the unit or speakers on surfaces that have been specially treated (with wax, oil, polish, etc.) as staining or discoloration of the surface may result.

#### On operation

Before connecting other components, be sure to turn off and unplug the receiver.

#### On cleaning

Clean the cabinet, panel and controls with a soft cloth slightly moistened with a mild detergent solution. Do not use any type of abrasive pad, scouring powder or solvent such as alcohol or benzene.

If you have any question or problem concerning your receiver, please consult your nearest Sony dealer.

# Troubleshooting

If you experience any of the following difficulties while using the receiver, use this troubleshooting guide to help you remedy the problem. Should any problem persist, consult your nearest Sony dealer.

---

## **There is no sound no matter which component is selected.**

- Check that both the receiver and all components are turned on.
- Check that the VOLUME control is not set at “MIN”.
- Check that all speaker cords are connected correctly.
- Press MUTE on the remote to cancel the muting function.

---

## **There is no sound from a specific component.**

- Check that the component is connected correctly to the audio input jacks for that component.
- Check that the cord(s) used for the connection is (are) fully inserted into the jacks on both the receiver and the component.

---

## **There is no sound from one of the front speakers.**

- Connect a pair of headphones to the PHONES jack to verify that sound is output from the headphones. If only one channel is output from the headphones, the component may not be connected to the receiver correctly. Check that all the cords are fully inserted into the jacks on both the receiver and the component. If both channels are output from the headphones, the front speaker may not be connected to the receiver correctly. Check the connection of the front speaker which is not outputting any sound.

---

## **The multi channel surround effect of the Dolby Digital or DTS is not obtained.**

- Check that the DVD software, etc. is recorded in Dolby Digital or DTS.
- If you connect the DVD player, etc. to the digital input jack on this system, check the audio setting (for digital audio output) of the component.
- Check that the audio track is correctly selected on the DVD player. (Check the audio setting of the DVD menu.)

---

## **There is no sound or only a very low-level sound is heard.**

- Check that the speakers and components are connected securely.

- Check that you have selected the correct component on the receiver.
- Check that the headphones are not connected.
- Press MUTE on the remote to cancel the muting function.
- The protection circuit has been activated. Turn off the receiver, eliminate the short-circuit problem and turn on the power again after about 20 seconds.

---

## **The left and right sounds are unbalanced or reversed.**

- Check that the speakers and components are connected correctly and securely.
- Adjust balance parameters in the LEVEL menu.

---

## **There is severe hum or noise.**

- Check that the speakers and components are connected securely.
- Check that the connecting cords are away from a transformer or motor, and at least 3 meters away from a TV set or fluorescent light.
- The plugs and jacks are dirty. Wipe them with a cloth slightly moistened with alcohol.

---

## **There is no sound from the center speaker.**

- Make sure the sound field function is on (press SOUND FIELD).
- Select the CINEMA STUDIO EX mode (page 18).
- Adjust the speaker level (page 11).
- Make sure the center speaker is set to either “SMALL” or “LARGE” (page 24).

---

## **There is no sound or only a very low-level sound is heard from the surround speakers.**

- Make sure the sound field function is on (press SOUND FIELD).
- Select the CINEMA STUDIO EX mode (page 18).
- Adjust the speaker level (page 11).
- Make sure the surround speakers are set to either “SMALL” or “LARGE” (page 25).

---

## **There is no sound from the active sub woofer.**

- Check that “2CH ST.” is not selected (page 17).

---

## **The surround effect cannot be obtained.**

- Make sure the sound field function is on (press A.F.D., MOVIE or MUSIC).
- Sound fields do not function for the signals with a sampling frequency of more than 48 kHz.

---

### Radio stations cannot be tuned in.

- Check that the antennas are connected securely. Adjust the antennas and connect an external antenna if necessary.
- The signal strength of the stations is too weak (when tuning in with automatic tuning). Use direct tuning.
- Make sure you set the tuning interval correctly (when tuning in AM stations with direct tuning).
- No stations have been preset or the preset stations have been cleared (when tuning by scanning preset stations). Preset the stations (page 13).
- Press DISPLAY so that the frequency appears in the display.

---

### RDS does not work.

- Make sure that you're tuned to an FM RDS station.
- Select a stronger FM station.

---

### The RDS information that you want does not appear.

- Contact the radio station and find out whether or not they actually provide the service in question. If so, the service may be temporarily out of order.

---

### There is no picture or an unclear picture appears on the TV screen or monitor.

- Select the appropriate input on the receiver.
- Set your TV to the appropriate input mode.

---

## Remote control

---

### The remote does not function.

- Point the remote at the remote sensor  on the receiver.
- Remove any obstacles in the path between the remote and the receiver.
- Replace all the batteries in the remote with new ones, if they are weak.
- Make sure you select the correct input on the remote.

---

## Reference sections for clearing the memory

To clear	See
All memorized settings	page 10

# Specifications

## Amplifier section

### POWER OUTPUT

Rated Power Output at Stereo Mode

(8 ohms 1 kHz, DIN) 50 W + 50 W

Reference Power Output

(4 ohms 1 kHz, DIN) FRONT<sup>1)</sup>: 75 W + 75 W

CENTER<sup>1)</sup>: 75 W

SURROUND<sup>1)</sup>:

75 W + 75 W

1) Depending on the sound field settings and the source, there may be no sound output.

Frequency response 20 Hz – 20 kHz

Inputs (Analog) Sensitivity: 500 mV

Impedance: 50 kilohms

S/N<sup>2)</sup>: 84 dB

(A, 500 mV<sup>3)</sup>)

2) INPUT SHORT.

3) Weighted network, input level.

Inputs (Digital)

---

DVD (Coaxial) Impedance: 75 ohms

S/N: 90 dB

(A, 20 kHz LPF)

---

DVD, TV/SAT, S/N: 90 dB

HDD/MD (Optical) (A, 20 kHz LPF)

---

Sampling frequency

COAX, OPT 96 kHz

Outputs

LINE (sub woofer) Voltage: 2 V

Impedance: 1 kilohms

## FM tuner section

Tuning range 87.5 - 108.0 MHz

Antenna terminals 75 ohms, unbalanced

Intermediate frequency 10.7 MHz

Sensitivity

Mono: 18.3 dBf, 2.2  $\mu$ V/75 ohms

Stereo: 38.3 dBf, 22.5  $\mu$ V/75 ohms

Useable sensitivity 11.2 dBf, 1  $\mu$ V/75 ohms

S/N

Mono: 76 dB

Stereo: 70 dB

Harmonic distortion at 1 kHz

Mono: 0.3%

Stereo: 0.5%

Separation 45 dB at 1 kHz

Frequency response 30 Hz – 15 kHz,

+0.5/-2 dB

Selectivity 60 dB at 400 kHz

**AM tuner section**

Tuning range	531 – 1,602 kHz
Antenna	Loop antenna
Intermediate frequency	450 kHz
Usable sensitivity	50 dB/m (at 999 kHz)
S/N	54 dB (at 50 mV/m)
Harmonic distortion	0.5% (50 mV/m, 400 Hz)
Selectivity	
At 9 kHz:	35 dB

**General**

Power requirements	230 V AC, 50/60 Hz
Power consumption	95 W
Power consumption (during standby mode)	0.7 W
Dimensions	430 × 65 × 288 mm including projecting parts and controls
Mass (Approx.)	2.7 kg

**Supplied accessories**

- FM wire antenna (1)
- AM loop antenna (1)
- Remote commander (1)
- R6 (size-AA) batteries (2)
- Speaker plug (5)
- Wrench (1)

Design and specifications are subject to change without notice.

# List of button locations and reference pages

## How to use this page

Use this page to find the location of buttons and other parts of the system that are mentioned in the text.

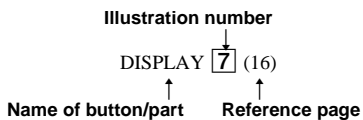

## Main unit

### ALPHABETICAL ORDER

Display **2**

INPUT SELECTOR **3** (12, 13, 20)

MUTING **6** (12)

PHONES jack **8**

PRESET TUNING +/- **4** (13)

SOUND FIELD **7** (17, 18, 19, 29)

VOLUME **5** (11, 12)

### SYMBOLS

I/⏻ (power) **1**

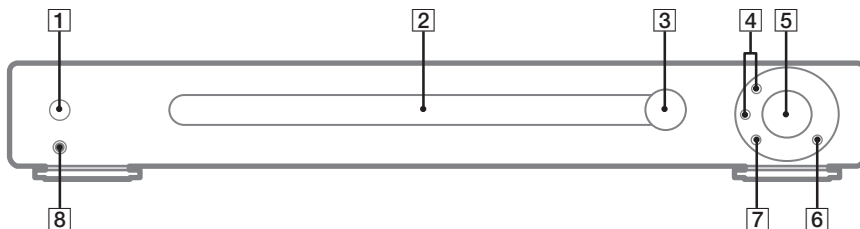



# Remote control

## ALPHABETICAL ORDER

### A - M

- A.F.D. **40** (17, 18, 19)
- ALBUM +/- **6**
- AM **21** (12, 13)
- AV I/⏻ (power) **2** (24)
- AV MENU **29** (23)
- DISPLAY **34** (14, 30)
- DVD **4**
- ENTER **35**
- FM **5** (12, 13)
- FM MODE **28** (13)
- HDD FUNCTION **20**
- HDD/MD **23**
- INPUT MODE **33** (20)
- MAIN MENU **32** (11, 20, 21, 24, 26)
- MEMORY **37** (13)
- MOVIE **26** (18)
- MUSIC **25** (19)
- MUTING **10** (12, 29)

### P - T

- PRESET/CH +/- **19** (13)
- RETURN ⏪/EXIT **31**
- SHIFT **38** (13)
- TEST TONE **39** (11)
- TOP MENU/GUIDE **36** (23)
- TUNING +/- **7** (12, 13)
- TUNING MODE **27** (12)
- TV/SAT **3**
- TV CH +/- **14**
- TV VOL +/- **15**
- TV/VIDEO **12**
- TV I/⏻ (power) **24**

### V - W

- VIDEO **22**
- VOLUME +/- **11** (11, 24, 29)
- WIDE **13**

## NUMBERS AND SYMBOLS

- I/⏻ (power) **1**
- ⏪/⏩/⏪/⏩ **30** (11, 20, 21, 24, 26)
- ◀▶▶▶ **8**
- ▶▶▶▶ **18**
- ▶ **17**
- ⏏ **16**
- **9**
- 2CH **41** (17, 19)

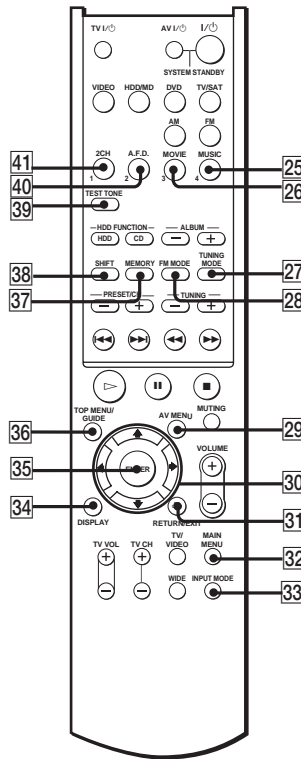
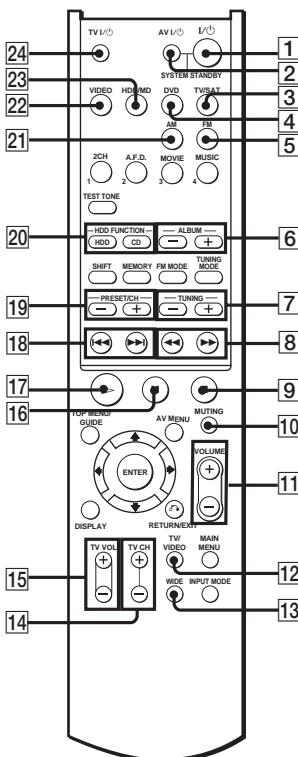

# Index

## A

- Adjusting
  - LEVEL parameter 26
  - SET UP parameters 24
  - Speaker volume 11
  - TONE menu 26
- Automatic tuning 12

## C

- Clearing receiver's memory 10

## D

- Digital Cinema Sound 18

## L

- LEVEL menu 26

## M

- Manual tuning 12

## P

- Preset tuning 13

## R

- RDS 14

## S

- Selecting
  - Component 12
  - Sound field 18–19
- SET UP menu 24
- Sleep Timer 21
- Sound field
  - Customizing 26
  - Pre-programmed 18–19
  - Selecting 18–19
- Speakers
  - Adjusting speaker volume 11
  - Connection 9
  - Placement 8
- Supplied accessories 31

## T

- Test tone 11
- TONE menu 26
- Tuning
  - Automatically 12
  - Manually 12
  - Preset stations 13



