

Micro Hi-Fi Component System

Operating Instructions

Owner's Record

The model and serial numbers are located on the bottom of the unit. Record the serial number in the space provided below. Refer to them whenever you call upon your Sony dealer regarding this product.

Model No. _____ Serial No. _____



***CMT-EP303
CMT-EP305***

WARNING

To prevent fire or shock hazard, do not expose the unit to rain or moisture.

To avoid electrical shock, do not open the cabinet. Refer servicing to qualified personnel only.

Do not install the appliance in a confined space, such as a bookcase or built-in cabinet.

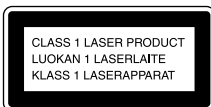

This appliance is classified as a CLASS 1 LASER product. This label is located on the bottom.

To prevent fire, do not cover the ventilation of the apparatus with newspapers, table-cloths, curtains, etc. And don't place lighted candles on the apparatus.

To prevent fire or shock hazard, do not place objects filled with liquids, such as vases, on the apparatus.



Don't throw away the battery with general house waste, dispose of it correctly as chemical waste.

NOTICE FOR THE CUSTOMERS IN THE U.S.A.

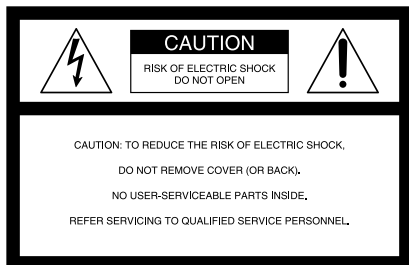

This symbol is intended to alert the user to the presence of uninsulated "dangerous voltage" within the product's enclosure that may be of sufficient magnitude to constitute a risk of electric shock to persons.



This symbol is intended to alert the user to the presence of important operating and maintenance (servicing) instructions in the literature accompanying the appliance.

CAUTION

The use of optical instruments with this product will increase eye hazard.

WARNING

This equipment has been tested and found to comply with the limits for a Class B digital device, pursuant to Part 15 of the FCC Rules. These limits are designed to provide reasonable protection against harmful interference in a residential installation. This equipment generates, uses, and can radiate radio frequency energy and, if not installed and used in accordance with the instructions, may cause harmful interference to radio communications. However, there is no guarantee that interference will not occur in a particular installation. If this equipment does cause harmful interference to radio or television reception, which can be determined by turning the equipment off and on, the user is encouraged to try to correct the interference by one or more of the following measures:

- Reorient or relocate the receiving antenna.
- Increase the separation between the equipment and receiver.
- Connect the equipment into an outlet on a circuit different from that to which the receiver is connected.
- Consult the dealer or an experienced radio/TV technician for help.

CAUTION

You are cautioned that any changes or modifications not expressly approved in this manual could void your authority to operate this equipment.

Note to CATV system installer:

This reminder is provided to call the CATV system installer's attention to Article 820-40 of the NEC that provides guidelines for proper grounding and, in particular, specifies that the cable ground shall be connected to the grounding system of the building, as close to the point of cable entry as practical.

NOTICE FOR THE CUSTOMERS IN CANADA

CAUTION

TO PREVENT ELECTRIC SHOCK, DO NOT USE THIS POLARIZED AC PLUG WITH AN EXTENSION CORD, RECEPTACLE OR OTHER OUTLET UNLESS THE BLADES CAN BE FULLY INSERTED TO PREVENT BLADE EXPOSURE.

Table of Contents

List of Button Locations and Reference Pages

Main unit	4
Remote control	5

Getting Started

Hooking up the system	6
Inserting two size AA (R6) batteries into the remote	7
Setting the clock	7

CD

Loading the CD	8
Playing the CD	
— Normal Play/Shuffle Play/Repeat Play	8
Programing the CD tracks	
— Program Play	9

Tuner

Presetting radio stations	10
Listening to the radio	
— Preset Tuning	11
— Manual Tuning	11

Tape

Loading a tape	12
Playing a tape	12
Recording to a tape	
— CD Synchro Recording/Recording	
Manually	13

Sound Adjustment

Adjusting the sound	
— MEGA BASS	14
Turning off the sound	
— Muting	14

Timer

Falling asleep to music	
— Sleep Timer	14
Waking up to music	
— Daily Timer	15

Display

Using the CD display	16
----------------------------	----

Troubleshooting

Problems and remedies	16
-----------------------------	----

Additional information

Precautions	18
Specifications	19

How to use this page

Use this page to find the location of buttons and other parts of the system that are mentioned in the text.

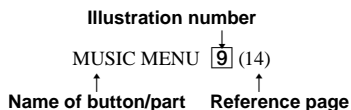

Main unit

ALPHABETICAL ORDER

A - P

- Cassette compartment 13 (12)
- CD 4 (8, 9, 13)
- Display Window 5 (8, 9, 10)
- ENTER/PGM 20 (8, 9, 10, 14)
- MEGA BASS 8 (14)
- MUSIC MENU 9 (14)
- PHONES jack 22
- PRESET +/- 12 (10, 11)

R - Z

- Remote sensor 10
- REPEAT 2 (8)
- SHUFFLE 21 (8)
- TAPE 3 (12)
- TIMER indicator 1 (15)
- TUNER 6 (10, 11, 13)
- TUNER MEM 20 (10)
- TUNING +/- 23 (10, 11)
- VOLUME control 11

BUTTON DESCRIPTIONS

I/⏻ (power) 26 (6)

CD

⏮ ⏪ ⏩ ⏭ (go back/go forward) 23 (8, 9)

⏸ (play/pause) 24 (8, 9)

⏏ PUSH OPEN/CLOSE 7 (8)

■ (stop) 25 (8, 9)

TAPE

⏭ (fast forward) 16 (12)

⏸ (pause) 14 (12, 13)

▶ (play) 18 (12)

● (recording) 19 (13)

⏮ (rewind) 17 (12)

■▲ (stop/eject) 15 (12, 13)

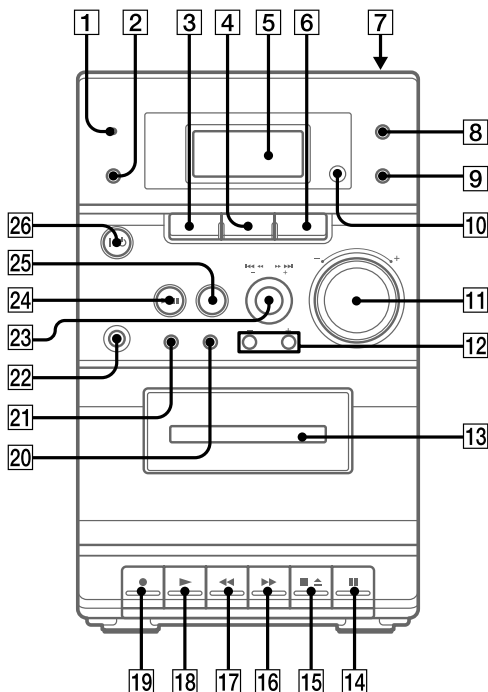

Remote control

ALPHABETICAL ORDER

A - P

- CD/REMAIN **19** (7, 8, 9, 13, 15, 16)
- CLOCK/TIMER + **8** (7, 14, 15)
- CLOCK/TIMER - **13** (7, 14, 15)
- CLOCK/TIMER/SLEEP SET **1** (7, 14, 15)
- MEGA BASS **12** (14)
- MUSIC MENU **11** (14)
- MUTING **10** (14)
- PRESET +/- **14** (10, 11)

R - Z

- REPEAT **6** (8)
- SHUFFLE **5** (8)
- TAPE **18** (12)
- TIMER ON/OFF **2** (15)
- TUNER/BAND **4** (10, 11, 13)
- TUNER MEM/ENTER/PGM **7** (7, 9, 10, 14, 15)
- TUNING + **8** (10, 11)
- TUNING - **13** (10, 11)
- VOL (volume) +/- **9**

BUTTON DESCRIPTIONS

- ◀◀ (rewind) ▶▶ (fast forward) **15** (8)
- ◀◀ (go back) ▶▶ (go forward) **15** (8, 9)
- ▶|| (play/pause) **16** (8, 9)
- ⏻ (power) **3** (6)
- (stop) **17** (8, 9, 12)

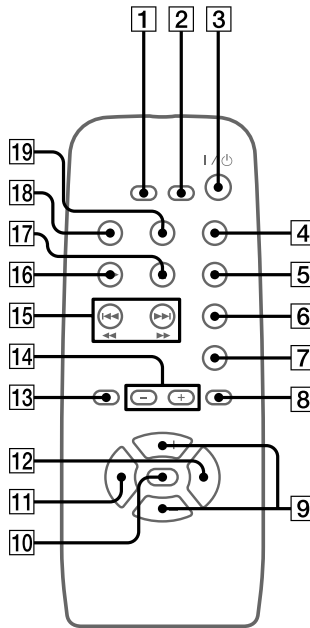

Hooking up the system

Do the following procedure **1** to **2** to hook up your system using the supplied cords and accessories.

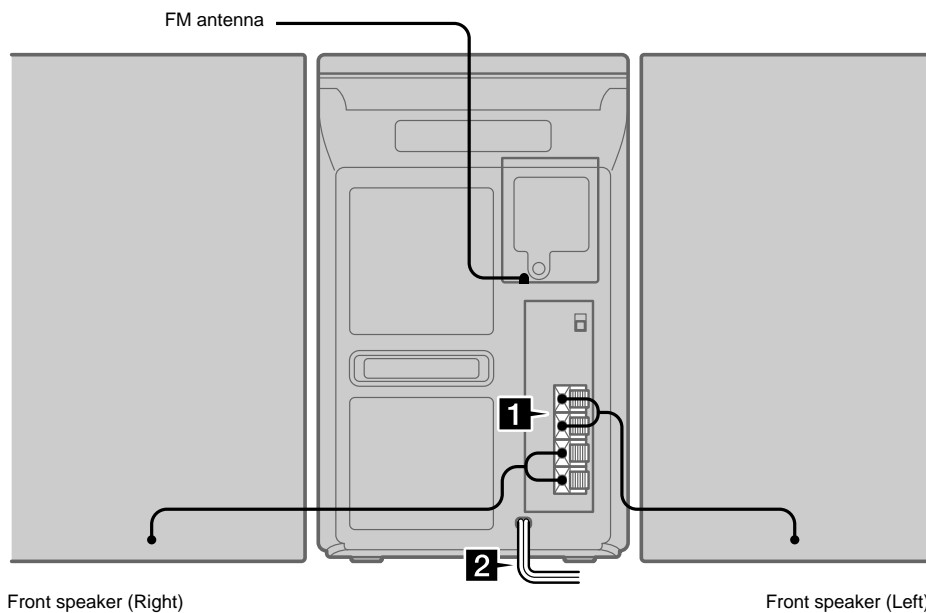

1 Connect the front speakers.

Connect the speaker cords to the SPEAKER terminals as shown below.

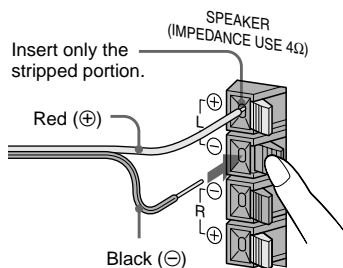

2 Connect the power cord to a wall outlet.

If the supplied adaptor on the plug does not fit your wall outlet, detach it from the plug (only for models equipped with the adaptor).

To turn on the system, press **I** / **⏻** (power).

Inserting two size AA (R6) batteries into the remote

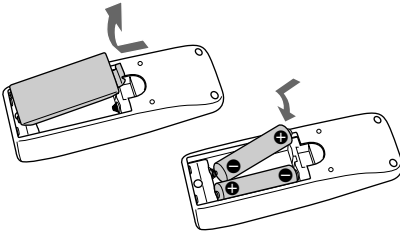

Tip

When the remote no longer operates the system, replace both batteries with new ones.

Note

If you do not use the remote for a long period of time, remove the batteries to avoid possible damage from battery leakage.

Setting the clock

- 1** Turn on the system.
- 2** Press **CLOCK/TIMER/SLEEP SET** on the remote.
- 3** Press **CLOCK/TIMER +** or **-** on the remote repeatedly to set the clock.
- 4** Press **TUNER MEM/ENTER/PGM** on the remote.

The clock starts working.

To adjust the clock

Perform from step 2.

Note

The clock settings are canceled when you disconnect the power cord or if a power failure occurs.

Loading the CD

- 1 Press **▲** PUSH OPEN/CLOSE down to open the lid of the CD compartment.
- 2 Place a CD with the label side up on the compartment.

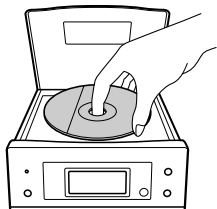

- 3 Press **▲** PUSH OPEN/CLOSE down to close the lid of the CD compartment.

Playing the CD

— Normal Play/Shuffle Play/Repeat Play

This system lets you play the CD in different play modes.

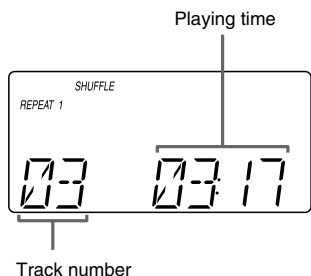

- 1 Press **CD** (CD/REMAIN on the remote).

- 2 Press **SHUFFLE** or **ENTER/PGM** (TUNER MEM/ENTER/PGM on the remote) repeatedly until the mode you want appears in the display.

Select	To play
No display (Normal Play)	The CD in original order.
SHUFFLE (Shuffle Play)	The tracks on the CD in random order.
PROGRAM (Program Play)	The tracks on the CD in the order you want them to be played (see "Programing the CD tracks" on page 9).

- 3 Press **▶II**.

Other Operations

To	Do this
Stop playback	Press ■ .
Pause	Press ▶II . Press again to resume play.
Select a track	Turn ◀◀/▶▶ clockwise or counterclockwise (or press ◀◀ or ▶▶ on the remote).
Find a point in a track	During play, turn and hold ◀◀/▶▶ clockwise or counterclockwise (or keep pressing ◀◀ or ▶▶ on the remote). Release it when you find the desired point.
Play repeatedly (Repeat Play)	Press REPEAT during play until "REPEAT" or "REPEAT 1" appears. REPEAT: For all the tracks on the CD. REPEAT 1: For a single track only. To cancel playing repeatedly, press REPEAT until "REPEAT" or "REPEAT 1" disappears.
Remove the CD	Press ▲ PUSH OPEN/CLOSE.

Programming the CD tracks

— Program Play

You can make a program of up to 28 tracks in the order you want them to be played.

- 1 Press CD (CD/REMAIN on the remote), then place a CD.**
- 2 Press ENTER/PGM (TUNER MEM/ENTER/PGM on the remote) repeatedly until “00 PR.01” appears in the display.**
- 3 Turn I◀/▶I clockwise or counterclockwise (or press I◀◀ or ▶▶ on the remote) until the desired track appears in the display.**

Programed step number

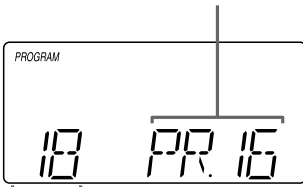

Selected track number
(including selected track)

- 4 Press ENTER/PGM (TUNER MEM/ENTER/PGM on the remote).**

The track is programmed. The next program step number appears, and “PROGRAM” flashes.

- 5 To program additional tracks, repeat steps 3 to 4.**

- 6 Press ▶II.**

Program Play starts.

To	Do this
Check the total number of programmed tracks	Press ENTER/PGM (TUNER MEM/ENTER/PGM on the remote) repeatedly in stop mode. Each time you press the button, the selected track number and the programmed step number appear in the display in turn.
Cancel Program Play	Press ■ twice until “PROGRAM” disappears from the display. The program you made will be erased.

Tip

The program you made remains after Program Play finishes. When Program Play remains in the system’s memory, “PROGRAM” flashes. To play the same program again, press CD (CD/REMAIN on the remote) and ENTER/PGM (TUNER MEM/ENTER/PGM on the remote), then press ▶II.

Presetting radio stations

You can preset up to 24 stations for FM and AM. You can then tune in any of those stations simply by selecting the corresponding preset number.

There are two ways to store the station presets.

To	Method
Automatically tune all of the stations that can be received in your area and then store them manually	Automatic Tuning Preset
Manually tune and store the radio frequency of your favourite stations	Manual Tuning Preset

Setting presets through automatic tuning

- 1 Press **TUNER** (**TUNER/BAND** on the remote) repeatedly to select “FM” or “AM”.
- 2 Turn and hold **TUNING +/-** (or press and hold **TUNING +** or **-** on the remote) until the frequency indication starts to change, then release it.

Scanning stops automatically when the system tunes in a station. “STEREO” (for a stereo program) appears.

If the scanning doesn't stop

Set the frequency of the desired radio station as described in steps 2 through 6 of “Setting presets through manual tuning”.

- 3 Press **TUNER MEM** (**TUNER MEM/ENTER/PGM** on the remote).
A preset number appears in the display. The stations are stored from preset number 1.

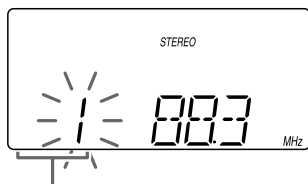

Preset number

- 4 Press **PRESET +** or **-** until the preset number you want for the station flashes.
- 5 Press **ENTER/PGM** (**TUNER MEM/ENTER/PGM** on the remote).
The station is stored.
- 6 Repeat steps 1 to 5 to store other stations.

Setting presets through manual tuning

- 1 Press **TUNER** (**TUNER/BAND** on the remote) repeatedly to select “FM” or “AM”.
- 2 Turn **TUNING +/-** (or press **TUNING +** or **-** on the remote) repeatedly to tune in the desired station.
- 3 Press **TUNER MEM** (**TUNER MEM/ENTER/PGM** on the remote).
A preset number appears in the display. The stations are stored from preset number 1.



Preset number

- 4 Press **PRESET +** or **-** repeatedly to select the desired preset number.
- 5 Press **ENTER/PGM** (**TUNER MEM/ENTER/PGM** on the remote).
The station is stored.
- 6 Repeat steps 1 to 5 to store other stations.

Other Operations

To	Do this
Tune in a station with a weak signal	Follow the procedure described in “Setting presets through manual tuning”.
Change the preset number	Start over from step 1.
Set another station to an existing preset number	Start over from step 1. After step 3, press PRESET + or – repeatedly to select the preset number where you want to store the other station and then press ENTER/PGM (TUNER MEM/ENTER/PGM on the remote).

To change the AM tuning interval (except for the European and Middle Eastern models)

Disconnect the power cord from the wall outlet first, and then set the AM FREQ STEP switch at the rear to 9 kHz or 10 kHz.

Tip

The preset stations are retained for half a day even if you unplug the power cord or if a power failure occurs.

Listening to the radio

You can listen to a radio station either by selecting a preset station, or by manually tuning in the station.

Listening to a preset station

— Preset Tuning

Preset radio stations in the tuner’s memory first (see “Presetting radio stations” on page 10).

- 1 Press TUNER (TUNER/BAND on the remote).

- 2 Press PRESET + or – repeatedly to tune in the desired preset station.

The preset number appears in the display for a few seconds.

When only one station is preset, only that station is tuned.

Listening to non-preset radio station

— Manual Tuning

- 1 Press TUNER (TUNER/BAND on the remote) repeatedly to select “FM” or “AM”.

- 2 Turn TUNING +/- (or press TUNING + or – on the remote) repeatedly to tune in the desired station.

Tip

To improve broadcast reception, adjust the antenna (for FM) or reorient the main unit itself (for AM).

Loading a tape

- 1** Press ■▲
- 2** Insert a tape in deck with the side you want to play/record facing forward.

Insert with the side you want to play/record facing forward.

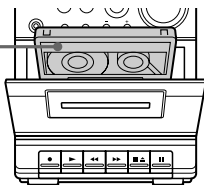

Playing a tape

You can use TYPE I (normal) tape.

- 1** Load a recorded tape.
- 2** Press TAPE.
- 3** Press ►.

To	Press
Stop play	■▲
Pause	 Press again to resume play.
Fast-forward or rewind	◀◀ or ▶▶
Remove the cassette	■▲

Recording to a tape

— CD Synchro Recording/Recording Manually

You can record from a CD or radio. You can use TYPE I (normal) tape.

Steps	Recording from a CD (CD Synchro Recording)	Recording from the radio
1	Load a blank tape.	
2	Press CD (CD/REMAIN on the remote).	Press TUNER (TUNER/BAND on the remote).
3	Load the CD you want to record.	Tune in the station you want to record.
4	Press ●	Press II and ● The deck stands by for recording. Press II again.

To stop recording

Press **■▲**.

Tip

For recording from a CD to a tape, you can turn **⏮/⏭** clockwise or counterclockwise (or press **⏮** or **⏭** on the remote) to select tracks before step 4.

Adjusting the sound

Reinforcing the bass sound

— MEGA BASS

You can listen to music with stronger bass tones.

Press MEGA BASS.

“MEGA BASS” appears in the display and the bass is reinforced.

Press again to cancel MEGA BASS.

Selecting the preset effect from the music menu

Press MUSIC MENU repeatedly to select the preset effect you desire.

Each time you press the button, the display changes cyclically as follows:

ROCK → POP → JAZZ → No display → ROCK → ...

Turning off the sound

— Muting

You can turn off the sound temporarily.

Press MUTING on the remote.

Press again to cancel muting.

Tip

You can also turn up the volume by turning VOLUME clockwise or turning off the power and turning it on again.

Falling asleep to music

— Sleep Timer

You can set the system to turn off after certain amount of time, so that you can fall asleep to music.

1 Press CLOCK/TIMER/SLEEP SET on the remote repeatedly until “SLEEP OFF” appears in the display.

2 Press CLOCK/TIMER + or – on the remote to select the minutes until the player goes off automatically.

Every time you press the button, the minute display (the turn-off time) changes as follows:

90 ↔ 80 ↔ 70 ↔ ... ↔ 10 ↔ OFF

3 Press TUNER MEM/ENTER/PGM on the remote.

To	Do this
Change the time to turn off	Start over from step 1.
Cancel the Sleep Timer function	Start over from step 1 and select “OFF” on step 2.

Waking up to music

— Daily Timer

You can wake up to music at a preset time. Make sure you have set the clock (see “Setting the clock” page 7).

- 1 Prepare the sound source you want to play.**
 - CD: Place a CD.
 - Radio: Tune in the preset station you want (see “Listening to the radio” on page 11).
- 2 Adjust the volume.**
- 3 Press CLOCK/TIMER/SLEEP SET on the remote repeatedly until “ON 0:00” appears in the display.**
- 4 Set the time to start playback using CLOCK/TIMER + or – on the remote.**
- 5 Press TUNER MEM/ENTER/PGM on the remote.**
- 6 Press CLOCK/TIMER/SLEEP SET on the remote repeatedly until “OFF 0:00” appears in the display.**
- 7 Set the time to stop playback using CLOCK/TIMER + or – on the remote.**
- 8 Press TUNER MEM/ENTER/PGM on the remote.**
- 9 Press CD/REMAIN or TUNER/BAND on the remote depending on the sound source you want to play.**
- 10 Turn off the power and press TIMER ON/OFF on the remote.**

The TIMER indicator lights up.

To	Do this
Check the setting	Press CLOCK/TIMER/SLEEP SET on the remote repeatedly.
Change the setting	Start over from step 1.
Cancel the timer operation	Press TIMER ON/OFF on the remote.

Using the CD display

Press **CD/REMAIN** on the remote repeatedly.

The display changes as follows:

During normal play

Elapsed playing time on the current track →

Remaining time on the current track →

Remaining time on the current CD →

Elapsed playing time on the current track →.

Problems and remedies

If you have any problem using this system, use the following check list.

First, check that the power cord is connected firmly and the speakers are connected correctly and firmly.

Should any problem persist, consult your nearest Sony dealer.

General

The clock indication does not show the correct time.

- A power interruption occurred. Set the clock and timer settings again.

The clock setting/radio presetting/timer is canceled.

- The power cord is disconnected or a power failure occurs longer than half a day.

Redo the following:

— “Setting the clock” on page 7

— “Presetting radio stations” on page 10

If you have set the timer, also redo “Waking up to music” on page 15.

There is no sound.

- Turn VOLUME clockwise and hold.
- The headphones are connected.
- Insert only the stripped portion of the speaker cord into the SPEAKER terminal. Inserting the vinyl portion of the speaker cord will obstruct the speaker connections.

There is severe hum or noise.

- A TV or VCR is placed too close to the stereo system. Move the stereo system away from the TV or VCR.

The timer does not function.

- Set the clock correctly.
- When you used the Sleep Timer, the Daily Timer will not turn on the system until the Sleep Timer turns it off.

The remote does not function.

- There is an obstacle between the remote and the system.
 - The remote is not pointing in the direction of the system's sensor.
 - The batteries have run down. Replace the batteries.
-

The color irregularity on a TV screen persists.

- Turn off the TV set once, then turn it on after 15 to 30 minutes. If the color irregularity still persists, place the speakers farther away from the TV set.
-

Speakers**Sound comes from one channel or unbalanced left and right volume.**

- Check the speaker connection and speaker placement.
-

Sound lacks bass.

- Check that the speaker's + and – terminals are connected correctly.
-

CD Player**The CD compartment does not close.**

- The CD is not placed properly.
-

The sound drops out.

- The lens is dirty. Clean it with a commercially available blower.
-

The CD will not play.

- The CD is not lying flat in the CD compartment.
 - The CD is dirty.
 - The CD is inserted label side down.
 - Moisture condensation has built up. Remove the CD and leave the system turned on for about an hour until the moisture evaporates.
-

Tape Deck**The tape does not record.**

- No tape in the cassette compartment.
 - The tab has been removed from the cassette.
 - The tape has reeled to the end.
-

The tape does not record nor play or there is a decrease in sound level.

- The heads are dirty. Clean them (see "Cleaning the tape heads" on page 19).
 - The record/playback heads are magnetized. Demagnetize them (see "Demagnetizing the tape heads" on page 19).
-

The tape does not erase completely.

- The record/playback heads are magnetized. Demagnetize them (see "Demagnetizing the tape heads" on page 19).
-

There is excessive wow or flutter, or the sound drops out.

- The capstans or pinch rollers are dirty. Clean them (see "Cleaning the tape heads" on page 19).
-

Noise increases or the high frequencies are erased.

- The record/playback heads are magnetized. Demagnetize them (see "Demagnetizing the tape heads" on page 19).
-

Tuner**Noise is heard.**

- For FM, move the antenna to reduce the noise. For AM, reorient the main unit itself to reduce the noise.
-

Messages

The following message may appear in the display during operations.

NO DISC

- There is no disc on the CD compartment.
-

Precautions

On operating voltage

Before operating the system, check that the operating voltage of your system is identical with the voltage of your local power supply.

On safety

- The unit is not disconnected from the AC power source (mains) as long as it is connected to the wall outlet, even if the unit itself has been turned off.
- Unplug the system from the wall outlet (mains) if it is not to be used for an extended period of time. To disconnect the cord (mains lead), pull it out by the plug. Never pull the cord itself.
- Should any solid object or liquid fall into the component, unplug the stereo system and have the component checked by qualified personnel before operating it any further.
- The AC power cord must be changed only at a qualified service shop.
- The nameplate is located on the bottom exterior.

On placement

- Place the unit in a location with adequate ventilation to prevent heat build-up the unit.
- Do not place the unit in an inclined position.
- Do not place the unit in locations where it is:
 - Extremely hot or cold
 - Dusty or dirty
 - Very humid
 - Vibrating
 - Subject to direct sunlight.
- Use caution when placing the unit or speakers on surfaces that have been specially treated (with wax, oil, polish, etc.) as staining or discoloration of the surface may result.

On heat buildup

- Although the unit heats up during operation, this is not malfunction.
- Place the unit in a location with adequate ventilation to prevent heat build-up in the unit.

If you continuously use this unit at a large volume, the cabinet temperature of the top, side and bottom rises considerably. To avoid burning yourself, do not touch the cabinet.

On operation

- If the system is brought directly from a cold to a warm location, or is placed in a very damp room, moisture may condense on the lens inside the CD player. Should this occur, the system will not operate properly. Remove the CD and leave the system turned on for about an hour until the moisture evaporates.
- When you move the system, take out any discs.

If you have any questions or problems concerning your stereo system, please consult your nearest Sony dealer.

Notes on CDs

- Before playing, clean the CD with a cleaning cloth. Wipe the CD from the center out.
- Do not use solvents.
- Do not expose the CD to direct sunlight or heat sources.
- Discs with non-standard shapes (e.g., heart, square, star) cannot be played on this system. Attempting to do so may damage the system. Do not use such discs.

Note on CD-R/CD-RW playback

Discs recorded on CD-R/CD-RW drives may not be played back because of scratches, dirt, recording condition or the drive's characteristics. Besides, the discs, which are not yet finalized at the end of recording cannot be played back.

Cleaning the cabinet

Use a soft cloth slightly moistened with mild detergent solution.

To save a tape permanently

To prevent a tape from being accidentally recorded over, break off the cassette tab from side A or B as illustrated.

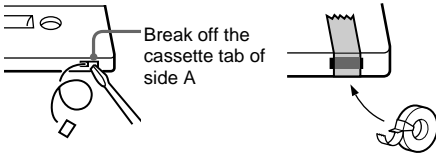

If you later want to reuse the tape for recording, cover the broken tab with adhesive tape.

Before placing a cassette in the tape deck

Take up any slack in the tape. Otherwise the tape may get entangled in the parts of the tape deck and become damaged.

When using a tape longer than 90 minutes

The tape is very elastic. Do not change the tape operations such as play, stop, and fast-winding (etc.) frequently. The tape may get entangled in the tape deck.

Cleaning the tape heads

Clean the tape heads after every 10 hours of use. Make sure to clean the tape heads before you start an important recording or after playing an old tape. Use separately sold dry-type or wet-type cleaning cassette. For details, refer to the instructions of the cleaning cassette.

Demagnetizing the tape heads

Demagnetize the tape heads and the metal parts that have contact with the tape every 20 to 30 hours of use with a separately sold demagnetizing cassette. For details, refer to the instructions of the demagnetizing cassette.

Specifications

Amplifier section

AUDIO POWER SPECIFICATIONS: (U.S.A. model only)

POWER OUTPUT AND TOTAL HARMONIC DISTORTION:

with 4 Ω loads both channels driven, from 120 - 10,000 Hz; rates 6 W per channel minimum RMS power, with no more than 10% total harmonic distortion from 250 mW to rated output.

Canadian model:

Continuous RMS power output (reference)
6 + 6 W
(4 Ω at 1 kHz, 10% THD)

European model:

DIN power output (rated) 4.5 + 4.5 W
(4 Ω at 1 kHz, DIN)
Continuous RMS power output (reference)
6 + 6 W
(4 Ω at 1 kHz, 10% THD)
Music power output (reference)
13 + 13 W

Other model:

The following measured at AC 230 V or AC 120 V, 50/60 Hz
DIN power output (rated) 4.5 + 4.5 W
(4 Ω at 1 kHz, DIN)
Continuous RMS power output (reference)
6 + 6 W
(4 Ω at 1 kHz, 10% THD)

Outputs

PHONES: Accepts headphones of
(stereo mini jack) 8 Ω or more
SPEAKER: Accepts impedance of 4 to
16 Ω

CD player section

System Compact disc and digital audio system
Laser Semiconductor laser
($\lambda=780$ nm)
Emission duration: continuous
Frequency response 20 Hz - 20 kHz (± 0.5 dB)

continued

Specifications (continued)

Tape player section

Recording system	4-track 2-channel stereo
Frequency response	50 - 13 000 Hz (± 3 dB), using Sony TYPE I cassette
Wow and flutter	$\pm 0.15\%$ W.Peak (IEC) 0.1% W.RMS (NAB) $\pm 0.2\%$ W.Peak (DIN)

Tuner section

FM stereo, FM/AM superheterodyne tuner

FM tuner section

Tuning range	87.5 - 108.0 MHz
Antenna	FM lead antenna
Intermediate frequency	10.7 MHz

AM tuner section

Tuning range	530 - 1 710 kHz
Pan-American model:	(with the interval set at 10 kHz) 531 - 1 602 kHz (with the interval set at 9 kHz)
European model:	531 - 1 602 kHz (with the interval set at 9 kHz)
Other models:	531 - 1 602 kHz (with the interval set at 9 kHz) 530 - 1 710 kHz (with the interval set at 10 kHz)
Antenna	Built-in ferrite bar antenna
Intermediate frequency	450 kHz

Speaker

Speaker system	Bass-reflex type
Speaker units	Full range 10 cm, cone type
Nominal impedance	4 Ω
Dimensions (w/h/d)	Approx. 145 \times 237 \times 170 mm
Mass	Approx. 1.3 kg net per speaker

General

Power requirements	
North American model:	120 V AC, 60 Hz
European model:	230 V AC, 50/60 Hz
Australian model:	230 V AC, 50/60 Hz
Mexican model:	120 V AC, 60 Hz
Argentine model:	220 - 230 V AC, 50/60 Hz
Taiwan model:	110 - 120 V AC, 60 Hz
Other models:	230 V AC, 50/60 Hz

Power consumption

U.S.A. model:	25 W
Canadian model:	25 W
European model:	30 W
	0.5 W (in the standby mode)
Other models:	30 W

Dimensions (w/h/d):

Approx. 145 \times 240 \times 252 mm

Mass:

Approx. 2.9 kg

Supplied accessories:

Remote Commander (1)
Batteries (2)

Design and specifications are subject to change
without notice.