

Compact Hi-Fi Stereo System

Operating Instructions



LBT-LV60

WARNING

To prevent fire or shock hazard, do not expose the unit to rain or moisture.

To avoid electrical shock, do not open the cabinet. Refer servicing to qualified personnel only.

Do not install the appliance in a confined space, such as a bookcase or built-in cabinet.

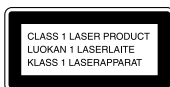



This appliance is classified as a CLASS 1 LASER product. The CLASS 1 LASER PRODUCT MARKING is located on the rear exterior.

This stereo system is equipped with the Dolby* B-type noise reduction system.

* Dolby noise reduction manufactured under license from Dolby Laboratories Licensing Corporation. "DOLBY" and the double-D symbol  are trademarks of the Dolby Laboratories Licensing Corporation.

This system can play the following discs

	VIDEO CDs	Audio CDs
Disc logo		
Contents	Audio + Video (moving pictures)	Audio
Disc size	12 cm/8 cm	12 cm/8 cm
Play time	74 min./20 min.	74 min./20 min.

Note on VIDEO CDs

This system conforms to VIDEO CDs without the PBC functions (Ver. 1.1) and VIDEO CDs with the PBC functions (Ver. 2.0) of VIDEO CD standards. You can enjoy two kinds of playback according to the disc type.

Disc type	You can
VIDEO CDs without the PBC functions (Ver. 1.1 discs)	Enjoy video playback (moving pictures) as well as audio CDs.
VIDEO CDs with the PBC functions (Ver. 2.0 discs)	Play interactive software using menu screens displayed on the TV screen (menu playback), in addition to the video playback function of VIDEO CDs without the PBC functions. Moreover, you can play high or standard quality still picture.

* PBC = Play Back Control

Table of Contents

Getting Started

Step 1: Hooking up the system	4
Step 2: Setting the time	7
Step 3: Presetting radio stations	8

Basic Operations

Playing a VIDEO CD	10
Playing a CD	12
Recording a VIDEO CD/CD	14
Listening to the radio	15
Recording from the radio	16
Playing a tape	18
Recording from a tape	19

The VIDEO CD/CD Player

Playing a VIDEO CD with the PBC functions (Ver. 2.0)	21
Using the CD display	22
Using the on-screen display	24
Locating a specific part of a disc	26
Resuming playback from the point you stopped a VIDEO CD	29
Setting the sharpness	30
Playing CD tracks repeatedly	31
Playing CD tracks in random order	31
Programming CD tracks	32
Playing CDs without interruption	34

The Tape Deck

Recording on a tape manually	35
Recording CDs by specifying the track order	36

DJ Effects

Looping part of a CD	38
Flashing part of a CD	38

Sound Adjustment

Adjusting the sound	39
Selecting the audio emphasis	40
Adjusting the audio emphasis	41
Making a personal audio emphasis file	43

Other Features

Singing along: Karaoke	44
Falling asleep to music	46
Waking up to music	47
Timer-recording radio programs	48

Optional AV Components

Connecting audio components	50
Connecting video components	51
Connecting outdoor antennas	52

Additional Information

Precautions	53
Troubleshooting	54
Specifications	56
Glossary	58
Index	59

Step 1: Hooking up the system

Follow steps **1** through **5** to hook up your system using the supplied cords and accessories.

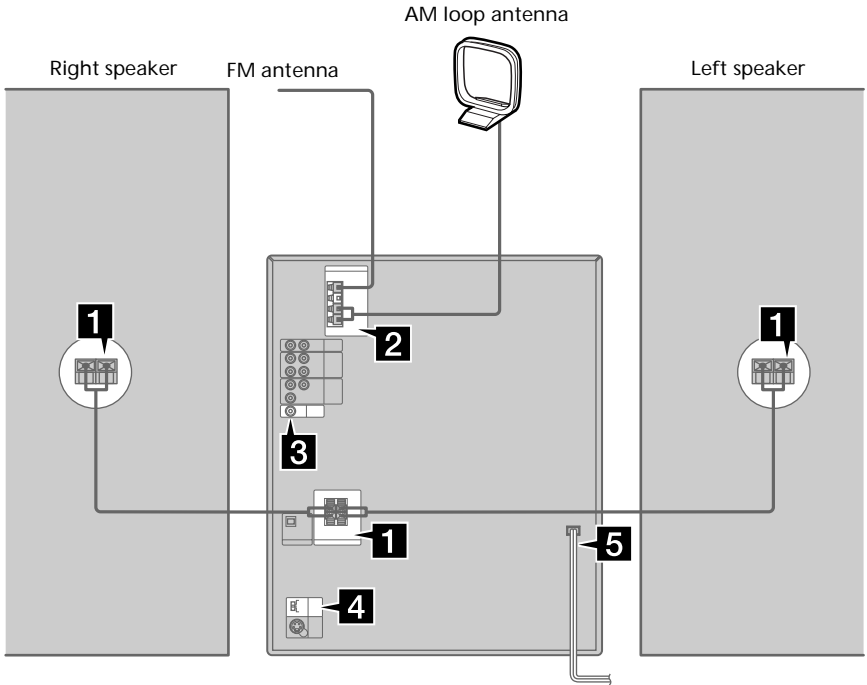

1 Connect the speakers.

- 1 Connect the speaker cords to the FRONT SPEAKER jacks.

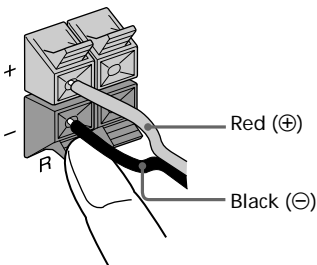

- 2 Insert only the stripped portion of the cord. Inserting the vinyl portion will interfere with the speaker connection and no sound will come from the speaker.

Note

Keep the speaker cords away from the antennas to prevent noise.

- 2** Connect the FM/AM antennas. Set up the AM loop antenna, then connect it.

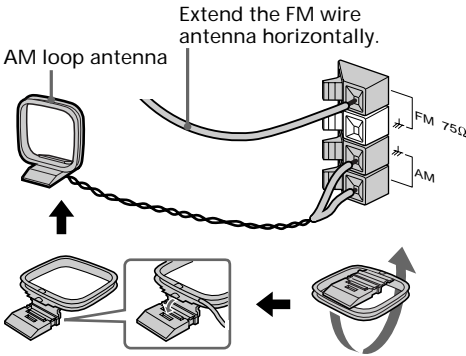

If your TV automatically changes the color system according to the input signal:

The factory setting (AUTO) automatically changes the color system of the video output according to the color system of the current VIDEO CD.

If the color system of your TV is NTSC:
Set SYSTEM SELECT to NTSC.

Pictures recorded in the PAL color system will be stretched vertically and will be displayed with the upper and lower parts of the picture cut off.

If the color system of your TV is PAL:
Set SYSTEM SELECT to PAL.

Pictures recorded in the NTSC color system will be stretched horizontally and will be displayed with the upper and lower parts of the screen masked in black.

- 3** Connect the video input jack of your TV to the VIDEO OUT jack of this system using the supplied video connecting cable.

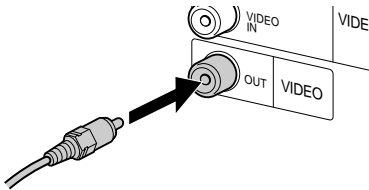

Notes

- Be sure to turn off the system before changing the SYSTEM SELECT setting.
- Even if you change the color system using the SYSTEM SELECT, the color system of the signal input from the VIDEO1 and VIDEO2 INPUT jacks does not change.

When using a TV

Turn on the TV and select the video input to view pictures from this system.

Tip

When your TV has an S VIDEO jack, for the best picture quality, you can use an optional S VIDEO cable to connect it to the S VIDEO OUT jack on the rear panel of this system. Note that the input signal from the VIDEO1 and VIDEO2 INPUT jacks do not output via the S VIDEO OUT jack.

- 5** Connect the power cord to a wall outlet.

The demonstration appears in the display. When you press I/⏏, the system turns on and the demonstration automatically stops.

- 4** Set SYSTEM SELECT (color system) to the appropriate position (PAL or NTSC), according to your TV.

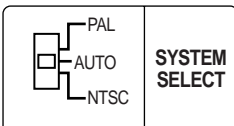

Step 1: Hooking up the system (continued)

To connect optional AV components

See page 50.

To deactivate the demonstration

When you set the time (see "Step 2 Setting the time"), the demonstration is deactivated.

To activate/deactivate the demonstration again, press DEMO (STAND BY) while the system is off.

Inserting two R6 (size AA) batteries into the remote

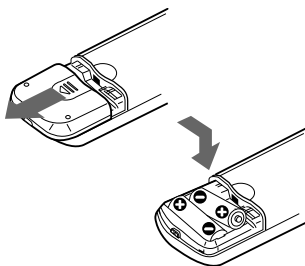

Tip

With normal use, the batteries should last for about six months. When the remote no longer operates the system, replace both batteries with new ones.

Note

If you do not use the remote for a long period of time, remove the batteries to avoid possible damage from battery leakage.

Using the remote

You can control Sony TVs using the buttons below.

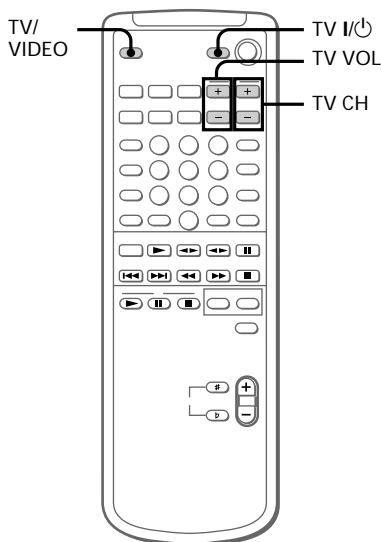

By pressing	You can
TV I/POWER	Turn on or off the TV
TV/VIDEO	Select the input source for the TV
TV VOL	Adjust the volume of the TV
TV CH	Change the channel of the TV

Note

Depending on the TV, you may not be able to control your TV or to use some of the buttons above.

When carrying this system

Do the following to protect the CD mechanism.

Make sure that all discs are removed from the unit.

- 1 Press FUNCTION repeatedly until "CD" appears in the display.
- 2 Hold down CD LOOP and press I/POWER to turn off the system.
"LOCK" appears in the display. It is now safe for transportation.

Step 2: Setting the time

You must set the time before using the timer functions.

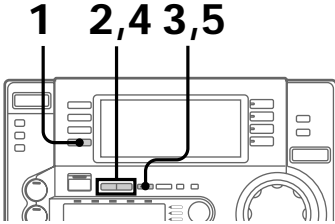

Tip

If you make a mistake, start over from step 1.

To change the time

The previous explanation shows you how to set the time while the power is off. To change the time while the power is on, do the following:

- 1 Press \ominus /CLOCK SET.
- 2 Press TUNING +/- to select SET CLOCK.
- 3 Press ENTER/NEXT.
- 4 Perform steps 2 through 5 in the previous explanation.

Note

The clock setting is canceled when you disconnect the power cord or if a power failure occurs.

-
- 1 Press \ominus /CLOCK SET.
The hour indication flashes.



-
- 2 Press TUNING +/- to set the hour.



-
- 3 Press ENTER/NEXT.
The minute indication flashes.



-
- 4 Press TUNING +/- to set the minute.



-
- 5 Press ENTER/NEXT.
The clock starts.
-

Step 3: Presetting radio stations

You can preset up to 30 stations, 20 for FM and 10 for AM.

The bands you can select depend on the kind of tuner built into your system. Confirm the bands by pressing TUNER/BAND repeatedly.

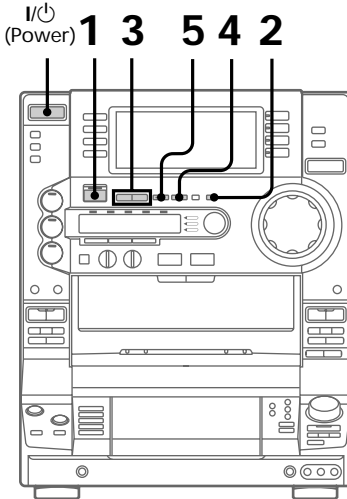

-
- 1 Press TUNER/BAND repeatedly until the desired band appears in the display.

Each time you press this button, the band changes as follows:

FM ↔ AM

-
- 2 Press TUNING MODE repeatedly until “AUTO” appears in the display.

-
- 3 Press TUNING +/-.

The frequency indication changes and scanning stops when the system tunes in a station. “TUNED” and “STEREO” (for a stereo program) appear.



-
- 4 Press TUNER MEMORY.

The next available preset number flashes in the display. The stations are stored from preset number 1.

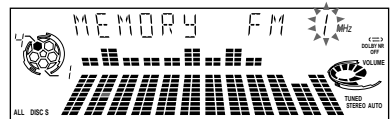

-
- 5 Press ENTER/NEXT.

The station is stored.

-
- 6 Repeat steps 1 through 5 to store other stations.
-

To tune in a station with a weak signal

Press TUNING MODE repeatedly until "MANUAL" appears in step 2, then press TUNING +/- to tune in a station.

To store another station on an existing preset number

Start over from step 1. After step 4, press TUNING +/- to select the preset number on which you want to store the station.

You can add a new preset number after the last preset number.

To erase a preset number

- 1** Press and hold TUNER MEMORY until a preset number flashes in the display.
- 2** Press TUNING +/- to select the preset number you want to erase. Select "ALL ERASE" to erase all preset numbers.
- 3** Press ENTER/NEXT.

When you erase a preset number, all the following preset numbers shift up and reduce by one.

To change the AM tuning interval

The AM tuning interval is factory-preset to 9 kHz (10 kHz in some areas). To change the AM tuning interval to 10 kHz (or 9 kHz), press TUNER/BAND repeatedly until "AM" appears, then turn off the system. While holding down ENTER, turn the system back on. When you change the interval, the AM preset stations will be erased. To reset the interval, repeat the same procedure.

Note

The preset stations are canceled when you disconnect the power cord or if a power failure occurs for more than half a day.

Playing a VIDEO CD

You can play both VIDEO CDs without PBC functions (Ver. 1.1) and VIDEO CDs with PBC functions (Ver. 2.0).

You can enjoy two kinds of playback according to the disc type.

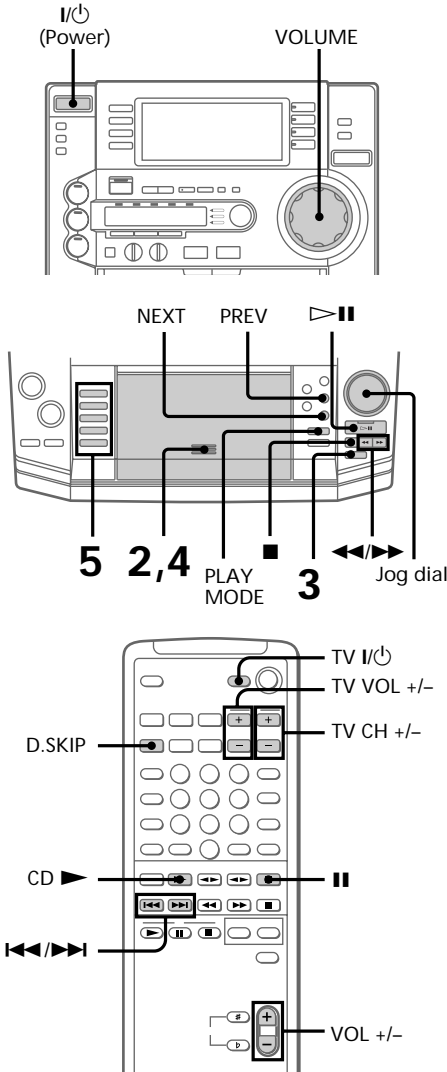

- 1 Turn on your TV and select the video input.
Refer to the instructions included with your TV for details.

- 2 Press PUSH OPEN and place a VIDEO CD on the disc tray.
If the disc is not placed properly, it will not be recognized.

With the label side up.
When you play a VIDEO CD single, place it on the inner circle of the tray.

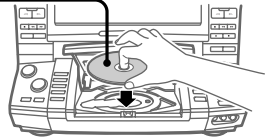

- 3 Press DISC SKIP (or D.SKIP on the remote) to place up to four more VIDEO CDs on the tray.
The disc tray rotates so you can insert other VIDEO CDs.

- 4 Close the front cover.

- 5 Press one of the DISC 1 - DISC 5 buttons.
Playback starts.
If you press ▷|| (or CD ▶ on the remote), playback starts from the CD in the playing position.

Disc number in the playing position
Track number Elapsed time

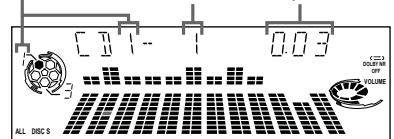

To	Do this
Stop playback	Press ■.
Pause	Press ▷ (or on the remote)* ¹ . Press ▷ again to resume playback (or CD ► on the remote).
Select a track	Press NEXT to go forward, PREV to go back. Or, during play or pause, turn the jog dial clockwise (to go forward) or counterclockwise (to go backward) and release it when you reach the desired track. (Or press ►► (to go forward) or ◀◀ (to go backward) on the remote.)* ²
Find a point in a track or scene (Lock Search function)	Press ►► or ◀◀ during playback. ① Press once to start searching. ② Press again to increase the search speed. Each time you press the button, the speed changes as follows: 1 (slow) → 2 (normal) → 3 (high) → 1 (slow)... ③ Press ▷ at the desired point to stop searching.
Select a VIDEO CD in stop mode	Press one of the DISC 1 - DISC 5 buttons (or DISC SKIP).
Play only the VIDEO CD you have selected	Press PLAY MODE repeatedly until "1 DISC" appears.
Play all VIDEO CDs* ³	Press PLAY MODE repeatedly until "ALL DISCS" appears.
Remove or change the VIDEO CDs	Press PUSH OPEN.
Adjust the volume	Turn VOLUME (or press VOL +/- on the remote).

*¹ There may be some disturbance in the paused video image.

*² Only for VIDEO CDs without PBC functions (Ver. 1.1).

*³ This function cannot be used during playback of a VIDEO CD with the PBC functions (Ver. 2.0).

Tips

- Pressing ▷|| while the system power is off automatically turns on the system and starts VIDEO CD playback if there is a VIDEO CD on the tray (One Touch Play).
- You can switch from another source and begin playing a VIDEO CD just by pressing ▷||, one of the DISC 1 - DISC 5 buttons, or CD ► on the remote (Automatic Source Selection).
- If there is no VIDEO CD in the player, "NO DISC" appears in the display.
- You can change the VIDEO CD which is in the loading position during playback of the VIDEO CD which is in the playing position.

Playing a CD

— Normal Play

You can play up to five CDs in a row.

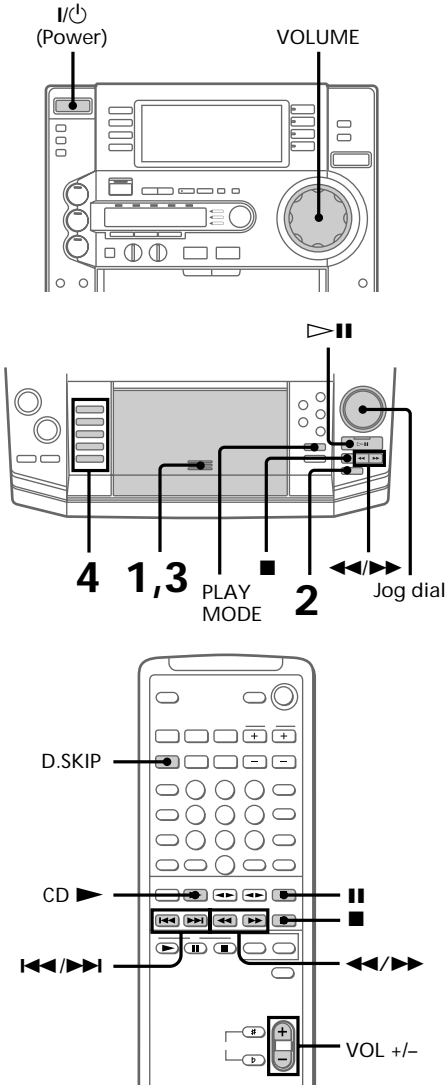

- 1** Press **PUSH OPEN** and place a CD on the disc tray.

If the disc is not placed properly, it will not be recognized.

With the label side up. When you play a CD single, place it on the inner circle of the tray.

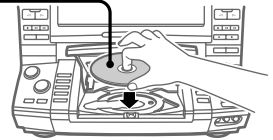

- 2** Press **DISC SKIP** (or **D.SKIP** on the remote) to place up to four more CDs on the tray.

The disc tray rotates so that you can insert other CDs.

- 3** Close the front cover.

- 4** Press one of the **DISC 1 - DISC 5** buttons.

Playback starts.

If you press **▶||** (or **CD ▶** on the remote), playback starts from the CD in the playing position.

Disc number in the playing position
Track number Elapsed time

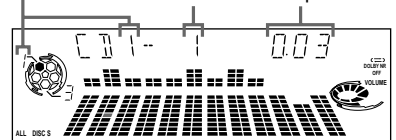

To	Do this
Stop playback	Press ■.
Pause	Press ▷ (or on the remote). Press ▷ again to resume playback (or CD ► on the remote).
Select a track	During playback or pause, turn the jog dial clockwise (to go forward) or counterclockwise (to go backward) and release it when you reach the desired track. Or press AMS* ►► (to go forward) or AMS* ◄◄ (to go backward) on the remote.
Find a point in a track (Lock Search Function)	Press ►► or ◄◄ during playback. Press ▷ at the desired point to stop searching.
Select a CD	Press one of the DISC 1 - DISC 5 buttons (or DISC SKIP).
Play only the CD you have selected	Press PLAY MODE repeatedly until "1 DISC" appears.
Play all CDs	Press PLAY MODE repeatedly until "ALL DISCS" appears.
Remove or change the CDs	Press PUSH OPEN.
Adjust the volume	Turn VOLUME (or press VOL +/- on the remote).

* AMS: Automatic Music Sensor

Tips

- Pressing ▷|| while the system power is off automatically turns on the system and starts CD playback if there is a CD on the tray (One Touch Play).
- You can switch from another source and begin playing a CD just by pressing ▷||, one of the DISC 1 - DISC 5 buttons, or CD ► on the remote (Automatic Source Selection).
- If there is no CD in the player, "NO DISC" appears in the display.
- You can change the CD which is in the loading position during playback of the CD which is in the playing position.

Recording a VIDEO CD/CD

— CD Synchro Recording

This function lets you easily record from a CD to a tape. You can use TYPE I (normal) or TYPE II (CrO₂) tapes. The recording level is automatically adjusted.

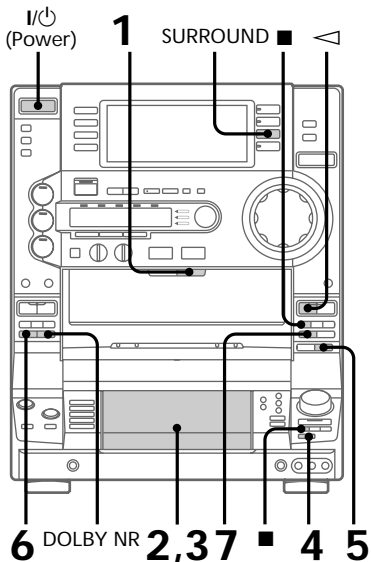

- 1 Press **▲** B EJECT and insert a recordable tape into deck B.

With the side you want to record on facing forward

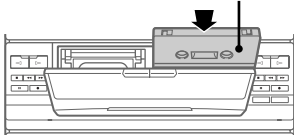

- 2 Press PUSH OPEN and place a CD.

With the label side up. When you play a CD single, place it on the inner circle of the tray.

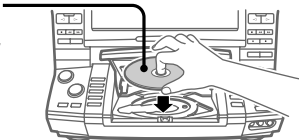

- 3 Close the front cover.
- 4 Press DISC SKIP repeatedly until the number of the disc you want to record from appears in the playing position indicator.
- 5 Press CD SYNC.
Deck B stands by for recording, the CD player stands by for playback, and the indicator on the **▷** button (for the front side) lights up green.
- 6 Press DIRECTION repeatedly until **↔** appears to record on one side, or **↔↔** (or RELAY) to record on both sides.
- 7 Press **||**.
Recording starts.

To stop recording

Press **■** on deck B or on the CD player.

Tips

- When you want to record on the reverse side, press **◁** after pressing CD SYNC in step 5 so that the indicator on the **◁** button (for the reverse side) lights up green.
- When you record on both sides, be sure to start from the front side. If you start from the reverse side, recording stops at the end of the reverse side.
- When you want to reduce the hiss noise in low-level, high-frequency signals, press DOLBY NR before step 7 so that "DOLBY NR B" appears in the display.
- To record with the surround effect, press SURROUND so that "SUR((()))" appears in the display.
The equalizer settings will not be recorded.

Note

You cannot listen to other sources while recording.

Listening to the radio

— Preset Tuning

Before using this function, preset radio stations in the tuner's memory (see "Step 3: Presetting radio stations" on page 8).

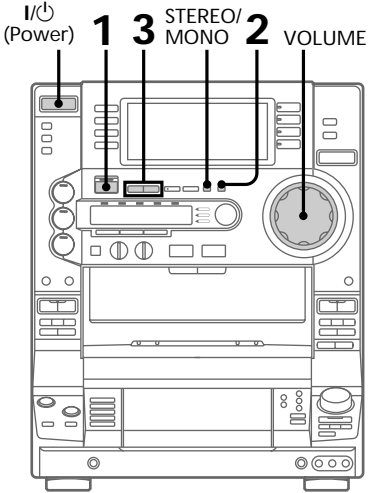

1 Press TUNER/BAND repeatedly until the desired band appears in the display.

Each time you press this button, the band changes as follows:
FM ↔ AM

2 Press TUNING MODE repeatedly until "PRESET" appears in the display.

MANUAL → AUTO → PRESET

3 Press TUNING +/- (or ◀▶/▶▶ on the remote) to tune in the desired preset station.

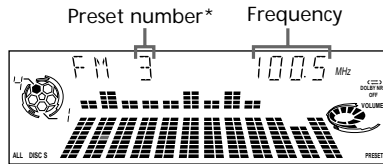

* When only one station is preset, "ONE PRESET" appears in the display.

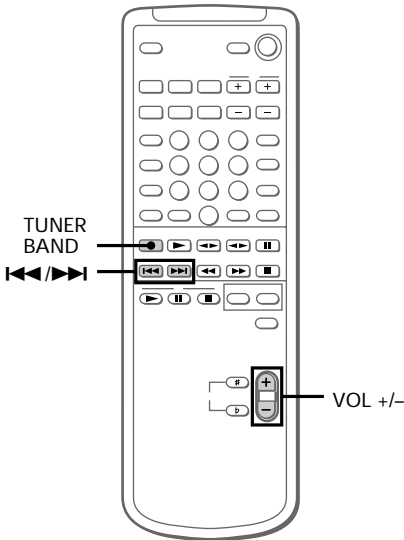

Listening to the radio (continued)

To	Do this
Turn off the radio	Press I/⏻.
Adjust the volume	Turn VOLUME (or press VOL +/- on the remote).

To listen to non-preset radio stations

Press TUNING MODE repeatedly in step 2 until "MANUAL" appears, then press TUNING +/- to tune in the desired station.

Tips

- Pressing TUNER/BAND while the system power is off automatically turns on the system and tunes in the last received station (One Touch Play).
- You can switch from another source to the radio by pressing TUNER/BAND (Automatic Source Selection).
- If an FM program is noisy, press STEREO/MONO so that "MONO" appears in the display. There will be no stereo effect, but the reception will improve. Press this button again to restore the stereo effect.
- To improve broadcast reception, move the supplied antennas.

Recording from the radio

You can record a radio program onto a tape by tuning in a preset station. You can use TYPE I (normal) or TYPE II (CrO₂) tapes. The recording level is automatically adjusted.

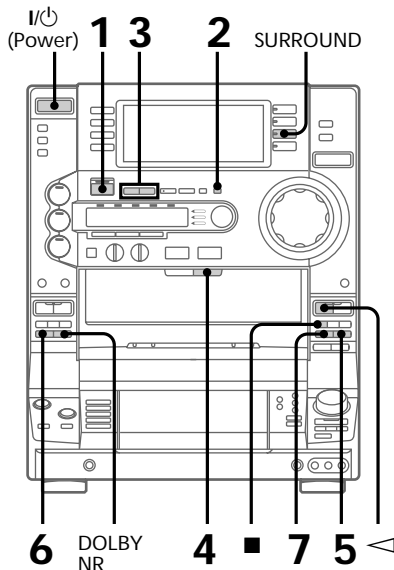

1 Press TUNER/BAND repeatedly until the desired band appears in the display.

2 Press TUNING MODE repeatedly until "PRESET" appears in the display.

-
- 3** Press TUNING +/- to tune in the desired preset station.

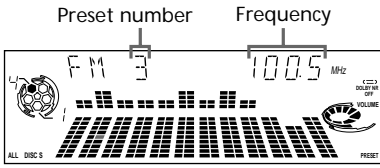

-
- 4** Press **▲** B EJECT and insert a recordable tape into deck B.

With the side you want to record on facing forward

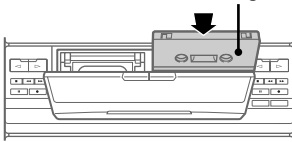

-
- 5** Press **●** REC.
Deck B stands by for recording, and the indicator on the **▷** button (for the front side) lights up green.

-
- 6** Press DIRECTION repeatedly until **↔** appears to record on one side, or **↔↔** (or RELAY) to record on both sides.

-
- 7** Press **||**.
Recording starts.

To stop recording

Press **■** on deck B.

Tips

- When you want to record on the reverse side, press **◀** after pressing **●** REC in step 5 so that the indicator on the **◀** button (for the reverse side) lights up green.
- When you record on both sides, be sure to start from the front side. If you start from the reverse side, recording stops at the end of the reverse side.
- To record non-preset stations, select "MANUAL" in step 2, then press TUNING +/- to tune in the desired station.
- When you want to reduce the hiss noise in low-level, high-frequency signals, press DOLBY NR before step 7 so that "DOLBY NR B" appears in the display.
- To record with the surround effect, press SURROUND so that "SUR(((|||||)))" appears in the display.
The equalizer settings will not be recorded.
- To improve broadcast reception, move the supplied antennas.

Playing a tape

You can play any type of tape, TYPE I (normal), TYPE II (CrO₂), or TYPE IV (metal). The deck automatically detects the tape type. You can also use the AMS* functions to quickly locate the desired songs.

To select either deck A or B, press DECK A ◀▶ or DECK B ◀▶ on the remote.

* AMS: Automatic Music Sensor

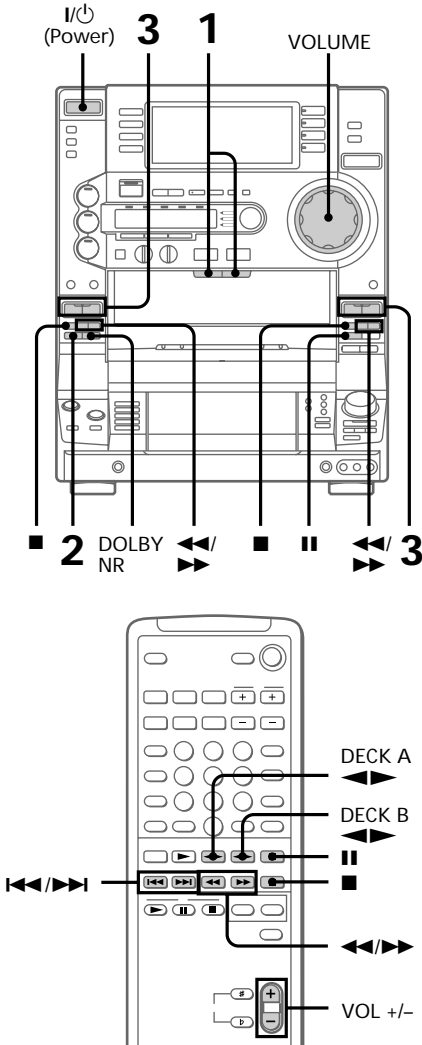

- 1 Press A EJECT ▲ (or ▲ B EJECT) and insert a recorded tape.

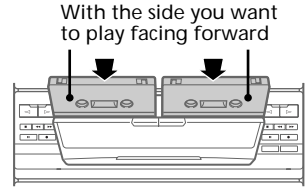

- 2 Press DIRECTION repeatedly to select ◀▶ to play one side, ◀▶◀▶ to play both sides, or RELAY (Relay Play)* to play both decks in succession.

- 3 Press ▶◀ (or DECK A ◀▶, DECK B ◀▶ on the remote). Press ◀▶ (or DECK A ◀▶, DECK B ◀▶ on the remote) to play the reverse side. The tape starts playing.

* Relay Play always plays according to the following sequence:

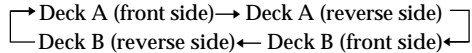

To	Do this
Stop play	Press ■.
Pause (Deck B only)	Press ■. Press again to resume playback.
Fast-forward	Press ▶▶ or ◀◀.
Rewind	Press ◀◀ or ▶▶.
Remove the cassette	Press A EJECT ▲ (or ▲ B EJECT).
Adjust the volume	Turn VOLUME (or press VOL +/- on the remote).

To search for the beginning of a track (AMS)

Press ►► to search forward or ◀◀ to search backward when playing the front side (or vice-versa when playing the reverse side). When you use the remote, ◀◀ or ►►.

The search direction, + (forward) or - (backward), and number of songs being skipped (1 - 9) appear in the display.

Example: searching forward 2 songs

TAPE A : : : +2

Tips

- Pressing ▷ or ◁ while the system power is off automatically turns on the system and starts tape playback if there is a tape in the deck (One Touch Play).
- You can switch from another source to the tape deck by pressing ▷ or ◁ (Automatic Source Selection).
- You can fast-forward or rewind the tape, regardless of the selected source.
- When you want to reduce the hiss noise in low-level, high-frequency signals, press DOLBY NR so that "DOLBY NR B" appears in the display.

Notes

- The deck stops automatically after playing both sides five times.
- The AMS function may not operate correctly under the following circumstances:
 - When the unrecorded space between songs is less than 4 seconds long.
 - If completely different information is recorded on the left and right channels.
 - When there are continuous sections of extremely low level or low frequency sound (like those of a baritone sax).
 - When the system is placed near a TV. (In this case, we recommend moving the system farther away from the TV or turning off the TV.)

Recording from a tape

— High-speed Dubbing

You can use TYPE I (normal) or TYPE II (CrO₂) tapes. The recording level is automatically adjusted.

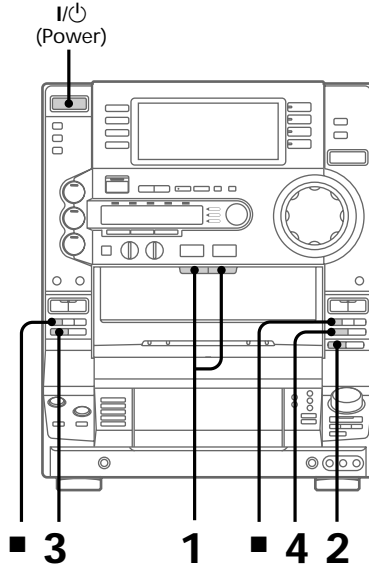

- 1 Press A EJECT ▲ and ▲ B EJECT and insert a recorded tape in deck A and a recordable tape in deck B.

With the side you want to play/record on facing forward

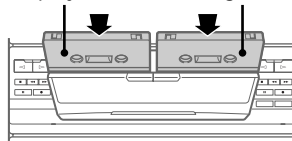

- 2 Press H SPEED DUB.
Deck B stands by for recording.

Recording from a tape (continued)

3 Press DIRECTION repeatedly until \rightleftarrows appears to record on one side, or \leftrightarrow (or RELAY) to record on both sides.

4 Press **II**.
Dubbing starts.
When dubbing ends, decks A and B automatically stop.

To stop dubbing

Press **■** on deck A or B.

Tips

- When you record on both sides, be sure to start from the front side. If you start from the reverse side, recording stops at the end of the reverse side.
- You don't have to set DOLBY NR, since the tape in deck B is automatically recorded in the same state as the tape in deck A.

Notes

- If you set DIRECTION to \leftrightarrow , when the tapes you use have different lengths, the tape in each deck reverses independently. If you select RELAY, the tapes in both decks reverse together.
- You cannot record the surround effect.

Playing a VIDEO CD with the PBC functions (Ver. 2.0)

-- PBC Play

The PBC (Play Back Control) function displays menus on your TV screen to let you enjoy interactive software.

Be sure to read the instructions supplied with each disc for details regarding its use, since different discs have different menu formats and structures.

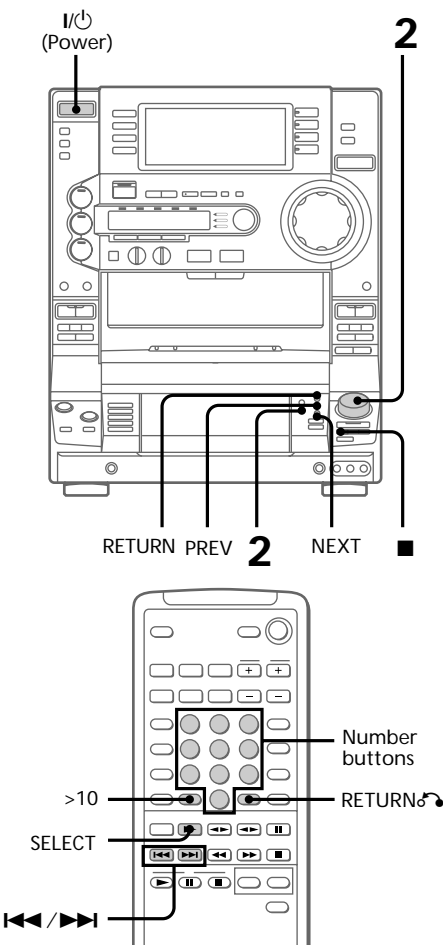

- 1 Start playing a VIDEO CD with the PBC functions (Ver. 2.0).
A PBC menu appears on your TV and "PBC" appears in the display.
- 2 Turn the jog dial to select a number from the menu, then press SELECT.
- 3 Continue according to the instructions on the menus to enjoy interactive playback.

To	Do this
Stop play	Press ■.
See the rest of a menu	Press NEXT.
Go back to the top of a menu	Press PREV.
Go back to a previous menu	Press RETURN (or ⏪ RETURN on the remote).

To disable the PBC functions (Ver. 2.0) of VIDEO CDs

There are two ways to disable the PBC functions.

- Before you start playing, select the desired track using the jog dial, then press SELECT (or press ⏪/⏩, then press SELECT on the remote).
- Before you start playing, select the track number using the number buttons on the remote.

"PBC OFF" appears in the display and playback begins from the selected track. Still images, such as the menu screens, will not be shown.

To select a menu number using the remote

Press the number buttons in the desired order in step 2. To enter track numbers 10 or over, first press >10, then press the number buttons. To enter 0, use the 10/0 button.

Playing a VIDEO CD with the PBC functions (Ver. 2.0) (continued)

Tips

- When  appears on the TV screen, you have pressed an invalid button. Press a button indicated by the instructions on the menu screen.
- When you press NEXT during playback or while playing moving pictures, the next scene on the disc appears. Also refer to the instructions supplied with the disc.
- "PBC" appears for the disc with the PBC functions, and "PBC OFF" appears when its function is canceled.

Note

During playback, you cannot go to the next disc, even if you've selected "ALL DISCS."
Press DISC SKIP (or D. SKIP on the remote) to go to the next disc.

Using the CD display

You can check the remaining time of the current track or that of the CD.

DISPLAY

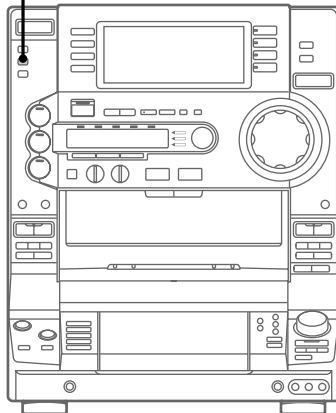

➔ Press DISPLAY.

Each time you press this button during Normal Play or in stop mode, the display changes as follows:

During Normal Play of a VIDEO CD with the PBC functions (Ver. 2.0)

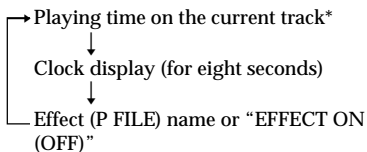

* May not appear with still images, etc.

During Normal Play

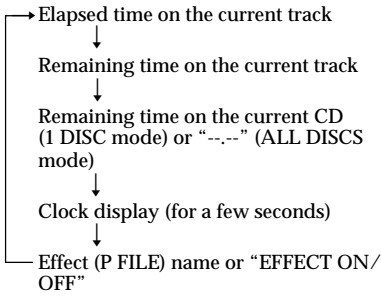

In stop mode

In the program mode when there is a program

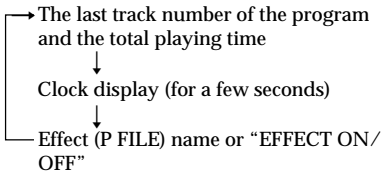

In other conditions

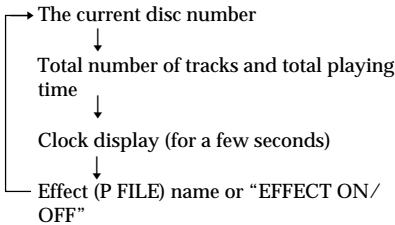

Tip

While playing a VIDEO CD without the PBC functions (Ver. 1.1) or audio CD, the current track number and playing time of the current track appear in the display.

Using the on-screen display

You can check the current operating status and disc information of VIDEO CDs or audio CDs during playback or in stop mode, superimposing a display on top of the video images on your TV screen.

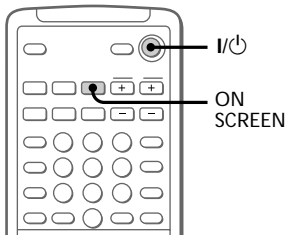

➔ Press ON SCREEN.

Each time you press this button, the on-screen display changes as follows:

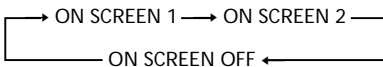

ON SCREEN 1 display

- During playback of an audio CD (except Program Play mode)

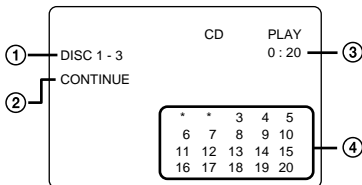

- ① Current disc and track number
- ② "PROGRAM"
- ③ Elapsed time of current track
- ④ Music calendar*

* The track numbers in the numerical calendar disappear after they are played.

- During playback of an audio CD in Program Play mode

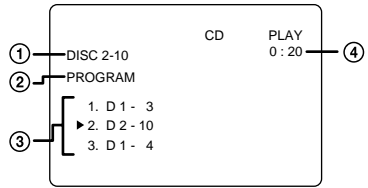

- ① Current disc and track number
- ② "PROGRAM"
- ③ Programmed disc and track numbers
- ④ Elapsed time of current track

- During stop mode of a VIDEO CD with the PBC functions

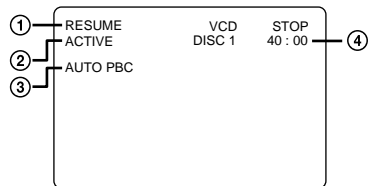

- ① "RESUME" or no display
- ② "ACTIVE" or no display
- ③ "AUTO PBC"
- ④ Total playing time of current disc

- During stop mode of a VIDEO CD or audio CD (except Program Play mode)

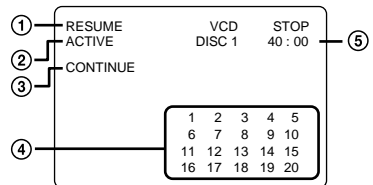

- ① "RESUME" or no display
- ② "ACTIVE"* or no display
- ③ Play mode
- ④ Music calendar
- ⑤ Total playing time of current CD

* For VIDEO CD only

- During stop mode of a VIDEO CD or audio CD in Program Play mode

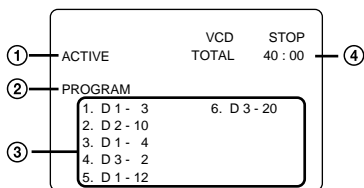

- 1 "ACTIVE"* or no display
- 2 "PROGRAM"
- 3 Programed disc and track numbers
- 4 Total playing time of program
- * For VIDEO CD only

ON SCREEN 2 display

- During playback of a VIDEO CD

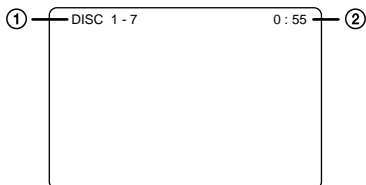

- 1 Current disc and track number*
- 2 Elapsed time of current track
- * "SCENE" and number appear during playback of a VIDEO CD with the PBC functions.

- During playback of an audio CD
Display is the same as ON SCREEN 1.

- During stop mode of a VIDEO CD (except Program Play mode)

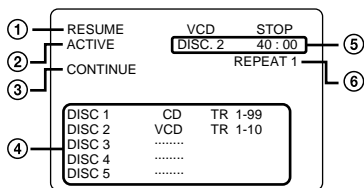

- 1 "RESUME" or no display
- 2 "ACTIVE" or no display
- 3 Play mode*
- 4 Total track numbers of each disc
- 5 Current disc number and total playing time of current disc
- 6 "REPEAT," "REPEAT 1," or no display
- * "AUTO PBC" appears for a VIDEO CD with the PBC functions.

- During stop mode of an audio CD (except Program Play mode)

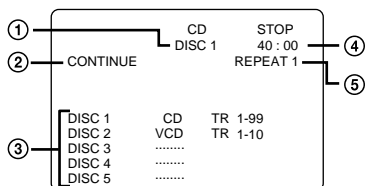

- 1 Current disc number
- 2 Play mode
- 3 Total track numbers of each disc*
- 4 Total playing time of current disc
- 5 "REPEAT," "REPEAT 1," or no display
- * Music calendar appears when SHUFFLE mode is selected.

- During stop mode of a VIDEO CD or audio CD in Program Play mode
Display is the same as ON SCREEN 1.

ON SCREEN OFF

No display (except for special menus).

Notes

- Normally, leave the display mode set to either ON SCREEN 1 or 2. When you select ON SCREEN OFF, you cannot check the operating status while operating the CD player. In this case, check the information on the front panel display.
- When you record video signals played back from this system onto a video tape (etc.), be sure to select ON SCREEN OFF. Otherwise, the display information will also be recorded on the video tape.

Locating a specific part of a disc

— Special Menu

This player has 4 different search features. Select the desired search feature from the SPECIAL MENU.

The TV screen must be ON to use these functions.

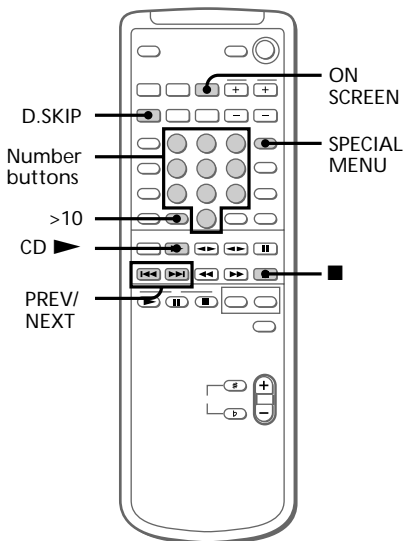

Locating by Scene Number

— Scene Search

On VIDEO CDs with the PBC functions (Ver. 2.0), the menu screens, moving pictures, and still pictures are divided into “scenes” and each scene has an assigned scene number. This function lets you start playback from a specific scene.

1 Start playing a VIDEO CD with the PBC functions (Ver. 2.0).

2 Press SPECIAL MENU.

3 Press 1 to select “1) SCENE SEARCH.”
“SCENE -” and the total number of scenes appear on the TV screen.

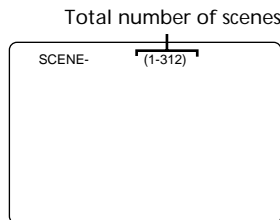

4 Press the number buttons (1 - 10/0) to select the desired scene.
To enter scene number 103:
Press 1 → 10/0 → 3. The selected scene number appears on the TV screen.

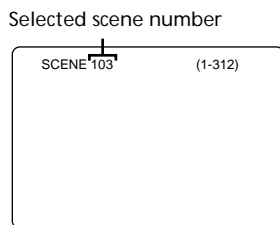

5 Press CD ►.
Playback starts from the selected scene.

To stop playback

Press ■.

To check the scene number during playback

Press ON SCREEN repeatedly to select the ON SCREEN 2 display mode. The scene number appears on the TV screen (see “Using the on-screen display” on page 24 for details).

Notes

- On some CDs, you may not be able to start playing from the scene you select because starting playback from certain scenes is prohibited.
In this case, play either starts from scene 1 (during stop mode) or continues from the current scene (during playback).
- Some CDs may not display the scene you select on the TV screen.
- When you select the ON SCREEN OFF display mode, no information is shown on the TV screen.

Locating by elapsed time

— Time Search

This function lets you use elapsed time as a guide in finding a certain parts of VIDEO CD without the PBC functions (Ver. 1.1).

“Elapsed time” means the time from the beginning of the disc. It is not the playing time of the current track as shown in the display.

It is especially useful when playing discs that have only a few track divisions.

This function cannot be used during playback of VIDEO CDs with the PBC functions (Ver. 2.0).

1 Press SPECIAL MENU.

2 Press 2 to select “2) TIME SEARCH.”

3 Press the number buttons (1 - 10/0) to enter the time (in minutes) for the desired section.

To enter 10 minutes: Press 1 → 10/0.

The selected elapsed time appears on the TV screen.

To reenter the time: Press CLEAR, and then press the number buttons again.

4 Press CD ►.
Playback starts from the selected time.

To stop playback

Press ■.

To use time search with VIDEO CDs with the PBC functions (Ver. 2.0)

Select “2) TIME SEARCH” before you start playing the VIDEO CD to disable the PBC functions.

Locating the desired track

— Disc Digest

You can select the desired track by viewing the first frame of each track. Either 9 or 12 different tracks can be displayed on the TV screen at one time.

This function cannot be used during playback of VIDEO CDs with the PBC functions (Ver. 2.0).

1 Press SPECIAL MENU.

2 Press 3 to select “3) DISC DIGEST.”
The first frame of tracks 1 through 9 (in default setting) on the current disc appear.

The sound of the first three seconds of each track on an audio CD plays, but there is no sound when using a VIDEO CD.

Current disc number

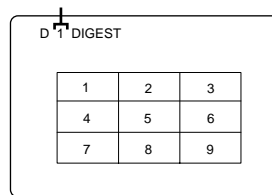

3 Press the number buttons (1 - 10/0) to select the desired track.

To stop playback

Press ■.

Locating a specific part of a disc (continued)

To switch to a 12 frame display

You can switch the digest display from 9 to 12 frames.

- 1 Press SPECIAL MENU.
- 2 Press 5.
- 3 Proceed with steps 1 and 2 of “Locating the desired track.” The first frame of tracks 1 through 12 appear.

To switch back to the 9 frame display, repeat this operation.

To display the next 9 or 12 tracks

Press NEXT. The first frame of tracks 10 through 18 (or 13 through 24) appear.

When there are more tracks in the disc, “▶▶” appears in the upper right corner of the TV screen.

To display previous tracks, press PREV.

To switch to the digest of another disc during disc digest

Press D. SKIP during disc digest.

To use disc digest with VIDEO CDs with the PBC functions (Ver. 2.0)

Select “3) DISC DIGEST” before you start playing the VIDEO CD to disable the PBC functions.

Tip

In step 2, you can select tracks even if they have not been displayed yet. Use the number buttons to select the desired track.

Notes

- Video images will not be shown for audio CDs.
- The play mode automatically switches to normal mode if you start disc digest during Shuffle or Program Play.

Locating a section within a track

— Track Digest

You can have the CD player divide a VIDEO CD track into either 9 or 12 different sections and display the first scene of each section on the TV screen. This might be useful when playing discs with few track divisions, such as movies.

This function cannot be used during playback of VIDEO CDs with the PBC functions (Ver. 2.0).

1 Start playing the desired VIDEO CD track.

2 Press SPECIAL MENU.

3 Press 4 to select “4) TRACK DIGEST.”

The current track is divided into 9 sections (in default setting) and the first frame of each section appears.

The sound of the first three seconds of each track on an audio CD plays, but there is no sound when using a VIDEO CD.

Current track number

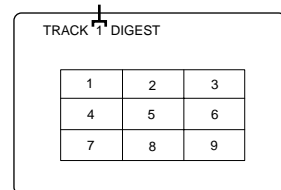

4 Press the number buttons to select the desired section.

Playback starts from a point near the selected frame.

To stop playback

Press ■.

To switch to a 12 frame display

You can switch the digest display from 9 to 12 frames.

- 1 Press SPECIAL MENU.
- 2 Press 5.
- 3 Proceed with steps 2 and 3 of "Locating a section within a track." The track is divided into 12 sections and the first frame of each section appears.

To switch back to the 9 frame display, repeat this operation.

To switch to the digest of another track during track digest

Press PREV or NEXT during track digest; however, this does not work during Shuffle Play or Program Play.

To use track digest with VIDEO CDs with the PBC functions (Ver. 2.0)

Select "4) TRACK DIGEST" before you start playing the VIDEO CD to disable the PBC functions.

Tip

In step 3, you can select sections even if they have not been displayed yet. Use the number buttons to select the desired track.

Note

Tracks less than 40 seconds long may be divided into fewer than 12 sections.

Resuming playback from the point you stopped a VIDEO CD

-- Resume Play

The system memorizes the point where you stopped the VIDEO CD so you can resume from that point. Resume play is not canceled when you turn off the system.

Note that resume play is not available when playing an audio CD.

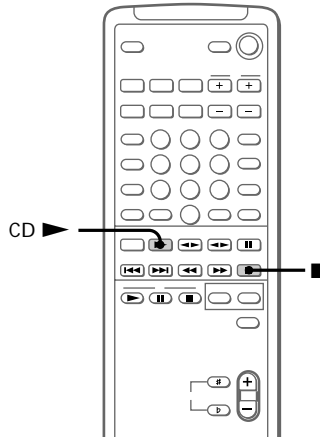
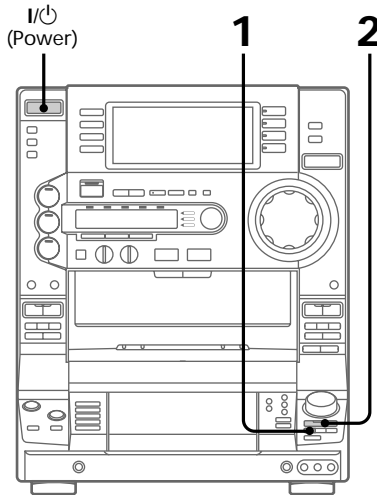

continued

Resuming playback from the point you stopped a VIDEO CD (continued)

- 1 While playing a VIDEO CD, press ■ to stop playback.
“RESUME” appears on your TV screen.
If “RESUME” does not appear, Resume Play is not available.
- 2 Press ▷|| (or CD ► on the remote).
The player starts playback from the point you stopped the VIDEO CD in step 1.

To view from the beginning of the VIDEO CD

When “RESUME” appears in the display, press ■, then press ▷|| (or CD ►).

Notes

- Resume Play is not available in the Digest, Shuffle, or Program Play modes.
- Depending on where you stopped the VIDEO CD, the player may resume playback from a different point.
- The point at which you stopped playback is cleared when:
 - you press number buttons, PLAY MODE, or ■.
 - you press DISC SKIP (or D.SKIP on the remote).
 - you press SPECIAL MENU.
 - you turn the jog dial.
 - you remove the VIDEO CD.
 - you unplug the system’s AC power cord.

Setting the sharpness

-- Active Picture

This function emphasizes the outline of the picture to create a sharper image.

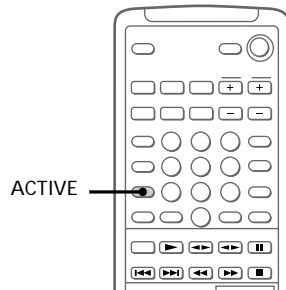
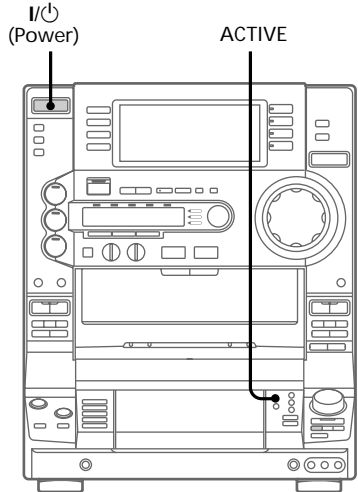

➔ Press ACTIVE so “ACTIVE PICTURE” appears in the display.

To cancel

Press ACTIVE again to display “ACTIVE OFF.”

Notes

- The active picture function is not available when playing audio CDs.
- “ACTIVE OFF” is selected automatically when you turn the system off.

Playing CD tracks repeatedly

— Repeat Play

This function lets you repeat a single CD or all CDs in Normal Play, Shuffle Play, and Program Play.

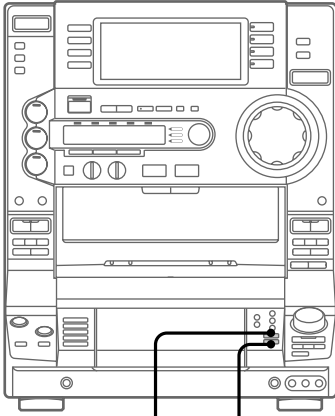

PLAY MODE REPEAT

➔ Press REPEAT repeatedly during playback until “REPEAT” appears in the display.

Repeat Play starts. The following table describes the various repeat modes.

To repeat	Press
All the tracks on the current CD	PLAY MODE repeatedly until “1 DISC” appears in the display.
All the tracks on all CDs	PLAY MODE repeatedly until “ALL DISCS” appears in the display.
Only one track	REPEAT repeatedly while playing the track you want to repeat until “REPEAT 1” appears in the display.

To cancel Repeat Play

Press REPEAT repeatedly until “REPEAT” or “REPEAT 1” disappears from the display.

Playing CD tracks in random order

— Shuffle Play

You can play all the tracks on one or all CDs in random order.

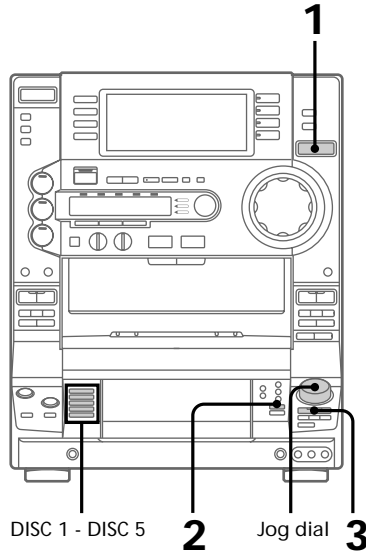

DISC 1 - DISC 5

Jog dial

1 Press FUNCTION repeatedly until “CD” appears in the display.

2 Press PLAY MODE repeatedly until “ALL DISCS SHUFFLE” or “1 DISC SHUFFLE” appears in the display. “ALL DISCS SHUFFLE” shuffles the tracks on all the CDs in the player. “1 DISC SHUFFLE” shuffles the tracks on the CD in the playing position.

3 Press ▷||. All the tracks play in random order.

Playing CD tracks in random order (continued)

To cancel Shuffle Play

Press PLAY MODE repeatedly until "ALL DISCS SHUFFLE," "1 DISC SHUFFLE," or "PROGRAM" disappears from the display. The tracks continue playing in their original order.

To select the desired CD

Press one of the DISC 1 - DISC 5 buttons during 1 Disc Shuffle Play.

Tips

- You can start Shuffle Play during Normal Play by pressing PLAY MODE repeatedly until "ALL DISCS SHUFFLE" or "1 DISC SHUFFLE" appears in the display.
- To skip a track, turn the jog dial clockwise (or press ►► on the remote).

Programming CD tracks

— Program Play

You can create a program of up to 32 tracks from all the CDs in the order you want them to be played.

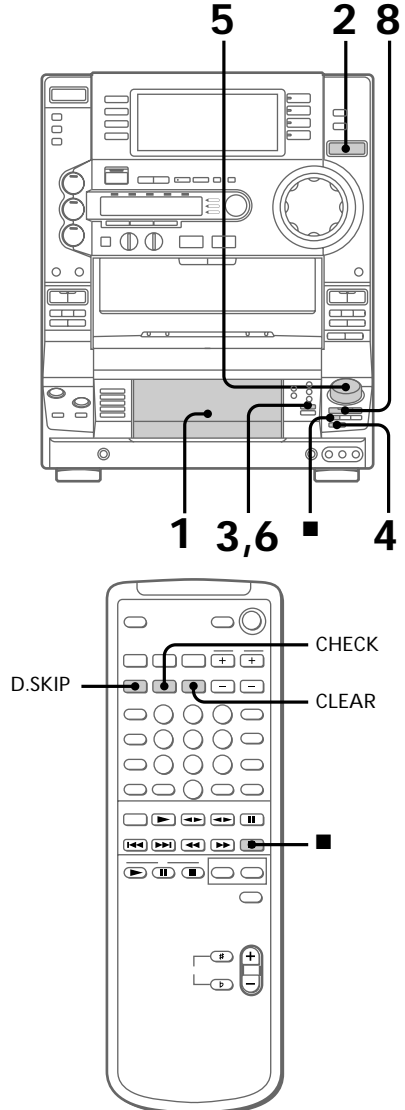

- 1** Place CDs and close the front cover.
- 2** Press FUNCTION repeatedly until "CD" appears in the display.
- 3** Press PLAY MODE repeatedly until "PROGRAM" appears in the display.
- 4** Press DISC SKIP to select a CD.
- 5** Turn the jog dial until the desired track appears in the display.

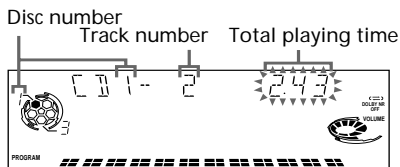

- 6** Press PLAY MODE once.
The track is programmed. First "STEP" and the programmed playing order appear, then the total playing time appears.

The last programmed track Total playing time

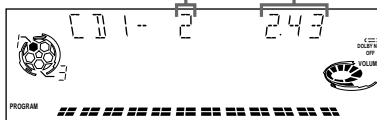

- 7** Repeat steps 4 through 6 to program additional tracks.

Skip step 4 to select tracks from the same disc.

- 8** Press .
All the tracks play in the order you selected.

Programming CD tracks (continued)

To cancel Program Play

Press PLAY MODE repeatedly until "PROGRAM," "ALL DISCS SHUFFLE," or "1 DISC SHUFFLE" disappears from the display.

To	Press
Check the program	CHECK on the remote repeatedly. After the last track, "CHECK END" appears.
Clear the last selected track	CLEAR on the remote in stop mode.
Clear a specific track	CHECK on the remote repeatedly until the number of the track to be cleared lights up, then press CLEAR.
Add a track to the program	1 Press DISC SKIP to select a CD. 2 Turn the jog dial to select a track. 3 Press PLAY MODE.
Clear the entire program	■ once in stop mode or twice while playing.

Tips

- The program you created remains in the CD player's memory even after it has been played. Press ▷|| to play the same program again.
- If "--:--" appears instead of the total playing time while programming, this means:
 - you have programmed a track numbered over 20, or
 - the total playing time has exceeded 100 minutes.

Playing CDs without interruption

-- Non-Stop Play

You can play CDs without pausing between tracks.

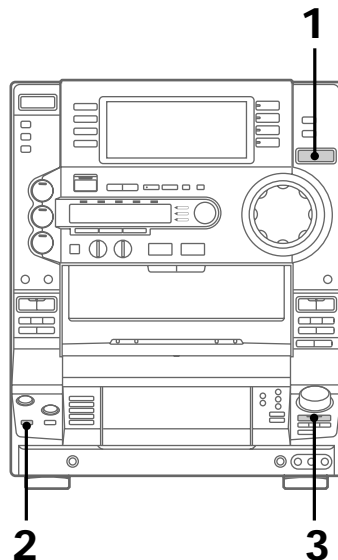

- 1 Press FUNCTION repeatedly until "CD" appears in the display.
- 2 Press NON-STOP so the indicator lights up.
- 3 Press ▷||.

To cancel Non-Stop Play

Press NON-STOP so that the indicator goes off.

Recording on a tape manually

You can record from CDs, tapes, or the radio. For example, you can record just the desired songs or begin recording from the middle of a tape. The recording level is automatically adjusted.

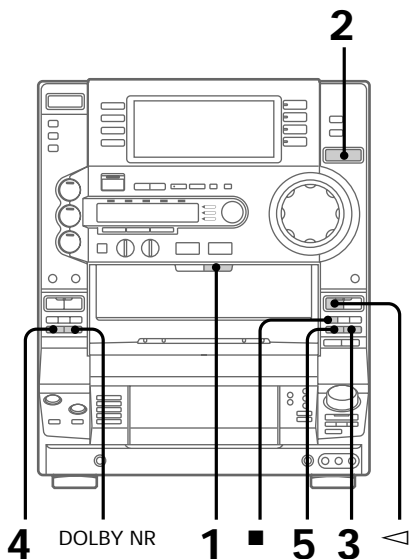

- 1** Press **▲ B EJECT** and insert a recordable tape into deck B.
- 2** Press **FUNCTION** repeatedly until the source you want to record (e.g., CD) appears in the display.
- 3** Press **● REC**.
Deck B stands by for recording, and the indicator on the **▷** button (for the front side) lights up green.
- 4** Press **DIRECTION** repeatedly until **↔** appears to record on one side or **↔↔** (or RELAY) to record on both sides.

- 5** Press **⏏**.
Recording starts.

- 6** Start playing the source to be recorded.

To	Press
Stop recording	■ on deck B
Pause recording	⏏

Tips

- When you want to record on the reverse side, press **◀** after pressing **● REC** in step 3 so that the indicator on the **◀** button (for the reverse side) lights up green.
- When you want to reduce the hiss noise in low-level, high-frequency signals, press **DOLBY NR** before step 5 so that "DOLBY NR B" appears in the display.

Recording CDs by specifying the track order

— Program Edit

You can record tracks from all the CDs in the order you want. When programming, make sure the playing times for each side do not exceed the length of one side of the tape.

This function cannot be used during playback of VIDEO CDs with the PBC functions (Ver. 2.0).

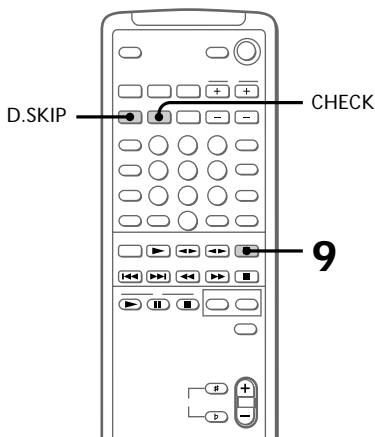
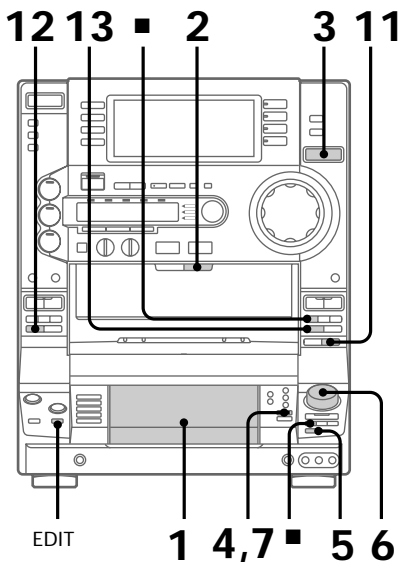

- 1 Place CDs and close the front cover.
- 2 Press **▲ B EJECT** and insert a recordable tape into deck B.
- 3 Press **FUNCTION** repeatedly until "CD" appears in the display.
- 4 Press **PLAY MODE** repeatedly until "PROGRAM" appears in the display.
- 5 Press **DISC SKIP** (or **D. SKIP** on the remote) to select a CD.
- 6 Turn the jog dial until the desired track appears in the display.

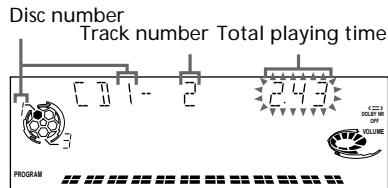

- 7 Press **PLAY MODE** once. The track is programmed. First "STEP" and the programmed playing order appear, then the total playing time appears.

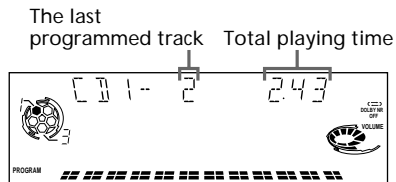

8 Repeat steps 5 through 7 to program additional tracks to be recorded on side A.

Skip step 5 to select tracks from the same disc.

9 Press **II** on the remote to insert a pause at the end of side A.
“P” appears in the display and the total playing time resets to “0.00” in the display.

10 Repeat steps 5 through 7 to program the tracks to be recorded on side B.
Skip step 5 to select tracks from the same disc.

11 Press CD SYNC.
Deck B stands by for recording, the CD player stands by for playback, and the indicator on the \triangleright button (for the front side) lights up green.

12 Press DIRECTION repeatedly until \rightleftarrows appears to record on one side, or \rightleftarrows (or RELAY) to record on both sides.

13 Press **II**.
Recording starts.

To stop recording

Press **■** on deck B or on the CD player.

To check the order

Press CHECK on the remote repeatedly. After the last track, “CHECK END” appears.

To cancel Program Edit

Press PLAY MODE repeatedly until “PROGRAM,” “ALL DISCS SHUFFLE,” or “1 DISC SHUFFLE” disappears from the display.

Selecting the tape length automatically

— Tape Select Edit

You can check the most suitable tape length for recording a CD. Note that you cannot use Tape Select Edit for discs containing more than 20 tracks.

➔ After inserting a CD, press EDIT once so that “EDIT” flashes.

First the required tape length for the CD in the playing position appears, then the total playing time for sides A and B appears.

Note

You cannot use this function when Program Play mode has been set. After clearing the entire program, follow the above procedure (see “Clear the entire program” in the table on page 34).

Looping part of a CD

— CD Loop

With the Loop function, you can repeat part of a CD during playback. This lets you create original recordings.

You cannot use this function with VIDEO CDs.

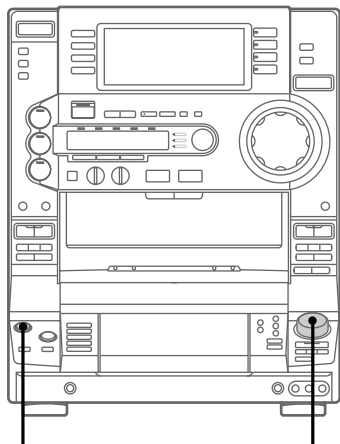

CD LOOP

Jog dial

➔ Press and hold CD LOOP during playback at the point you want to start the Loop function, and release to resume normal playback.

To adjust the loop length

Turn the jog dial while holding CD LOOP (or press FILE SELECT ▲/▼ while holding LOOP on the remote) to select different loop lengths.

Flashing part of a CD

— CD Flash

With the Flash function, you can “flash” the CD sound during playback. This lets you create original recordings.

You cannot use this function with VIDEO CDs.

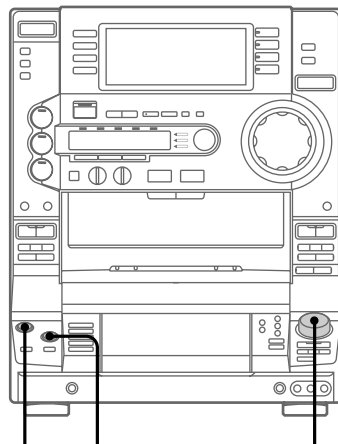

CD LOOP CD FLASH

Jog dial

➔ Press and hold CD FLASH during playback at the point you want to start the Flash function, and release to resume normal playback.

To adjust the flash length

Turn the jog dial while holding CD FLASH (or press FILE SELECT ▲/▼ while holding FLASH on the remote) to select different flash lengths.

To use CD LOOP and CD FLASH together

Press and hold both CD LOOP and CD FLASH (or LOOP and FLASH on the remote) at the same time.

Note

The loop and flash length cannot be adjusted in stop mode. Adjust the loop and flash lengths during playback.

Adjusting the sound

You can create a more powerful sound and listen with headphones.

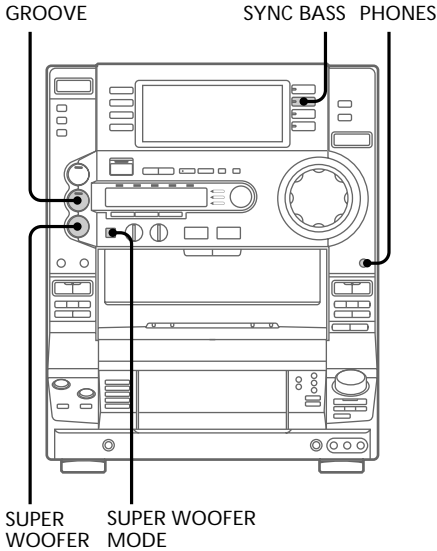

To reinforce the bass from the super woofer (SUPER WOOFER)

Press SUPER WOOFER.

Each time you press this button, the super woofer level display changes as follows:

SUPER WOOFER FLAT → LOW → HIGH

To select the super woofer mode

Press SUPER WOOFER MODE while the super woofer is on.

Each time you press this button, the super woofer mode display changes as follows:

MODE MOVIE ↔ MODE MUSIC

For a powerful sound (GROOVE)

Press GROOVE.

The volume switches to power mode, the sound effect changes, the super woofer level changes to "HIGH," and the indicator on the GROOVE button lights up. Press GROOVE again to return to the previous volume.

Note

Canceling the Groove mode cancels the equalizer curve and super woofer level.

For the most suitable bass sound (SYNC BASS)

Press SYNC BASS.

The bass frequencies of the music you are listening to are measured and those areas with heavy bass tones are effectively reinforced. The indicator on the SYNC BASS button flashes while measuring. Once measured, the indicator stops flashing and remains lit. Press SYNC BASS again to return to the previous level.

Notes

- The super woofer mode changes to MODE MUSIC in the SYNC BASS (Synchronized Bass) mode.
- If you press SUPER WOOFER MODE in the SYNC BASS mode, this mode is canceled and the super woofer mode changes to MODE MOVIE.
- You can change the super woofer level to LOW or HIGH in the SYNC BASS mode. However, if you change the level to SUPER WOOFER FLAT, the SYNC BASS mode is canceled.

To listen through the headphones

Connect the headphones to the PHONES jack.

No sound will come from the speakers.

Selecting the audio emphasis

The audio emphasis menu lets you select the sound characteristics according to the music you are listening to.

You can also enjoy the audio emphasis using the Synchronized Equalizer function. When using this function, the system automatically switches the equalizer according to the genre of the music.

The Personal File function (see “Making a personal audio emphasis file (Personal File)” on page 43) lets you store your own effects.

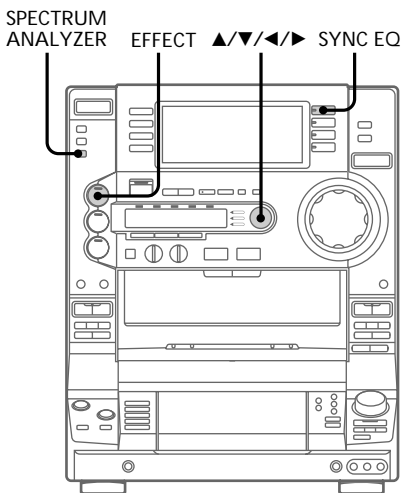

➔ Press ▲/▼ to select MENU 1 or MENU 2, then press ◀/▶ to select the desired audio emphasis.

See the chart “Music menu options” on this page. The audio emphasis name appears in the display.

When using the remote, press FILE SELECT ▲/▼ repeatedly until the desired audio emphasis name appears.

To cancel the audio emphasis

Press EFFECT (or FILE SELECT ON/OFF on the remote) repeatedly so that the indicator on the EFFECT button goes off.

Music menu options

“SUR(|||||)” appears if you select an audio emphasis with a surround effect.

Press	To select	
▲/▼	MENU 1	MENU 2
◀/▶	ROCK	MOVIE
	POP	GAME
	JAZZ	NIGHT
	DANCE	PARTY
	SALSA	RELAX

Using the Synchronized Equalizer function

You can set the audio emphasis to change automatically according to the beat and tempo of the music.

➔ Press SYNC EQ.

The indicator on the SYNC EQ button flashes while measuring the beat and tempo of the source. Once measured, the indicator stops flashing and remains lit.

SYNC EQ classifies the music source as follows:

Beat Density	LO (Low) HI (High)
Beat Strength	SMOOTH MEDIUM STRONG

To cancel the Synchronized Equalizer function

Press SYNC EQ again so that the indicator goes off.

The Synchronized Equalizer function is canceled also when:

- you cancel the audio emphasis.
- you reselect the audio emphasis from the music menu.
- you activate the surround effect.
- you adjust the graphic equalizer.
- you sing along (KARAOKE).

Notes

- The Synchronized Equalizer function does not work in KARAOKE mode.
- P FILE MEMORY does not work in this mode.
- The classification is not related to the genre of the music source.

Changing the equalizer display

You can change the equalizer display according to the music you are listening to.

-
- ➔ Press SPECTRUM ANALYZER.
Every time you press this button, the display changes as follows:
IMAGE PATTERN ↔ NORMAL PATTERN
-

To cancel the display pattern

Press SPECTRUM ANALYZER again. The display changes to show the equalizer curve.

Adjusting the audio emphasis

You can adjust the audio emphasis using the graphic equalizer and surround effect.

Adjusting the graphic equalizer

You can adjust the sound by raising or lowering the levels of specific frequency ranges.

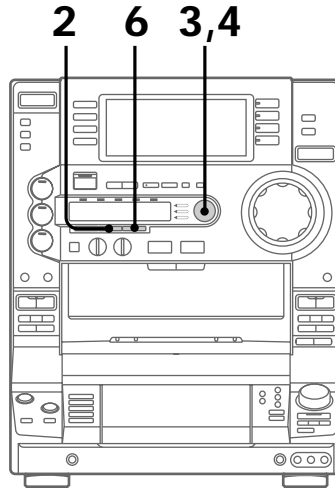

-
- 1** Select the desired basic audio emphasis for your sound (see “Selecting the audio emphasis” on page 40).
-

- 2** Press GEQ CTRL.
The frequency range appears and the level value flashes in the display.

Adjusting the audio emphasis (continued)

- Press ◀/▶ repeatedly to select a frequency band.

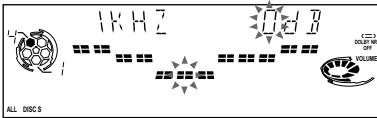

- Press ▲/▼ to adjust the level.

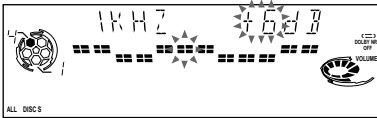

- Repeat steps 3 and 4 to adjust the other frequency bands.

- Press ENTER when finished.

Note

If you choose another audio emphasis (other than "EFFECT OFF"), the adjusted sound effect is lost. To retain the adjusted sound effect for future use, store it in a personal file (see "Making a personal audio emphasis file" on page 43).

Activating the surround effect

You can enjoy the surround effect.

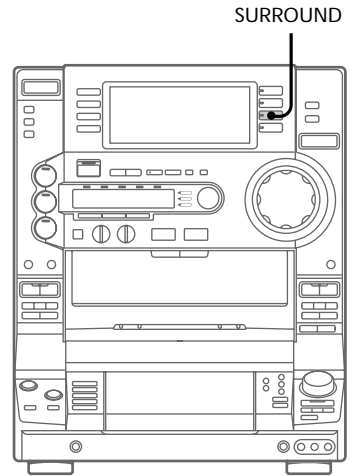

- Press SURROUND so that "SUR (|||||■||||)" appears in the display. Every time you press this button, the display changes as follows:
SURROUND ON ↔ SURROUND OFF

Note

If you choose other sound effects, the surround effect will be canceled. To retain the effect, store it in a personal file (see "Making a personal audio emphasis file" on page 43).

Making a personal audio emphasis file

— Personal File

You can create personal files of audio patterns (surround effect and graphic equalizer) and store them in the system's memory. Later, you can call up an audio pattern when playing a favorite tape, CD, or radio program. You can create up to five audio files. Before operation, first select the basic audio emphasis you want for your sound.

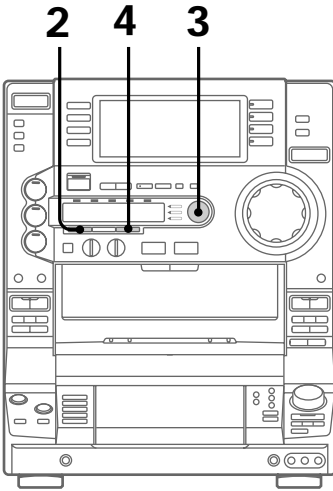

-
- 1** Create the desired sound effect by using the graphic equalizer and/or surround effect (see “Adjusting the audio emphasis” on page 41).

-
- 2** Press **P** FILE MEMORY.
A personal file number appears in the display.



-
- 3** Press **◀/▶** to select the file number (P FILE) where you want to store the sound effect.

-
- 4** Press **ENTER**.
The adjusted sound effects are stored under the selected file number. Any settings previously stored at this memory location are erased and replaced by the new settings.

To call up the personal file

Press **▲/▼** repeatedly to display the last selected personal file, then press **◀/▶** repeatedly to select the desired personal file. When using the remote, press **FILE SELECT** **▲/▼** repeatedly.

Singing along: Karaoke

You can sing along with any stereo CD or tape by turning down the singer's voice. You need to connect an optional microphone.

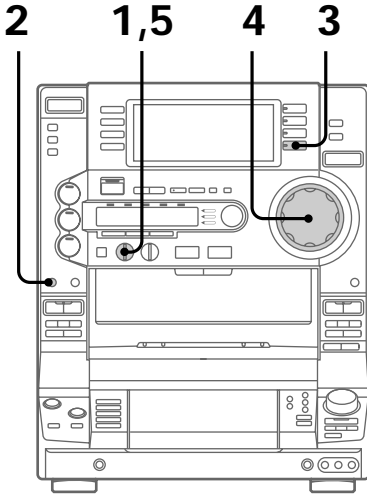

- 1** Turn MIC LEVEL to MIN to turn down the microphone level.
- 2** Connect an optional microphone to the MIC 1 or MIC 2.
- 3** Press KARAOKE PON/MPX repeatedly to obtain the karaoke effect.

Each time you press this button, the display changes as follows:

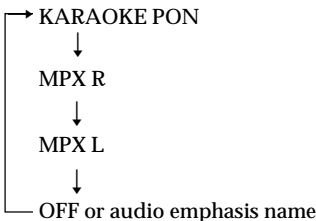

“🎤” appears in the display when the karaoke mode is activated.

To	Select
Reduce the singer's voice on a CD or tape	KARAOKE PON
Reduce the left channel on a multiplex CD or tape	MPX R
Reduce the right channel on a multiplex CD or tape	MPX L

- 4** Start playing the music and adjust the volume.
- 5** Turn MIC LEVEL to adjust the microphone volume.

When you use VIDEO CDs

Turn on your TV and switch it to the appropriate video input.

Refer to the operating instructions supplied with your TV for details.

When you are done

Turn MIC LEVEL to MIN and disconnect the microphone from MIC 1 or MIC 2, then press KARAOKE PON/MPX repeatedly until “🎤” disappears from the display.

Tip

You can use two microphones by connecting to MIC 1 and MIC 2 at the same time.

Note

With some songs, vocals may not be canceled when you select KARAOKE PON.

Adjusting the microphone echo

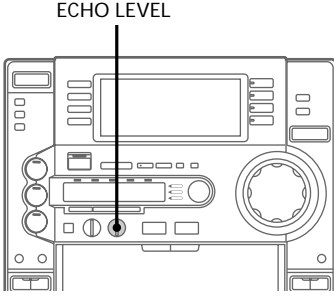

➔ Turn ECHO LEVEL to adjust the echo effect.

To cancel the echoing

Turn ECHO LEVEL to MIN.

Adjusting the key

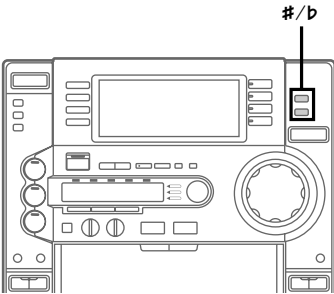

➔ Press **b** or **#**.
You can adjust the key higher or lower in 13 halftone steps (**b6** to **#6**).

To return to the original key

Press **b** and **#** at the same time.

Note

This function can be used with the CD player only.

Mixing and recording sounds

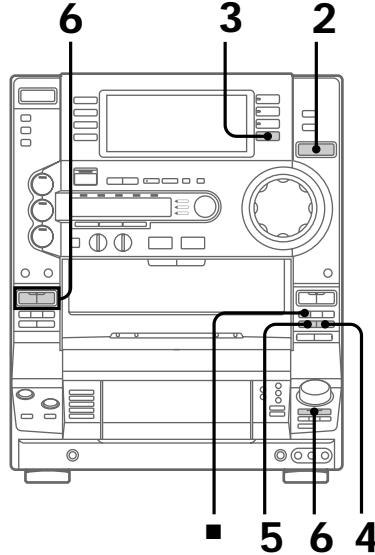

- 1 Prepare the microphone . Then, insert a recordable tape in deck B.
- 2 Press FUNCTION repeatedly to select the source you desire and set it to pause mode.
- 3 Press KARAOKE PON/MPX to activate the karaoke mode.
- 4 Press ● REC.
- 5 Press II.
- 6 Press ▷II to start playing the CD (or ▷ on deck A to start playing the tape).
Playback starts.
Start singing along with the music.

Singing along: Karaoke (continued)

To stop recording

Press ■ on deck B.

Tips

- If acoustic feedback (howling) occurs, move the microphone away from the speakers or change the direction of the microphone.
- If you want to record your voice through the microphone only, you can do so by selecting CD as the source but not playing a CD.
- When high level sound signals are input, the system automatically adjusts the recording level to prevent distortion of the recorded sound signal (Auto Level Control function).

Notes

- If you press EFFECT or select a sound effect, the karaoke mode is canceled.
- The instrumental sound may be reduced as well as the singer's voice when the source sound was recorded monaurally.
- The singer's voice may not be reduced when:
 - only a few instruments are playing.
 - a duet is being sung.
 - the source has strong echoes or chorus.
 - the singer's voice deviates from the center.
 - the voice on the source is singing high soprano or tenor notes.

Falling asleep to music

— Sleep Timer

You can set the system to turn off at a preset time, so you can fall asleep listening to music. You can preset the time in 10 minute increments.

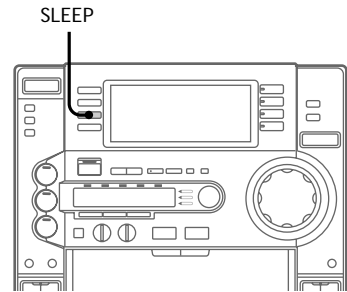

➔ Press SLEEP.

Each time you press this button, the minutes display (the remaining time) changes as follows:

AUTO → 90MIN → 80MIN → 70MIN
↑
OFF ← 10MIN 50MIN ← 60MIN
↓

When you choose AUTO

The system turns off when the current CD or tape finishes playback (up to 100 minutes). The system turns off if you manually stop playing a CD or tape.

To check the remaining time

Press SLEEP once.

To change the remaining time

Press SLEEP repeatedly to select the desired time.

To cancel the Sleep Timer function

Press SLEEP repeatedly until "SLEEP OFF" appears in the display.

Waking up to music

— Daily Timer

You can wake up to music at a preset time everyday. Make sure you have set the clock (see “Step 2: Setting the time” on page 7).

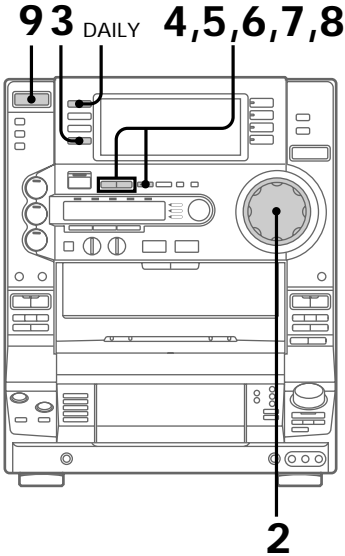

1 Prepare the music source you want to play.

- CD: Insert a CD. To start from a specific track, create a program (see “Programming CD tracks” on page 32).
- Tape: Insert a tape with the side you want to play facing forward.
- Radio: Tune in a preset station (see “Step 3: Presetting radio stations” on page 8).

2 Turn VOLUME to adjust the volume.

3 Press \odot /CLOCK SET.
“SET” appears and “DAILY” flashes in the display.

4 Press TUNING +/- to select “DAILY,” then press ENTER/NEXT.
“ON” appears and the hour indication flashes in the display.

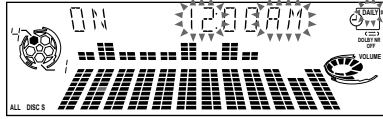

5 Set the time to start playback.
Press TUNING +/- to set the hour, then press ENTER/NEXT.
The minute indication flashes.

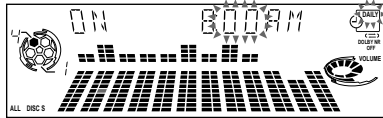

Press TUNING +/- to set the minutes, then press ENTER/NEXT.
The hour indication flashes again.

6 Set the time to stop playback following the above procedure.

Waking up to music (continued)

- 7** Press TUNING +/- until the desired music source appears.

The indication changes as follows:
TUNER → CD PLAY → TAPE PLAY



- 8** Press ENTER/NEXT.

The start time, the stop time, and the music source appear in turn before the original display returns.

- 9** Turn off the system.

To check the setting

- 1 Press DAILY.
“TIMER OFF” appears in the display.
- 2 Press DAILY again.
To change the setting, start over from step 1 on the previous page.

To cancel the timer operation

Press DAILY.
“TIMER OFF” appears in the display.

Notes

- The system turns on 15 seconds before the preset time.
- You cannot set the timer if the timer on and off times are the same.
- When you set the Sleep Timer, the Daily Timer will not turn on the system until the Sleep Timer turns it off.
- You cannot set the Daily Timer and Timer-recording to be activated at the same time.

Timer-recording radio programs

To timer-record, you must preset the radio station (see “Step 3: Presetting radio stations” on page 8) and set the clock (see “Step 2: Setting the time” on page 7) beforehand.

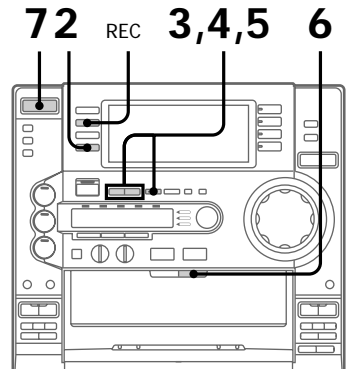

- 1 Tune in the preset radio station (see “Listening to the radio” on page 15).
- 2 Press ⊖/CLOCK SET.
“SET” appears and “DAILY” flashes in the display.
- 3 Press TUNING +/- to select “REC,” then press ENTER/NEXT.
“ON” appears and the hour indication flashes in the display.

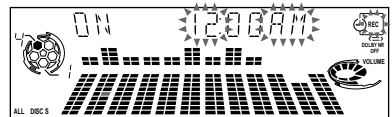

4 Set the time to start recording.

Press TUNING +/- to set the hour, then press ENTER/NEXT.

The minutes indication flashes.

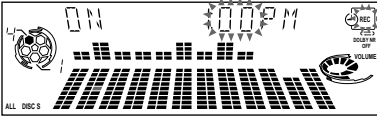

Press TUNING +/- to set the minutes, then press ENTER/NEXT.

The hour indication flashes again.

5 Set the time to stop recording following the above procedure.

The start time, the stop time, the recording source, and the preset station appear in turn before the original display returns.

6 Press ▲ B EJECT and insert a recordable tape in deck B.

7 Turn off the system.

When recording starts, the volume level is set to minimum.

- You cannot set the timer if the timer on and off times are the same.
- When you set the Sleep Timer, the Timer-recording will not start until the Sleep Timer turns off the system.
- You cannot set the Daily Timer and Timer-recording to be activated at the same time.
- Recording starts from the front side.

To check the setting

1 Press REC.

“TIMER OFF” appears in the display.

2 Press REC again.

To change the setting, start over from step 1 on the previous page.

To cancel the timer operation

Press REC.

“TIMER OFF” appears in the display.

Notes

- The system turns on 15 seconds before the preset time.
- If the system is on at the preset time, the Timer recording will not be made.

Connecting audio components

Connecting a turntable

Be sure to match the color of the plugs and the connectors. To listen to the sound from the connected turntable, press FUNCTION repeatedly until "PHONO" appears. Refer to the instructions included with your turntable for details.

To the audio outputs of the turntable

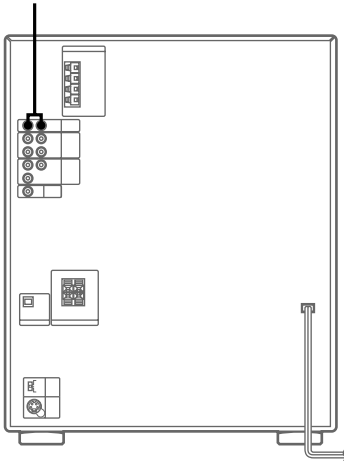

Note

Using the turntable at high volume may cause distortion or howling. This is often caused by the bass sound from the speakers. The bass sound may be picked up by the needle of the turntable, and produce the distortion or howling. To avoid this, do the following:

- 1 Keep some distance between the speakers and the turntable.
- 2 Stop using the surround effect.
- 3 Install the speakers or the turntable on a firm and stable surface.
- 4 Press SUPER WOOFER repeatedly until the indicator on this button goes off.

Connecting an MD deck for digital recording

You can record a CD to an MD digitally by connecting your MD deck using an optical cable. Refer to the instructions included with your MD deck for details.

To the digital input of the MD deck

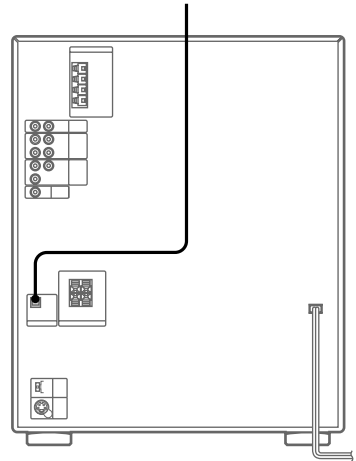

Note

You cannot record from a VIDEO CD to an MD deck digitally. When you record from a VIDEO CD to an MD deck, connect an optional audio cable to the audio output (see "Connecting an MD deck for analog recording" on page 51).

Connecting an MD deck for analog recording

Be sure to match the color of the plugs and the connectors. To listen to the sound of the connected MD deck, press FUNCTION repeatedly until "MD" appears. Refer to the instructions included with your MD deck for details.

To the audio outputs of the MD deck To the audio inputs of the MD deck

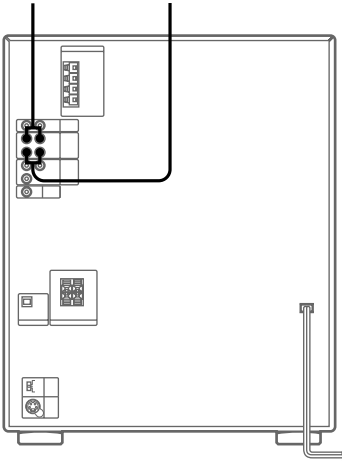

Tip

When you connect a Sony MD deck, you can use the MD ►, || and ■ buttons on this system's remote to perform play, pause and stop operation.

Connecting video components

You can connect a VCR, camcorder, or video game to the VIDEO 1 jack on the rear panel and/or the VIDEO 2 INPUT jack on the front panel.

Connecting a VCR

Be sure to match the color of the plugs and the connectors. To listen to the sound from the connected VCR, press FUNCTION repeatedly until "VIDEO 1" appears.

By connecting the audio output jacks of your VCR to the AUDIO IN jacks using an optional audio cable, you can enjoy video playback in powerful stereo sound. Moreover, if you connect the video input on the VCR to the MD OUT jacks and VIDEO OUT (or S VIDEO OUT) jack using the supplied video connecting cable (or an optional S VIDEO connecting cable), you can record the audio and video signals from a VIDEO CD onto video tape. Refer to the instructions included with your VCR for details.

To the audio inputs of the VCR To the audio outputs of the VCR

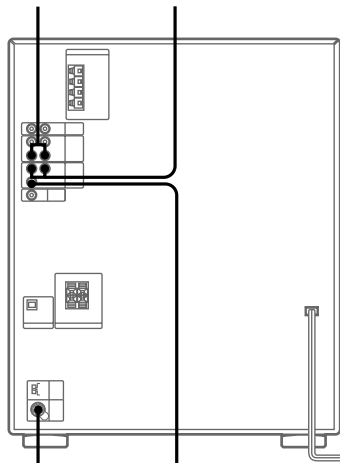

To the S VIDEO input of the VCR To the video output of the VCR

Note

The input signal from the VIDEO 1 and VIDEO 2 INPUT jacks do not output via the S VIDEO OUT jack.

continued

**Connecting video components
(continued)**

Connecting a camcorder or video game

Be sure to match the color of the plugs and the connectors. To listen to the sound from the connected camcorder or video game, press FUNCTION repeatedly until "VIDEO 2" appears.

Refer to the instructions included with each component for details.

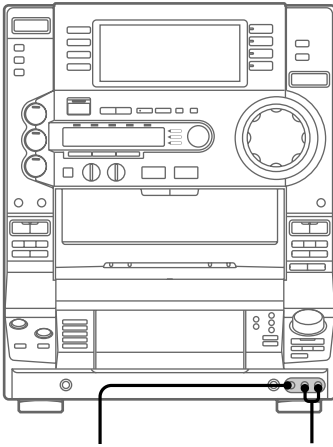

To the video output of the component

To the audio outputs of the component

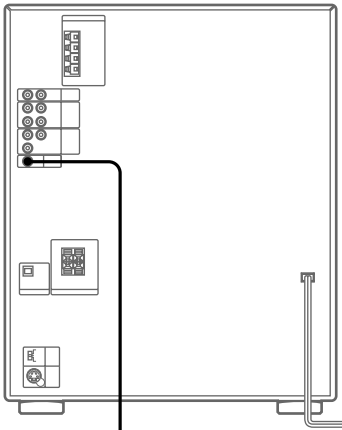

To the video input of the TV

Connecting outdoor antennas

Connect an outdoor antenna to improve the reception. Refer to the instructions of each component.

FM antenna

Connect an optional FM outdoor antenna. You can also use the TV antenna instead.

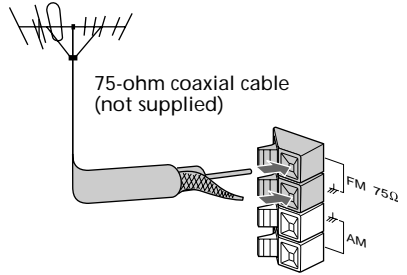

AM antenna

Connect a 6 to 15 meter insulated wire to the AM antenna terminal. Leave the supplied AM loop antenna connected.

Insulated wire (not supplied)

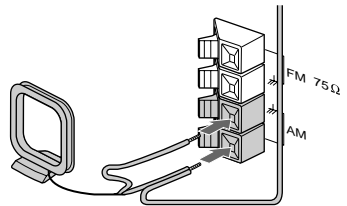

Important

If you connect an outdoor antenna, connect a ground wire to the ⚡ terminal with the screw clamp. To prevent a gas explosion, do not connect the ground wire to a gas pipe.

Precautions

On operating voltage

Before operating the system, check that the operating voltage of your system is identical with the voltage of your local power supply.

On safety

- The unit is not disconnected from the AC power source (mains) as long as it is connected to the wall outlet, even if the unit itself has been turned off.
- Unplug the system from the wall outlet (mains) if it is not to be used for an extended period of time. To disconnect the cord (mains lead), pull it out by the plug. Never pull the cord itself.
- Should any solid object or liquid fall into the component, unplug the stereo system and have the component checked by qualified personnel before operating it any further.
- The AC power cord must be changed only at a qualified service shop.

On placement

- Place the stereo system in a location with adequate ventilation to prevent heat build-up in the stereo system.
- Do not place the system in an inclined position.
- Do not place the system in locations where it is:
 - Extremely hot or cold
 - Dusty or dirty
 - Very humid
 - Subject to vibrations
 - Subject to direct sunlight

On operation

- If the stereo system is brought directly from a cold to a warm location, or is placed in a very damp room, moisture may condense on the lens inside the CD player. Should this occur, the system will not operate properly. Remove the CD and leave the system turned on for about an hour until the moisture evaporates.
- When you move the system, take out any discs.

If you have any questions or problems concerning your stereo system, please consult your nearest Sony dealer.

Notes on CDs

- Before playing, clean the CD with a cleaning cloth. Wipe the CD from the center out.
- Do not use solvents such as benzine, thinner, commercially available cleaners, or anti-static spray intended for vinyl LPs.
- Do not expose the CD to direct sunlight or heat sources such as hot air ducts, nor leave it in a car parked in direct sunlight.

Cleaning the cabinet

Use a soft cloth slightly moistened with mild detergent solution.

To save a tape permanently

To prevent a tape from being accidentally recorded over, break off the cassette tab from side A or B as illustrated.

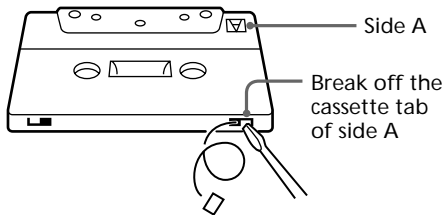
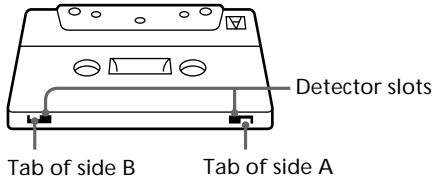

If you later want to reuse the tape for recording, cover the broken tab with adhesive tape. However, be careful not to cover the detector slots which allow the tape player to automatically detect the type of tape.

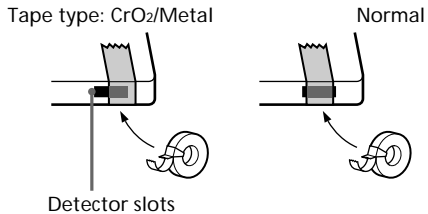

Precautions (continued)

Before placing a cassette in the tape deck

Take up any slack in the tape. Otherwise the tape may get entangled inside the tape deck and become damaged.

When using a tape longer than 90 minutes

The tape is very elastic. Do not frequently change the tape operations such as play, stop, and fast-forwarding, etc. The tape may get entangled in the tape deck.

Cleaning the tape heads

Clean the tape heads after every 10 hours of use.

When the tape heads become dirty

- the sound is distorted
- there is a decrease in sound level
- the sound drops out
- the tape does not erase completely
- the tape does not record

Make sure to clean the tape heads before you start an important recording or after playing an old tape. Use a separately sold dry-type or wet-type cleaning cassette. For details, refer to the instructions of the cleaning cassette.

Demagnetizing the tape heads

Demagnetize the tape heads and the metal parts that have contact with the tape every 20 to 30 hours of use with a separately sold demagnetizing cassette. For details, refer to the instructions of the demagnetizing cassette.

In case color irregularity is observed on nearby a TV screen

With the magnetically shielded type of speaker system, the speakers can be installed near a TV set. However, color irregularity may still be observed on the TV screen depending on the type of your TV set.

If color irregularity observed...

Turn off the TV set once, then turn it on after 15 to 30 minutes.

If color irregularity is observed again...

Place the speakers farther away from the TV set.

Troubleshooting

If you run into any problem using this stereo system, use the following checklist.

First, check that the power cord is connected firmly and that the speakers are connected correctly and firmly.

Should any problem persist, consult your nearest Sony dealer.

General

The display starts flashing as soon as you plug in the power cord even though you haven't turned on the system (demonstration mode).

- Press DEMO (STAND BY) while the system is off.

The demonstration appears automatically the first time you plug in the power cord, or if there is a power outage lasting longer than half a day.

The clock setting/radio presetting is canceled.

- The power cord is disconnected or a power failure occurs for more than half a day.

Redo the following procedures:

- “Step 2: Setting the time” on page 7.
- “Step 3: Presetting radio stations” on page 8.

To set the timer function again, also redo “Waking up to music” on page 47 and “Timer-recording radio programs” on page 48.

There is no sound.

- Turn VOLUME clockwise.
- The headphones are connected.
- Insert only the stripped portion of the speaker cord into the SPEAKER jack. Inserting the vinyl portion of the speaker cord will interfere with the speaker connection.
- The volume level is automatically set to the minimum during the Timer-recording.

There is no microphone sound.

- Turn VOLUME or MIC LEVEL to adjust the microphone volume.
- Make sure the microphone is connected to the MIC 1 or MIC 2 jack correctly.

There is severe hum or noise.

- A TV or VCR is placed too close to the stereo system. Move the stereo system away from the TV or VCR.

"12:00AM" flashes in the display.

- A power interruption occurred. Reset the clock and timer settings.

The timer does not function.

- Set the clock correctly.

DAILY and REC do not appear when you press /CLOCK SET.

- Set the timer correctly.
- Set the clock.

The remote does not function.

- There is an obstacle between the remote and the system.
- The remote is not pointing in the direction of the system's sensor.
- The batteries have run down. Replace the batteries.

There is acoustic feedback.

- Decrease the volume level.
- Move the microphone away from the speakers or change the direction of the microphone.

The color irregularity on a TV screen persists.

- Turn off the TV set once, then turn it on after 15 to 30 minutes. If the color irregularity still persists, place the speakers farther away from the TV set.

Speakers

There is no sound and "PUSH POWER" and "PROTECT" appear in the display alternately.

- Press  to turn off the system and check the speaker connections and placement.

Sound comes from only one channel or the left and right volumes are unbalanced.

- Check the speaker connections and placement.

VIDEO CD/CD Player

There is no picture.

- Check that the player is connected correctly and securely.
- Make sure you operate the TV correctly.
- Make sure you set the SYSTEM SELECT correctly, according to your TV (color) system.
- Press FUNCTION repeatedly until "CD" appears in the display.

An after image of the last picture remains on the screen, or the picture is unclear.

- Press ACTIVE repeatedly until "ACTIVE OFF" appears in the display.

The CD tray does not rotate.

- A CD is not placed properly.

A CD will not play.

- The CD is not lying flat in the disc tray.
- The CD is dirty.
- The CD is inserted label side down.
- Moisture condensation has built up. Remove the CD and leave the system turned on for about an hour until the moisture evaporates.

Play does not start from the first track.

- The player is in Program or Shuffle Play mode. Press PLAY MODE repeatedly until "PROGRAM," "ALL DISCS SHUFFLE," or "1 DISC SHUFFLE" disappears from the display.

Tape Deck

The tape does not record.

- No tape is in the cassette holder.
- The tab has been removed from the cassette (see page 53).
- The tape has reeled to the end.

The tape does not record nor play, or there is a decrease in sound level.

- The heads are dirty. Clean them (see page 54).
- The record/playback heads are magnetized. Demagnetize them (see page 54).

Troubleshooting (continued)

The tape does not erase completely.

- The record/playback heads are magnetized. Demagnetize them (see page 54).

There is excessive wow or flutter, or the sound drops out.

- The capstans or pinch rollers are dirty. Clean them (see page 54).

Noise increases or the high frequencies are missing.

- The record/playback heads are magnetized. Demagnetize them (see page 54).
-

Tuner

Severe hum or noise (“TUNED” or “STEREO” flashes in the display).

- Adjust the antenna.
- The signal strength is too weak. Connect an external antenna.

A stereo FM program cannot be received in stereo.

- Press STEREO/MONO so “STEREO” appears in the display.
-

If other problems not described above occur, reset the system as follows:

- 1 Unplug the power cord.
- 2 Plug the power cord back in.
- 3 Press \ominus /CLOCK SET, ENTER, and I/\cup at the same time.

The system is reset to the factory settings. All the settings you made, such as the preset stations, clock, and timer are cleared. You should set them again.

Specifications

Amplifier section

The following measured at AC 220 V, 50/60 Hz

DIN power output (Rated)

150 + 150 watts
(6 ohms at 1 kHz, DIN)

Continuous RMS power output (Reference)

200 + 200 watts
(6 ohms at 1 kHz, 10 % THD)

Inputs

PHONO IN (phono jacks): sensitivity 3 mV,
impedance 47 kilohms

MIC 1/2 (phono jack): sensitivity 1 mV,
impedance 10 kilohms

VIDEO 1 IN (phono jacks): sensitivity 250 mV,
impedance 47 kilohms

VIDEO 2 IN (phono jacks): sensitivity 250 mV,
impedance 47 kilohms

MD IN (phono jacks): sensitivity 450 mV,
impedance 47 kilohms

Outputs

PHONES (stereo phone jack):
accepts headphones of
8 ohms or more

VIDEO OUT (phono jack): voltage 250 mV,
impedance 1 kilohm

MD OUT (phono jacks): voltage 250 mV,
impedance 1 kilohm

FRONT SPEAKER : accepts impedance of 6 to
16 ohms

Video section

Inputs

VIDEO1 IN (phono jacks): 1 V p-p, 75 ohms

VIDEO2 IN (phono jacks): 1 V p-p, 75 ohms

Outputs

VIDEO OUT (phono jack): 1 V p-p, 75 ohms

S-VIDEO OUT (4-pin/mini-DIN jack):

Y: 1 V p-p, unbalanced,
Sync negative,
C: 0.286 V p-p,
load impedance 75 ohms

VIDEO CD/CD player section

System	Compact disc, digital audio and video system
Laser	Semiconductor laser ($\lambda = 780 \text{ nm}$), Emission duration : continuous
Laser output	Max. $44.6 \mu\text{W}^*$ * This output is the value measured at a distance of 200 mm from the objective lens surface on the Optical Pick-up Block with 7 mm aperture.
Wavelength	780 - 790 nm
Frequency Response	2 Hz - 20 kHz ($\pm 0.5 \text{ dB}$)
Signal-to-noise ratio	More than 90 dB
Dynamic range	More than 90 dB
CD DIGITAL OUT (square optical connector jack, rear panel)	
Video color system format	NTSC, PAL
Wave length:	660 nm
Output level:	-18 dBm

Tape player section

Recording system	4-track 2-channel stereo
Frequency Response (DOLBY NR OFF)	40 - 13,000 Hz ($\pm 3 \text{ dB}$), using a Sony TYPE I cassette 40 - 14,000 Hz ($\pm 3 \text{ dB}$), using a Sony TYPE II cassette
Wow and flutter	$\pm 0.15 \%$ W.Peak (IEC) 0.1 % W.RMS (NAB) $\pm 0.2 \%$ W.Peak (DIN)

Tuner section

FM Stereo, FM/AM superheterodyne tuner

FM tuner section

Tuning range	87.5 - 108.0 MHz (50 kHz step)
Antenna:	FM Wire antenna
Antenna terminals	75 ohm unbalanced
Intermediate frequency	10.7 MHz

AM tuner section

Tuning range	531 - 1,602 kHz (with the tuning interval set at 9 kHz) 530 - 1,701 kHz (with the tuning interval set at 10 kHz)
Antenna	AM loop antenna, External antenna terminals
Intermediate frequency	450 kHz

Speakers

SS-LV60R

Speaker System	3-way, 4-unit, bass-reflex type
Speaker units	
Woofer:	30 cm dia., cone type
Mid range:	10 cm dia., cone type $\times 2$
Tweeter:	5 cm dia., cone type
Rated impedance:	6 ohms
Dimensions(w/h/d)	Approx. $350 \times 855 \times 350 \text{ mm}$
Mass	Approx. 15 kg net per speaker

General

Power Requirements	220 V AC, 50/60 Hz
Power Consumption	180 watts
Dimensions(w/h/d)	Approx. $356 \times 423 \times 446$ incl. projecting parts and controls
Mass	Approx. 15.1 kg
Supplied Accessories	AM loop antenna (1) FM wire antenna (1) Speaker cords (2) Remote (1) R6(size AA) batteries (2) Video connecting cable (1)

Design and specifications are subject to change without notice.

Glossary

Auto Pause

An automatic pause function which is activated according to the signal encoded on the disc while playing a VIDEO CD. If the CD player does not resume play for a long time, press ▷|| to resume play manually.

Menu Playback

Playback using the menu screens recorded on VIDEO CDs with PBC functions. You can enjoy simple interactive software using the menu playback function.

Playback Control (PBC)

Signals encoded on VIDEO CDs (Version 2.0) to control playback.

By using menu screens recorded on VIDEO CDs with PBC functions, you can enjoy playing simple interactive software, software with search functions, and so on.

Track

Sections of a picture or a music piece on disc. Each track is assigned a track number to help you locate the desired track.

VIDEO CD

A compact disc which contains moving pictures.

VIDEO CDs contain compact picture information using the MPEG 1 format, one of the world wide standards of digital compact technology. The picture information is compressed about 120 times. Consequently, a 12 cm VIDEO CD can contain up to 74 minutes of moving pictures.

VIDEO CDs also contain compact audio information. Sounds outside the range of human hearing are compressed while the sounds we can hear are not compressed. VIDEO CDs can hold six times the audio information of conventional audio CDs.

There are two versions for VIDEO CDs; Version 1.1 (VIDEO CDs without PBC functions):

You can play only moving pictures and sounds.

Version 2.0 (VIDEO CDs with PBC functions):

You can play still pictures and enjoy PBC functions.

This player can play to both versions.

Index

A

- Active Picture 30
- Adjusting
 - the audio emphasis 41
 - the on-screen display 24
 - the sound 39
 - the volume 11, 16, 18
- AMS 13, 18
- Antennas 5, 52
- Audio emphasis 40, 41
- Automatic Source Selection 11, 13, 16, 19

B

- Batteries 6

C

- CD Flash 38
- CD Loop 38
- CD player 12, 22
- CD Synchro Recording 14
- Clock setting 7
- Connecting 4~6, 50~52

D, E, F, G

- Daily timer 47
- Digest
 - disc 27
 - track 28
- Display 22, 41
- Dubbing 19

H, I, J

- Hooking up
 - optional components 50
 - speakers 4
 - the antennas 5, 52
 - the power 6
 - the system 4

K, L

- Karaoke 44
 - adjusting the key 45
 - adjusting the microphone echo 45
 - to reduce the vocals (KARAOKE) 44
 - to sing along with a multiplex CD or tape (MPX R/MPX L) 44

M

- Microphone
 - mixing 45
- Mixing sound 45

N

- Non-Stop Play 34
- Normal Play 12

O

- One Touch Play 11, 13, 16, 19

P, Q

- Personal File 43
- Playing
 - a CD 12
 - a VIDEO CD 10
 - a preset radio station 15
 - a tape 18
 - tracks in random order (Shuffle Play) 31
 - tracks in the desired order (Program Play) 32
 - tracks repeatedly (Repeat Play) 31
 - without interruption 34
- Preset tuning 15
- Presetting radio stations 8
- Program Edit 36
- Program Play 32
- Protecting recordings 53

R

- Radio stations
 - presetting 8
 - tuning in 15
- Recording
 - a radio program 16
 - a VIDEO CD/CD 14
 - another tape (High-Speed dubbing) 19
 - CDs by specifying the track order 36
 - on a tape manually 35
 - selecting tape length automatically 37
 - timer-recording 48
- Repeat Play 31
- Resetting the system 56

S

- Saving recordings 53
- Selecting
 - the audio emphasis 40
 - the color system 5
- Setting the time 7
- Shuffle Play 31
- Sleep Timer 46
- Sound adjustment 39
- Speakers 4
- Surround effect 42
- SYNC BASS 39
- SYNC EQ 40

T, U

- Tape Select Edit 37
- Timer
 - falling asleep to music 46
 - timer-recording 48
 - waking up to music 47
- Troubleshooting 54
- Tuner 8, 15, 16
- Tuning interval 9
- Turntable 50

V, W, X, Y, Z

- VIDEO CD/CD Player 10

