

Home Theater System

Operating Instructions

GB

HT-K215



WARNING

To prevent fire or shock hazard, do not expose the unit to rain or moisture.

To avoid electrical shock, do not open the cabinet. Refer servicing to qualified personnel only.

Precautions

On safety

- Should any solid object or liquid fall into the cabinet, unplug the amplifier and have it checked by qualified personnel before operating it any further.

On power sources

- Before operating the amplifier, check that the operating voltage is identical with your local power supply. The operating voltage is indicated on the nameplate at the bottom of the amplifier.
- The amplifier is not disconnected from the AC power source (mains) as long as it is connected to the wall outlet, even if the amplifier itself has been turned off.
- If you are not going to use the amplifier for a long time, be sure to disconnect the amplifier from the wall outlet. To disconnect the mains lead, grasp the plug itself; never pull the cord.
- The AC power cord (mains lead) must be changed, at a qualified service shop only.
- The mains switch is located on the front exterior.

On placement

- Do not install the appliance in a confined space, such as a bookcase or built in cabinet.
- Place the amplifier in a location with adequate ventilation to prevent heat buildup and prolong the life of the amplifier.
- Do not place the amplifier near heat sources, or in a place subject to direct sunlight, excessive dust or mechanical shock.
- Do not place anything on top of the cabinet that might block the ventilation holes and cause malfunctions.
- Do not set the speakers in an inclined position.
- Do not place the speakers in locations that are:
 - Extremely hot or cold
 - Dusty or dirty
 - Very humid
 - Subject to vibrations
 - Subject to direct sunlight

On operation

- Before connecting other components, be sure to turn off and unplug the amplifier.
- Do not drive the speaker system with a continuous wattage exceeding the maximum input power of the system.
- If the polarity of the speaker connections are not correct, the bass tones will be weak and the position of the various instruments obscure.
- Contact between bare speaker wires at the speaker terminals may result in a short-circuit.
- The speaker grille cannot be removed. Do not attempt to remove the grille on the speaker system. If you try to remove it, you may damage the speaker.

If you encounter color irregularity on a nearby TV screen

This speaker system is magnetically shielded to allow it to be installed near a TV set. However, color irregularities may still be observed on certain types of TV sets.

If color irregularity is observed...

- Turn off the TV set once, then turn it on again after 15 to 30 minutes.

If color irregularity is observed again...

- Place the speakers further away from the TV set.

If howling occurs

Reposition the speakers or turn down the volume on the amplifier.

On cleaning

- Clean the cabinet, panel and controls with a soft cloth slightly moistened with a mild detergent solution. Do not use any type of abrasive pad, scouring powder or solvent such as alcohol or benzine.

If you have any question or problem concerning your amplifier, please consult your nearest Sony dealer.

About This Manual

Conventions

- The instructions in this manual describe the controls on the amplifier and speakers. You can also use the controls on the supplied remote if they have the same or similar names as those on the amplifier.
- The following icon is used in this manual:
🔦 Indicates hints and tips for making the task easier.

This amplifier incorporates Dolby* Digital and Pro Logic Surround and the DTS** Digital Surround System.

* *Manufactured under license from Dolby Laboratories. "Dolby", "AC-3", "Pro Logic" and the double-D symbol $\square\square$ are trademarks of Dolby Laboratories. Confidential unpublished Works. © 1992-1997 Dolby Laboratories. All rights reserved.*

***Manufactured under license from Digital Theater Systems, Inc. US Pat. No. 5,451,942 and other worldwide patents issued and pending. "DTS" and "DTS Digital Surround" are trademarks of Digital Theater Systems, Inc. © 1996 Digital Theater Systems, Inc. All rights reserved.*

Demonstration Mode

The demonstration will activate the first time you turn on the power. When the demonstration starts, the following message appears in the display :

"NOW DEMONSTRATION MODE IF YOU FINISH
DEMONSTRATION PLEASE PRESS POWER KEY
WHILE THIS MESSAGE APPEARS IN THE DISPLAY
THANK YOU"

To cancel the demonstration

Press I/⏻ to turn the amplifier off while the above message is being displayed. The next time you turn the amplifier on, the demonstration will not appear.

To view the demonstration

Hold down SET UP and press I/⏻ to turn on the power.

Notes

- Running the demonstration will clear the amplifier's memory. For details on what will be cleared, see "Clearing the amplifier's memory" on page 14.
- There will be no sound when the demonstration mode is activated.

TABLE OF CONTENTS

Hooking Up the Components 4

- Unpacking 4
- Setting Up the Amplifier 5
- Video Component Hookups 6
- Digital Component Hookups 7
- 5.1CH/SAT Hookups 8
- Other Hookups 9

Hooking Up and Setting Up the Speaker System 10

- Speaker System Hookup 11
- Performing Initial Setup Operations 14
- Multi Channel Surround Setup 15
- Before You Use Your Amplifier 20

Location of Parts and Basic Operations 21

- Front Panel Parts Descriptions 21

Enjoying Surround Sound 23

- Selecting a Sound Field 24
- Understanding the Multi-Channel Surround Displays 27
- Customizing Sound Fields 29

Other Operations 32

- Using the Sleep Timer 33

Additional Information 34

- Troubleshooting 34
- Specifications 36
- Glossary 38
- Settings Using SURR, LEVEL, and SET UP buttons 39
- Remote Button Description 40
- Index 42

GB

Hooking Up the Components

This chapter describes how to connect various audio and video components to the amplifier. Be sure to read the sections for the components you have before you actually connect them to the amplifier.

Unpacking

Check that you received the following items with the amplifier:

- Remote commander (remote) (1)
- Size AA (R6) batteries (2)
- Speakers
 - Front speakers (2)
 - Rear speakers (2)
 - Center speaker (1)
 - Subwoofer (1)
- Speaker connecting cord, long (2)
- Speaker connecting cord, short (3)
- Monaural connecting cord (1 phono to 1 phono) (1)
- Foot pads (20)
- Screw (1)
- Amplifier stand (1)

Inserting batteries into the remote

Insert R6 (size-AA) batteries with the + and – properly oriented in the battery compartment. When using the remote, point it at the remote sensor  on the amplifier.

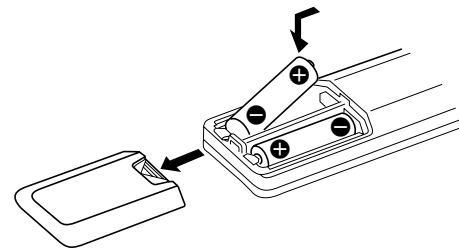

When to replace batteries

Under normal conditions, the batteries should last for about 6 months. When the remote no longer operates the amplifier, replace all batteries with new ones.

Notes

- Do not leave the remote in an extremely hot or humid place.
- Do not use a new battery with an old one.
- Do not expose the remote sensor to direct sunlight or lighting apparatuses. Doing so may cause a malfunction.
- If you don't use the remote for an extended period of time, remove the batteries to avoid possible damage from battery leakage and corrosion.

Before you get started

- Turn off the power to all components before making any connections.
- Do not connect the AC power cords until all of the connections are completed.
- Be sure to make connections firmly to avoid hum and noise.
- When connecting an audio cord, be sure to match the color-coded pins to the appropriate jacks on the components: white (left, audio) to white; and red (right, audio) to red.

Setting Up the Amplifier

You can place the amplifier flat on a surface or on the amplifier stand. Make sure that you do not place anything on top of the amplifier.

1 Turn the amplifier to its side.

Be sure to place the amplifier with the I/⏻ (power) button at the bottom.

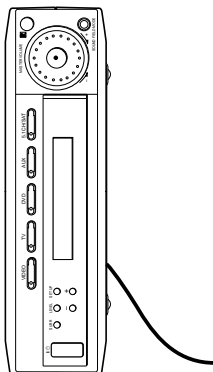

2 Place the amplifier stand on top of the amplifier.

Be sure to align the hole on the stand to the hole on the amplifier.

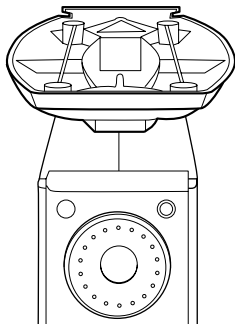

3 Press to insert the stand to the amplifier.

4 Insert the screw and tighten it.

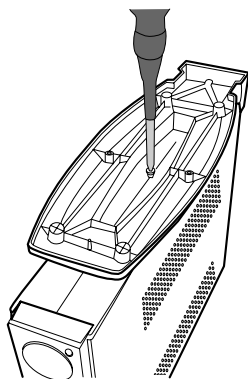

5 Place the amplifier stand on a flat surface.

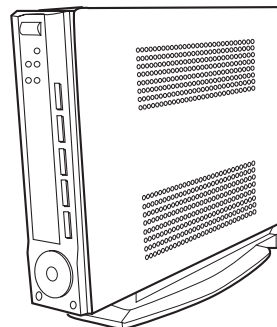

Note

You can dress the power cord and other wires at the amplifier stand as shown below.

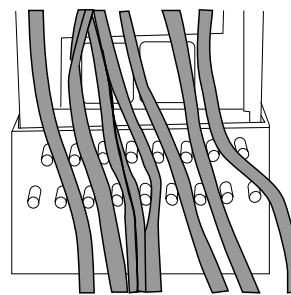

Video Component Hookups

Required cords

Audio cord (not supplied)

When connecting a cord, be sure to match the color-coded pins to the appropriate jacks on the components.

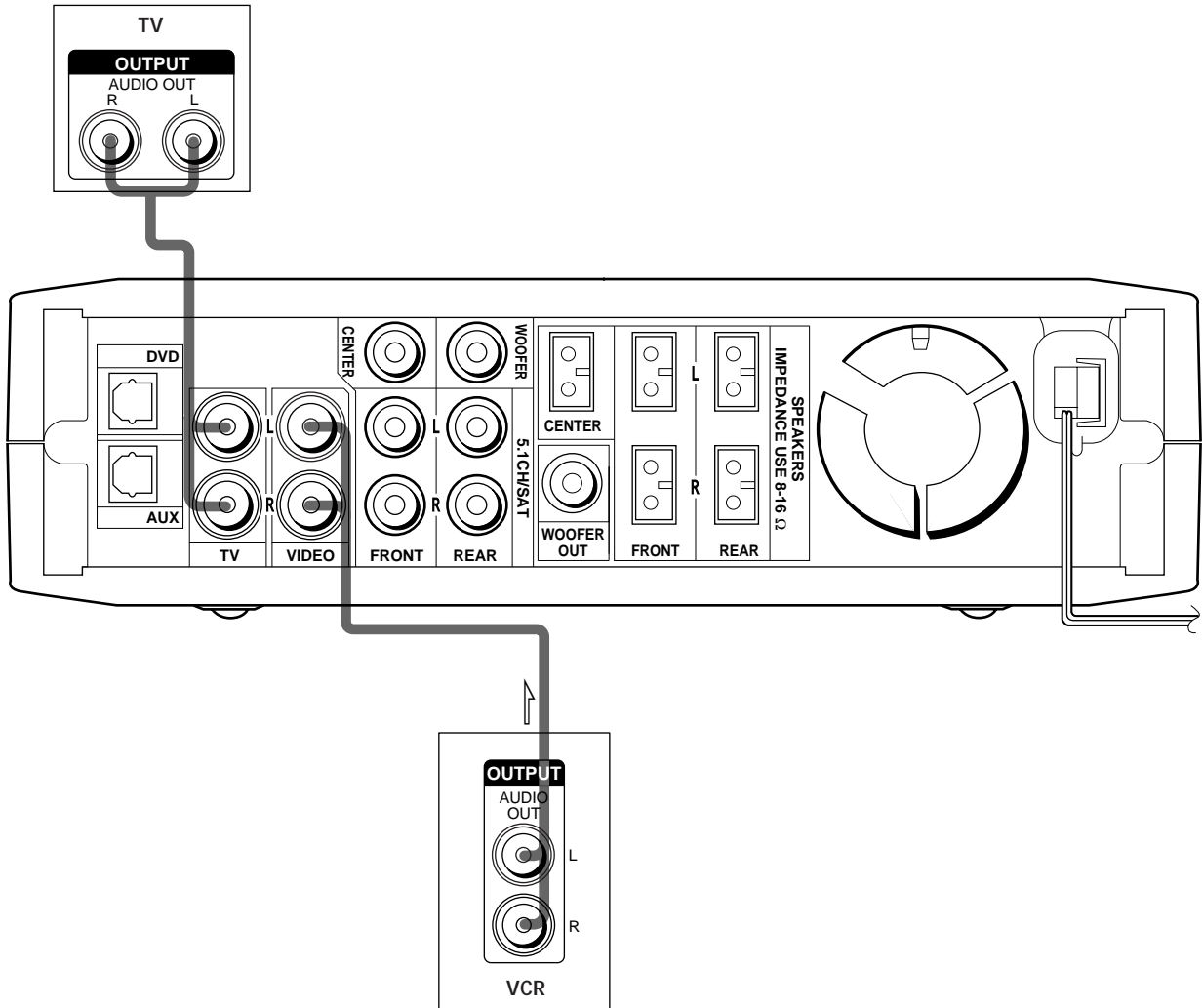
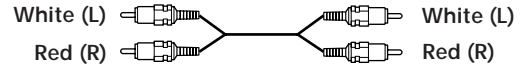

Jacks for connecting video components

Connect a	To the
TV	TV jacks
VCR	VIDEO jacks

Digital Component Hookups

Connect the digital output jacks of your DVD player and audio components (CD player, MD deck, etc.) to the amplifier's digital input jacks to bring the multi channel surround sound of a movie theater into your home. To enjoy full effect of multi channel surround sound, five speakers (two front speakers, two rear speakers, and a center speaker) and a sub woofer are required.

Required cords

Optical digital cords (not supplied)

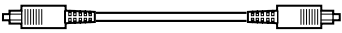
Black  Black

Note

The optical digital input jacks on the amplifier are compatible with sampling frequencies of 32 kHz, 44.1 kHz, 48 kHz and 96 kHz.

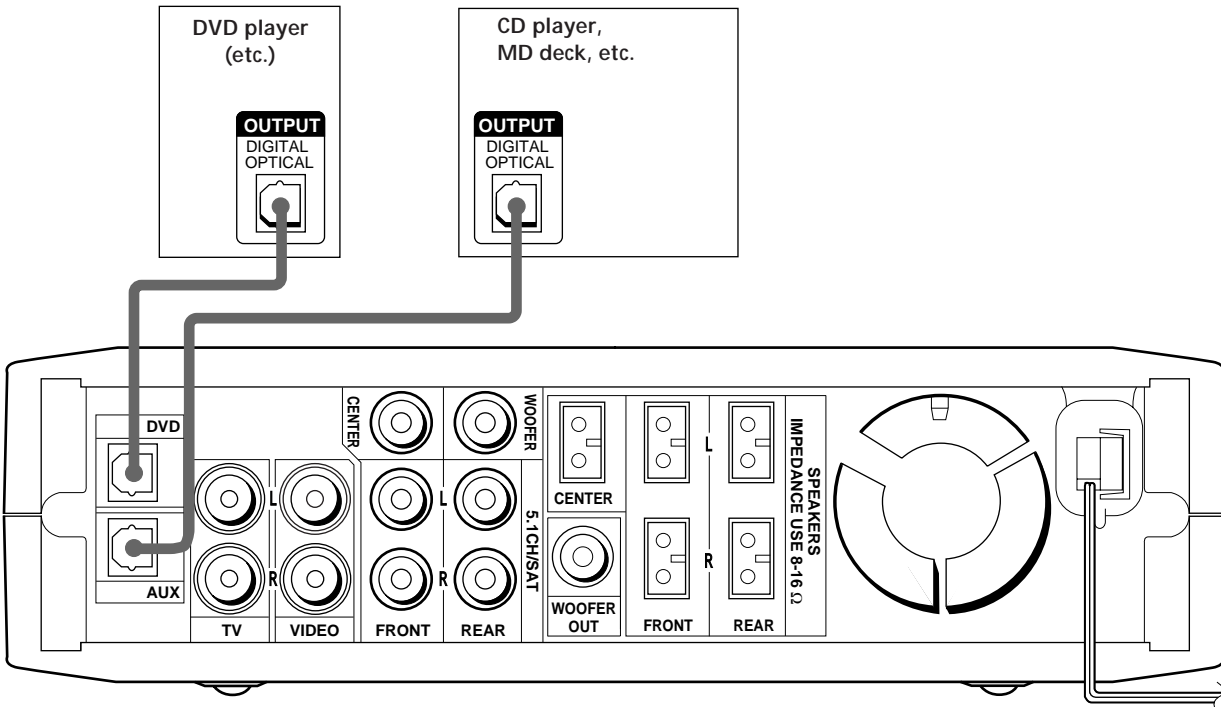

Note

Connect the video jack of your DVD player to the VIDEO IN jack of your TV.

5.1CH/SAT Hookups

Although this amplifier incorporates a multi channel decoder, it is also equipped with 5.1CH/SAT jacks. These connections allow you to enjoy multichannel software encoded in formats other than Dolby Digital (AC-3) and DTS. If your DVD player is equipped with 5.1CH OUTPUT jacks, you can connect them directly to the amplifier to enjoy the sound of the DVD player's multi channel decoder. Alternatively, the 5.1CH/SAT jacks can be used to connect an external multi channel decoder. To fully enjoy multi channel surround sound, you will need five speakers (two front speakers, two rear speakers, and a center speaker) and a subwoofer. Refer to the instruction manual supplied with your DVD player, multi channel decoder, etc., for details on the 5.1 channel input hookups.

Required cords

Audio cords (not supplied)

Two for the 5.1CH/SAT FRONT and REAR jacks



Monaural audio cords (not supplied)

Two for the 5.1CH/SAT CENTER and WOOFER jacks



Note

When using the connections described below, adjust the level of your surround speakers, center speaker and subwoofer from the DVD player or multichannel decoder.

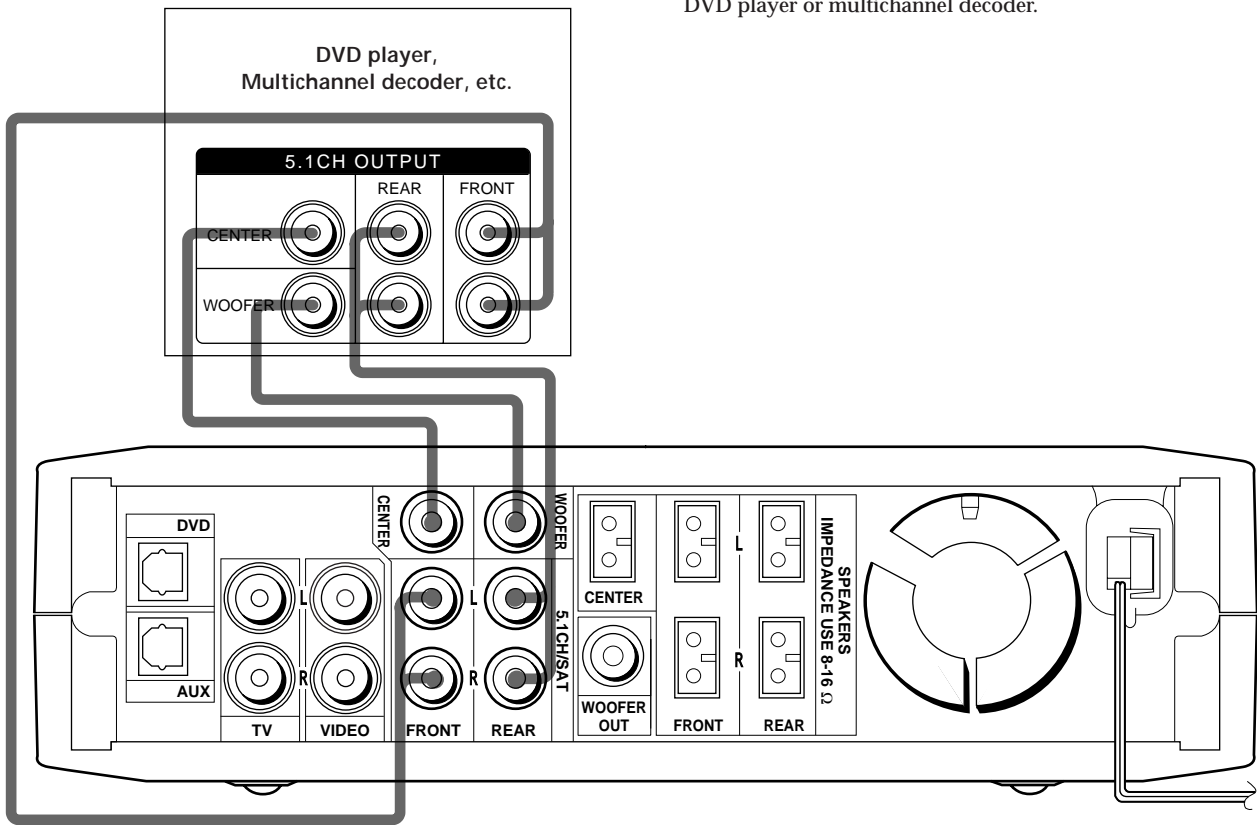

Example of a DVD player hookup using the 5.1 CH/SAT jacks

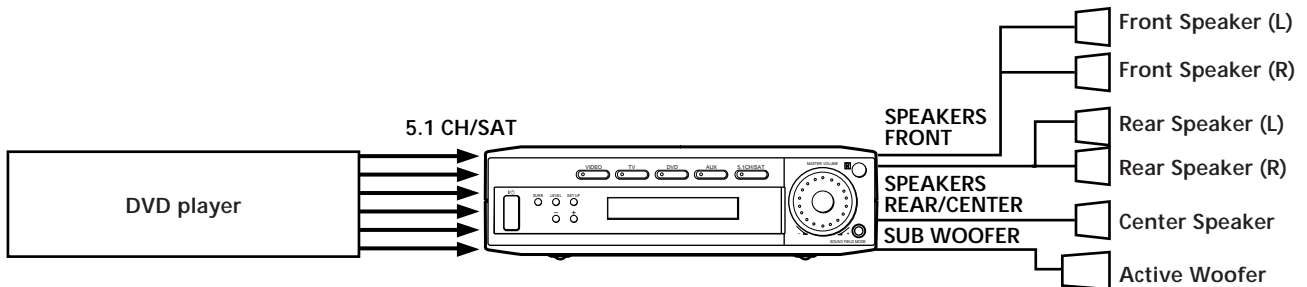

Note

See page 11 for details on speaker system hookup.

Other Hookups

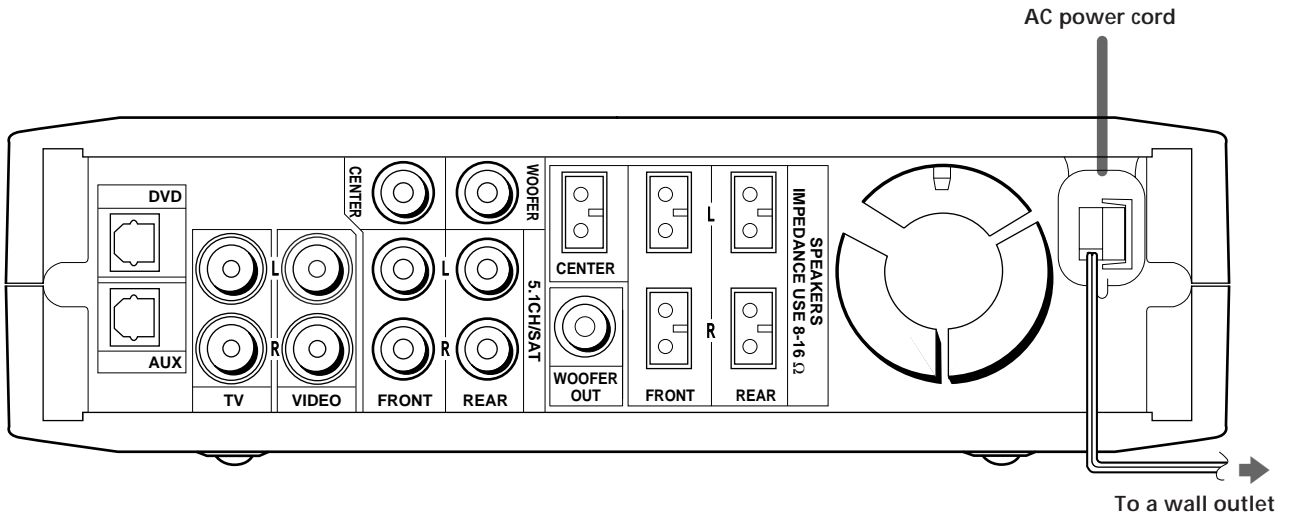

Connecting the AC power cord

Before connecting the AC power cord of this amplifier to a wall outlet:

- Connect the speaker system to the amplifier (see page 11).

Connect the AC power cord(s) of your video components to a wall outlet.

Note

If the AC power cord is disconnected for about two weeks, the amplifier's entire memory will be cleared and the demonstration will start.

Hooking Up and Setting Up the Speaker System

This chapter describes how to hook up your speaker system to the amplifier, how to position each speaker, and how to set up your speakers to enjoy multi channel surround sound.

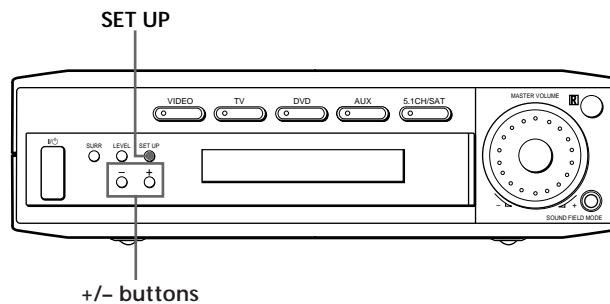

Brief descriptions of buttons and control used to set up the speaker system

SET UP button: Press to enter the setup mode when specifying speaker types and distances.

+/- buttons: Use to select parameters after pressing the SET UP button.

Speaker System Hookup

Required cords

- Speaker connecting cords (supplied)
- One white for SPEAKERS FRONT LEFT
- One red for SPEAKERS FRONT RIGHT
- One green for SPEAKERS CENTER
- One blue for SPEAKERS REAR LEFT
- One yellow for SPEAKERS REAR RIGHT

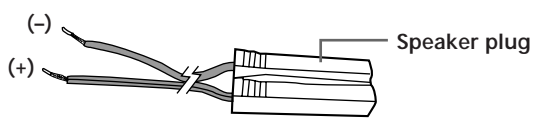

- Monaural connecting cord (supplied)
- One for an active sub woofer



Notes

- Make sure that you insert the speaker connecting cords according to the colour as labelled on the top of the amplifier of the speaker plug ends.

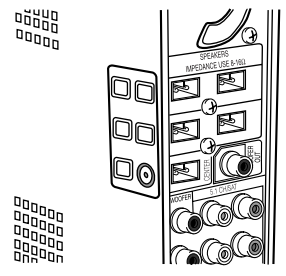

- The polarity of the speaker plugs is fixed on the amplifier.

Speaker System Hookup

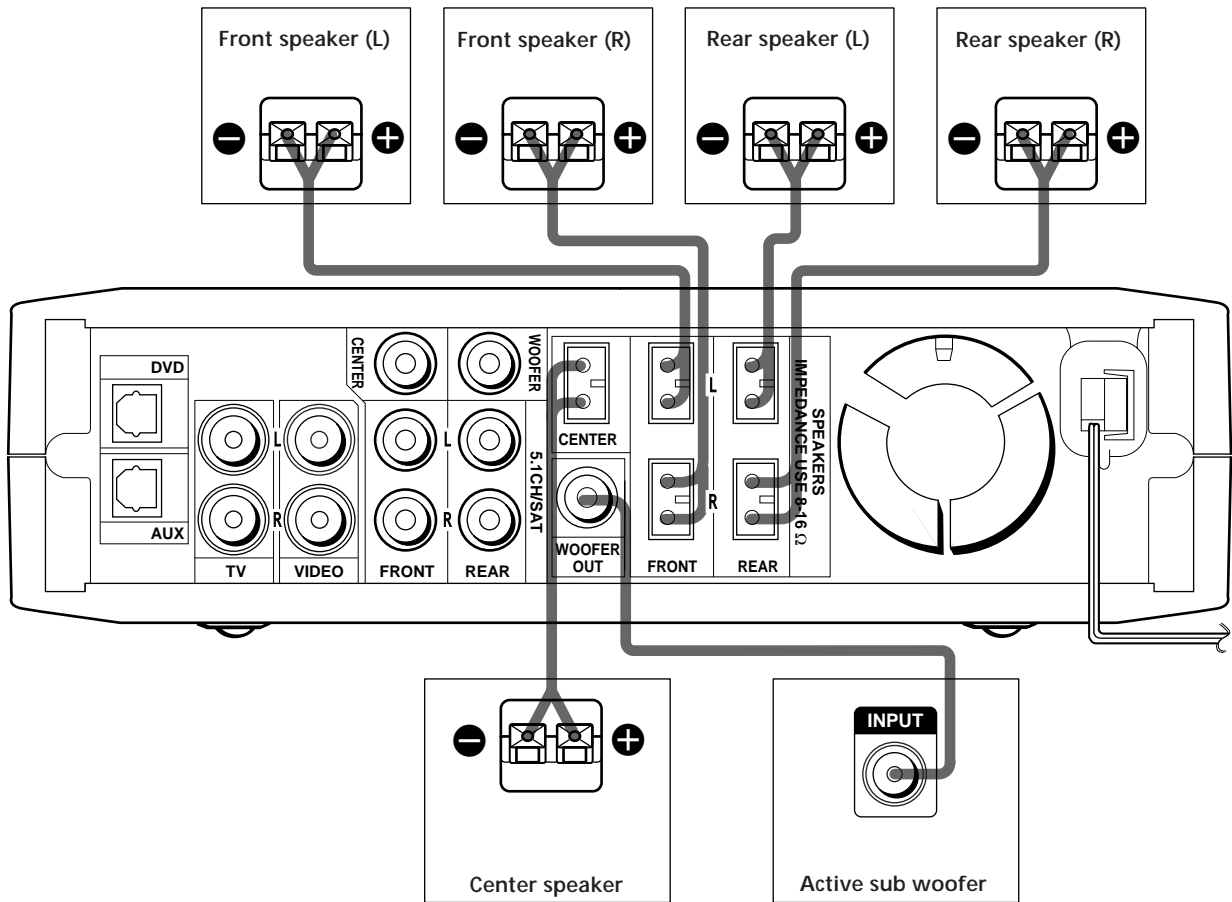

Terminals for connecting the speakers

Connect the	To the
Front speakers (8 ohm)	SPEAKERS FRONT terminals
Rear speakers (8 ohm)	SPEAKERS REAR terminals
Center speaker (8 ohm)	SPEAKERS CENTER terminals
Active sub woofer	WOOFER OUT jack

Notes on speaker system hookup

- Make sure the plus (+) and the minus (-) terminals on the speakers are matched to the corresponding plus (+) and minus (-) terminals on the speaker plugs.
- Make sure all connections are firm. Contact between bare speaker wires at the speaker terminals may cause a short-circuit.

Tip

All striped wires are plus (+) in polarity, and should be connected to the plus (+) speaker terminals.

To avoid short-circuiting the speakers

Short-circuiting of the speakers may damage the amplifier. To prevent this, make sure to take the following precautions when connecting the speakers.

Make sure the stripped ends of each speaker cord does not touch another speaker terminal or the stripped end of another speaker cord.

Examples of poor conditions of the speaker cord

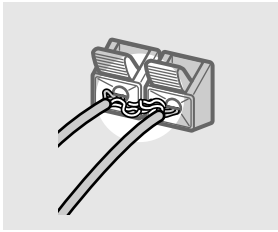

Stripped speaker cord is touching another speaker terminal.

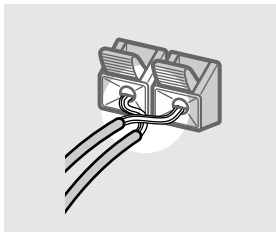

Stripped cords are touching each other due to excessive removal of insulation.

After connecting all the components, speakers, and AC power cord, output a test tone to check that all the speakers are connected correctly. For details on outputting a test tone, see page 18.

If no sound is heard from a speaker while outputting a test tone or a test tone is output from a speaker other than the one whose name is currently displayed on the amplifier, the speaker may be short-circuited. If this happens, check the speaker connection again.

To avoid damaging your speakers

Make sure that you turn down the volume before you turn off the amplifier. When you turn on the amplifier, the volume remains at the level you turn off the amplifier.

Performing Initial Setup Operations

Once you have made speaker connections and have turned on the power for the first time, clear the amplifier's memory. After you have done this, set the speaker sizes, speaker locations and other initial system settings that are necessary.

Clearing the amplifier's memory

Before you use your amplifier for the first time or when you want to clear the amplifier's memory, do the following.

If the Demonstration appears when the power is turned on, this procedure is not necessary.

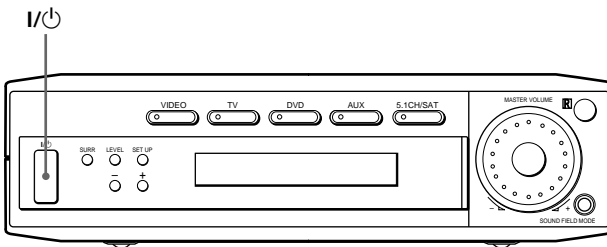

1 Turn off the amplifier.

2 Hold down I/⏻ for four seconds.

The currently selected function, then the demonstration message appears in the display and the items including the following are reset or cleared:

- All sound field parameters are reset to their factory settings.
- All adjustments made with the SET UP button are reset to their factory settings.
- The sound field memorized for each program source is cleared.

Setting up the amplifier

Before you use your amplifier for the first time, use the SET UP button to adjust settings to correspond to your system. You can set the following items. For details on how to adjust each setting, see the page in parentheses.

- Set the speaker size (page 15).
- Set the speaker distance (page 17).

Multi Channel Surround Setup

For the best possible surround sound all speakers should be the same distance from the listening position (A). (However, this unit lets you to place the center speaker up to 1.5 meters (5 feet) closer (B) and the rear speakers up to 4.5 meters (15 feet) closer (C) to the listening position. The front speakers can be placed from 1.0 to 12.0 meters (3 to 40 feet) from the listening position (A).)

You can place the rear speakers either behind you or to the side, depending on the shape of your room (etc.).

When the rear speakers are placed to the side

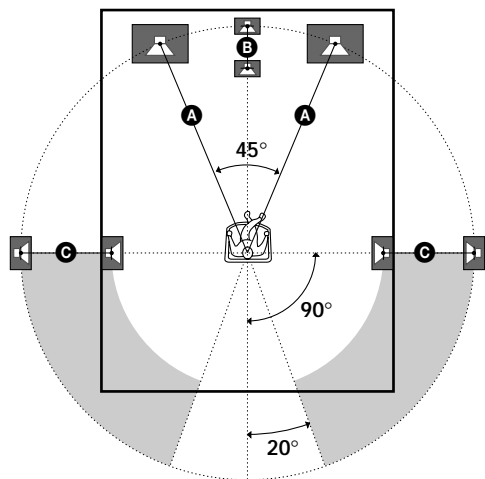

When the rear speakers are placed behind you

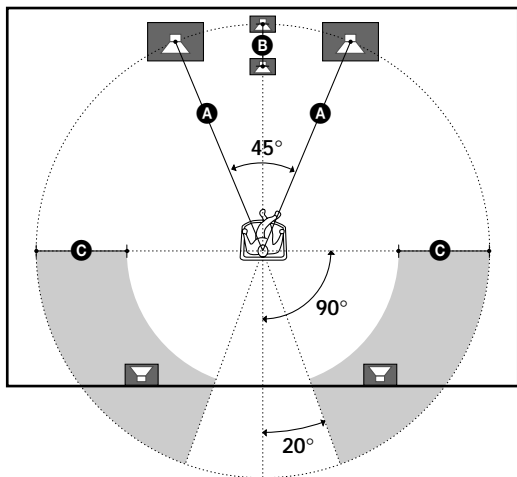

Note

Do not place the center speaker farther away from the listening position than the front speakers.

Specifying the speaker parameters

For HT-K215, the speaker size and sub woofer selection has been preset to MICRO SP. (Micro Satellite Speaker) according to the supplied speaker system. If you change the speaker system, choose NORM. SP. (Normal Speaker) to adjust the speaker size and sub woofer selection. When you choose MICRO SP., the speaker size and the sub woofer selection has been configured as follows:

Speakers	Settings
Front	SMALL
Center	SMALL
Rear	SMALL
Woofer	YES

You cannot change the configuration if you choose MICRO SP.

- 1 Press I/⏻ to turn on the amplifier.
- 2 Press SET UP repeatedly to select the parameter you want to adjust.
- 3 Press +/- to select the setting you want. The setting is stored automatically.
- 4 Repeat steps 2 and 3 until you have set all of the parameters that follow.

The following speaker size setup is applicable for NORM. SP.

■ **Front speaker size** (L) (R)

Initial setting : LARGE

- If you connect large speakers that will effectively reproduce bass frequencies, select "LARGE". Normally, select "LARGE".
- If the sound is distorted, or you feel a lack of surround effects when using multi channel surround sound, select "SMALL" to activate the bass redirection circuitry and output the front channel bass frequencies from the sub woofer.
- When the front speaker is set to "SMALL", the center and rear speakers are also automatically set to "SMALL" (unless previously set to "NO").

Multi Channel Surround Setup

■ Center speaker size (C) ()

Initial setting : LARGE

- If you connect a large speaker that will effectively reproduce bass frequencies, select "LARGE". Normally, select "LARGE". However, if the front speakers are set to "SMALL", you cannot set the center speaker to "LARGE".
- If the sound is distorted, or you feel a lack of surround effects when using multi channel surround sound, select "SMALL" to activate the bass redirection circuitry and output the center channel bass frequencies from the front speakers (if set to "LARGE") or sub woofer. *1
- If you do not connect the center speaker, select "NO". The sound of the center channel will be output from the front speakers.*2

■ Rear speaker size (LS) (RS) ()

Initial setting : LARGE

- If you connect large speakers that will effectively reproduce bass frequencies, select "LARGE". Normally, select "LARGE". However, if the front speakers are set to "SMALL", you cannot set the rear speakers to "LARGE".
- If the sound is distorted, or you feel a lack of surround effects when using multi channel surround sound, select "SMALL" to activate the bass redirection circuitry and output the rear channel bass frequencies from the sub woofer or other "LARGE" speakers.
- If you do not connect rear speakers, select "NO".*3

*1~*3 correspond to the following Dolby Pro Logic modes

*1 NORMAL

*2 PHANTOM

*3 3 STEREO

💡 About speaker sizes (LARGE and SMALL)

Internally, the LARGE and SMALL settings for each speaker determine whether or not the internal sound processor will cut the bass signal from that channel. When the bass is cut from a channel the bass redirection circuitry sends the corresponding bass frequencies to the sub woofer or other "LARGE" speaker. However, since bass sounds have a certain amount of directionality it best not to cut them, if possible. Therefore, even when using small speakers, you can set them to "LARGE" if you want to output the bass frequencies from that speaker. On the other hand, if you are using a large speaker, but prefer not to have bass frequencies output from that speaker, set it to "SMALL".

If the overall sound level is lower than you prefer, set all speakers to "LARGE".

■ Rear speaker position (REAR PL.)*

Initial setting : BEHIND

This parameter lets you specify the location of your rear speakers for proper implementation of the Digital Cinema Sound surround modes in the "VIRTUAL" sound fields. Refer to the illustration below.

- Select "SIDE" if the location of your rear speakers corresponds to section A.
- Select "BEHIND" if the location of your rear speakers corresponds to section B.

This setting only effects the surround modes in the "VIRTUAL" sound fields.

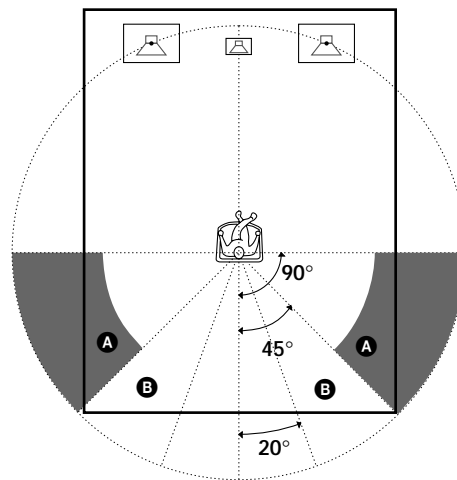

* These parameters are not available when "Rear speaker size (REAR)" is set to "NO".

■ Rear speaker height (REAR HGT.)*

Initial setting : LOW

This parameter lets you specify the height of your rear speakers for proper implementation of the Digital Cinema Sound surround modes in the “VIRTUAL” sound fields. Refer to the illustration below.

- Select “LOW” if the location of your rear speakers corresponds to section **A**.
- Select “HIGH” if the location of your rear speakers corresponds to section **B**.

This setting only affects the surround modes in the “VIRTUAL” sound fields.

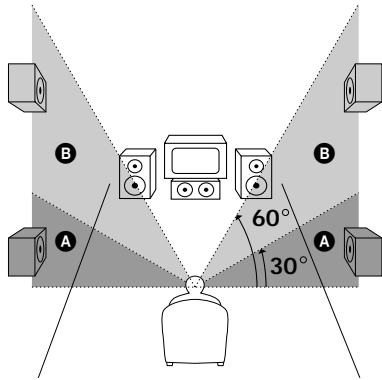

* These parameters are not available when “Rear speaker size (REAR)” is set to “NO”.

💡 About the rear speaker position (SIDE, and BEHIND)

This setting is designed specifically for implementation of the Digital Cinema Sound modes in the “VIRTUAL” sound fields. With the Digital Cinema Sound modes, speaker position is not as critical as other modes. All of the modes in the “VIRTUAL” sound fields were designed under the premise that the rear speaker would be located behind the listening position, but presentation remains fairly consistent even with the rear speakers positioned at a rather wide angle. However, if the speakers are pointing toward the listener from the immediate left and right of the listening position, the “VIRTUAL” sound fields will not be effective unless the rear speaker position parameter is set to “SIDE”.

Nevertheless, each listening environment has many variables, such as wall reflections, and you may obtain better results using “BEHIND” if your speakers are located high above the listening position, even if they are to the immediate left and right. Therefore, although it may result in a setting contrary to the “Rear speaker position” explanation, we recommend that you play back multi channel surround encoded software and listen to the effect each setting has on your listening environment. Choose the setting that provides a good sense of spaciousness and that best succeeds in forming a cohesive space between the surround sound from the rear speakers and the sound from the front speakers. If you are not sure which sounds best, select “BEHIND” and then use the speaker distance parameter and speaker level adjustments to obtain proper balance.

■ Sub woofer selection (SUB WOOFER)

Initial setting : YES

- If you connect a sub woofer, select “YES”.
- If you do not connect a sub woofer, select “NO”. This activates the bass redirection circuitry and outputs the LFE signals from other speakers.
- In order to take full advantage of the Dolby Digital (AC-3) bass redirection circuitry, we recommend that you set your sub woofer’s cut off frequency as high as possible.

■ Front speaker distance (FRONT)

Initial setting : 5.0 meter

Set the distance from your listening position to the front (left or right) speaker (**A** on page 15).

- Front speaker distance can be set in 0.1 meter (1 foot) steps from 1.0 to 12.0 meters (3 to 40 feet).
- If both speakers are not placed an equal distance from your listening position, set the distance to the closest speaker.

■ Center speaker distance (CENTER)

Initial setting : 5.0 meter

Set the distance from your listening position to the center speaker.

- Center speaker distance can be set in 0.1 meter (1 foot) steps from a distance equal to the front speaker distance (**A** on page 15) to a distance 1.5 meters (5 feet) closer to your listening position (**B** on page 15).
- Do not place the center speaker farther away from your listening position than the front speakers.

■ Rear speaker distance (REAR)

Initial setting : 3.5 meter

Set the distance from your listening position to the rear (left or right) speaker.

- Rear speaker distance can be set in 0.1 meter (1 foot) steps from a distance equal to the front speaker distance (**A** on page 15) to a distance 4.5 meters (15 feet) closer to your listening position (**C** on page 15).
- Do not place the rear speakers farther away from your listening position than the front speakers.
- If both speakers are not placed an equal distance from your listening position, set the distance to the closest speaker.

Multi Channel Surround Setup

About speaker distances

This amplifier allows you to input the speaker position in terms of distance. However, it is not possible to set the center speaker farther away than the front speakers. Also, the center speaker can not be set more than 1.5 meters (5 feet) closer than the front speakers.

Likewise, the rear speakers cannot be set farther away from the listening position than the front speakers. And they can be no more than 4.5 meters (15 feet) closer.

This is because incorrect speaker placement is not conducive to enjoy the surround sound.

Please note that, setting the speaker distance closer than the actual location of the speakers will cause a delay in the output of the sound from that speaker. In other words, the speaker will sound like it is farther away.

For example, setting the center speaker distance 1~2 m (3~6 feet) closer than the actual speaker position will create a fairly realistic sensation of being “inside” the screen. If you cannot obtain a satisfactory surround effect because the rear speakers are too close, setting the rear speaker distance closer (shorter) than the actual distance will create a larger soundstage. (1 foot corresponds to a 1 ms difference.)

Adjusting these parameters while listening to the sound often results in much better surround sound. Give it a try!

Note

If you are using a Sony DVD player together with this home theater system, set your DVD player to the following configuration:

Speakers	Settings
Front	SMALL
Center	SMALL
Rear	SMALL
Subwoofer	YES

If you are using a non Sony DVD player, refer to the operating instructions supplied with the DVD player for speaker setup.

Adjusting the speaker volume

Use the remote while seated in your listening position to adjust the volume of each speaker.

Note

This amplifier incorporates a new test tone with a frequency centered at 800 Hz for easier speaker volume adjustment.

- 1 Press **I/⏻** to turn on the amplifier.
- 2 Press **TEST TONE** on the supplied remote. You will hear the test tone from each speaker in sequence.
- 3 Adjust the volume level so that the volume of the test tone from each speaker sounds the same when you are in your main listening position.
 - To adjust the balance of the front right and front left speakers, press **MENU </>** to select the front balance parameter. Use **+/-** on the remote to adjust the level. (or see page 27).
 - To adjust the balance of the rear right and rear left speakers, press **MENU </>** to select the rear balance parameter. Use **+/-** on the remote to adjust the level. (or see page 27).
 - To adjust the volume level of the center speaker, press **MENU </>** to select the center parameter. Use **+/-** on the remote to adjust the level.
 - To adjust the volume level of the rear speaker, press **MENU </>** to select the rear parameter. Use **+/-** on the remote to adjust the level.
- 4 Press **TEST TONE** on the remote again to turn off the test tone.

Note

The test tone cannot be output when the amplifier is set to 5.1CH/SAT.

 You can adjust the volume level of all speakers at the same time

Rotate **MASTER VOLUME** on the amplifier or press **MASTER VOL +/-** on the remote.

Notes

- The front balance, rear balance, center level, and rear level are shown in the display during adjustment.
- Although these adjustments can also be made via the front panel using the LEVEL menu (when the test tone is output, the amplifier switches to the LEVEL menu automatically), we recommend you follow the procedure described above and adjust the speaker levels from your listening position using the remote control.

💡 When setting the volume levels for each speaker

Let's assume that you have matched the sound levels of all the speakers using the test tone. Although this lays the foundation for high quality surround sound, it may be necessary to make further adjustments while listening to playback of actual software. This is because most software contains center and rear channels recorded at slightly lower levels than the two front channels.

When you actually play back software recorded in multi channel surround, you will notice that increasing the center and rear speaker levels produces a better blend between the front and center speakers and greater cohesion between the front and rear speakers. Increasing the level of the center speaker about 1 dB, and the rear speakers about 1~2 dB is likely to produce better results.

In other words, in order to create a more cohesive soundstage with balanced dialog, we recommend that you make some adjustments while playing your software. Changes of only 1 dB can make a huge difference in the character of the soundstage.

Listening to the sound

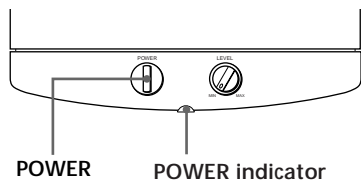

First, turn down the volume on the amplifier. The volume should be set to minimum before you begin playing the programme source.

- 1 Turn on the amplifier and select the programme source.
- 2 Press **POWER** on the subwoofer.
The **POWER** indicator on the subwoofer lights up in green.
- 3 Play the programme source.

Adjusting the sound

Slight adjustments to the system can enhance your sound enjoyment.

Adjusting the subwoofer

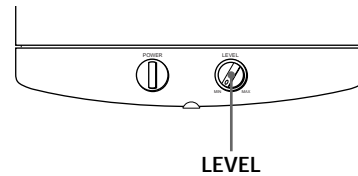

- 1 Rotate **LEVEL** to adjust the volume.
Set the volume level to best suit your preference according to the programme source.

Note

To enjoy high-quality sound, do not turn the subwoofer volume too high.

Before You Use Your Amplifier

Checking the connections

After connecting all of your components to the amplifier, do the following to verify that the connections were made correctly.

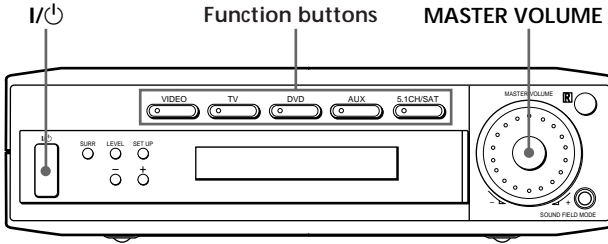

- 1 Press I/Power to turn on the amplifier.
- 2 Press a function button to select a component (program source) that you connected (e.g., VIDEO, TV).
- 3 Turn on the component and start playing it.
- 4 Rotate MASTER VOLUME to turn up the volume.

If you do not obtain normal sound output after performing this procedure, look for the reason in the checklist on this page and take the appropriate measures to correct the problem.

There is no sound no matter which component is selected.

- ➔ Check that both the amplifier and all components are turned on.
- ➔ Check that the volume level on the display is not set to VOL MIN by turning the MASTER VOLUME.
- ➔ Check that all speaker cords are connected correctly.
- ➔ Press MUTING on the remote to turn off the MUTING function.

There's no sound from a specific component.

- ➔ Check that the component is connected correctly to audio input jacks for that component.
- ➔ Check that the cord(s) used for the connection is (are) fully inserted into the jacks on both the amplifier and the component.

If you encounter a problem that is not included above, see "Troubleshooting" on page 34.

Location of Parts and Basic Operations

This chapter provides information about the locations and functions of the buttons and controls on the front panel. It also explains basic operations.

Front Panel Parts Descriptions

1 I/⏻ switch

Press to turn the amplifier on and off.

2 Function buttons

Press one of the buttons to select the component you want to use.

To select	Press
VCR	VIDEO
TV	TV
DVD player	DVD
An audio component	AUX
DVD through AC-3 decoder	5.1 CH/SAT

After selecting the component, turn on the component you selected and play the program source.

- After selecting VCR or DVD player, turn on the TV and set the TV's video input to match the component you selected.

Front Panel Parts Descriptions

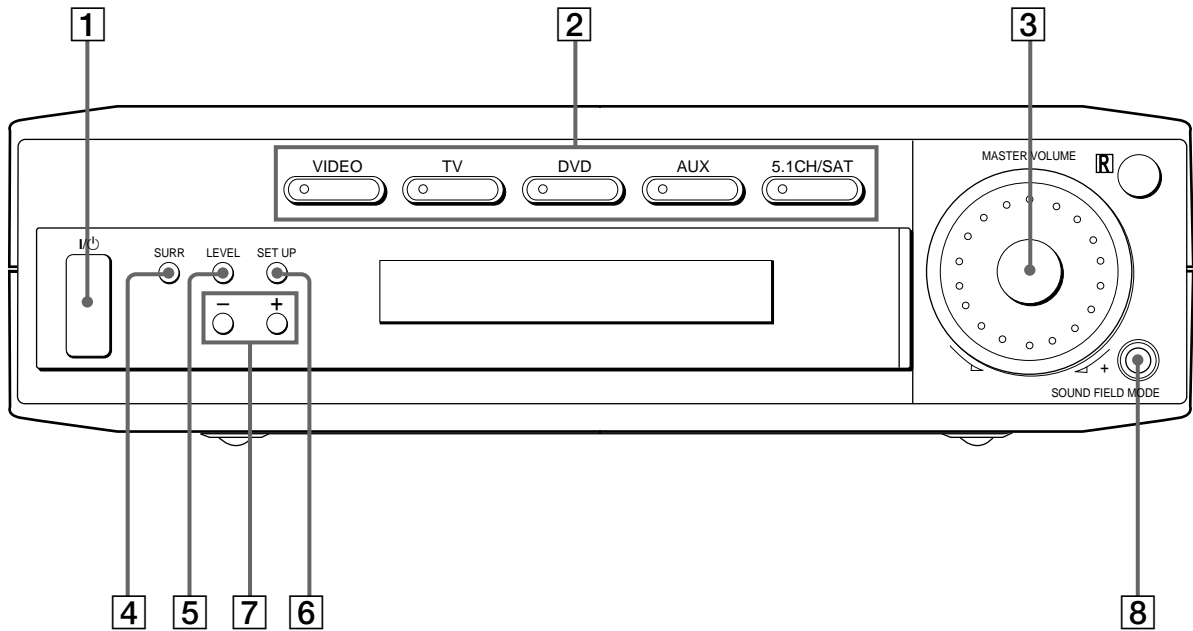

3 MASTER VOLUME control

After turning on the component you selected, rotate to adjust the volume.

4 SURR button

Press repeatedly to activate the surround parameters (page 29) and to adjust the various surround parameters (effect level, wall type, etc.). You can then make various settings using the +/- buttons (7).

5 LEVEL button

Press repeatedly to activate the speaker level parameters (page 30) and to adjust the various speaker level parameters (front balance, rear balance, etc.). You can then make various settings using the +/- buttons (7).

6 SET UP button

Press repeatedly to activate the setup mode and to select any of the following indications. You can then make various settings using the +/- buttons (7).

When you select	You can
Speaker type	Specify the type of speakers. (page 15)
Speaker setup	Specify the front, center, rear speaker sizes, the rear speaker position, and whether or not you are using a sub woofer. (page 15)
Speaker Distance	Specify the front, center, and rear speaker distances. (page 17)

7 +/- buttons

Press to adjust the selected speaker level and surround parameters (etc.).

8 SOUND FIELD MODE

Press repeatedly to activate the sound field selection mode and to select the sound field you want (page 24).

Enjoying Surround Sound

This chapter describes how to set up the amplifier to enjoy surround sound. You can enjoy multi channel surround when playing back software encoded with Dolby Digital or DTS.

You can take advantage of surround sound simply by selecting one of the amplifier's pre-programmed sound modes. They bring the exciting and powerful sound of movie theaters and concert halls into your home. You can also customize the sound modes to obtain the sound you desire by changing the various surround parameters. The amplifier contains a variety of different sound modes. The cinema sound modes are designed for use when playing back movie software (DVD, LD, etc.) encoded with multi channel surround sound or Dolby Pro Logic. In addition to decoding the surround sound, some of these modes also provide sound effects commonly found in movie theaters.

The virtual sound modes contain compelling applications of the Sony Digital Cinema Sound digital signal processing technology. They shift the sound away from the actual speaker locations to simulate the presence of several "virtual" speakers.

The music (etc.) sound modes are designed for use with standard audio sources and TV broadcasts. They add reverberation to the source signal to make you feel as if you were in a concert hall or stadium (etc.). Use these sound modes with two-channel sources like CD and stereo broadcasts of sports programs or musical concerts. For more information about the sound modes, see pages 25 - 26.

A.F.D.

The "Auto Format Decoding" sound mode presents the sound exactly as it was encoded, without adding any reverberation (etc.).

To fully enjoy surround sound, you must register the number and location of your speakers. See "Multi-Channel Surround setup" starting on page 15 to set the speaker parameters before enjoying surround sound.

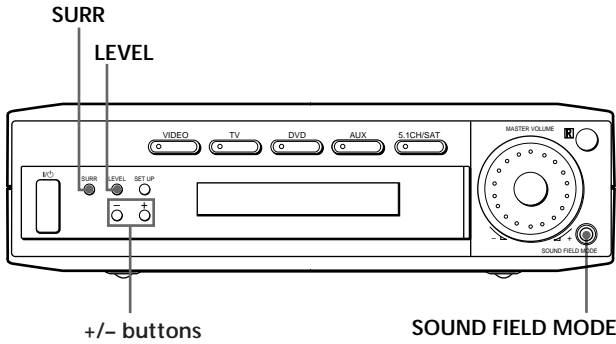

Brief descriptions of buttons used to enjoy surround sound

- LEVEL button:** Press to customize the level parameters.
- SURR button:** Press to customize the surround parameters in the current sound field.
- +/- buttons:** Use to adjust parameters and select sound fields (etc.).
- SOUND FIELD MODE button:** Press to activate the sound field selection mode.

Selecting a Sound Field



You can enjoy surround sound simply by selecting one of the pre-programmed sound fields according to the program you want to listen to.

- 1 Press SOUND FIELD MODE.**
The current sound field is indicated in the display.
- 2 Press SOUND FIELD MODE repeatedly to select the sound field you want.**
See the table starting on page 25 for information on each sound field.

To turn the sound field off

Press SOUND FIELD MODE repeatedly to select A.F.D or 2 CH.

 The amplifier memorizes the last sound field selected for each program source (Sound Field Link). Whenever you select a program source, the sound field that was last applied is automatically applied again. For example, if you listen to CD with HALL as the sound field, change to a different program source, then return to CD, HALL will be applied again.

 You can identify Dolby Surround-encoded software by looking at the packaging. Dolby Digital discs are labeled with the  logo, and Dolby Surround encoded programs are labeled with the  logo.

Sound field information

Sound field	Effect	Notes
NORM.SURR. (NORMAL SURROUND)	Software with multi channel surround audio signals is played according to the way it was recorded. Software with two channel audio signals, is decoded with Dolby Pro Logic to create surround effects.	
CINEMA A (CINEMA STUDIO A)	Reproduces the sound characteristics of the Sony Pictures Entertainment "Cary Grant Theater" cinema production studio.	This is a standard mode, great for watching most type of movie.
CINEMA B (CINEMA STUDIO B)	Reproduces the sound characteristics of the Sony Pictures Entertainment "Kim Novak Theater" cinema production studio.	This mode is ideal for watching science-fiction or action movies with lots of sound effects.
CINEMA C (CINEMA STUDIO C)	Reproduces the sound characteristics of the Sony Pictures Entertainment scoring stage.	This mode is ideal for watching musicals or classic films where music is featured in the soundtrack.
V.M.DIMENS.* (VIRTUAL MULTI DIMENSION)	Uses 3D sound imaging to create an array of virtual rear speakers positioned higher than the listener from a single pair of actual rear speakers. This mode creates four sets of virtual speakers surrounding the listener at approximately a 30° angle of elevation.	<div style="display: flex; align-items: center;"> <div style="margin-right: 20px;">SIDE**</div> </div> <div style="display: flex; align-items: center;"> <div style="margin-right: 20px;">BEHIND**</div> </div> <div style="text-align: right; margin-top: 10px;">** See page 16</div>
V.SEMI M.D.* (VIRTUAL SEMI-MULTI DIMENSION)	Uses 3D sound imaging to create virtual rear speakers from the sound of the front speakers without using actual rear speakers. This mode creates five sets of virtual speakers surrounding the listener at a 30° angle of elevation.	

* "VIRTUAL" sound field: Sound field with virtual speakers.

Selecting a Sound Field

Sound field information

Sound field	Effect	Notes
HALL	Reproduces the acoustics of a rectangular concert hall.	Ideal for soft acoustic sounds.
JAZZ (JAZZ CLUB)	Reproduces the acoustics of a jazz club.	
LIVE (LIVE HOUSE)	Reproduces the acoustics of a 300-seat live house.	Great for rock or pop music.
GAME	Obtains maximum audio impact from video game software.	Be sure to set the game machine to stereo mode when using game software with stereo sound capabilities.

Notes

- The effects provided by the virtual speakers may cause increased noise in the playback signal.
- When listening to sound fields that employ the virtual speakers, you will not be able to hear any sound coming directly from the rear speakers.

Use the buttons on the remote to operate the following modes

AUTO FORMAT DECODING (Press the A.F.D. button)	Automatically detects the type of audio signal being input (Dolby Digital, Dolby Pro Logic, or standard two channel stereo) and performs the proper decoding if necessary. This mode presents the sound as it was recorded/encoded, without adding any effects.	The "Auto Format Decoding" sound mode presents the sound exactly as it was encoded, without adding any reverberation (etc.).
2 CHANNEL (Press the 2CH/OFF button)	Outputs the sound from the front left and right speakers only. Standard two channel (stereo) sources completely bypass the sound field processing. Multi channel surround formats are downmixed to two channels.	This allows you to play any source using only the front left and right speakers.

Note

To listen to two channel (stereo) sources using the front left and right speakers and a sub woofer, use the AUTO FORMAT DECODING mode.

Understanding the Multi-Channel Surround Displays

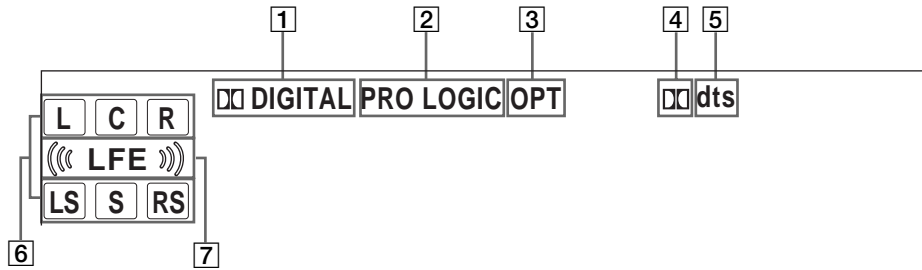

1 DIGITAL

This indicator lights up when a sound field other than 2 CHANNEL is selected and the unit is decoding signals recorded in the Dolby Digital (AC-3) format.*
 * However, this indicator does not light when the recording format is 2/0 or 2/0 Pro Logic.

7 ((LFE))

((LFE)) will light up when the disc being played contains the LFE (Low Frequency Effect) channel and when the sound of the LFE channel signal is actually being reproduced.

2 PRO LOGIC

Lights up when the amplifier applies Pro Logic processing to two channel signals in order to output the center and surround channel signals.**
 ** However, this indicator does not light if the center and rear speakers are set to "NO", and the A.F.D. or NORMAL SURROUND sound fields are selected.

3 OPT

Lights up when the source signal is a digital signal being input through the OPT terminal.

4 DIGITAL

Lights up when Dolby Digital (AC-3) signals are input through the OPT terminal.

5 dts

Lights up when DTS signals are input through the OPT terminal.

6 Playback channel indicators

The letters light up to indicate the channels being played back.

- L: Front Left
- C: Center (monaural)
- RS: Right Surround
- R: Front Right
- LS: Left Surround
- S: Surround (monaural or the rear components obtained by Pro Logic processing)

The boxes around the letters light up to indicate the speakers used to playback the channels.
 See the next page for details regarding the playback channel indicators.

Understanding the Multi-Channel Surround Displays

Source sound displays

The letters (L, C, R, etc.) indicate the source sound. The box around the letters varies to show how the amplifier downmixes the source sound (based on the speakers settings). When using music sound modes such as HALL or JAZZ CLUB, the amplifier adds reverberation based on the source sound.

The following table shows how the indicators light up when using AUTO FORMAT DECODING mode.

Although the table below shows almost all of the configurations available from multi channel surround signals, the ones marked “☆” are the most common.

Recording Format (Front/Rear)	Input Channel Display	Source sound and Output Channel Display			
		All speakers present	Rear speakers absent	Center speaker absent	Rear/center speakers absent
1/0	DOLBY DIGITAL [1/0]	<input checked="" type="checkbox"/> DIGITAL <input checked="" type="checkbox"/> C	<input checked="" type="checkbox"/> DIGITAL <input checked="" type="checkbox"/> C	<input checked="" type="checkbox"/> DIGITAL <input type="checkbox"/> c <input type="checkbox"/>	<input checked="" type="checkbox"/> DIGITAL <input type="checkbox"/> c <input type="checkbox"/>
	DTS [1/0]	_____ <input checked="" type="checkbox"/> C dts	_____ <input checked="" type="checkbox"/> C dts	_____ <input type="checkbox"/> c <input type="checkbox"/> dts	_____ <input type="checkbox"/> c <input type="checkbox"/> dts
2/0*	DOLBY DIGITAL [2/0]	_____ <input type="checkbox"/> L <input type="checkbox"/> R	_____ <input type="checkbox"/> L <input type="checkbox"/> R	_____ <input type="checkbox"/> L <input type="checkbox"/> R	_____ <input type="checkbox"/> L <input type="checkbox"/> R
	DTS [2/0]	_____ <input type="checkbox"/> L <input type="checkbox"/> R dts	_____ <input type="checkbox"/> L <input type="checkbox"/> R dts	_____ <input type="checkbox"/> L <input type="checkbox"/> R dts	_____ <input type="checkbox"/> L <input type="checkbox"/> R dts
3/0	DOLBY DIGITAL [3/0]	<input checked="" type="checkbox"/> DIGITAL <input checked="" type="checkbox"/> L <input checked="" type="checkbox"/> C <input checked="" type="checkbox"/> R	<input checked="" type="checkbox"/> DIGITAL <input checked="" type="checkbox"/> L <input checked="" type="checkbox"/> C <input checked="" type="checkbox"/> R	<input checked="" type="checkbox"/> DIGITAL <input type="checkbox"/> L <input type="checkbox"/> c <input type="checkbox"/> R	<input checked="" type="checkbox"/> DIGITAL <input type="checkbox"/> L <input type="checkbox"/> c <input type="checkbox"/> R
	DTS [3/0]	_____ <input type="checkbox"/> L <input type="checkbox"/> C <input type="checkbox"/> R dts	_____ <input type="checkbox"/> L <input type="checkbox"/> C <input type="checkbox"/> R dts	_____ <input type="checkbox"/> L <input type="checkbox"/> c <input type="checkbox"/> R dts	_____ <input type="checkbox"/> L <input type="checkbox"/> c <input type="checkbox"/> R dts
2/1	DOLBY DIGITAL [2/1]	<input checked="" type="checkbox"/> DIGITAL <input type="checkbox"/> L <input type="checkbox"/> R _____ <input type="checkbox"/> S	<input checked="" type="checkbox"/> DIGITAL <input type="checkbox"/> L <input type="checkbox"/> R _____ s	<input checked="" type="checkbox"/> DIGITAL <input type="checkbox"/> L <input type="checkbox"/> R _____ <input type="checkbox"/> S	<input checked="" type="checkbox"/> DIGITAL <input type="checkbox"/> L <input type="checkbox"/> R _____ s
	DTS [2/1]	_____ <input type="checkbox"/> L <input type="checkbox"/> R dts <input type="checkbox"/> S	_____ <input type="checkbox"/> L <input type="checkbox"/> R dts s	_____ <input type="checkbox"/> L <input type="checkbox"/> R dts <input type="checkbox"/> S	_____ <input type="checkbox"/> L <input type="checkbox"/> R dts s
3/1	DOLBY DIGITAL [3/1]	<input checked="" type="checkbox"/> DIGITAL <input type="checkbox"/> L <input type="checkbox"/> C <input type="checkbox"/> R _____ <input type="checkbox"/> S	<input checked="" type="checkbox"/> DIGITAL <input type="checkbox"/> L <input type="checkbox"/> C <input type="checkbox"/> R _____ s	<input checked="" type="checkbox"/> DIGITAL <input type="checkbox"/> L <input type="checkbox"/> c <input type="checkbox"/> R _____ <input type="checkbox"/> S	<input checked="" type="checkbox"/> DIGITAL <input type="checkbox"/> L <input type="checkbox"/> c <input type="checkbox"/> R _____ s
	DTS [3/1]	_____ <input type="checkbox"/> L <input type="checkbox"/> C <input type="checkbox"/> R dts <input type="checkbox"/> S	_____ <input type="checkbox"/> L <input type="checkbox"/> C <input type="checkbox"/> R dts s	_____ <input type="checkbox"/> L <input type="checkbox"/> c <input type="checkbox"/> R dts <input type="checkbox"/> S	_____ <input type="checkbox"/> L <input type="checkbox"/> c <input type="checkbox"/> R dts s
2/2	DOLBY DIGITAL [2/2]	<input checked="" type="checkbox"/> DIGITAL <input type="checkbox"/> L <input type="checkbox"/> R _____ <input type="checkbox"/> LS <input type="checkbox"/> RS	<input checked="" type="checkbox"/> DIGITAL <input type="checkbox"/> L <input type="checkbox"/> R _____ LS RS	<input checked="" type="checkbox"/> DIGITAL <input type="checkbox"/> L <input type="checkbox"/> R _____ <input type="checkbox"/> LS <input type="checkbox"/> RS	<input checked="" type="checkbox"/> DIGITAL <input type="checkbox"/> L <input type="checkbox"/> R _____ LS RS
	DTS [2/2]	_____ <input type="checkbox"/> L <input type="checkbox"/> R dts <input type="checkbox"/> LS <input type="checkbox"/> RS	_____ <input type="checkbox"/> L <input type="checkbox"/> R dts LS RS	_____ <input type="checkbox"/> L <input type="checkbox"/> R dts <input type="checkbox"/> LS <input type="checkbox"/> RS	_____ <input type="checkbox"/> L <input type="checkbox"/> R dts LS RS
3/2	☆ DOLBY DIGITAL [3/2]	<input checked="" type="checkbox"/> DIGITAL <input type="checkbox"/> L <input type="checkbox"/> C <input type="checkbox"/> R _____ <input type="checkbox"/> LS <input type="checkbox"/> RS	<input checked="" type="checkbox"/> DIGITAL <input type="checkbox"/> L <input type="checkbox"/> C <input type="checkbox"/> R _____ LS RS	<input checked="" type="checkbox"/> DIGITAL <input type="checkbox"/> L <input type="checkbox"/> c <input type="checkbox"/> R _____ <input type="checkbox"/> LS <input type="checkbox"/> RS	<input checked="" type="checkbox"/> DIGITAL <input type="checkbox"/> L <input type="checkbox"/> c <input type="checkbox"/> R _____ LS RS
	☆ DTS [3/2]	_____ <input type="checkbox"/> L <input type="checkbox"/> C <input type="checkbox"/> R dts <input type="checkbox"/> LS <input type="checkbox"/> RS	_____ <input type="checkbox"/> L <input type="checkbox"/> C <input type="checkbox"/> R dts LS RS	_____ <input type="checkbox"/> L <input type="checkbox"/> c <input type="checkbox"/> R dts <input type="checkbox"/> LS <input type="checkbox"/> RS	_____ <input type="checkbox"/> L <input type="checkbox"/> c <input type="checkbox"/> R dts LS RS
2/0**	☆ DOLBY DIGITAL [2/0]	_____ <input type="checkbox"/> L <input type="checkbox"/> C <input type="checkbox"/> R <input checked="" type="checkbox"/> PRO LOGIC <input type="checkbox"/> S	_____ <input type="checkbox"/> L <input type="checkbox"/> C <input type="checkbox"/> R <input checked="" type="checkbox"/> PRO LOGIC s	_____ <input type="checkbox"/> L <input type="checkbox"/> c <input type="checkbox"/> R <input checked="" type="checkbox"/> PRO LOGIC <input type="checkbox"/> S	_____ <input type="checkbox"/> L <input type="checkbox"/> R
	☆ DOLBY PROLOGIC	_____ <input type="checkbox"/> L <input type="checkbox"/> C <input type="checkbox"/> R <input checked="" type="checkbox"/> PRO LOGIC <input type="checkbox"/> S	_____ <input type="checkbox"/> L <input type="checkbox"/> C <input type="checkbox"/> R <input checked="" type="checkbox"/> PRO LOGIC s	_____ <input type="checkbox"/> L <input type="checkbox"/> c <input type="checkbox"/> R <input checked="" type="checkbox"/> PRO LOGIC <input type="checkbox"/> S	_____ <input type="checkbox"/> L <input type="checkbox"/> R
	☆ PCM XX kHz***	_____ <input type="checkbox"/> L <input type="checkbox"/> R	_____ <input type="checkbox"/> L <input type="checkbox"/> R	_____ <input type="checkbox"/> L <input type="checkbox"/> R	_____ <input type="checkbox"/> L <input type="checkbox"/> R

* Signals with Dolby surround encoded flag OFF

** Signals with Dolby surround encoded flag ON

*** The sampling rate is displayed.

Notes

- The amplifier performs Pro Logic decoding and the display conforms to 2/0** when using the following movie sound modes with 2/0* or STEREO PCM format signals. (CINEMA A, B, C, V.M.DIMENS., and V.SEMI M.D.)
- When using music sound modes such as HALL or JAZZ CLUB with standard audio formats e.g., PCM, the amplifier creates rear signals from the front L and R signals. In this case, sound is output from the rear speakers, but output channel indicators for the rear speakers do not light.

Customizing Sound Fields

By adjusting the surround parameters, you can customize the sound fields to suit your particular listening situation.

Once you customize a sound field, the changes are stored in memory indefinitely (unless the amplifier is unplugged for about two weeks). You can change a customized sound field any time by making new adjustments to the parameters.

See the table on page 31 for the parameters available in each sound field.

To get the most from multi channel surround sound

Position your speakers and do the procedures described in “Multi Channel Surround Setup” starting on page 15 before you customize a sound field.

Adjusting the surround parameters

The SURR menu contains parameters that let you customize various aspects of the current sound field. The settings available in this menu are stored individually for each sound field.

- 1 Start playing a program source encoded with multi channel surround sound.
- 2 Press SURR repeatedly to select the parameter you want to adjust.
- 3 Press the +/- buttons to select the setting you want.
The setting is stored automatically.

Effect level (EFFECT)

Initial setting : (depends on sound mode)

This parameter lets you adjust the “presence” of the current surround effect.

Wall type (WALL)

Initial setting : midpoint

When sound is reflected off soft material, such as a curtain, the high frequency elements are reduced. A hard wall is highly reflective and does not significantly affect the frequency response of the reflected sound. This parameter lets you control the level of the high frequencies to alter the sonic character of your listening environment by simulating a softer (S) or harder (H) wall. The midpoint designates a neutral wall (made of wood).

Reverberation (REVB.)

Initial setting : midpoint

Before sound reaches our ears, it is reflected (reverberated) many times between the left and right walls, ceiling, and floor. In a large room, sound takes more time to bounce from one surface to another than in a smaller room. This parameter lets you control the spacing of the early reflections to simulate a sonically larger (L) or smaller (S) room.

- The reverberation can be adjusted from REVB. S. 1 ~ REVB. S. 8 (short) to REVB. L. 1 ~ REVB. L. 8 (long) in 17 steps.
- The midpoint (REVB. MID) designates a standard room with no adjustment.

Customizing Sound Fields

Adjusting the level parameters

The LEVEL menu contains parameters that let you adjust the balance and speaker volumes of each speaker. The settings available in this menu are applied to all sound fields.

- 1 Start playing a program source encoded with multi channel surround sound.
- 2 Press LEVEL repeatedly to select the parameter you want to adjust.
- 3 Press the +/- buttons to select the setting you want.
The setting is stored automatically.

*Front balance (L/R)

Initial setting : balance

Lets you adjust the balance between the front left and right speakers.

- The balance can be adjusted ± 8 steps.
- These settings can also be adjusted using the supplied remote. See “Adjusting the speaker volume” (page 18).

*Rear balance (LS/RS)

Initial setting : balance

Lets you adjust the balance between the rear left and right speakers.

- The balance can be adjusted ± 8 steps.
- These settings can also be adjusted using the supplied remote. See “Adjusting the speaker volume” (page 18).

*Rear level (REAR)

Initial setting : 0 dB

Lets you adjust level of the rear (left and right) speakers.

- The level can be adjusted in 1 dB steps from -10 dB to +6 dB.
- These settings can also be adjusted directly using the supplied remote. See “Adjusting the speaker volume” (page 18).

*Center level (CTR)

Initial setting : 0 dB

Lets you adjust the level of the center speaker.

- The level can be adjusted in 1 dB steps from -10 dB to +6 dB.

*Sub woofer level (S.W. xx)

Initial setting : 0 dB

Lets you adjust the level of the sub woofer.

- The level can be adjusted in 1 dB steps from -10 dB to +6 dB.

** The parameters can be adjusted separately for 5.1 CH/SAT.*

Resetting customized sound fields to the factory settings

- 1 If the power is on, press I/⏻ to turn off the power.
- 2 Hold down SOUND FIELD MODE and press I/⏻.
“SURR. CLR.” appears in the display and all sound fields are reset at once.

Adjustable parameters for each sound field

	EFFECT LEVEL	WALL TYPE	REVERB TIME	FRONT BAL.	REAR BAL.	REAR LEVEL	CENTER LEVEL	SUB WOOFER LEVEL
2CH				●				●
A.F.D.				●	●	●	●	●
NORMAL SURROUND				●	●	●	●	●
CINEMA STUDIO A	●			●	●	●	●	●
CINEMA STUDIO B	●			●	●	●	●	●
CINEMA STUDIO C	●			●	●	●	●	●
V. MULTI DIMENSION				●	●	●	●	●
V. SEMI-M. DIMENSION				●			●	●
HALL	●	●	●	●	●	●	●	●
JAZZ CLUB	●	●	●	●	●	●	●	●
LIVE HOUSE	●	●	●	●	●	●	●	●
GAME	●	●	●	●	●	●	●	●
5.1CH/SAT				●	●	●	●	●

Other Operations

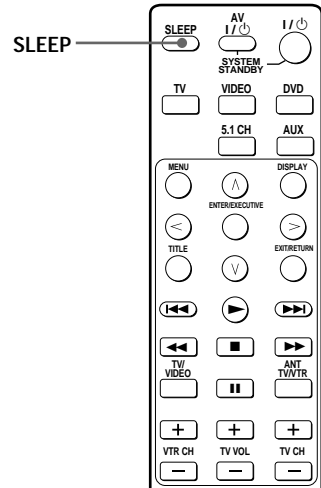

Brief descriptions of buttons that appear in this chapter

SLEEP button: Press to set the amplifier off automatically at a specified time.

Using the Sleep Timer

You can set the amplifier to turn off automatically at a specified time.

Press **SLEEP** on the remote while the power is on. Each time you press **SLEEP**, the time changes as shown below.

→ 2:00:00 → 1:30:00 → 1:00:00 → 0:30:00 → OFF →

The display dims after you have specified the time.

 You can freely specify the time

First, press **SLEEP** on the remote, then specify the time you want using the +/- buttons. The sleep time changes in 1 minute intervals. You can specify up to 5 hours.

 You can check the time remaining before the amplifier turns off

Press **SLEEP** on the remote. The remaining time appears in the display.

Additional Information

Troubleshooting

If you experience any of the following difficulties while using the amplifier, use this troubleshooting guide to help you remedy the problem. Also, see “Checking the connections” on page 20 to verify that the connections are correct. Should any problem persist, consult your nearest Sony dealer.

There’s no sound or only a very low-level sound is heard.

- ➔ Check that the speakers and components are connected securely.
- ➔ Make sure that you’ve selected the correct component on the amplifier.
- ➔ Press MUTING on the remote if MUTING appears on the display.
- ➔ The protective device on the amplifier has been activated because of a short circuit. Turn off the amplifier, eliminate the short-circuit problem and turn on the power again.

The left and right sounds are unbalanced or reversed.

- ➔ Check that the speakers and components are connected correctly and securely.
- ➔ Adjust front balance parameter in the LEVEL menu.

Severe hum or noise is heard.

- ➔ Check that the speakers and components are connected securely.
- ➔ Check that the connecting cords are away from a transformer or motor, and at least 3 meters (10 feet) away from fluorescent light.
- ➔ Move your TV away from the audio components.
- ➔ The plugs and jacks are dirty. Wipe them with a cloth slightly moistened with alcohol.

No sound is heard from the center speaker.

- ➔ Make sure the sound field function is on (press SOUND FIELD MODE).
- ➔ Select a sound field containing the word “cinema” or “virtual” (see pages 24 - 26).
- ➔ Adjust the speaker volume (see page 18).
- ➔ Select MICRO SP. from the SET UP menu (see page 15).

No sound or only a very low-level sound is heard from the rear speakers.

- ➔ Make sure the sound field function is on (press SOUND FIELD MODE).
- ➔ Select a sound field containing the word “cinema” or “virtual” (see pages 24 - 26).
- ➔ Adjust the speaker volume (see page 18).
- ➔ Select MICRO SP. from the SET UP menu (see page 15).

No sound is heard from the sub woofer.

- ➔ Select MICRO SP. from the SET UP menu (see page 15).

The surround effect cannot be obtained.

- ➔ Make sure the sound field function is on (press SOUND FIELD MODE).

The remote does not function.

- ➔ Point the remote at the remote sensor  on the amplifier.
- ➔ Remove any obstacles in the path between the remote and the amplifier.
- ➔ Replace both batteries in the remote with new ones, if they are weak.
- ➔ Make sure you select the correct function on the remote.
- ➔ If the remote is set to operate the TV only, use the remote to select a source or component other than TV before operating the amplifier or other component.

Reference sections for clearing the amplifier's memory

To clear	See
All memorized settings	page 14
Customized sound fields	page 31

Specifications

Amplifier section

POWER OUTPUT

Rated Power Output at Stereo mode
(8 ohms 1 kHz, THD
0.7%)
25 W + 25 W

Reference Power Output
(8 ohms 1 kHz, THD
0.7%)
Front: 25 W + 25 W
Center: 25 W
Rear: 25 W + 25 W

Frequency response

DVD, TV, VIDEO, AUX:
20 Hz - 20 kHz + 0.5/
-2 dB

Inputs (Analog)

5.1CH/SAT, TV, VIDEO:
Sensitivity: 250 mV
Impedance: 50
kilohms
S/N^{a)}: 96 dB (A, 250
mV^{b)})

a) *INPUT SHORT*

b) *Weighted network, input level*

Inputs (Digital)

DVD, AUX (optical):
Sensitivity: –
Impedance: –
S/N: 100 dB (A, 20
kHz LPF)

Outputs

SUB WOOFER:
Voltage: 2 V
Impedance: 1
kilohms

General

Power requirements
220-230 V AC, 50/60 Hz

Power consumption
120 W

Dimensions 296.5 × 215 × 60 mm
including projecting
parts and controls

Mass (Approx.)
4.2 kg

Speaker Section

SS-MS215 Front, center and rear speakers

Speaker system
Full range, magnetically shielded

Speaker units
5 cm cone type

Enclosure type
Bass reflex

Rated impedance
8 ohms

Power handling capacity (Maximum input power)
60 watts

Sensitivity level
84 dB (1 W, 1m)

Frequency range
150 Hz - 20,000 Hz

Dimensions (w/h/d)
Approx. 76 x 100 x 86mm including front grille

Mass
Approx. 425 g

SA-WMS215 subwoofer

System Speaker system
Active subwoofer, magnetically shielded

Speaker unit
Woofer: 16 cm cone type

Enclosure type
Acoustically Loaded Bass Reflex

Continuous RMS power output (8 ohms, 20 - 250 Hz)
50 W

Reproduction frequency range
32 Hz - 250 Hz

High frequency cut-off frequency
250 Hz

Input

LINE IN (input pin jack)

General

Power requirements
220 - 230 V AC, 50/60 Hz

Power consumptions
45 W

Dimensions (w/h/d)
Approx. 240 x 285 x 355mm including front panel

Mass
Approx. 8 kg

Supplied accessories
See page 4.

Design and specifications are subject to change without notice.

Specification indicated are measured at 230 V AC, 50 Hz.

Glossary

Surround sound

Sound that consists of three elements: direct sound, early reflected sound (early reflections) and reverberative sound (reverberation). The acoustics of the surrounding space affect the way these three sound elements are heard. Surround sound combines these sound elements in such a way that you actually can sense the size of the venue, as well as its type.

- Types of sound

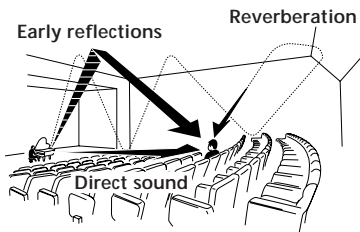

- Transition of sound from rear speakers

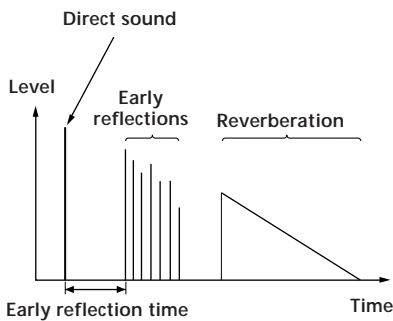

Dolby Pro Logic Surround

As one method of decoding Dolby Surround, Dolby Pro Logic Surround produces four channels from two-channel sound. Compared with the former Dolby Surround system, Dolby Pro Logic Surround reproduces left-to-right panning more naturally and localizes sounds more precisely. To take full advantage of Dolby Pro Logic Surround, you should have one pair of rear speakers and a center speaker. The rear speakers output monaural sound.

Dolby Digital (AC-3)

This sound format for movie theaters is more advanced than Dolby Pro Logic Surround. In this format, the rear speakers output stereo sound with an expanded frequency range and a sub woofer channel for deep bass is independently provided. This format is also called "5.1" because the sub woofer channel is counted as 0.1 channel (since it functions only when a deep bass effect is needed). All six channels in this format are recorded separately to realize superior channel separation. Furthermore, since all the signals are processed digitally, less signal degradation occurs. The name "AC-3" comes from the fact that it is the third audio coding method to be developed by the Dolby Laboratories Licensing Corporation.

Digital Cinema Sound

This is the generic name of the surround sound produced by digital signal processing technology developed by Sony. Unlike previous surround sound fields mainly directed at the reproduction of music, Digital Cinema Sound is designed specifically for the enjoyment of movies.

Settings Using SURR, LEVEL, and SET UP buttons

You can make various settings using the LEVEL, SURR, SET UP buttons, and + /- buttons. The table below shows each of the settings that these buttons can make.

Press	Press button repeatedly to select	Press + /- button to select	See page
SURR button	EFFECT LEVEL	depends on sound mode (in 16 steps)	29
	WALL TYPE	between -8 to +8 (in 1 increment steps)	
	REVERBERATION TIME	between -8 to +8 (in 1 increment steps)	
LEVEL button	FRONT BALANCE	between -8 to +8 (in 1 increment steps)	30
	REAR BALANCE	between -8 to +8 (in 1 increment steps)	
	REAR LEVEL	between -10 dB to +6 dB (in 1 dB steps)	
	CENTER LEVEL	between -10 dB to +6 dB (in 1 dB steps)	
	SUB WOOFER LEVEL	between -10 dB to +6 dB (in 1 dB steps)	
SET UP	* Speaker type	NORM. SP. or MICRO SP.	15
	[L] [R] (FRONT)	LARGE or SMALL	
	[C] (CENTER)	LARGE, SMALL, or NO	
	[LS] [RS] (REAR)	LARGE, SMALL, or NO	
	REAR PL.	PL. SIDE or PL. BEHD.	
	REAR HGT.	HGT. LOW or HGT. HIGH	
	SUB WOOFER	S.W. YES or S.W. NO	
	[L] [R] (FRONT) XX.X METER	between 3 feet (1.0 meters) and 40 feet (12.0 meters) (in 1 foot (0.1 meter) steps)	
	[C] (CENTER) XX.X METER	between FRONT and 5 feet (1.5 meters) (in 1 foot (0.1 meter) steps)	
[LS] [RS] (REAR) XX.X METER	between FRONT and 15 feet (4.5 meters) (in 1 foot (0.1 meter) steps)		

* When you press the SET UP button, you can select NORM. SP. (for normal speakers) or MICRO SP. (for Micro Satellite speakers). (page 15)

Remote Button Description

For buttons not described on previous pages and buttons with names different from the buttons on the main unit.

Remote Button	Operations	Function
◀◀/▶▶	VCR/DVD/ CD/LDP	Fast forward or rewinds.
◀◀/▶▶	DVD/CD/ LDP	Skips tracks.
⏸	VCR/DVD/ CD/LDP	Pauses play.
▶	VCR/DVD/ CD/LDP	Starts play.
■	VCR/DVD/ CD/LDP	Stops play.
AV/ I/⏻	TV/VCR/ DVD/LDP	Turns on or off the power.
ENTER/ EXECUTE	TV/VCR/ DVD	Confirm setting.
ANT TV/ VCR	VCR	Selects outputs signal from the antenna terminal: TV signal or VCR programme.
MENU	TV/VCR/ DVD	Display menu. programs.
TITLE	DVD	Display current DVD title.
EXIT/ RETURN	TV/DVD	Exit from menu mode or return to previous screen.
DISPLAY	TV/DVD/ LDP	Selects information displayed on the TV screen.
^	TV/VCR/ DVD	To increase a value or move the cursor upwards on the menu screen such as VIDEO CONTROL/ AUDIO CONTROL/ SET UP/ LANGUAGE/ DEMO
v	TV/VCR/ DVD	To decrease the value or move the cursor downwards on the menu screen such as VIDEO CONTROL/AUDIO CONTROL/SET UP/ LANGUAGE/DEMO
>	TV/VCR/ DVD	To move the cursor to the right side of the menu screens.
<	TV/VCR/ DVD	To move the cursor to the left side of the menu screen.

Remote Button	Operations	Function
VTR CH +/-	VCR	VCR channel selection.
TV CH +/-	TV	TV channel selection.
TV VOL +/-	TV	To adjust the TV volume.

* The menu control keys may not operate on certain Sony TVs.

Changing the factory setting of a function button

If the factory settings of the SYSTEM CONTROL/FUNCTION buttons don't match your system components, you can change them. The following table shows the possibility of alternate function assignment for each button.

Button	Possible assignment
VIDEO	VTR1, VTR 2, VTR 3
DVD, AUX	DVD, LDP, CD

- Initial setting of VIDEO is VTR 3.
- Sony VCR's are operated with a VTR 1, 2, or 3 setting that corresponds to Beta, 8mm and VHS, respectively.

Resetting key table for function key VIDEO

VTR 1	CURSOR UP
VTR 2	ENTER/EXECUTE
VTR 3	CURSOR DOWN

Resetting key table for function key DVD, AUX

DVD	EXIT/RETURN
LD	DISPLAY
CD	CURSOR RIGHT

Note

There is no initial setting for AUX. You need to reset this key according to the equipment connected to the AUX input jack.

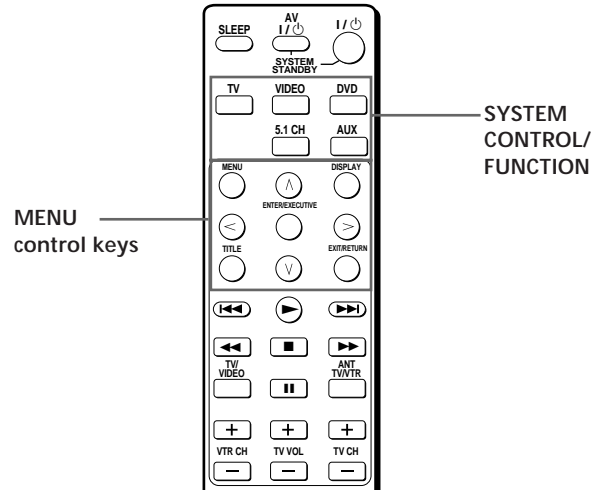

For example, if you connect a Sony LD player to the DVD jacks, you can assign the DVD button to set the remote to control the LD player.

- 1 Hold down the SYSTEM CONTROL/FUNCTION button whose function you want to change (DVD, for example).
- 2 Press the corresponding button of the component you want to assign to the SYSTEM CONTROL/FUNCTION button (DISPLAY, LD player, for example).

Now you can use the DVD button to control your Sony LD player.

To reset a button to its factory setting
Repeat the above procedure.

To reset all the function buttons to their factory setting
Press I/O, AV I/O and MASTER VOL - at the same time.

Index

A

- AC-3. *See* *Dolby Digital (AC-3)*
- Adjusting
 - speaker volumes 18
 - surround parameters 29

B

- Basic amplifier operations
 - 21 - 22
- Batteries 4

C

- Changing
 - effect level 29
- Checking the connections 20
- Clearing amplifier's memory 14
- Connecting. *See* *Hookups*
- Customizing sound fields 29

D

- Demonstration mode 3
- Dolby Digital (AC-3) 38
- Dolby Pro Logic Surround 38

E, F, G

- Effect level 29

H

- Hookups
 - 5.1CH/SAT 8
 - AC power cord 9
 - digital components 7
 - speaker system 11
 - video components 6

P, Q

- Parameter 29, 30, 31

S

- Selecting
 - component 21
 - sound field 24
- Sleep timer 33
- Sound field
 - adjustable parameters 31
 - customizing 29
 - pre-programmed 24 - 26
 - resetting 31
 - selecting 24
- Speakers
 - adjusting speaker volume 18
 - connection 11
 - placement 15
- Supplied accessories 4
- Surround sound 15 - 18, 23 - 31

T

- Troubleshooting 34

U, V, W, X, Y, Z

- Unpacking 4

