

# ***Compact Hi-Fi Stereo System***

---

## Operating Instructions

### Owner's Record

The model and serial numbers are located on the rear panel. Record the serial number in the space provided below. Refer to them whenever you call upon your Sony dealer regarding this product.

Model No. \_\_\_\_\_ Serial No. \_\_\_\_\_



***LBT-LX8***

***LBT-LX7***

***LBT-LX6***

***LBT-LX5***

***LBT-LX50***

***LBT-LX30***

## WARNING

**To prevent fire or shock hazard, do not expose the unit to rain or moisture.**

To avoid electrical shock, do not open the cabinet. Refer servicing to qualified personnel only.

Do not install the appliance in a confined space, such as a bookcase or built-in cabinet.

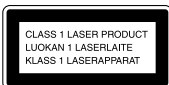

This appliance is classified as a CLASS 1 LASER product. The CLASS 1 LASER PRODUCT MARKING is located on the rear exterior.

## NOTICE FOR THE CUSTOMERS IN THE U.S.A.

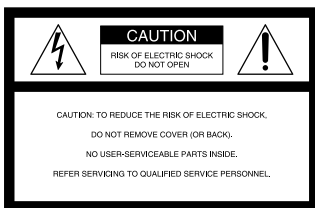

This symbol is intended to alert the user to the presence of uninsulated "dangerous voltage" within the product's enclosure that may be of sufficient magnitude to constitute a risk of electric shock to persons.



This symbol is intended to alert the user to the presence of important operating and maintenance (servicing) instructions in the literature accompanying the appliance.

## CAUTION

The use of optical instruments with this product will increase eye hazard.

## INFORMATION

This equipment has been tested and found to comply with the limits for a Class B digital device, pursuant to Part 15 of the FCC Rules. These limits are designed to provide reasonable protection against harmful interference in a residential installation. This equipment generates, uses, and can radiate radio frequency energy and, if not installed and used in accordance with the instructions, may cause harmful interference to radio communications. However, there is no guarantee that interference will not occur in a particular installation. If this equipment does cause harmful interference to radio or television reception, which can be determined by turning the equipment off and on, the user is encouraged to try to correct the interference by one or more of the following measures:

- Reorient or relocate the receiving antenna.
- Increase the separation between the equipment and receiver.
- Connect the equipment into an outlet on a circuit different from that to which the receiver is connected.
- Consult the dealer or an experienced radio/TV technician for help.

## CAUTION

You are cautioned that any changes or modifications not expressly approved in this manual could void your authority to operate this equipment.

## NOTICE FOR THE CUSTOMERS IN CANADA

### CAUTION:

TO PREVENT ELECTRIC SHOCK, DO NOT USE THIS POLARIZED AC PLUG WITH AN EXTENSION CORD, RECEPTACLE OR OTHER OUTLET UNLESS THE BLADES CAN BE FULLY INSERTED TO PREVENT BLADE EXPOSURE.

## for the customers in North America



ENERGY STAR® is a U.S. registered mark.

As ENERGY STAR® Partner, Sony Corporation has determined that this product meets the ENERGY STAR® guidelines for energy efficiency.

This stereo system is equipped with the Dolby® B-type noise reduction system.

\* Dolby noise reduction manufactured under license from Dolby Laboratories Licensing Corporation. "DOLBY" and the double-D symbol  are trademarks of the Dolby Laboratories Licensing Corporation.

(LBT-LX7/LX5 only)



AR46

---

# Table of Contents

---

## Getting Started

Step 1: Using this manual .....	4
Step 2: Hooking up the system .....	5
Step 3: Setting the time .....	7
Step 4: Presetting radio stations .....	8
Saving power in standby mode* .....	10

## Sound Adjustment

Adjusting the sound .....	28
Selecting the audio emphasis .....	29
Adjusting the audio emphasis .....	30
Making a personal audio emphasis file .....	32

## Basic Operations

Playing a CD .....	11
Recording a CD .....	12
Listening to the radio .....	13
Recording from the radio .....	15
Playing a tape .....	16
Recording from a tape .....	18

## Other Features

Using the Radio Data System (RDS)** .....	33
Singing along: Karaoke .....	35
Falling asleep to music .....	37
Waking up to music .....	38
Timer-recording radio programs .....	39

## The CD Player

Using the CD display .....	19
Playing CD tracks repeatedly .....	20
Playing CD tracks in random order ..	20
Programming CD tracks .....	21
Playing CDs without interruption .....	23

## Optional AV Components

Connecting audio components .....	41
Connecting video components .....	43
Connecting outdoor antennas .....	44

## The Tape Deck

Recording on a tape manually .....	24
Recording CDs by specifying the track order .....	25

## Additional Information

Precautions .....	45
Troubleshooting .....	47
Specifications .....	49
Index .....	Back Cover

## DJ Effects

Looping part of a CD .....	27
Flashing part of a CD .....	27

\* For LBT-LX50/LX30/LX7/LX5  
only

\*\*For European models only

## Step 1: Using this manual

The instructions in this manual are for LBT-LX50/LX30/LX8/LX7/LX6/LX5. The LBT-LX6 is the model used for illustration purposes. Any difference in operation is clearly indicated in the text, for example, "LBT-LX7/LX5 only" or "For European models."

Wide display is used for LBT-LX8/LX7 and normal display is used for LBT-LX50/LX30/LX6/LX5.

Wide display for LBT-LX8/LX7

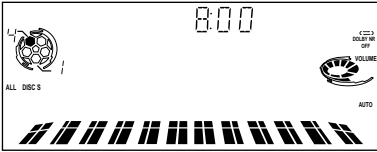

Normal display for LBT-LX50/LX30/LX6/LX5



The instructions in this manual describe the controls on the player. You can also use the controls on the remote if they have the same or similar names as those on the player.

Before operating the system, please read this manual thoroughly and retain it for future reference.

### Notice for customers in the United Kingdom

The AC power cord has been fixed temporarily on the rear panel with the plug band for shipment.

Unlock the plug band to remove the plug.

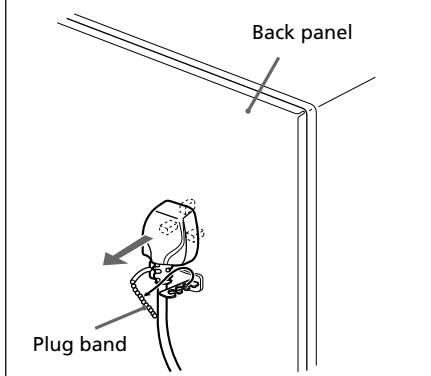

# Step 2: Hooking up the system

Follow steps **1** through **4** to hook up your system using the supplied cords and accessories.

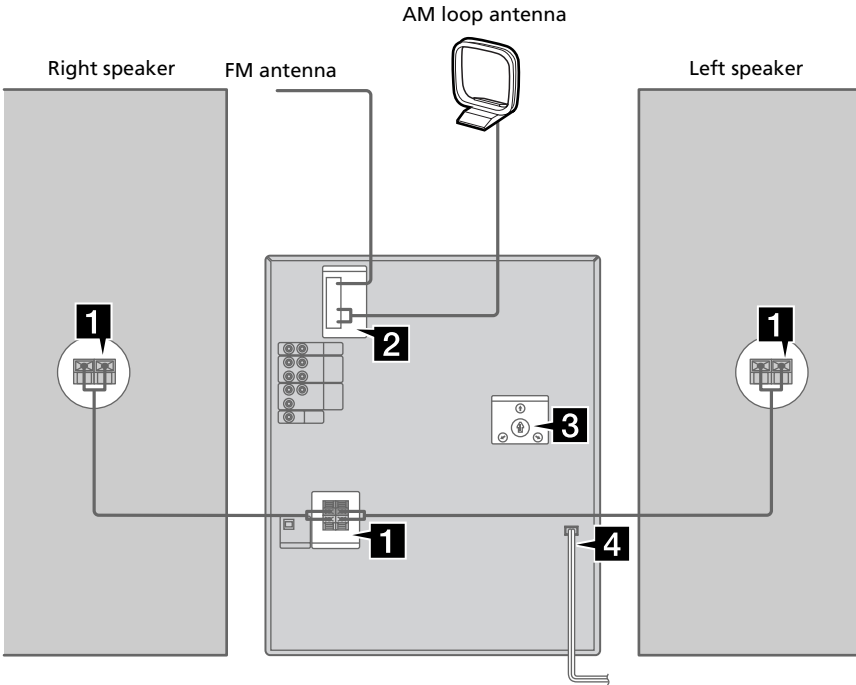

The above illustration is of the LBT-LX6.

## **1** Connect the speakers.

**1** Connect the speaker cords to FRONT SPEAKER jacks.

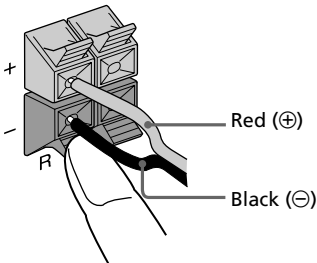

**2** Insert only the stripped portion of the cord. Inserting the vinyl portion will interfere with the speaker connection and no sound will come from the speaker.

### **Note**

Keep the speaker cords away from the antennas to prevent noise.

## Step 2: Hooking up the system (continued)

- 2** Connect the FM/AM antennas.  
Set up the AM loop antenna, then connect it.

### Jack type ①

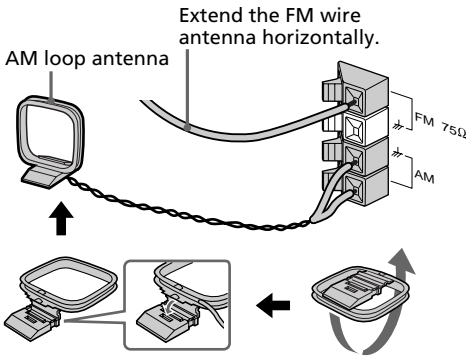

### Jack type ②

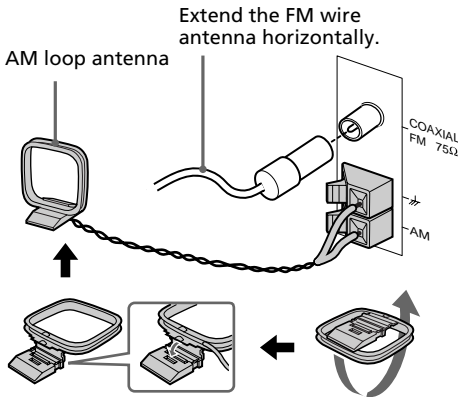

- 3** If your system has a VOLTAGE SELECTOR on the rear panel, set it to the position of your local power line voltage.

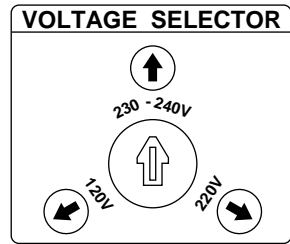

- 4** Connect the power cord to a wall outlet.

The demonstration appears in the display. When you press I/⏻, the system turns on and the demonstration automatically stops.

If the supplied adapter on the plug does not fit your wall outlet, detach it from the plug (only for models equipped with an adapter).

## To connect optional AV components

See page 41.

## To deactivate the demonstration

When you set the time (see “Step 3 Setting the time”), the demonstration is deactivated.

To activate/deactivate the demonstration again, press DISPLAY (for LBT-LX50/LX30/LX7/LX5) or DEMO (STAND BY) (for other models) while the system is off.

## Inserting two R6 (size AA) batteries into the remote

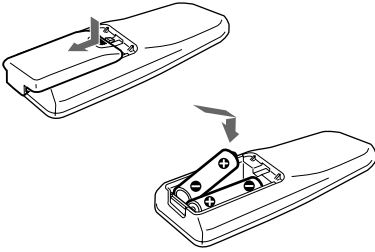

### Tip

With normal use, the batteries should last for about six months. When the remote no longer operates the system, replace both batteries with new ones.

### Note

If you do not use the remote for a long period of time, remove the batteries to avoid possible damage from battery leakage.

## When carrying this system

Do the following to protect the CD mechanism.

Make sure that all discs are removed from the unit.

- 1 Press FUNCTION repeatedly until "CD" appears in the display.
- 2 Hold down LOOP and press I/⏻ to turn off the system.  
"LOCK" appears in the display. It is now safe for transportation.

## Step 3: Setting the time

You must set the time before using the timer functions. The clock is on a 24-hour system for European models, and a 12-hour system for other models.

The 24-hour system model is used for illustration purposes.

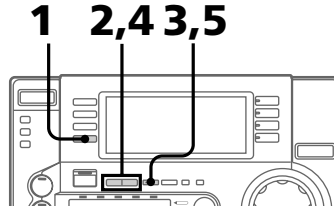

- 
- 1 Press /CLOCK SET.  
The hour indication flashes.



- 
- 2 Press TUNING +/- to set the hour.



- 
- 3 Press ENTER/NEXT.  
The minute indication flashes.



- 
- 4 Press TUNING +/- to set the minute.

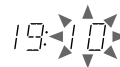

- 
- 5 Press ENTER/NEXT.  
The clock starts.
-

### Step 3: Setting the time (continued)

#### Tip

If you make a mistake, start over from step 1.

#### To change the time

The previous explanation shows you how to set the time while the power is off. To change the time while the power is on, do the following:

- 1 Press  $\odot$ /CLOCK SET.
- 2 Press TUNING +/- to select SET CLOCK.
- 3 Press ENTER/NEXT.
- 4 Perform steps 2 through 5 in the previous explanation.

#### Notes

- You cannot set the time in Power Saving mode (LBT-LX50/LX30/LX7/LX5 only, see page 10).
- The clock setting is canceled when you disconnect the power cord or if a power failure occurs.

## Step 4: Presetting radio stations

You can preset the following number of stations:

— 20 for FM and 10 for AM

The bands you can select depend on the kind of tuner built into your system. Confirm the bands by pressing TUNER/BAND repeatedly.

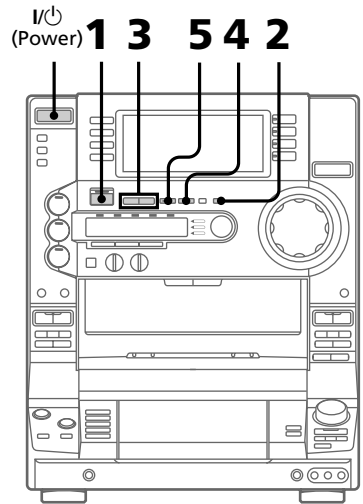

- 1 Press TUNER/BAND repeatedly until the desired band appears in the display.

Each time you press this button, the band changes as follows:

FM  $\leftrightarrow$  AM



---

**2** Press TUNING MODE repeatedly until "AUTO" appears in the display.

---

**3** Press TUNING +/-.

The frequency indication changes and scanning stops when the system tunes in a station. "TUNED" and "STEREO" (for a stereo program) appear.

**Wide display**

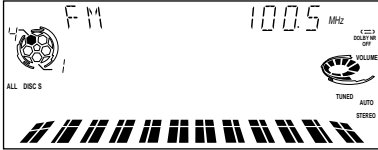

**Normal display**



---

**4** Press TUNER MEMORY.

The next available preset number flashes in the display. The stations are stored from preset number 1.

**Wide display**

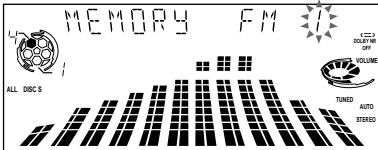

**Normal display**



---

**5** Press ENTER/NEXT.

The station is stored.

---

**6** Repeat steps 1 through 5 to store other stations.

---

**To tune in a station with a weak signal**

Press TUNING MODE repeatedly until "MANUAL" appears in step 2, then press TUNING +/- to tune in a station.

**To store another station on an existing preset number**

Start over from step 1. After step 4, press TUNING +/- to select the preset number on which you want to store the station.

You can add a new preset number after the last preset number.

**To erase a preset number**

- 1 Press and hold TUNER MEMORY until a preset number flashes in the display.
- 2 Press TUNING +/- to select the preset number you want to erase. Select "ALL ERASE" to erase all preset numbers.
- 3 Press ENTER/NEXT.

When you erase a preset number, all the following preset numbers shift up and reduce by one.

**To change the AM tuning interval (Except for European and Middle Eastern models)**

The AM tuning interval is factory-preset to 9 kHz (10 kHz in some areas). To change the AM tuning interval to 10 kHz (or 9 kHz), press TUNER/BAND repeatedly until "AM" appears, then turn off the system. While holding down ENTER, turn the system back on. When you change the interval, the AM preset stations will be erased. To reset the interval, repeat the same procedure.

**Note**

The preset stations are canceled when you disconnect the power cord or if a power failure occurs for more than half a day.

---

# Saving power in standby mode (For LBT-LX50/LX30/LX7/LX5 only)

In standby mode, you can reduce the power consumption to a minimum (Power Saving mode) and save energy in standby mode.

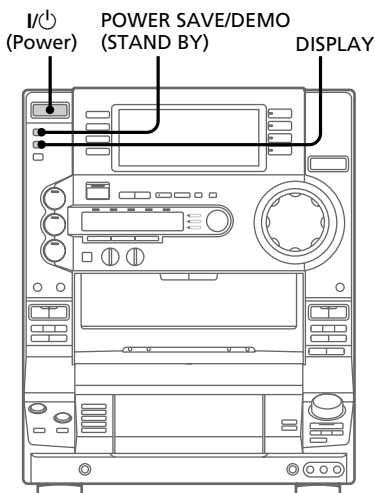

---

➔ Press POWER SAVE/DEMO (STAND BY) while the system is turned off.

The system switches to the Power Saving mode and the clock display disappears.

The system is turned on/off by pressing I/⏻.

---

## To cancel the Power Saving mode

Press DISPLAY.

The clock display reappears.

## Tips

- Each time you press POWER SAVE/DEMO (STAND BY) in the Power Saving mode, the display switches between the Power Saving mode and the demo mode.
- The I/⏻ indicator and timer indicator (when the timer is set) light up even in the Power Saving mode.
- The timer works in the Power Saving mode.

## Notes

- You cannot set the time in the Power Saving mode.
- The One Touch Play function does not work in the Power Saving mode.

## Playing a CD

### — Normal Play

You can play up to five CDs in a row.

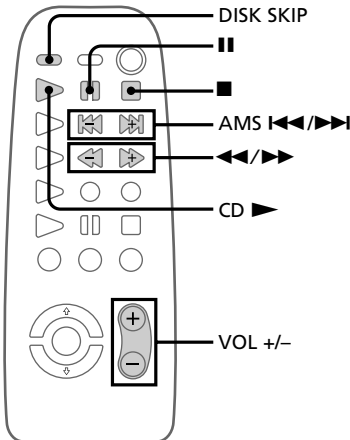
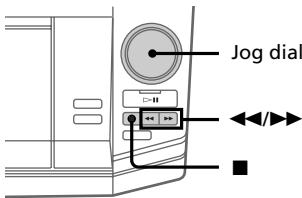
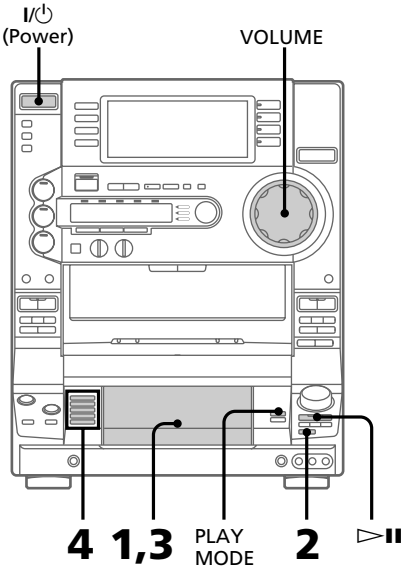

- 1** Press PUSH OPEN and place a CD on the disc tray.

If the disc is not placed properly, it will not be recognized.

With the label side up. When you play a CD single, place it on the inner circle of the tray.

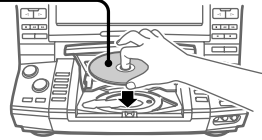

- 2** Press DISC SKIP to place up to four more CDs on the tray.

The disc tray rotates so that you can insert other CDs.

- 3** Close the front cover.

- 4** Press one of the DISC 1 - DISC 5 buttons.

Playback starts.

If you press ▷|| (or CD ▷ on the remote), playback starts from the CD in the playing position.

#### Wide display

Disc number in the playing position

Track number Elapsed time

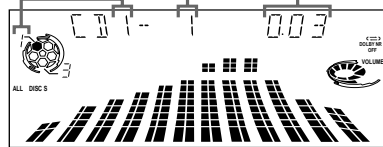

#### Normal display

Disc number in the playing position

Track number Elapsed time

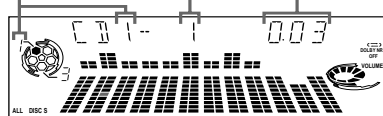

## Playing a CD (continued)

To	Do this
Stop playback	Press ■.
Pause	Press ▷   (or    on the remote). Press ▷   again to resume playback (or CD ► on the remote).
Select a track	During playback or pause, turn the jog dial clockwise (to go forward) or counterclockwise (to go backward) and release it when you reach the desired track. Or press AMS* ►► (to go forward) or AMS ◄◄ (to go backward) on the remote.
Find a point in a track	Press and hold ►► or ◄◄ during playback, and release at the desired point.
Select a CD	Press one of the DISC 1 - DISC 5 buttons (or DISC SKIP).
Play only the CD you have selected	Press PLAY MODE repeatedly until "1 DISC" appears.
Play all CDs	Press PLAY MODE repeatedly until "ALL DISCS" appears.
Remove or change the CDs	Press PUSH OPEN.
Adjust the volume	Turn VOLUME (or press VOL +/- on the remote).

\* AMS: Automatic Music Sensor

### Tips

- Pressing ▷|| while the system power is off automatically turns on the system and starts CD playback if there is a CD on the tray (One Touch Play). One Touch Play is not available in Power Saving mode.
- You can switch from another source and begin playing a CD just by pressing ▷||, one of the DISC 1 - DISC 5 buttons, or CD ► on the remote (Automatic Source Selection).
- If there is no CD in the player, "NO DISC" appears in the display.
- You can change the CD which is in the loading position during playback of the CD which is in the playing position.

## Recording a CD

### — CD Synchro Recording

This function lets you easily record from a CD to a tape. You can use TYPE I (normal) or TYPE II (CrO<sub>2</sub>) tapes. The recording level is automatically adjusted.

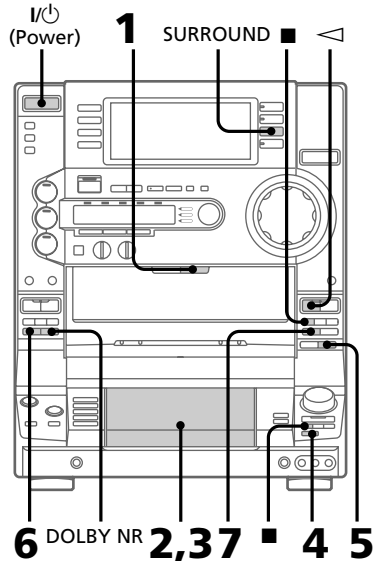

- 1 Press ▲ B EJECT and insert a recordable tape into deck B.

With the side you want to record on facing forward

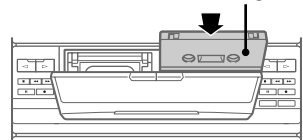

- 2 Press PUSH OPEN and place a CD.

With the label side up. When you play a CD single, place it on the inner circle of the tray.

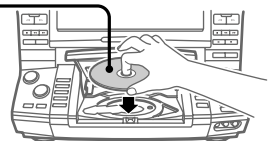

- 3 Close the front cover.
- 4 Press DISC SKIP repeatedly until the number of the disc you want to record from appears in the playing position indicator.
- 5 Press CD SYNC.  
Deck B stands by for recording, the CD player stands by for playback, and the indicator on the  $\triangleright$  button (for the front side) lights up green.
- 6 Press DIRECTION repeatedly until  $\rightleftarrows$  appears to record on one side, or  $\leftrightarrow$  (or RELAY) to record on both sides.
- 7 Press II.  
Recording starts.

### To stop recording

Press ■ on deck B or on the CD player.

### Tips

- When you want to record on the reverse side, press  $\triangleleft$  after pressing CD SYNC in step 5 so that the indicator on the  $\triangleleft$  button (for the reverse side) lights up green.
- When you record on both sides, be sure to start from the front side. If you start from the reverse side, recording stops at the end of the reverse side.
- When you want to reduce the hiss noise in low-level, high-frequency signals, press DOLBY NR before step 7 so that "DOLBY NR B" appears in the display.
- To record with the surround effect, press SURROUND so that "SUR ((((((■))))))" appears in the display.  
The equalizer settings will not be recorded.

### Note

You cannot listen to other sources while recording.

## Listening to the radio

### — Preset Tuning

Before using this function, preset radio stations in the tuner's memory (see "Step 4: Presetting radio stations" on page 8).

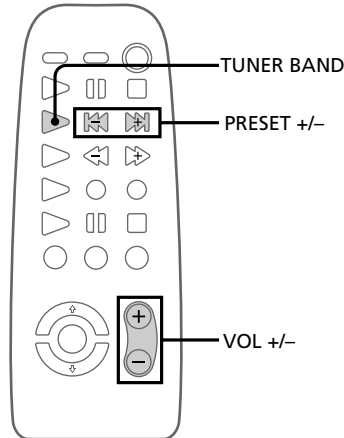
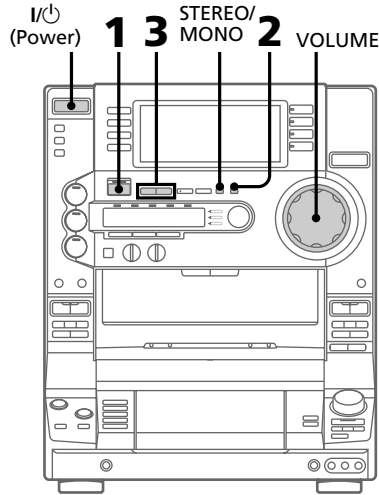

## Listening to the radio (continued)

- 1 Press TUNER/BAND repeatedly until the desired band appears in the display.

Each time you press this button, the band changes as follows:

FM ↔ AM

- 2 Press TUNING MODE repeatedly until "PRESET" appears in the display.

MANUAL → AUTO → PRESET



- 3 Press TUNING +/- (or PRESET +/- on the remote) to tune in the desired preset station.

### Wide display

Preset number\*      Frequency

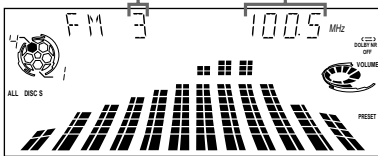

### Normal display

Preset number\*      Frequency

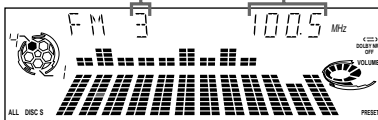

\* When only one station is preset, "ONE PRESET" appears in the display.

To	Do this
Turn off the radio	Press I/⏻.
Adjust the volume	Turn VOLUME (or press VOL +/- on the remote).

## To listen to non-preset radio stations

Press TUNING MODE repeatedly in step 2 until "MANUAL" appears, then press TUNING +/- to tune in the desired station.

### Tips

- Pressing TUNER/BAND while the system power is off automatically turns on the system and tunes in the last received station (One Touch Play). One Touch Play is not available in Power Saving mode.
- You can switch from another source to the radio by pressing TUNER/BAND (Automatic Source Selection).
- If an FM program is noisy, press STEREO/MONO so that "MONO" appears in the display. There will be no stereo effect, but the reception will improve. Press this button again to restore the stereo effect.
- To improve broadcast reception, move the supplied antennas.

# Recording from the radio

You can record a radio program onto a tape by tuning in a preset station. You can use TYPE I (normal) or TYPE II (CrO<sub>2</sub>) tapes. The recording level is automatically adjusted.

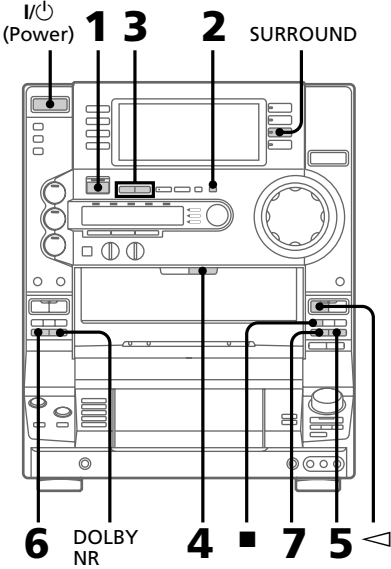

- 1 Press TUNER/BAND repeatedly until the desired band appears in the display.
- 2 Press TUNING MODE repeatedly until "PRESET" appears in the display.

- 3 Press TUNING +/- to tune in the desired preset station.

## Wide display

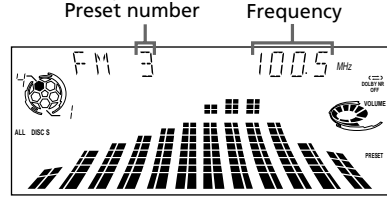

## Normal display

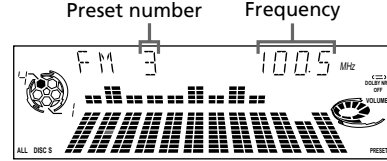

- 4 Press **B EJECT** and insert a recordable tape into deck B.  
With the side you want to record on facing forward

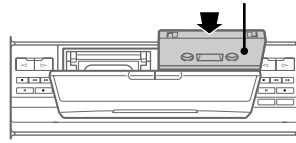

- 5 Press **REC**.  
Deck B stands by for recording, and the indicator on the **DIRECTION** button (for the front side) lights up green.
- 6 Press **DIRECTION** repeatedly until **↔** appears to record on one side, or **↔↔** (or **RELAY**) to record on both sides.
- 7 Press **II**.  
Recording starts.

## To stop recording

Press **■** on deck B.

## Recording from the radio (continued)

### Tips

- When you want to record on the reverse side, press ◀ after pressing ● REC in step 5 so that the indicator on the ◀ button (for the reverse side) lights up green.
- When you record on both sides, be sure to start from the front side. If you start from the reverse side, recording stops at the end of the reverse side.
- To record non-preset stations, select "MANUAL" in step 2, then press TUNING +/- to tune in the desired station.
- When you want to reduce the hiss noise in low-level, high-frequency signals, press DOLBY NR before step 7 so that "DOLBY NR B" appears in the display.
- To record with the surround effect, press SURROUND so that "SUR (|||||■||||)" appears in the display. The equalizer settings will not be recorded.
- To improve broadcast reception, move the supplied antennas.

## Playing a tape

You can play any type of tape, TYPE I (normal), TYPE II (CrO<sub>2</sub>), or TYPE IV (metal). The deck automatically detects the tape type. You can also use the AMS\* functions to quickly locate the desired songs.

To select either deck A or B, press DECK A ▶ or DECK B ▶ on the remote.

\* AMS: Automatic Music Sensor

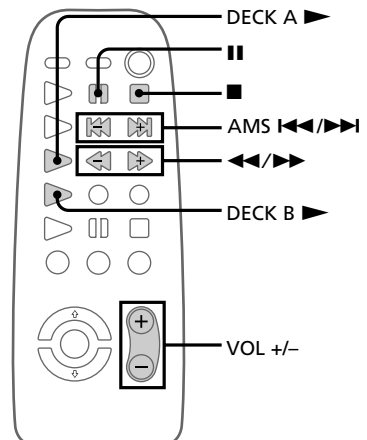
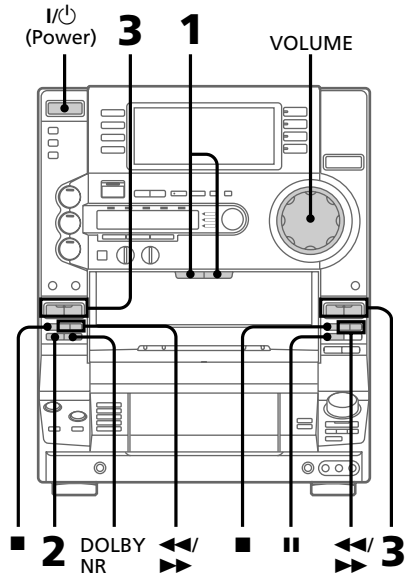



- 1 Press A EJECT  $\blacktriangle$  (or  $\blacktriangle$  B EJECT) and insert a recorded tape.

With the side you want to play facing forward

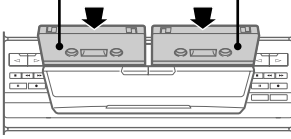

- 2 Press DIRECTION repeatedly to select  $\rightleftarrows$  to play one side,  $\leftrightarrow$  to play both sides, or RELAY (Relay Play)\* to play both decks in succession.

- 3 Press  $\triangleright$ .

Press  $\triangleleft$  to play the reverse side. The tape starts playing.

\* Relay Play always plays according to the following sequence:

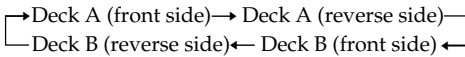

To	Do this
Stop play	Press $\blacksquare$ .
Pause (Deck B only)	Press $\mathbb{II}$ . Press again to resume playback.
Fast-forward	Press $\blacktriangleright\blacktriangleright$ or $\blacktriangleleft\blacktriangleleft$ .
Rewind	Press $\blacktriangleleft\blacktriangleleft$ or $\blacktriangleright\blacktriangleright$ .
Remove the cassette	Press A EJECT $\blacktriangle$ (or $\blacktriangle$ B EJECT).
Adjust the volume	Turn VOLUME (or press VOL +/- on the remote).

## To search for the beginning of a track (AMS)

Press  $\blacktriangleright\blacktriangleright$  to search forward or  $\blacktriangleleft\blacktriangleleft$  to search backward when playing the front side (or vice-versa when playing the reverse side). When you use the remote, AMS  $\blacktriangleleft\blacktriangleleft$  or  $\blacktriangleright\blacktriangleright$ .

The search direction, + (forward) or - (backward), and number of songs being skipped (1 - 9) appear in the display.

Example: searching forward 2 songs

T A P E A : : : + 2

### Tips

- Pressing  $\triangleright$  or  $\triangleleft$  while the system power is off automatically turns on the system and starts tape playback if there is a tape in the deck (One Touch Play). One Touch Play is not available in Power Saving mode.
- You can switch from another source to the tape deck by pressing  $\triangleright$  or  $\triangleleft$  (Automatic Source Selection).
- You can fast-forward or rewind the tape, regardless of the selected source.
- When you want to reduce the hiss noise in low-level, high-frequency signals, press DOLBY NR so that "DOLBY NR B" appears in the display.

### Notes

- The deck stops automatically after playing both sides five times.
- The AMS function may not operate correctly under the following circumstances:
  - When the unrecorded space between songs is less than 4 seconds long.
  - If completely different information is recorded on the left and right channels.
  - When there are continuous sections of extremely low level or low frequency sound (like those of a baritone sax).
  - When the system is placed near a TV. (In this case, we recommend moving the system farther away from the TV or turning off the TV.)

# Recording from a tape

## — High-speed Dubbing

You can use TYPE I (normal) or TYPE II (CrO<sub>2</sub>) tapes. The recording level is automatically adjusted.

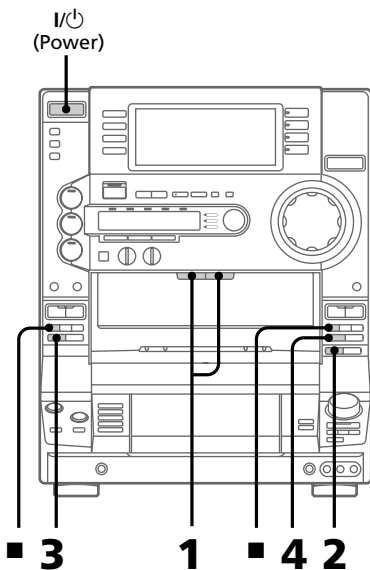

- 1 Press A EJECT and B EJECT and insert a recorded tape in deck A and a recordable tape in deck B.

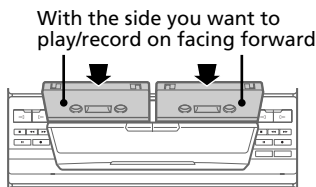

- 2 Press H SPEED DUB.  
Deck B stands by for recording.

- 3 Press DIRECTION repeatedly until appears to record on one side, or (or RELAY) to record on both sides.

- 4 Press .  
Dubbing starts.  
When dubbing ends, decks A and B automatically stop.

## To stop dubbing

Press on deck A or B.

### Tips

- When you record on both sides, be sure to start from the front side. If you start from the reverse side, recording stops at the end of the reverse side.
- You don't have to set DOLBY NR, since the tape in deck B is automatically recorded in the same state as the tape in deck A.

### Notes

- If you set DIRECTION to , when the tapes you use have different lengths, the tape in each deck reverses independently. If you select RELAY, the tapes in both decks reverse together.
- You cannot record the surround effect.

## Using the CD display

You can check the remaining time of the current track or that of the CD.

When a CD TEXT disc is loaded, you can check the information stored on the disc, such as the disc titles or artist names. When the system detects CD TEXT discs, "CD TEXT" appears in the display.

DISPLAY

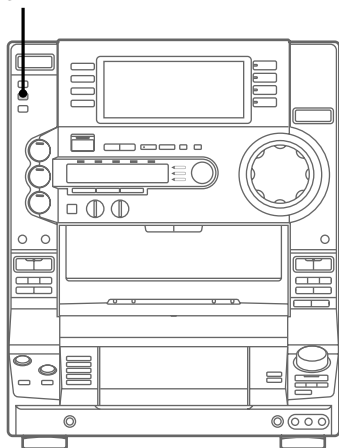

➔ Press DISPLAY.

Each time you press this button during Normal Play or in stop mode, the display changes as follows:

### During Normal Play

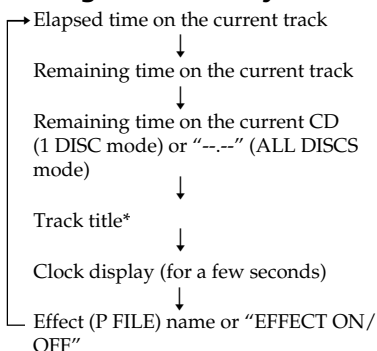

### In stop mode

In the program mode when there is a program

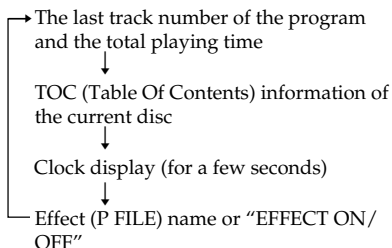

In other conditions

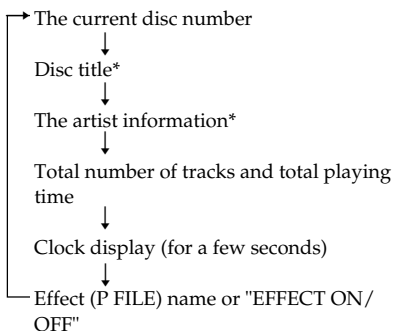

\* With CD TEXT discs only (certain characters cannot be displayed). When the CD contains more than 20 tracks, CD TEXT is not displayed from track 21 on.

### Notes

- The display may not show all the characters depending on the disc.
- This player can only display the disc titles, track titles and artist names from CD TEXT discs. Other information cannot be displayed.
- If a title or name has more than 12 characters, the first 12 characters will light up after the title or name scrolls by in the display.

# Playing CD tracks repeatedly

## — Repeat Play

This function lets you repeat a single CD or all CDs in Normal Play, Shuffle Play, and Program Play.

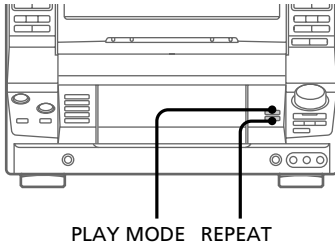

- ➔ Press REPEAT repeatedly during playback until “REPEAT” appears in the display.
- Repeat Play starts. The following table describes the various repeat modes.

To repeat	Press
All the tracks on the current CD	PLAY MODE repeatedly until “1 DISC” appears in the display.
All the tracks on all CDs	PLAY MODE repeatedly until “ALL DISCS” appears in the display.
Only one track	REPEAT repeatedly while playing the track you want to repeat until “REPEAT 1” appears in the display.

## To cancel Repeat Play

Press REPEAT repeatedly until “REPEAT” or “REPEAT 1” disappears from the display.

# Playing CD tracks in random order

## — Shuffle Play

You can play all the tracks on one or all CDs in random order.

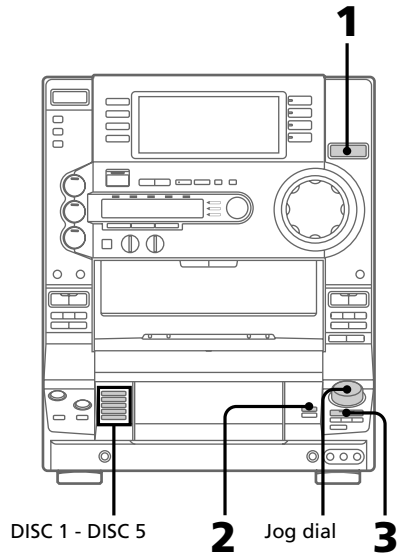

- 1 Press FUNCTION repeatedly until “CD” appears in the display.
- 2 Press PLAY MODE repeatedly until “ALL DISCS SHUFFLE” or “1 DISC SHUFFLE” appears in the display. “ALL DISCS SHUFFLE” shuffles the tracks on all the CDs in the player. “1 DISC SHUFFLE” shuffles the tracks on the CD in the playing position.
- 3 Press ▷||. All the tracks play in random order.

## To cancel Shuffle Play

Press PLAY MODE repeatedly until "ALL DISCS SHUFFLE," "1 DISC SHUFFLE," or "PROGRAM" disappears from the display. The tracks continue playing in their original order.

## To select the desired CD

Press one of the DISC 1 - DISC 5 buttons during 1 Disc Shuffle Play.

### Tips

- You can start Shuffle Play during Normal Play by pressing PLAY MODE repeatedly until "ALL DISCS SHUFFLE" or "1 DISC SHUFFLE" appears in the display.
- To skip a track, turn the jog dial clockwise (or press AMS ►► on the remote).

# Programming CD tracks

## — Program Play

You can create a program of up to 32 tracks from all the CDs in the order you want them to be played.

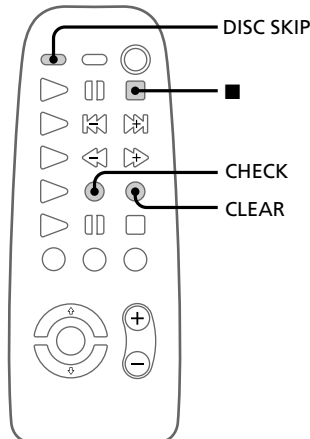
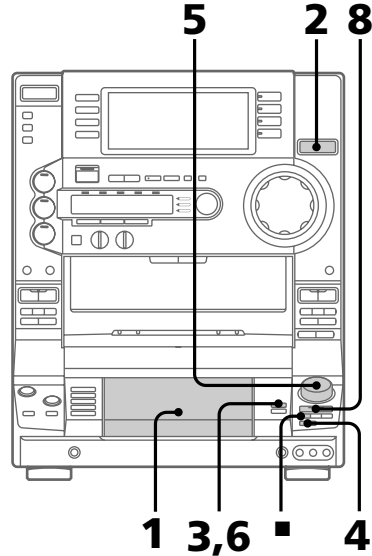

## Programming CD tracks (continued)

- 1 Place CDs and close the front cover.
- 2 Press FUNCTION repeatedly until "CD" appears in the display.
- 3 Press PLAY MODE repeatedly until "PROGRAM" appears in the display.
- 4 Press DISC SKIP to select a CD.
- 5 Turn the jog dial until the desired track appears in the display.

### Wide display

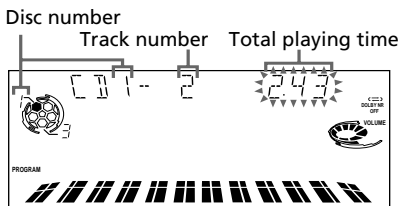

### Normal display

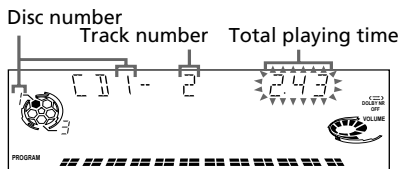

- 6 Press PLAY MODE once.  
The track is programmed. First "STEP" and the programmed playing order appear, then the total playing time appears.

### Wide display

The last programmed track      Total playing time

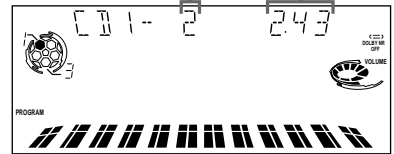

### Normal display

The last programmed track      Total playing time

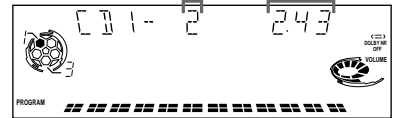

- 7 Repeat steps 4 through 6 to program additional tracks.  
Skip step 4 to select tracks from the same disc.
- 8 Press . All the tracks play in the order you selected.

## To cancel Program Play

Press PLAY MODE repeatedly until "PROGRAM," "ALL DISCS SHUFFLE," or "1 DISC SHUFFLE" disappears from the display.

To	Press
Check the program	CHECK on the remote repeatedly. After the last track, "CHECK END" appears.
Clear the last selected track	CLEAR on the remote in stop mode.
Clear a specific track	CHECK on the remote repeatedly until the number of the track to be cleared lights up, then press CLEAR.
Add a track to the program	1 Press DISC SKIP to select a CD. 2 Turn the jog dial to select a track. 3 Press PLAY MODE.
Clear the entire program	■ once in stop mode or twice while playing.

### Tips

- The program you created remains in the CD player's memory even after it has been played. Press ▷|| to play the same program again.
- If "--:--" appears instead of the total playing time while programming, this means:
  - you have programmed a track numbered over 20, or
  - the total playing time has exceeded 100 minutes.

## Playing CDs without interruption

### — Non-Stop Play

You can play CDs without pausing between tracks.

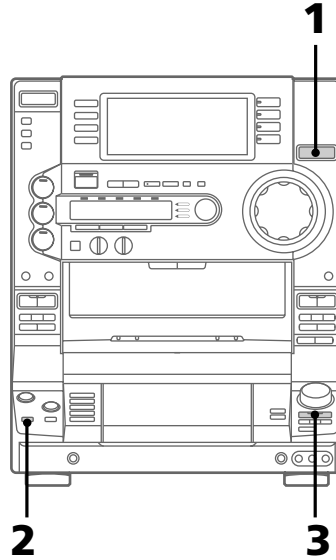

**1** Press FUNCTION repeatedly until "CD" appears in the display.

**2** Press NON-STOP so the indicator on this button lights up.

**3** Press ▷||.

### To cancel Non-Stop Play

Press NON-STOP so that the indicator on this button goes off.

## Recording on a tape manually

You can record from CDs, tapes, or the radio. For example, you can record just the desired songs or begin recording from the middle of a tape. The recording level is automatically adjusted.

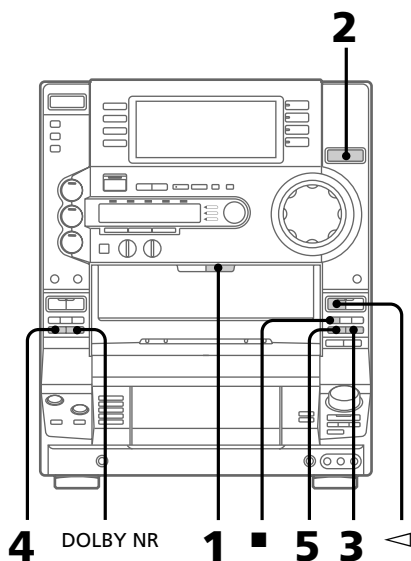

- 1** Press **B EJECT** and insert a recordable tape into deck B.
- 2** Press **FUNCTION** repeatedly until the source you want to record (e.g., CD) appears in the display.
- 3** Press **REC**.  
Deck B stands by for recording, and the indicator on the **DIRECTION** button (for the front side) lights up green.
- 4** Press **DIRECTION** repeatedly until **←** appears to record on one side or **↔** (or RELAY) to record on both sides.

- 5** Press **||**.  
Recording starts.
- 6** Start playing the source to be recorded.

To	Press
Stop recording	<b>■</b> on deck B
Pause recording	<b>  </b>

### Tips

- When you want to record on the reverse side, press **◀** after pressing **● REC** in step 3 so the indicator on the **◀** button (for the reverse side) lights up green.
- When you want to reduce the hiss noise in low-level, high-frequency signals, press **DOLBY NR** before step 5 so “DOLBY NR B” appears in the display.



# Recording CDs by specifying the track order

## — Program Edit

You can record tracks from all the CDs in the order you want. When programming, make sure the playing times for each side do not exceed the length of one side of the tape.

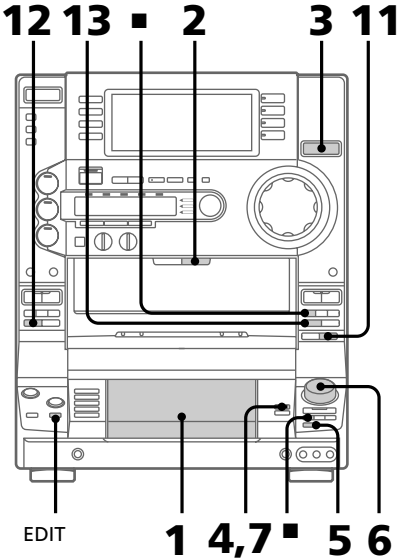

EDIT

1 4,7 5 6

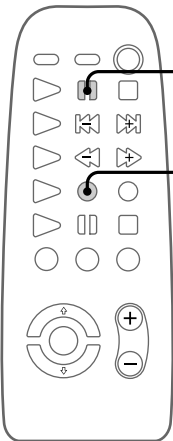

- 1 Place CDs and close the front cover.
- 2 Press **▲** B EJECT and insert a recordable tape into deck B.
- 3 Press FUNCTION repeatedly until "CD" appears in the display.
- 4 Press PLAY MODE repeatedly until "PROGRAM" appears in the display.
- 5 Press DISC SKIP to select a CD.
- 6 Turn the jog dial until the desired track appears in the display.

### Wide display

Disc number

Track number Total playing time

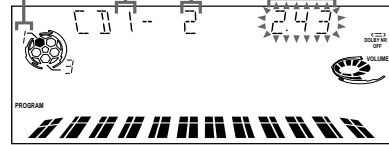

### Normal display

Disc number

Track number Total playing time

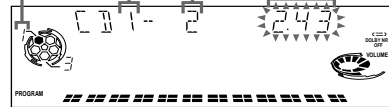

## Recording CDs by specifying the track order (continued)

- 7** Press PLAY MODE once.  
The track is programmed. First "STEP" and the programmed playing order appear, then the total playing time appears.

### Wide display

The last programmed track Total playing time

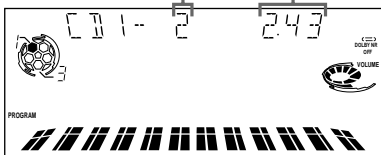

### Normal display

The last programmed track Total playing time

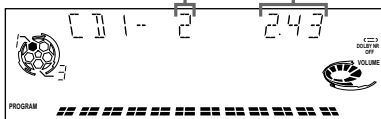

- 8** Repeat steps 5 through 7 to program additional tracks to be recorded on side A.  
Skip step 5 to select tracks from the same disc.

- 9** Press **II** on the remote to insert a pause at the end of side A.  
"P" appears in the display and the total playing time resets to "0.00" in the display.

- 10** Repeat steps 5 through 7 to program the tracks to be recorded on side B.  
Skip step 5 to select tracks from the same disc.

- 11** Press CD SYNC.

Deck B stands by for recording, the CD player stands by for playback, and the indicator on the  $\triangleright$  button (for the front side) lights up green.

- 12** Press DIRECTION repeatedly until  $\rightleftarrows$  appears to record on one side, or  $\rightleftarrows$  (or RELAY) to record on both sides.

- 13** Press **II**.  
Recording starts.

## To stop recording

Press **■** on deck B or on the CD player.

## To check the order

Press CHECK on the remote repeatedly. After the last track, "CHECK END" appears.

## To cancel Program Edit

Press PLAY MODE repeatedly until "PROGRAM," "ALL DISCS SHUFFLE," or "1 DISC SHUFFLE" disappears from the display.

## Selecting the tape length automatically

### — Tape Select Edit

You can check the most suitable tape length for recording a CD. Note that you cannot use Tape Select Edit for discs containing more than 20 tracks.

- ➔** After inserting a CD, press EDIT once so that "EDIT" flashes.  
First the required tape length for the CD in the playing position appears, then the total playing time for sides A and B appears.

### Note

You cannot use this function when Program Play mode has been set. After clearing the entire program, follow the above procedure (see "Clear the entire program" in the table on page 23).

## Looping part of a CD

### — Loop

With the Loop function, you can repeat part of a CD during playback. This lets you create original recordings.

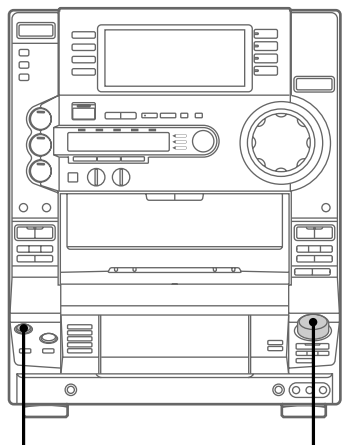

LOOP

Jog dial

➔ Press and hold LOOP during playback at the point you want to start the Loop function, and release to resume normal playback.

### To adjust the loop length

Turn the jog dial while holding LOOP (or press FILE SELECT ▲/▼ while holding LOOP on the remote) to select different loop lengths.

## Flashing part of a CD

### — Flash

With the Flash function, you can “flash” the CD sound during playback. This lets you create original recordings.

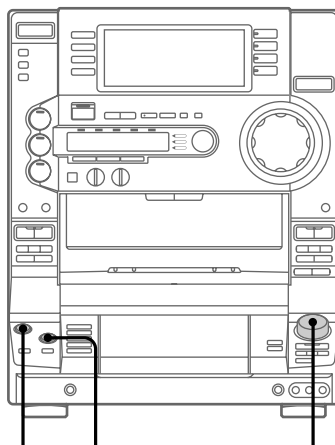

LOOP

FLASH

Jog dial

➔ Press and hold FLASH during playback at the point you want to start the Flash function, and release to resume normal playback.

### To adjust the flash length

Turn the jog dial while holding FLASH (or press FILE SELECT ▲/▼ while holding FLASH on the remote) to select different flash lengths.

### To use LOOP and FLASH together

Press and hold both LOOP and FLASH at the same time.

### Note

The loop and flash length cannot be adjusted in stop mode. Adjust the loop and flash lengths during playback.

## Adjusting the sound

You can create a more powerful sound and listen with headphones.

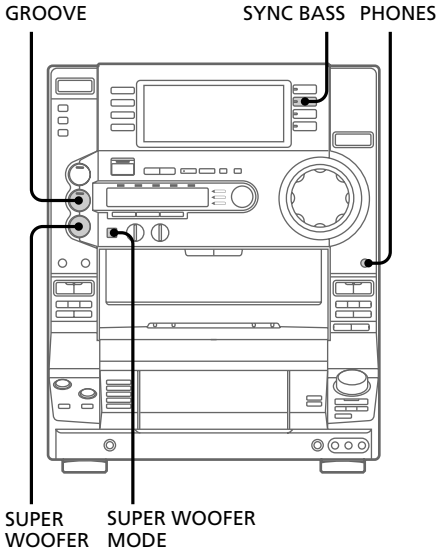

### To reinforce the bass from the super woofer (SUPER WOOFER)

Press SUPER WOOFER.

Each time you press this button, the super woofer level display changes as follows:

SUPER WOOFER FLAT → LOW → HIGH

### To select the super woofer mode

Press SUPER WOOFER MODE while the super woofer is on.

Each time you press this button, the super woofer mode display changes as follows:

MODE MOVIE ↔ MODE MUSIC

### For a powerful sound (GROOVE)

Press GROOVE.

The volume switches to power mode, the equalizer curve changes, the super woofer level changes to "HIGH," and the indicator on the GROOVE button lights up. Press GROOVE again to return to the previous volume.

#### Note

Canceling the Groove mode cancels the equalizer curve and super woofer level. Adjust the equalizer settings to obtain the desired effect.

### For the most suitable bass sound (SYNC BASS)

Press SYNC BASS.

The bass frequencies of the music you are listening to are measured and those areas with heavy bass tones are effectively reinforced. The indicator on the SYNC BASS button flashes while measuring. Once measured, the indicator stops flashing and remains lit. Press SYNC BASS again to return to the previous level.

#### Notes

- The super woofer mode changes to MODE MUSIC in the SYNC BASS (Synchronized Bass) mode.
- If you press SUPER WOOFER MODE in the SYNC BASS mode, this mode is canceled and the super woofer mode changes to MODE MOVIE.
- You can change the super woofer level to LOW or HIGH in the SYNC BASS mode. However, if you change the level to SUPER WOOFER FLAT, the SYNC BASS mode is canceled.

### To listen through the headphones

Connect the headphones to the PHONES jack.

No sound will come from the speakers.

# Selecting the audio emphasis

The audio emphasis menu lets you select the sound characteristics according to the music you are listening to.

And you can also enjoy the audio emphasis using the Synchronized Equalizer function. When using this function, the system automatically switches the equalizer according to the genre of the music.

The Personal File function (see “Making a personal audio emphasis file (Personal File)” on page 32) lets you store your own effects.

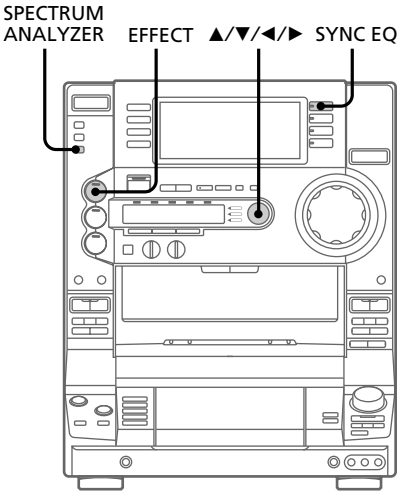

➔ Press ▲/▼ to select MENU 1 or MENU 2, then press ◀/▶ to select the desired audio emphasis.

See the chart “Music menu options” on this page. The audio emphasis name appears in the display.

When using the remote, press FILE SELECT ▲/▼ repeatedly until the desired audio emphasis name appears.

## To cancel the audio emphasis

Press EFFECT (or FILE SELECT ON/OFF on the remote) repeatedly so that the indicator on the EFFECT button goes off.

## Music menu options

“SUR(|||||)” appears if you select an audio emphasis with a surround effect.

Press	To select	
▲/▼	MENU 1	MENU 2
◀/▶	ROCK	MOVIE
	POP	GAME
	JAZZ	NIGHT
	DANCE	PARTY
	SALSA	RELAX

## Using the Synchronized Equalizer function

You can set the audio emphasis to change automatically according to the beat and tempo of the music.

➔ Press SYNC EQ.

The indicator on the SYNC EQ button flashes while measuring the beat and tempo of the source. Once measured, the indicator stops flashing and remains lit.

SYNC EQ classifies the music source as follows:

Beat Density	LO (Low) HI (High)
Beat Strength	SMOOTH MEDIUM STRONG

## Selecting the audio emphasis (continued)

### To cancel the Synchronized Equalizer function

Press SYNC EQ again so that the indicator goes off.

The Synchronized Equalizer function is canceled also when:

- you cancel the audio emphasis
- you reselect the audio emphasis from the music menu
- you activate the surround effect
- you adjust the graphic equalizer
- you sing along (KARAOKE)

### Notes

- The Synchronized Equalizer function does not work in KARAOKE mode.
- P FILE MEMORY does not work in this mode.
- The classification is not related to the genre of the music source.

## Changing the equalizer display

You can change the equalizer display according to the music you are listening to.

- 
- ➔ Press SPECTRUM ANALYZER.  
Every time you press this button, the display changes as follows:  
IMAGE PATTERN ↔ NORMAL PATTERN
- 

### To cancel the display pattern

Press SPECTRUM ANALYZER again. The display changes to show the equalizer curve.

---

## Adjusting the audio emphasis

You can adjust the audio emphasis using the graphic equalizer and surround effect.

### Adjusting the graphic equalizer

You can adjust the sound by raising or lowering the levels of specific frequency ranges.

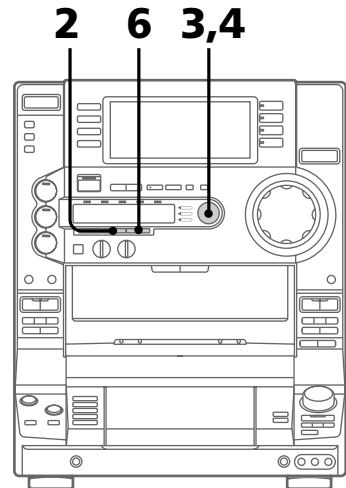

- 
- 1** Select the desired basic audio emphasis for your sound (see “Selecting the audio emphasis” on page 29).
- 

- 2** Press GEQ CTRL.  
The frequency range appears and the level value flashes in the display.

- 
- 3** Press ◀/▶ repeatedly to select a frequency band.

**Wide display**

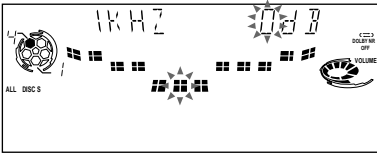

**Normal display**

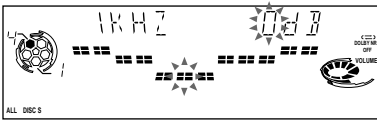

- 
- 4** Press ▲/▼ to adjust the level.

**Wide display**

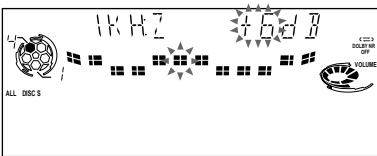

**Normal display**

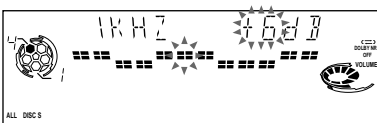

- 
- 5** Repeat steps 3 and 4 to adjust the other frequency bands.

- 
- 6** Press ENTER when finished.
- 

**Note**

If you choose another audio emphasis (other than "EFFECT OFF"), the adjusted sound effect is lost. To retain the adjusted sound effect for future use, store it in a personal file (see "Making a personal audio emphasis file" on page 32).

## Activating the surround effect

You can enjoy the surround effect.

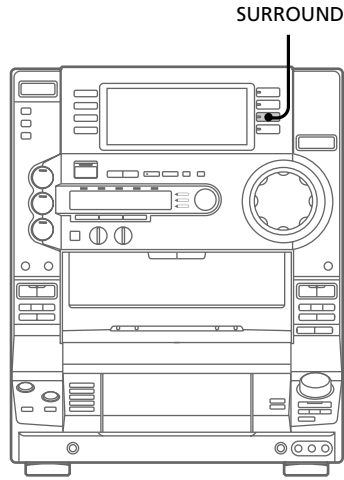

- 
- ➔ Press SURROUND so that "SUR(|||||)" appears in the display and the SURROUND button lights up.

Every time you press this button, the display changes as follows:  
SURROUND ON ↔ SURROUND OFF

---

**Note**

If you choose other sound effects, the surround effect will be canceled. To retain the effect, store it in a personal file (see "Making a personal audio emphasis file" on page 32).

# Making a personal audio emphasis file

## — Personal File

You can create personal files of audio patterns (surround effect and graphic equalizer) and store them in the system's memory. Later, you can call up an audio pattern when playing a favorite tape, CD, or radio program. You can create up to five audio files. Before operation, first select the basic audio emphasis you want for your sound.

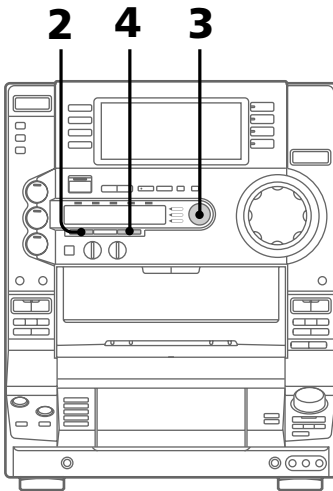

- 1** Create the desired sound effect by using the graphic equalizer and/or surround effect (see "Adjusting the audio emphasis" on page 30).

- 2** Press P FILE MEMORY.  
A personal file number appears in the display.

### Wide display

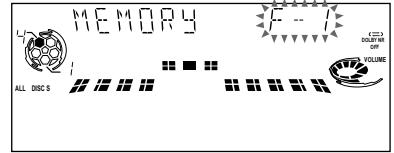

### Normal display

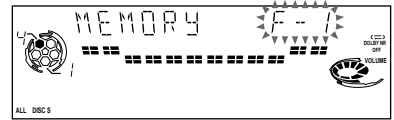

- 3** Press ◀/▶ to select the file number (P FILE) where you want to store the sound effect.

- 4** Press ENTER.  
The adjusted sound effects are stored under the selected file number. Any settings previously stored at this memory location are erased and replaced by the new settings.

### To call up the personal file

Press ▲/▼ repeatedly to display the last selected personal file, then press ◀/▶ repeatedly to select the desired personal file. When using the remote, press FILE SELECT ▲/▼ repeatedly.



# Using the Radio Data System (RDS) (For European models only)

## What is the Radio Data System?

The Radio Data System (RDS) is a broadcasting service that allows radio stations to send additional information along with the regular program signal. This tuner offers convenient RDS feature, such as monitoring traffic, news, information programs, and locating a station by program type. RDS is available only on FM stations.\*

### Note

RDS may not work properly if the station you are tuned to is not transmitting the RDS signal properly or if the signal strength is weak.

\* Not all FM stations provide RDS service, nor do they all provide the same types of services. If you are not familiar with the RDS system, check with your local radio stations for details on RDS services in your area.

## Receiving RDS broadcasts

➔ Select a station from the FM band. When you tune in a station that provides RDS services, the station name appears in the display.

### To check the RDS information

Each time you press DISPLAY, the display changes as follows:

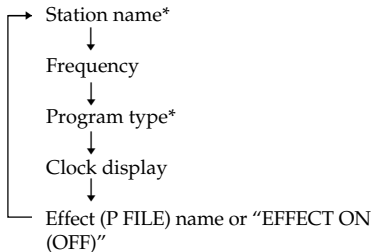

\* If an RDS broadcast is not received, the station name and the program type may not appear in the display.

## Locating a station by program type (PTY)

You can locate the desired station by selecting a program type. The system tunes in that type of program currently being broadcast from the RDS stations stored in the tuner's preset memory.

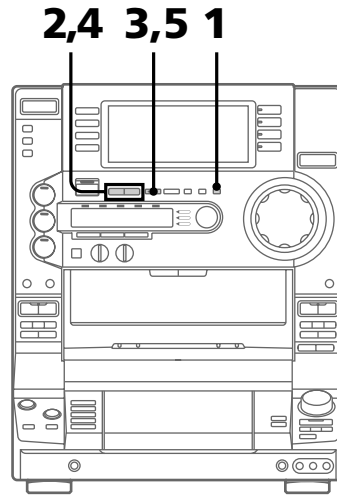

- 1** Press PTY while listening to the radio.
- 2** Press TUNING +/- to select the desired program type. See the "List of program types (PTY)" on the following page.
- 3** Press ENTER/NEXT.  
The system starts searching for the preset RDS stations ("SEARCH" and the selected program type appear alternately in the display).  
When the tuner receives a program, the preset station number flashes.

## **Using the Radio Data System (RDS) (continued)**

---

**4** Press TUNING +/- until the desired preset station number flashes in the display.

---

**5** Press ENTER/NEXT while the preset station number is flashing.

---

### **To stop the search while it is in progress**

Press PTY.

### **List of program types (PTY)**

---

#### **NONE**

No program type or undefined.

---

#### **NEWS**

News programs.

---

#### **AFFAIRS**

Topical programs that expand on current news.

---

#### **INFORMATION**

Programs about consumer affairs and medical advice.

---

#### **SPORT**

Sports programs.

---

#### **EDUCATION**

Educational programs, such as "how-to" programs and advice.

---

#### **DRAMA**

Radio plays and serials.

---

#### **CULTURE**

Programs about national or regional culture, language, and social concerns.

---

#### **SCIENCE**

Programs about the natural sciences

---

#### **VARIED**

Programs containing celebrity interviews, panel games, and comedy.

---

#### **POP**

Popular music programs.

---

#### **ROCK**

Rock music programs.

---

---

#### **EASY MUSIC**

Easy listening (middle of the road music).

---

#### **L.CLASSICAL**

Classical music, such as instrumental, vocal, and choral works.

---

#### **S.CLASSICAL**

Performances of major orchestras, chamber music, opera, etc.

---

#### **OTHER MUSIC**

Music, such as rhythm and blues and reggae.

---

#### **WEATHER**

Weather information.

---

#### **FINANCE**

Stock market reports and trading, etc.

---

#### **CHILDREN**

Programs for the young.

---

#### **SOCIAL**

Programs about people and the things that affect them.

---

#### **RELIGION**

Programs of religious content.

---

#### **PHONE IN**

Programs where members of the public express their views by phone or in a public forum.

---

#### **TRAVEL**

Programs about travel. Not for announcements that are located by TP/TA.

---

#### **LEISURE**

Programs on recreational activities such as gardening, fishing, cooking, etc.

---

#### **JAZZ**

Jazz programs.

---

#### **COUNTRY**

Country music programs.

---

#### **NATION**

Programs featuring the popular music of the country or region.

---

#### **OLDIES**

Programs featuring oldies music.

---

#### **FOLK**

Folk music programs.

---

---

**DOCUMENTARY**

Investigative features.

---

**ALARM TEST**

Test signal for emergency broadcasts.

---

**ALARM-ALARM**

Emergency broadcasts.

---

**Note**

“NO PTY” appears when the program you selected is not currently being broadcasted.

---

# Singing along: Karaoke

You can sing along with any stereo CD or tape by turning down the singer’s voice. You need to connect an optional microphone.

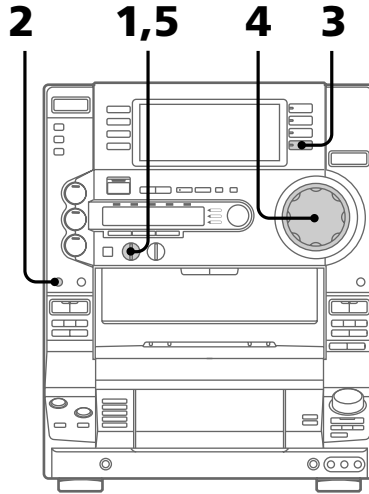

- 
- 1** Turn MIC LEVEL to MIN to turn down the microphone level.

---

  - 2** Connect an optional microphone to the MIX MIC.

## Singing along: Karaoke (continued)

- 
- 3** Press MIX GUITAR/KARAOKE repeatedly to obtain the karaoke effect.

Each time you press this button, the display changes as follows:

MIX GUITAR/KARAOKE



OFF or audio emphasis name

“🎸” appears in the display and reduce the singer’s voice on a CD or tape when the karaoke mode is activated.

- 
- 4** Start playing the music and adjust the volume.

- 
- 5** Turn MIC LEVEL to adjust the microphone volume.
- 

### When you are done

Turn MIC LEVEL to MIN and disconnect the microphone from MIX MIC, then press MIX GUITAR/KARAOKE repeatedly until “🎸” disappears from the display.

### Note

With some songs, vocals may not be canceled when you select MIX GUITAR/KARAOKE.

## Mixing and recording sounds

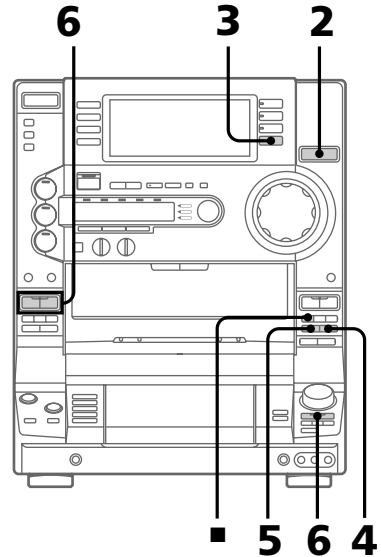

- 
- 1** Prepare the microphone. Then, insert a recordable tape in deck B.
- 
- 2** Press FUNCTION repeatedly to select the source you desire and set it to pause mode.
- 
- 3** Press MIX GUITAR/KARAOKE to activate the karaoke mode.
- 
- 4** Press ● REC.
- 
- 5** Press II.
- 
- 6** Press ▷ II to start playing the CD (or ▷ on deck A to start playing the tape).  
Playback starts.  
Start singing along with the music.
-



# Waking up to music

## — Daily Timer

You can wake up to music at a preset time every day. Make sure you have set the clock (see “Step 3: Setting the time” on page 7).

The 24-hour system model is used for illustration purposes.

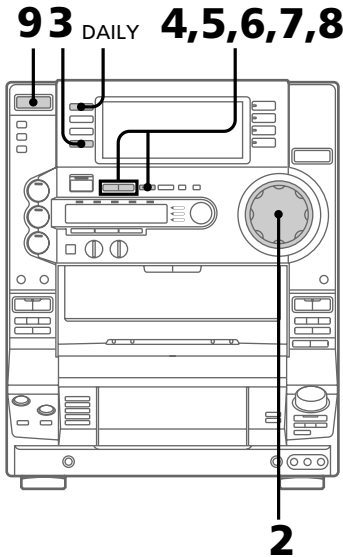

### 1 Prepare the music source you want to play.

- CD: Insert a CD. To start from a specific track, create a program (see “Programming CD tracks” on page 21).
- Tape: Insert a tape with the side you want to play facing forward.
- Radio: Tune in a preset station (see “Step 4: Presetting radio stations” on page 8).

### 2 Turn VOLUME to adjust the volume.

### 3 Press $\odot$ /CLOCK SET. “SET” appears and “DAILY” flashes in the display.

### 4 Press TUNING +/- to select “DAILY,” then press ENTER/NEXT. “ON” appears and the hour indication flashes in the display.

#### Wide display

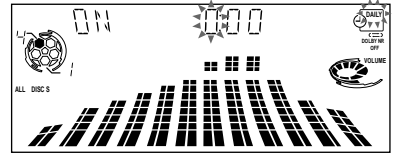

#### Normal display

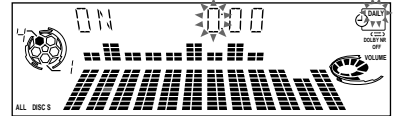

### 5 Set the time to start playback. Press TUNING +/- to set the hour, then press ENTER/NEXT. The minute indication flashes.

#### Wide display

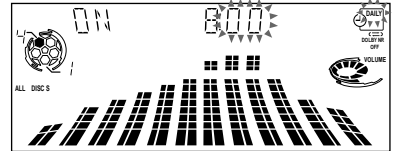

#### Normal display



Press TUNING +/- to set the minutes, then press ENTER/NEXT.  
The hour indication flashes again.

### 6 Set the time to stop playback following the above procedure.

- 
- 7** Press TUNING +/- until the desired music source appears.

The indication changes as follows:  
TUNER → CD PLAY → TAPE PLAY



- 
- 8** Press ENTER/NEXT.

The start time, the stop time, and the music source appear in turn before the original display returns.

- 
- 9** Turn off the system.
- 

### To check the setting

- 1** Press DAILY.

"TIMER OFF" appears in the display.

- 2** Press DAILY again.

To change the setting, start over from step 1 on the previous page.

### To cancel the timer operation

Press DAILY.

"TIMER OFF" appears in the display.

### Notes

- The system turns on 15 seconds before the preset time.
- You cannot set the timer if the timer on and off times are the same.
- When you set the Sleep Timer, the Daily Timer will not turn on the system until the Sleep Timer turns it off.
- You cannot set the Daily Timer and Timer-recording to be activated at the same time.

---

## Timer-recording radio programs

To timer-record, you must preset the radio station (see "Step 4: Presetting radio stations" on page 8) and set the clock (see "Step 3: Setting the time" on page 7) beforehand.

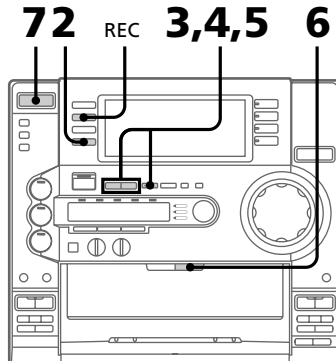

- 
- 1** Tune in the preset radio station (see "Listening to the radio" on page 13).

- 
- 2** Press ⊖/CLOCK SET.

"SET" appears and "DAILY" flashes in the display.

- 
- 3** Press TUNING +/- to select "REC," then press ENTER/NEXT.

"ON" appears and the hour indication flashes in the display.

### Wide display

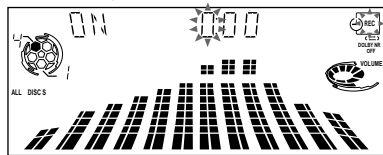

### Normal display

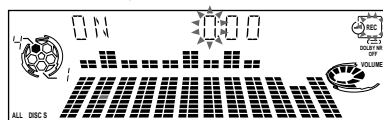

## Timer-recording radio programs (continued)

### 4 Set the time to start recording.

Press TUNING +/- to set the hour, then press ENTER/NEXT.

The minutes indication flashes.

#### Wide display

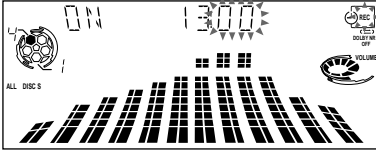

#### Normal display

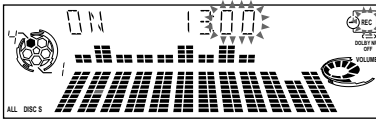

Press TUNING +/- to set the minutes, then press ENTER/NEXT.

The hour indication flashes again.

### 5 Set the time to stop recording following the above procedure.

The start time, the stop time, the recording source, and the preset station appear in turn before the original display returns.

### 6 Press **▲** B EJECT and insert a recordable tape in deck B.

### 7 Turn off the system.

When recording starts, the volume level is set to minimum.

## To cancel the timer operation

Press REC.

"TIMER OFF" appears in the display.

### Notes

- The system turns on 15 seconds before the preset time.
- If the system is on at the preset time, the Timer recording will not be made.
- You cannot set the timer on and off times are the same.
- When you set the Sleep Timer, the Timer-recording will not start until the Sleep Timer turns off the system.
- You cannot set the Daily Timer and Timer-recording to be activated at the same time.
- Recording starts from the front side.

## To check the setting

1 Press REC.

"TIMER OFF" appears in the display.

2 Press REC again.

To change the setting, start over from step 1 on the previous page.



## Connecting audio components

### Connecting a turntable

Be sure to match the color of the plugs and the connectors. To listen to the sound from the connected turntable, press FUNCTION repeatedly until "PHONO" appears. Refer to the instructions included with your turntable for details.

To the audio outputs of the turntable

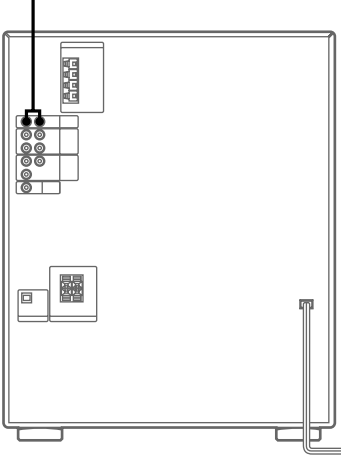

#### Note

Using the turntable at high volume may cause distortion or howling. This is often caused by the bass sound from the speakers. The bass sound may be picked up by the needle of the turntable, and produce the distortion or howling. To avoid this, do the following:

- 1 Keep some distance between the speakers and the turntable.
- 2 Stop using the surround effect.
- 3 Install the speakers or the turntable on a firm and stable surface.
- 4 Press SUPER WOOFER repeatedly until the indicator on this button goes off.

### Connecting an MD deck for digital recording

You can record a CD to an MD digitally by connecting your MD deck using an optical cable. Refer to the instructions included with your MD deck for details.

To the digital input of the MD deck

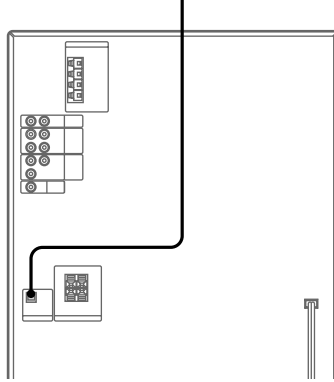

### Connecting an MD deck for analog recording

Be sure to match the color of the plugs and the connectors. To listen to the sound of the connected MD deck, press FUNCTION repeatedly until "MD" appears. Refer to the instructions included with your MD deck for details.

To the audio outputs of the MD deck      To the audio inputs of the MD deck

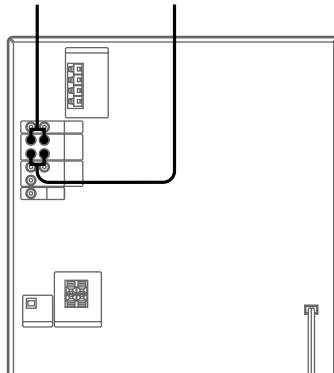

## Connecting audio components (continued)

### Connecting a mixer (for European, North American, and Mexican models only)

You can connect a mixer to the DJ MIX jacks on the rear panel of the unit.

To the outputs  
of the mixer

To the inputs  
of the mixer

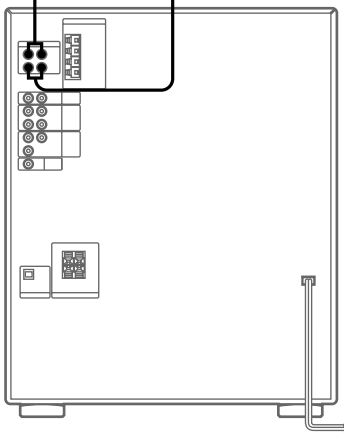

- 1 Remove the jumpers from the unit.
- 2 Connect the SEND jack of the unit to the IN jack of the mixer with an optional cable.
- 3 Connect the OUT jack of the mixer to the RETURN jack of the unit with an optional cable.
- 4 Press FUNCTION repeatedly until "CD" appears.

You can also record the sound produced by the mixer onto a tape.

#### Note

Replace the jumpers when the mixer is not in use. Otherwise, no sound will come from the unit. Be sure to connect the jumpers from the RETURN jack to the SEND jack of the unit.

Two jumpers are preinstalled connecting the DJ MIX RETURN and SEND jacks.

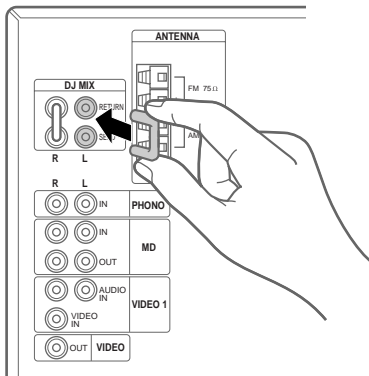

### Connecting surround speakers (LBT-LX50 only)

You can connect optional surround speakers. Refer to the instructions included with your surround speakers for details.

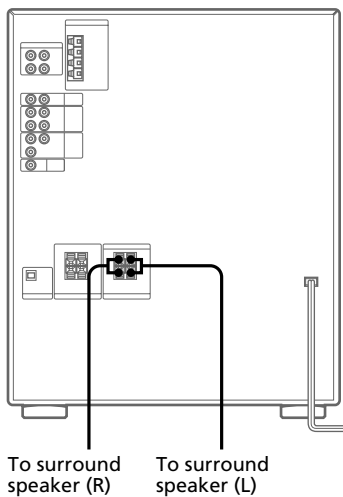

#### Note

You need to connect both left and right surround speakers. Otherwise, the sound will not be heard.

## Connecting a guitar

You can connect an electric guitar to the GUITAR jack on the front panel.

When you select "MIX GUITAR/KARAOKE" by pressing MIX GUITAR/KARAOKE, you can play along with any stereo CD or tape.

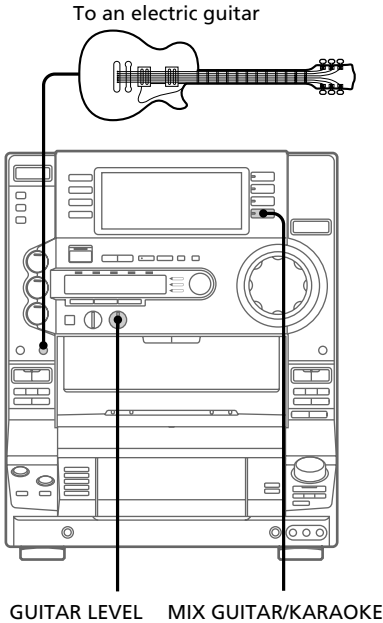

You can select your preferred sound characteristics by adjusting the GUITAR LEVEL.

## Connecting video components

You can connect a VCR, camcorder, or video game to the VIDEO 1 jack on the rear panel and/or the VIDEO2 INPUT jack on the front panel. To see the picture from the connected components, connect the input jack of your TV to the VIDEO OUT jack with the video connecting cable (not supplied).

### Connecting a VCR

Be sure to match the color of the plugs and the connectors. To listen to the sound from the connected VCR, press FUNCTION repeatedly until "VIDEO 1" appears.

Refer to the instructions included with your VCR for details.

To the audio outputs of the VCR      To the video output of the VCR

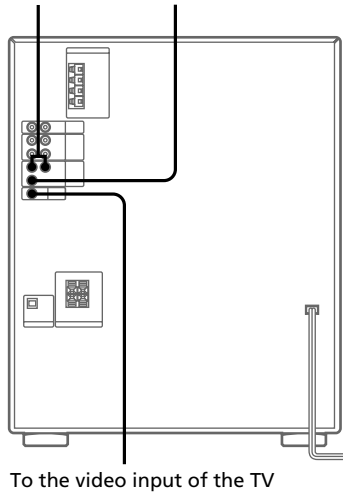

## Connecting video components (continued)

### Connecting a camcorder or video game

Be sure to match the color of the plugs and the connectors. To listen to the sound from the connected camcorder or video game, press FUNCTION repeatedly until "VIDEO 2" appears.

Refer to the instructions included with each component for details.

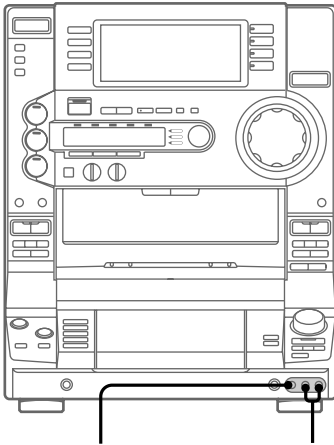

To the video  
output of the  
component

To the audio  
outputs of the  
component

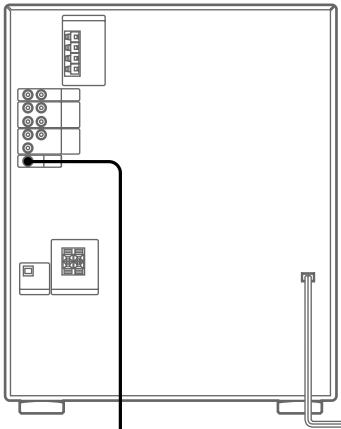

To the video input of the TV

## Connecting outdoor antennas

Connect an outdoor antenna to improve the reception. Refer to the instructions of each component.

### FM antenna

Connect an optional FM outdoor antenna. You can also use the TV antenna instead.

#### Jack type ①

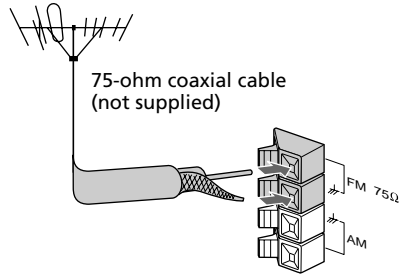

#### Jack type ②

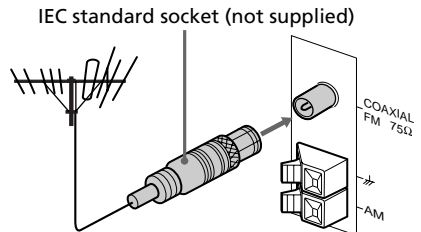

## AM antenna

Connect a 6 to 15 meter (20 to 50 feet) insulated wire to the AM antenna terminal. Leave the supplied AM loop antenna connected.

### Jack type ①

Insulated wire (not supplied)

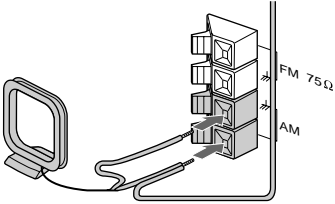

### Jack type ②

Insulated wire (not supplied)

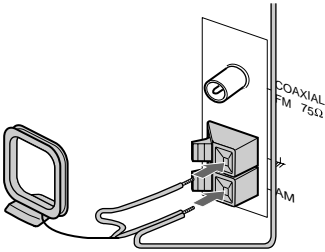

## Important

If you connect an outdoor antenna, connect a ground wire to the  $\hbar$  terminal with the screw clamp. To prevent a gas explosion, do not connect the ground wire to a gas pipe.

## Precautions

### On operating voltage

Before operating the system, check that the operating voltage of your system is identical with the voltage of your local power supply.

### On safety

- The unit is not disconnected from the AC power source (mains) as long as it is connected to the wall outlet, even if the unit itself has been turned off.
- Unplug the system from the wall outlet (mains) if it is not to be used for an extended period of time. To disconnect the cord (mains lead), pull it out by the plug. Never pull the cord itself.
- Should any solid object or liquid fall into the component, unplug the stereo system and have the component checked by qualified personnel before operating it any further.
- The AC power cord must be changed only at a qualified service shop.

### On placement

- Place the stereo system in a location with adequate ventilation to prevent heat build-up in the stereo system.
- Do not place the system in an inclined position.
- Do not place the system in locations where it is;
  - Extremely hot or cold
  - Dusty or dirty
  - Very humid
  - Subject to vibrations
  - Subject to direct sunlight

### On operation

- If the stereo system is brought directly from a cold to a warm location, or is placed in a very damp room, moisture may condense on the lens inside the CD player. Should this occur, the system will not operate properly. Remove the CD and leave the system turned on for about an hour until the moisture evaporates.
- When you move the system, take out any discs.

If you have any questions or problems concerning your stereo system, please consult your nearest Sony dealer.

## Precautions (continued)

### Notes on CDs

- Before playing, clean the CD with a cleaning cloth. Wipe the CD from the center out.
- Do not use solvents such as benzene, thinner, commercially available cleaners, or anti-static spray intended for vinyl LPs.
- Do not expose the CD to direct sunlight or heat sources such as hot air ducts, nor leave it in a car parked in direct sunlight.

### Cleaning the cabinet

Use a soft cloth slightly moistened with mild detergent solution.

### To save a tape permanently

To prevent a tape from being accidentally recorded over, break off the cassette tab from side A or B as illustrated.

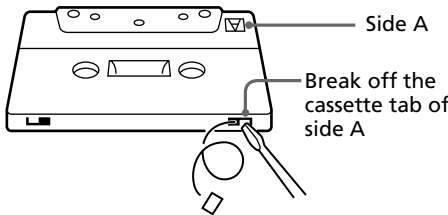
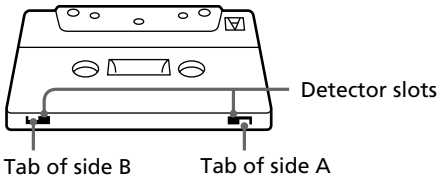

If you later want to reuse the tape for recording, cover the broken tab with adhesive tape. However, be careful not to cover the detector slots which allow the tape player to automatically detect the type of tape.

Tape type: CrO<sub>2</sub>/Metal

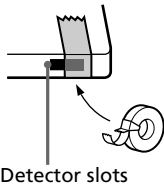

Normal

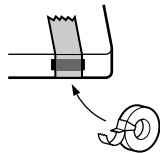

### Before placing a cassette in the tape deck

Take up any slack in the tape. Otherwise the tape may get entangled inside the tape deck and become damaged.

### When using a tape longer than 90 minutes

The tape is very elastic. Do not frequently change the tape operations such as play, stop, and fast-forwarding, etc. The tape may get entangled in the tape deck.

### Cleaning the tape heads

Clean the tape heads after every 10 hours of use.

When the tape heads become dirty

- the sound is distorted
- there is a decrease in sound level
- the sound drops out
- the tape does not erase completely
- the tape does not record

Make sure to clean the tape heads before you start an important recording or after playing an old tape. Use a separately sold dry-type or wet-type cleaning cassette. For details, refer to the instructions of the cleaning cassette.

### Demagnetizing the tape heads

Demagnetize the tape heads and the metal parts that have contact with the tape every 20 to 30 hours of use with a separately sold demagnetizing cassette. For details, refer to the instructions of the demagnetizing cassette.

---

# Troubleshooting

If you run into any problem using this stereo system, use the following checklist.

First, check that the power cord is connected firmly and that the speakers are connected correctly and firmly.

Should any problem persist, consult your nearest Sony dealer.

---

## General

---

**The display starts flashing as soon as you plug in the power cord even though you haven't turned on the system (demonstration mode).**

- Press DISPLAY (for LBT-LX50/LX30/LX7/LX5) or DEMO (STAND BY) (for other models) while the system is off.

If the system is in the Power Saving mode, press POWER SAVE/DEMO (STAND BY) (for LBT-LX50/LX30/LX7/LX5).

The demonstration appears automatically the first time you plug in the power cord, or if there is a power outage lasting longer than half a day.

---

**The clock setting/radio presetting is canceled.**

- The power cord is disconnected or a power failure occurs for more than half a day.

Redo the following procedures:

- “Step 3: Setting the time” on page 7.
- “Step 4: Presetting radio stations” on page 8.

To set the timer function again, also redo “Waking up to music” on page 38 and “Timer-recording radio programs” on page 39.

---

**There is no sound.**

- The jumpers for the DJ MIX jacks are not connected (for European, North American, and Mexican models only).
- Turn VOLUME clockwise.
- The headphones are connected.
- Insert only the stripped portion of the speaker cord into the SPEAKER jack. Inserting the vinyl portion of the speaker cord will interfere with the speaker connection.

- The volume level is automatically set to the minimum during the Timer-recording.

---

**There is no microphone sound.**

- Turn VOLUME or MIC LEVEL to adjust the microphone volume.
- Make sure the microphone is connected to the MIX MIC jack correctly.

---

**There is no guitar sound.**

- Turn VOLUME or GUITAR LEVEL to adjust the guitar volume.
- Make sure the guitar is connected to the GUITAR jack correctly.
- Select “MIX GUITAR/KARAOKE” by pressing MIX GUITAR/KARAOKE.

---

**There is severe hum or noise.**

- A TV or VCR is placed too close to the stereo system. Move the stereo system away from the TV or VCR.

---

**“0:00” (for European models) or “12:00AM” (for other models) flashes in the display.**

- A power interruption occurred. Reset the clock and timer settings.

---

**The timer does not function.**

- Set the clock correctly.

---

**DAILY and REC do not appear when you press ☺/CLOCK SET.**

- Set the timer correctly.
- Set the clock.

---

**The remote does not function.**

- There is an obstacle between the remote and the system.
- The remote is not pointing in the direction of the system's sensor.
- The batteries have run down. Replace the batteries.

---

**There is acoustic feedback.**

- Decrease the volume level.
- Move the microphone away from the speakers or change the direction of the microphone.

---

**The color irregularity on a TV screen persists.**

- Turn off the TV set once, then turn it on after 15 to 30 minutes. If the color irregularity still persists, place the speakers farther away from the TV set.

---

continued

## **Troubleshooting (continued)**

### **Speakers**

**There is no sound and "PUSH POWER" and "PROTECT" appear in the display alternately.**

- Press I/⏻ to turn off the system and check the speaker connections and placement.

**Sound comes from only one channel or the left and right volumes are unbalanced.**

- Check the speaker connections and placement.

**There is no sound from the surround speakers (LBT-LX50 only).**

- Press SURROUND to turn on the surround effect.

### **CD Player**

**The CD tray does not rotate.**

- A CD is not placed properly.

**A CD will not play.**

- The CD is not lying flat in the disc tray.
- The CD is dirty.
- The CD is inserted label side down.
- Moisture condensation has built up. Remove the CD and leave the system turned on for about an hour until the moisture evaporates.

**Play does not start from the first track.**

- The player is in Program or Shuffle Play mode. Press PLAY MODE repeatedly until "PROGRAM," "ALL DISCS SHUFFLE," or "1 DISC SHUFFLE" disappears from the display.

### **Tape Deck**

**The tape does not record.**

- No tape is in the cassette holder.
- The tab has been removed from the cassette (see page 46).
- The tape has reeled to the end.

**The tape does not record nor play, or there is a decrease in sound level.**

- The heads are dirty. Clean them (see page 46).
- The record/playback heads are magnetized. Demagnetize them (see page 46).

**The tape does not erase completely.**

- The record/playback heads are magnetized. Demagnetize them (see page 46).

**There is excessive wow or flutter, or the sound drops out.**

- The capstans or pinch rollers are dirty. Clean them (see page 46).

**Noise increases or the high frequencies are missing.**

- The record/playback heads are magnetized. Demagnetize them (see page 46).

### **Tuner**

**Severe hum or noise ("TUNED" or "STEREO" flashes in the display).**

- Adjust the antenna.
- The signal strength is too weak. Connect an external antenna.

**A stereo FM program cannot be received in stereo.**

- Press STEREO/MONO so "STEREO" appears in the display.

**If other problems not described above occur, reset the system as follows:**

- 1 Unplug the power cord.
- 2 Plug the power cord back in.
- 3 Press ⏻/CLOCK SET, ENTER, and I/⏻ at the same time.

The system is reset to the factory settings. All the settings you made, such as the preset stations, clock, and timer are cleared. You should set them again.



# Specifications

## For the U.S. model

### AUDIO POWER SPECIFICATIONS

#### POWER OUTPUT AND TOTAL HARMONIC DISTORTION:

With 6 ohm loads, both channels driven, from 120 - 10,000 Hz; rated 140 watts per channel minimum RMS power, with no more than 10% total harmonic distortion.

#### Amplifier section

(LBT-LX50 (Canadian model only))

Continuous RMS power output (Reference)  
160 + 160 watts  
(6 ohms at 1 kHz, 10 % THD)

Total harmonics distortion  
Less than 0.07 %  
(6 ohms at 1 kHz, 70 w)

(LBT-LX8)

The following measured at AC 120/220/240 V, 50 Hz

DIN power output (Rated)  
240 + 240 watts  
(4 ohms at 1 kHz, DIN)  
Continuous RMS power output (Reference)  
300 + 300 watts  
(4 ohms at 1 kHz, 10 % THD)

(LBT-LX6)

The following measured at AC 120/220/240 V, 50 Hz

DIN power output (Rated)  
150 + 150 watts  
(6 ohms at 1 kHz, DIN)  
Continuous RMS power output (Reference)  
200 + 200 watts  
(6 ohms at 1 kHz, 10 % THD)

(LBT-LX7)

DIN power output (Rated)  
200 + 200 watts  
(6 ohms at 1 kHz, DIN)  
Continuous RMS power output (Reference)  
250 + 250 watts  
(6 ohms at 1 kHz, 10 % THD)

Music power output (Reference)  
430 + 430 watts  
(6 ohms at 1kHz, 10 % THD)

(LBT-LX5)

DIN power output (Rated)  
110 + 110 watts  
(6 ohms at 1kHz, DIN)  
Continuous RMS power output (Reference)  
140 + 140 watts  
(6 ohms at 1kHz, 10 % THD)  
Music power output (Reference)  
240 + 240 watts  
(6 ohms at 1 kHz, 10 % THD)

#### Inputs

DJ MIX IN \*(phono jacks): sensitivity 250 mV, impedance 47 kilohms  
GUITAR IN (phone jack): sensitivity 75 mV, impedance 470 kilohms  
PHONO IN (phono jacks): sensitivity 3 mV, impedance 47 kilohms  
MIX MIC (phono jack): sensitivity 1 mV, impedance 10 kilohms  
VIDEO 1 IN (phono jacks): sensitivity 250 mV, impedance 47 kilohms  
VIDEO 2 IN (phono jacks): sensitivity 250 mV, impedance 47 kilohms  
MD IN (phono jacks): sensitivity 450 mV, impedance 47 kilohms

#### Outputs

DJ MIX OUT \*(phono jacks): sensitivity 250 mV, impedance 1 kilohms  
PHONES (stereo phone jack): accepts headphones of 8 ohms or more  
VIDEO OUT (phono jack): voltage 250 mV, impedance 1 kilohm  
MD OUT (phono jacks): voltage 250 mV, impedance 1 kilohm

#### FRONT SPEAKER :

(LBT-LX8) accepts impedance of 4 to 16 ohms  
(LBT-LX7/LX6/LX5/LX50/LX30) accepts impedance of 6 to 16 ohms

#### SURROUND SPEAKER (LBT-LX50 only) :

accepts impedance of 16 ohms

\* European, North American, and Mexican models only.

## Specifications (continued)

### CD player section

System	Compact disc and digital audio system
Laser	Semiconductor laser ( $\lambda = 780$ nm), Emission duration : continuous
Laser output	Max. 44.6 $\mu$ W* * This output is the value measured at a distance of 200 mm from the objective lens surface on the Optical Pick-up Block with 7 mm aperture.
Wavelength	780 - 790 nm
Frequency Response	2 Hz - 20 kHz ( $\pm 0.5$ dB)
Signal-to-noise ratio	More than 90 dB
Dynamic range	More than 90 dB
CD DIGITAL OUT (square optical connector jack, rear panel)	
Wave length:	660 nm
Output level:	-18 dBm

### Tape player section

Recording system	4-track 2-channel stereo
Frequency Response (DOLBY NR OFF)	40 - 13,000 Hz ( $\pm 3$ dB), using a Sony TYPE I cassette
	40 - 14,000 Hz ( $\pm 3$ dB), using a Sony TYPE II cassette
Wow and flutter	$\pm 0.15$ % W.Peak (IEC) 0.1 % W.RMS (NAB) $\pm 0.2$ % W.Peak (DIN)

### Tuner section

FM Stereo, FM/AM superheterodyne tuner

#### FM tuner section

Tuning range	
North American models:	87.5 - 108.0 MHz (100 kHz step)
Other models:	87.5 - 108.0 MHz (50kHz step)
Antenna	FM Wire antenna
Antenna terminals	75 ohm unbalanced
Intermediate frequency	10.7 MHz

### AM tuner section

Tuning range	
Pan-American models:	530 - 1,710 kHz (with the tuning interval set at 10 kHz) 531 - 1,710 kHz (with the tuning interval set at 9 kHz)
European and Middle Eastern models:	531 - 1,602 kHz (with the tuning interval set at 9 kHz)
Other models:	531 - 1,602 kHz (with the tuning interval set at 9 kHz) 530 - 1,710 kHz (with the tuning interval set at 10 kHz)
Antenna	AM loop antenna, External antenna terminals
Intermediate frequency	450 kHz

### Speakers

#### SS-LX50 for LBT-LX50/LX30

Speaker System	3-way BUILT IN SW
Speaker units	
Woofers:	17 cm dia., cone type
Tweeter:	2.5 cm dia., horn type
Rated impedance:	6 ohms
Dimensions(w/h/d)	Approx. 255 x 530 x 325 mm
Mass	Approx. 10 kg net per speaker

#### SS-LX8G\* or LX8 for LBT-LX8

Speaker System	3-way BUILT IN SW, Magnetically shielded type
Speaker units	
Super Woofer:	20 cm dia., cone type
Tweeter:	2.5 cm dia., horn type
Rated impedance:	4 ohms
Dimensions(w/h/d)	Approx. 290 x 615 x 435 mm
Mass	Approx. 16 kg net per speaker

\* For LBT-LX8 (Middle Eastern, Australian, and New Zealand models) only.

#### SS-LX7 for LBT-LX7

Speaker System	3-way BUILT IN SW, Magnetically shielded type
Speaker units	
Super Woofer:	20 cm dia., cone type
Tweeter:	2.5 cm dia., horn type
Rated impedance:	6 ohms
Dimensions(w/h/d)	Approx. 290 x 615 x 435 mm
Mass	Approx. 16 kg net per speaker

## SS-LX6 for LBT-LX6

Speaker System	3-way BUILT IN SW, Magnetically shielded type
Speaker units	
Woofer:	17 cm dia., cone type
Tweeter:	2.5 cm dia., horn type
Rated impedance:	6 ohms
Dimensions(w/h/d)	
Mexican model:	Approx. 255 x 530 x 325 mm
Other models:	Approx. 255 x 530 x 385 mm
Mass	Approx. 10 kg net per speaker

## SS-LX5 for LBT-LX5

Speaker System	3-way BUILT IN SW
Speaker units	
Woofer:	17 cm dia., cone type
Tweeter:	2.5 cm dia., horn type
Rated impedance:	6 ohms
Dimensions(w/h/d)	
North American model:	Approx. 255 x 530 x 385 mm
Mass	Approx. 10 kg net per speaker

## General

Power Requirements	
North American models:	120 V AC, 60 Hz
European models:	230 V AC, 50/60 Hz
Mexican model:	120 V AC, 50/60 Hz
Australian model:	230 - 240 V AC, 50/60 Hz
Other models:	120 V, 220 V, or 230 - 240 V AC, 50/60 Hz Adjustable with voltage selector

Power Consumption	
U.S.A models: (LBT-LX50/LX30)	270 watts
Canadian model: (LBT-LX50)	390 VA
European models: (LBT-LX7) (LBT-LX5)	220 watts 220 watts
Other models: (LBT-LX8) (LBT-LX6)	300 watts 180 watts

Dimensions(w/h/d)	Approx. 356 x 423 x 446 incl. projecting parts and controls
-------------------	---

Mass	
(LBT-LX50/LX30)	Approx. 13.5 kg
(LBT-LX7)	Approx. 15.6 kg
(LBT-LX5)	Approx. 13.5 kg
(LBT-LX8)	Approx. 15.7 kg
(LBT-LX6)	Approx. 14.8 kg

Supplied Accessories	AM loop antenna (1) FM wire antenna (1) Speaker cords (2) Remote (1) R6(size AA) batteries (2)
----------------------	--

## Optional accessory (LBT-LX50 (Canadian model only))

### Surround Speaker SS-SR125

Speaker system	Full range, bass-reflex type
Speaker units	
Full range:	8 cm dia., cone type
Rated impedance:	16 ohms
Dimensions(w/h/d)	Approx. 220 x 100 x 195 mm
Mass	Approx. 1.0 kg net per speakers

Design and specifications are subject to change  
without notice.

# Index

## A

- Adjusting
  - the audio emphasis 30
  - the sound 28
  - the volume 12, 14, 17
- AMS 12, 16
- Antennas 6, 44
- Audio emphasis 29, 30
- Automatic Source Selection 12, 14, 17

## B

- Batteries 7

## C

- CD player 11, 19
- CD Synchro Recording 12
- Clock setting 7
- Connecting 5~7, 41~45

## D, E

- Daily timer 38
- Display 4, 19, 30
- DJ MIX\*\* 42
- Dubbing 18

## F, G

- Flash 27
- Guitar 43

## H, I, J

- Hooking up
  - optional components 41
  - optional speakers 42
  - speakers 5
    - the antennas 6, 44
    - the power 6
    - the system 5

## K

- Karaoke 35
  - to reduce the vocals (KARAOKE) 36

## L, M

- Loop 27
- Microphone
  - mixing 36
- Mixing sound 36

## N

- Normal Play 11
- Non-Stop Play 23

## O

- One Touch Play 12, 14, 17

## P, Q

- Personal File 32
- Playing
  - a CD 11
  - a preset radio station 13
  - a tape 16
  - tracks in random order (Shuffle Play) 20
  - tracks in the desired order (Program Play) 21
  - tracks repeatedly (Repeat Play) 20
  - without interruption 23
- Presetting radio stations 8
- Preset tuning 13
- Program Edit 25
- Program Play 21
- Protecting recordings 46
- PTY\* 33

## R

- Radio stations
  - presetting 8
  - tuning in 13
- RDS\* 33

## Recording

- a CD 12
- a radio program 15
- another tape (High-Speed dubbing) 18
- CDs by specifying the track order 25
- on a tape manually 24
- selecting tape length automatically 26
- timer-recording 39
- Repeat Play 20
- Resetting the system 49

## S

- Saving power 10
- Saving recordings 46
- Setting the time 7
- Shuffle Play 20
- Sleep Timer 37
- Sound adjustment 28
- Speakers 5, 42
- Surround effect 31
- SYNC BASS 28
- SYNC EQ 29

## T, U, V, W, X, Y, Z

- Tape Select Edit 26
- Timer
  - falling asleep to music 37
  - timer-recording 39
  - waking up to music 38
- Troubleshooting 47
- Tuner 8, 13, 15
- Tuning interval 9
- Turntable 41

\* For European models only

\*\* For European, North American, and Mexican models only