

Quick Setup Guide/Guía de ajuste rápido

DAV-DZ390K/DZ590K/DZ690K

For details, see the Operating Instructions.
Para obtener más información, consulte el Manual de instrucciones.

1 Connecting the speakers/Conexión de los altavoces

2 Connecting the TV/Conexión del televisor

Connect the speaker cords to match the color of the SPEAKER jacks of the unit.
Conecte los cables de altavoz de modo que coincidan con el color de las tomas SPEAKER de la unidad.

Depending on the jacks on your TV, select the video and audio connection method.
En función de las tomas del televisor, seleccione el método de conexión de audio y vídeo.

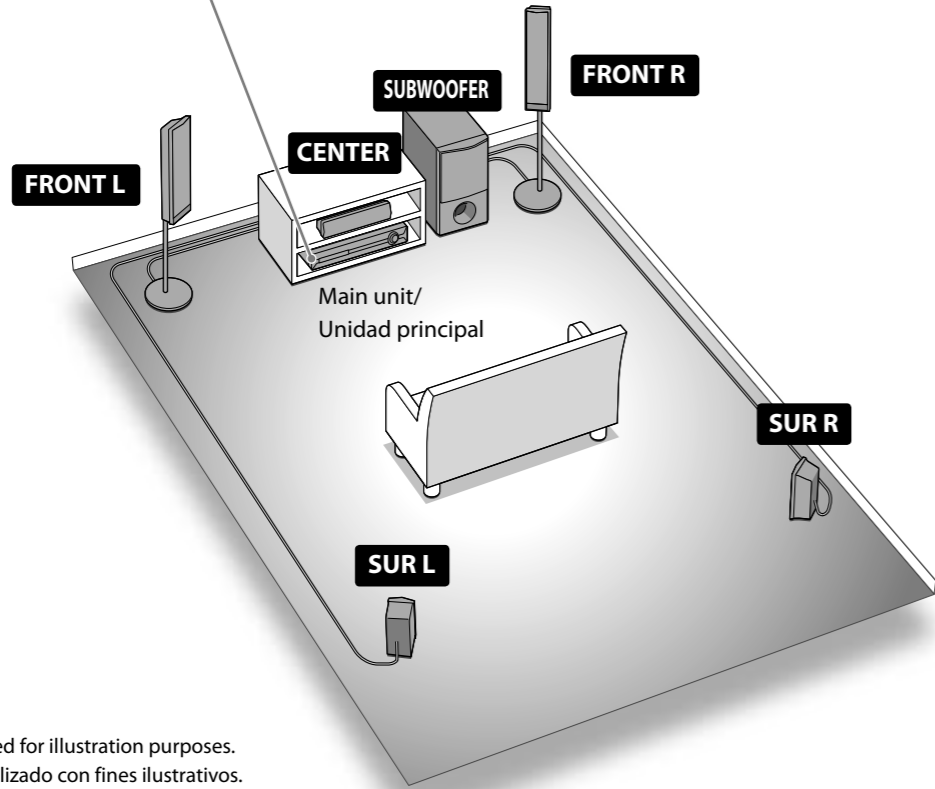
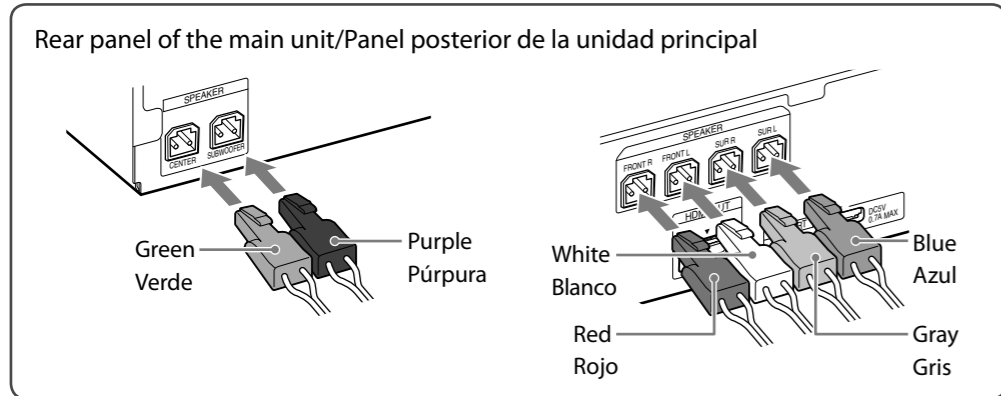

DAV-DZ590K is the model used for illustration purposes.
DAV-DZ590K es el modelo utilizado con fines ilustrativos.

To connect speaker cords to the speaker/Para conectar los cables de altavoz al altavoz

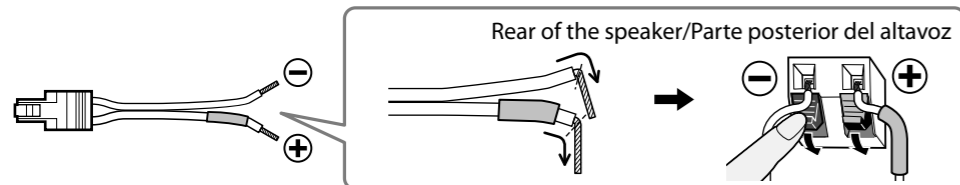

Video connection method/Método de conexión de vídeo

Method 1/Método 1

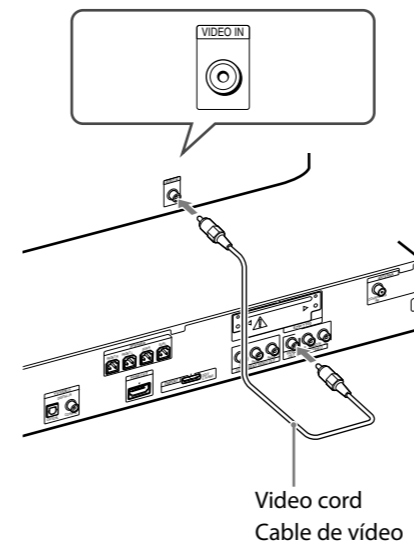

Method 2/Método 2

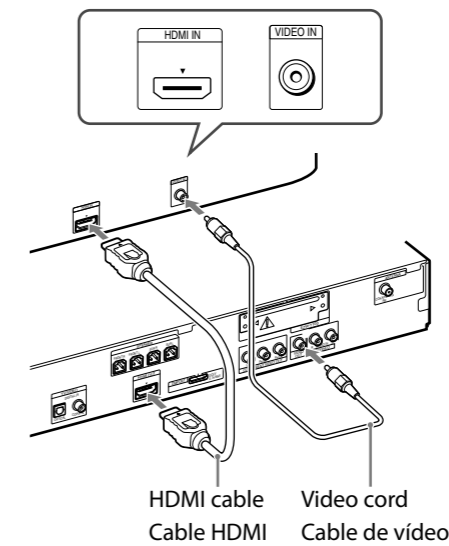

Method 3/Método 3

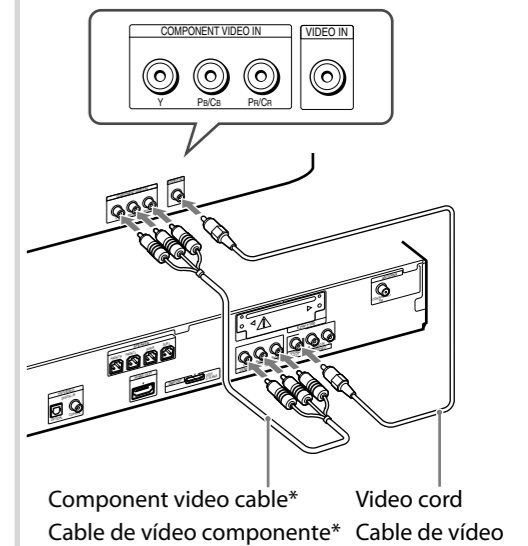

*Not supplied/No suministrado

Audio connection method/Método de conexión de audio

Method 1/Método 1

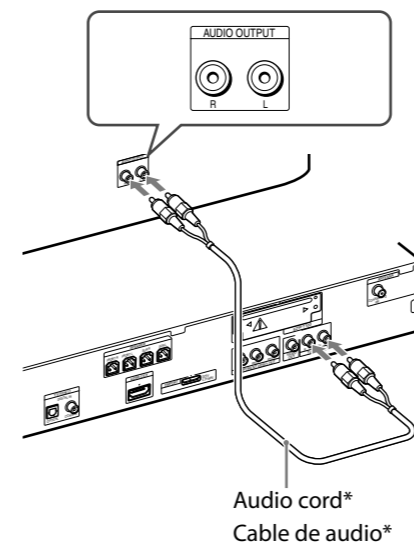

Method 2/Método 2

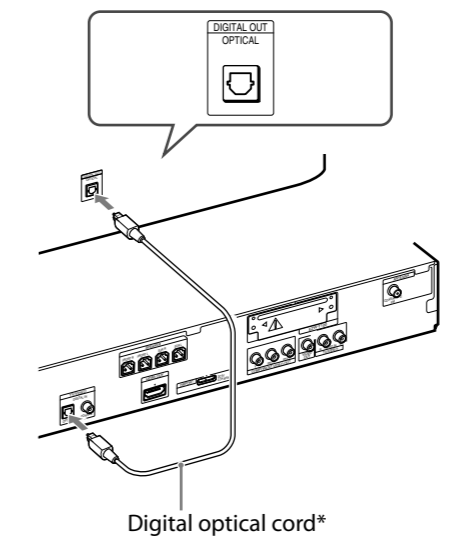

Method 3/Método 3

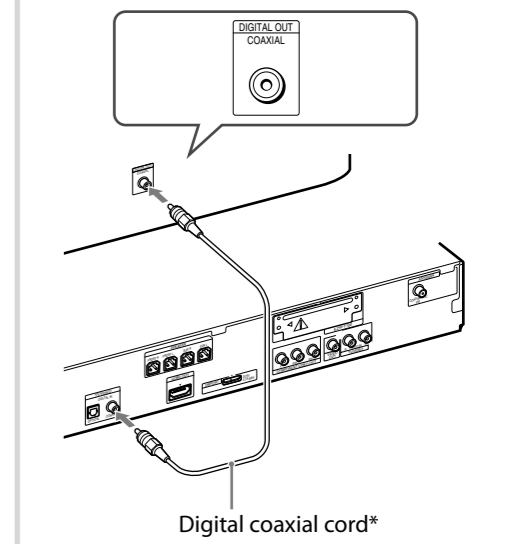

*Not supplied/No suministrado

3 Performing the Quick Setup/Realización del ajuste rápido

Listening to TV sound from all speakers/
Audición del sonido del televisor a través de todos los altavoces

Note
Do not insert a disc before performing the Quick Setup.

Nota
No inserte ningún disco antes de realizar el ajuste rápido.

- 1 Connect the AC power cord.**
The shape of the wall outlet differs depending on the area.
Conecte el cable de alimentación de ca.
La forma de la toma de pared varía en función de la zona.

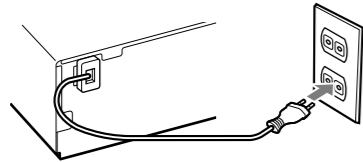

- 2 Turn on the power of the main unit and TV.**
Encienda la unidad principal y el televisor.

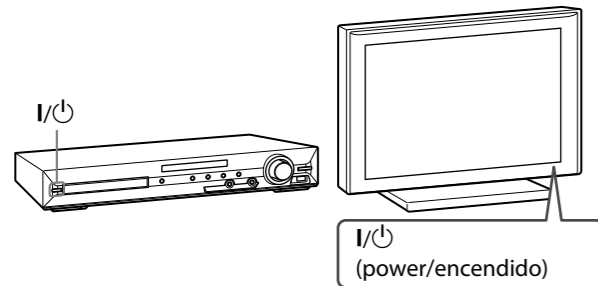

- 3 Switch the input selector on your TV to display "SONY Home Theatre System."**
Cambie el ajuste del selector de entrada del televisor para visualizar "SONY Home Theatre System".

- 4 Set each following item, using ←/↑/↓/→ and ⊕.**
Ajuste cada uno de los elementos siguientes mediante ←/↑/↓/→ y ⊕.

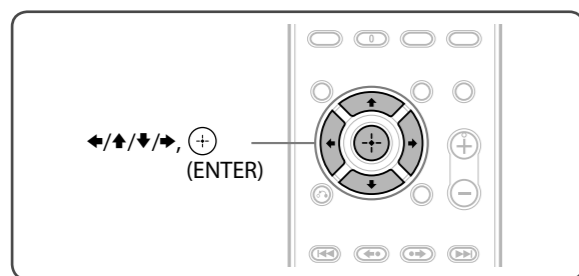

Note
Displayed items vary depending on the area.

Nota
Los elementos que aparecen varían en función de la zona.

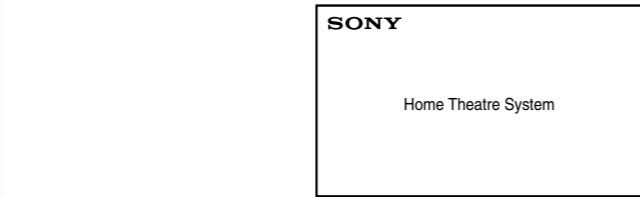

Select an on-screen language.
Seleccione un idioma para las indicaciones en pantalla.

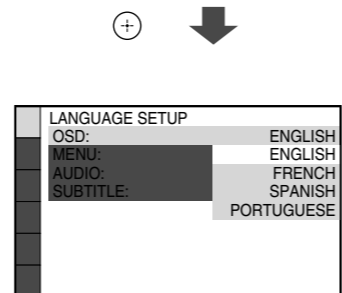

Select the aspect ratio of the connected TV.
Seleccione el formato del televisor conectado.

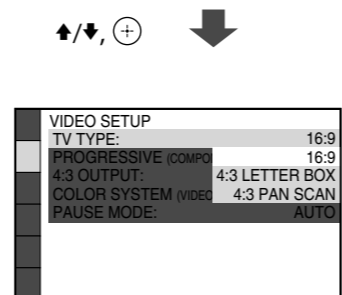

Select [ON] when you connect the main unit and the TV with an HDMI cable.
Seleccione [SI] si conecta la unidad principal y el televisor con un cable HDMI.

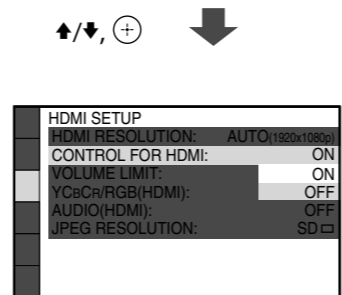

Select the speaker formation.
Seleccione la disposición de los altavoces.

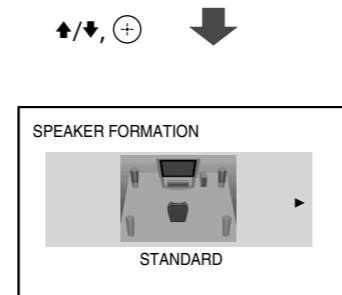

Connect the calibration mic and set it at the listening position.

Conecte el micrófono de calibración y ajústelo en la posición de escucha.

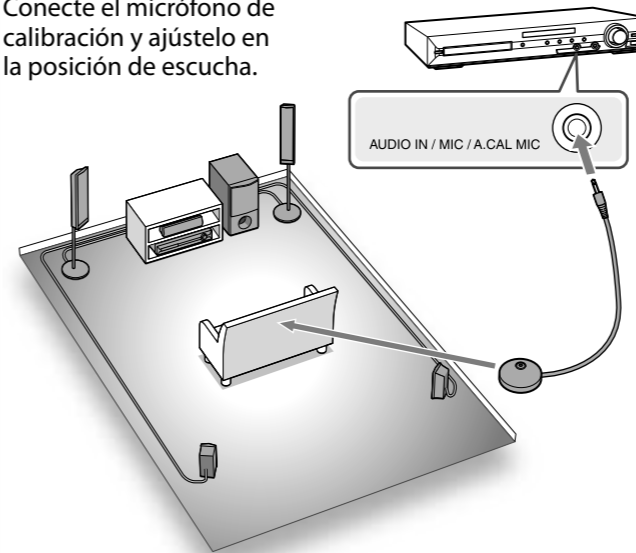

Select [YES] to perform [AUTO CALIBRATION].
Seleccione [SI] para ejecutar la función [CALIBRAC. AUTOM.].

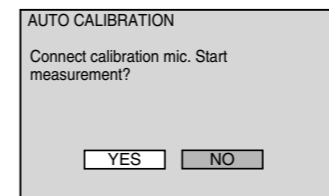

Select [YES] to save the measurement results.
Seleccione [SI] para guardar los resultados de la medición.

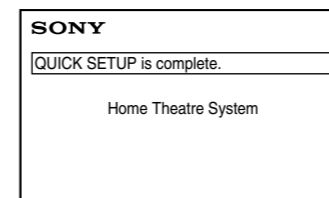
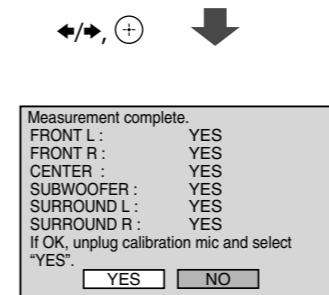

- 1 Press FUNCTION to display "TV/VIDEO."**
Pulse FUNCTION hasta que aparezca "TV/VIDEO".

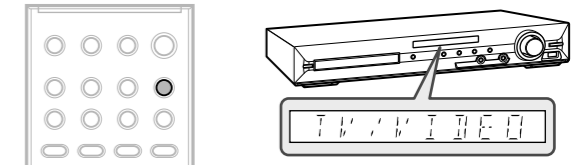

- 2 Press SYSTEM MENU.**
Pulse SYSTEM MENU.

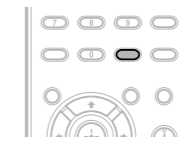

- 3 Press ↑/↓ to display "DEC. MODE," then press ⊕.**
Pulse ↑/↓ hasta que aparezca "DEC. MODE" y, a continuación, pulse ⊕.

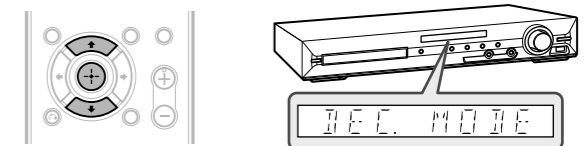

- 4 Press ↑/↓ to display "PRO LOGIC," then press ⊕.**
Pulse ↑/↓ hasta que aparezca "PRO LOGIC" y, a continuación, pulse ⊕.

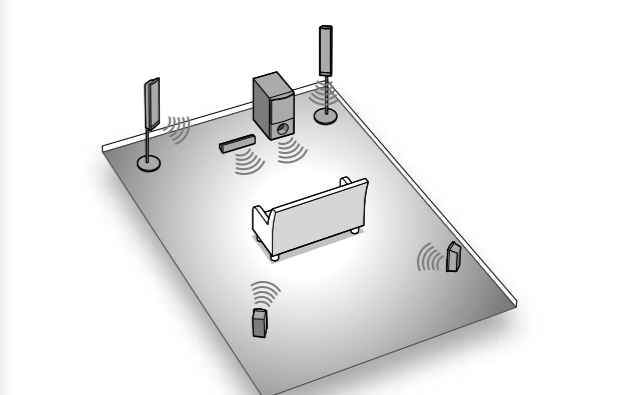
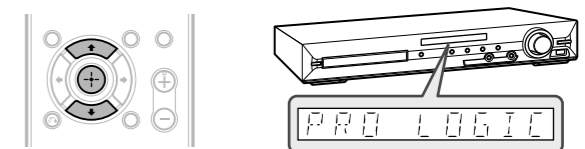

- 5 Press SYSTEM MENU to exit the menu.**
Pulse SYSTEM MENU para salir del menú.