

# *Trinitron Color TV*

---

## Operating Instructions \_\_\_\_\_

**GB**



- Before operating the unit, please read this manual thoroughly and retain it for future reference.

**FD Trinitron**  
**WEGA**

*KV-HW21*

# WARNING

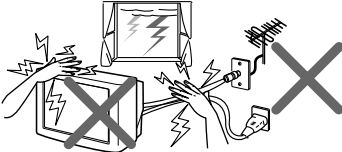
- Dangerously high voltages are present inside the TV.
- TV operating voltage: 110 – 240 V AC.
- Do not plug in the power cord until you have completed making all other connections; otherwise a minimum leakage current might flow through the antenna and other terminals to ground.
- To avoid battery leakage and damage to the remote, remove the batteries from the remote if you are not going to use it for several days. If any liquid leaks from the batteries and touches your skin, immediately wash it away with water.

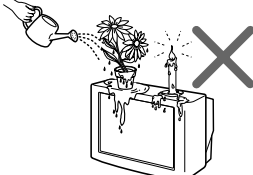
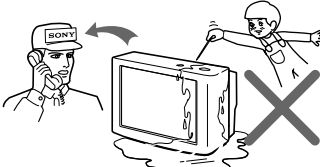
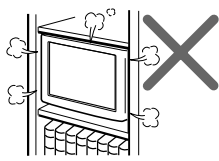
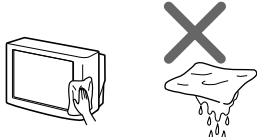
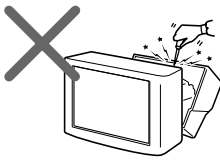
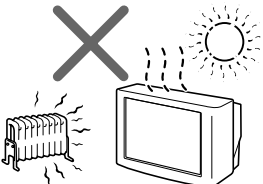
 <p>For your own safety, do not touch any part of the TV, the power cord and the antenna cable during lightning storms.</p>	 <p>For children's safety, do not leave children alone with the TV. Do not allow children to climb onto it.</p>
 <p>Do not place any objects on the TV. The apparatus shall not be exposed to dripping or splashing and that no objects filled with liquids, such as vases, shall be placed on the apparatus.</p>	 <p>Do not operate the TV if any liquid or solid object falls into it. Have it checked immediately by qualified personnel only.</p>
 <p>Do not block the ventilation openings of the TV. Do not install the TV in a confined space, such as a bookcase or built-in cabinet.</p>	 <p>Clean the TV with a dry and soft cloth. Do not use benzine, thinner, or any other chemicals to clean the TV. Do not attach anything (e.g., adhesive tape, cellophane tape, glue) on the painted cabinet of the TV. Do not scratch the picture tube.</p>
 <p>Do not open the cabinet and the rear cover of the TV as high voltages and other hazards are present inside the TV. Refer servicing and disposal of the TV to qualified personnel.</p>	 <p>Your TV is recommended for home use only. Do not use the TV in any vehicle or where it may be subject to excessive dust, heat, moisture or vibrations.</p>

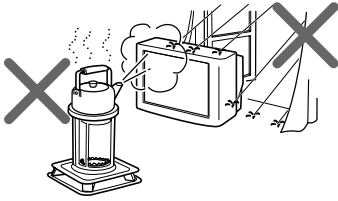

To prevent fire or shock hazard, do not expose the TV to rain or moisture.

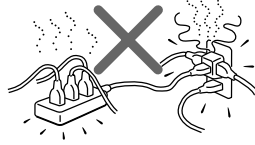

Do not plug in too many appliances to the same power socket. Do not damage the power cord.

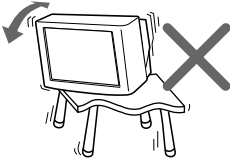

Install the TV on a stable TV stand and floor which can support the TV set weight. Ensure that the TV stand surface is flat and its area is larger than the bottom area of the TV.

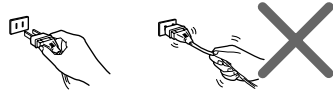

Pull the power cord out by the plug. Do not pull the power cord itself. Even if your TV is turned off, it is still connected to the AC power source (mains) as long as the power cord is plugged in. Unplug the TV before moving it or if you are not going to use it for several days.

# ■ Securing the TV

To prevent the TV from falling, use the supplied screws, clamps and band to secure the TV.

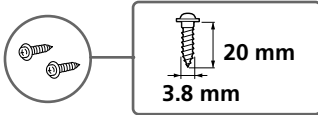

screws



clamps

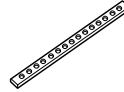

band

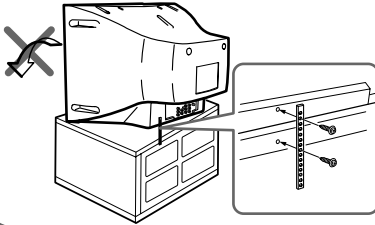

Screw the band to the TV stand and to the provided hole at the rear of your TV.

**or**

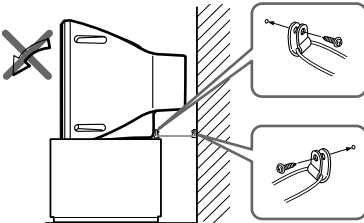

- (1) Put a cord or chain through the clamps.
- (2) Screw one clamp to a wall or pillar and the other clamp to the provided hole at the rear of your TV.

## Note

- Use only the supplied screws. Use of other screws may damage the TV.



## ■ Getting Started

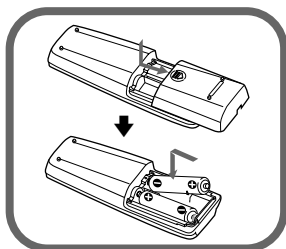

### Step 1

Insert the batteries (supplied) into the remote.

#### Note

- Do not use old or different types of batteries together.

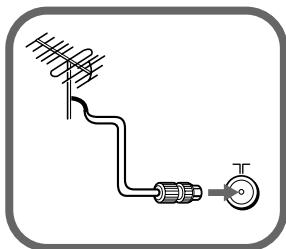

### Step 2

Connect the antenna cable (not supplied) to  $\Upsilon$  (antenna input) at the rear of the TV.

#### Tip

- You can also connect your TV to other optional components (see page 22).

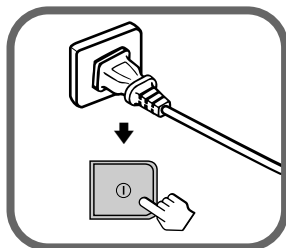

### Step 3

Plug in the power cord, then press  $\text{⏻}$  on the TV to turn it on.

#### Note

- The  $\text{⏻}$  (standby) indicator flashes green for a few seconds when turning on the TV. This does not indicate a malfunction.

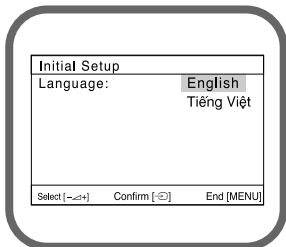



### Step 4



Set up the TV by following the instructions of the "Initial Setup" menu (see page 7).

# ■ Setting up your TV ("Initial Setup")

When you turn on your TV for the first time, the "Initial Setup" menu will appear. You may change the menu language, preset the TV channels automatically and adjust the picture position using the buttons on the top control panel.



## Tip

- The MENU,  and  buttons on the remote control can also be used for the operations below.

- 1 Press  +/- to select the desired menu language, then press .

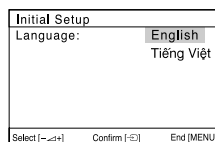
The selected menu language appears.





- 2 Press  +/- to select "Yes", then press  to preset the channels automatically or select "No" to skip automatic channel presetting.

Once you select "Yes", your TV will start searching for all the available channels.

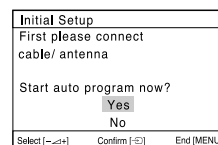

If the message "No channel found. Please connect cable/antenna." appears, check your TV connections, then press .

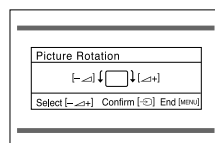

- 3 Press  +/- to adjust the bars on the top and bottom of the menu if they are slanted, then press .

If no adjustment is necessary, then press .



- 4 Press  +/- to select "No", then press . This menu will not appear again the next time you turn on the TV by pressing .

To allow this menu to appear again, select "Yes", then press .

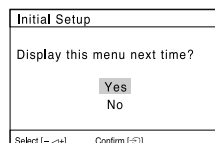

## Tips

- You can immediately go to the end of the "Initial Setup" menu by pressing MENU.
- You can also set up your TV by pressing the MENU button on the top control panel for about five seconds or using the menu system (see page 12).

## TV top control, front and rear panels

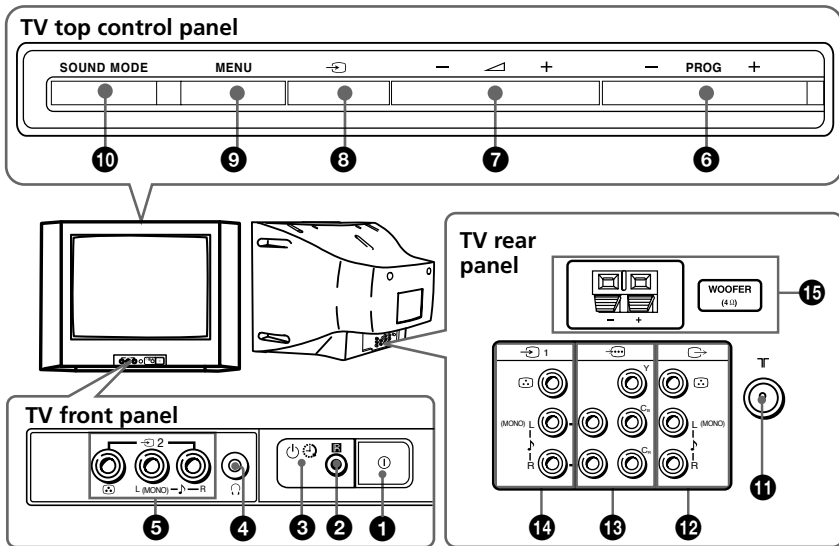

Button/Terminal	Function	Page
① ①	Turn off or turn on the TV.	6
②	Remote control sensor.	–
③	Wake Up indicator.	18
③	Standby indicator.	6
④	Headphone jack.	–
⑤	Video input terminal 2.	22
⑥ PROG +/-	Select program number.	–
⑦	Adjust volume.	–
⑧	Select TV or video input.	22
<b>Menu operations</b>		
⑦	Select and adjust items.	–
⑧	Confirm selected items.	–
⑨ MENU	Display or cancel the menu.	–
⑩ SOUND MODE	Select sound mode options with a 5-Band Graphic Equalizer display.	11
⑪	Antenna input terminal.	22
⑫	Monitor output terminal.	23
⑬	Component video input terminal.	23
⑭	Video input terminal 1.	22
⑮ WOOFER (KV-HW21M53 only)	Enjoy high quality sound.	22





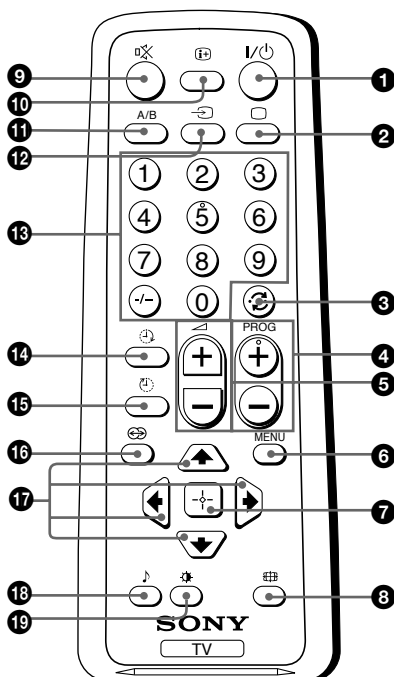



# ■ Using the remote control and basic functions



Button	Description	Page
1 I/⏻	Turn off temporarily or turn on the TV.	-
2 □	Display the TV program.	-
3 ⏮	Jump to previous program number.	-
4 PROG +/-	Select program number.	-
5 ▽ +/-	Adjust volume.	-
8 📺	Change the picture size: "On" (16:9 wide-mode), "Off".	-
9 🔇	Mute the sound.	-
10 ⓘ	Display on-screen information.	-
12 📺	Select TV or video input.	22
13 0 - 9, +/-	Input numbers.	-
16 🎧	Select surround mode options: "On" (surround), "Simulated" (stereo-like monaural sound), "Off".	-

**continue**

**continued**

<b>Button</b>	<b>Description</b>	<b>Page</b>
<b>18</b> 	Select sound mode options with a 5-Band Graphic Equalizer display.	11
<b>19</b> 	Select picture mode options.	11
<b>Menu operations</b>		
<b>6</b> MENU	Display or cancel the menu.	14
<b>7</b> 	Confirm selected items.	14
<b>17</b> 	Select and adjust items.	14
<b>Timer operations</b>		
<b>14</b> 	Set TV to turn on automatically.	-
<b>15</b> 	Set TV to turn off automatically.	-
<b>Stereo/bilingual operations</b>		
<b>11</b> A/B	Not function for your TV.	-

## ■ Selecting the picture and sound modes

You can select picture and sound modes and adjust the setting to your preference in the “Personal” option.

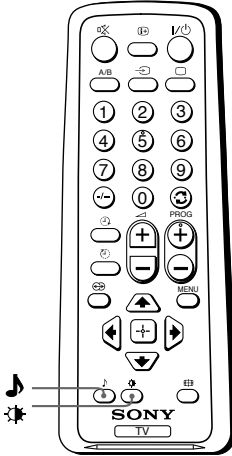



### Selecting the picture mode

Press to select the desired picture mode.

Select	To view
“Dynamic”	high contrast pictures.
“Standard”	normal pictures.
“Soft”	mild pictures.
“Personal”	the last adjusted picture setting from the “Picture Adjustment” option in the menu (see page 15).

### Selecting the sound mode

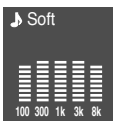
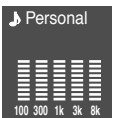

Press (or SOUND MODE on the top control panel) to select the desired sound mode with a 5-Band Graphic Equalizer display.

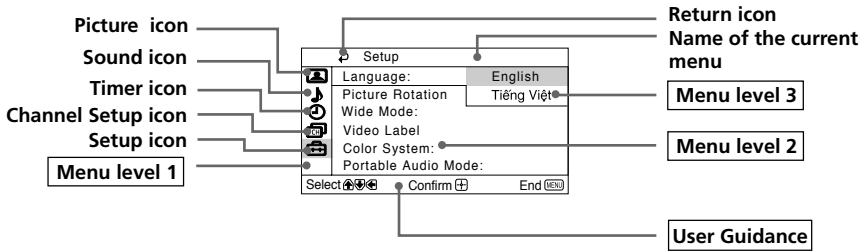

Select	To listen to
“Dynamic” 	dynamic and clear sound that emphasizes both the low and high tones.
“Drama” 	sound that emphasizes voice and high tones.
“Soft” 	soft, natural and relaxing sounds.
“Personal” 	the last adjusted sound setting from the “Sound Adjustment” option in the menu (see page 17).

## Introducing the menu system

The MENU button lets you open a menu and change the settings of your TV. The following is an overview of the menu system.



Level 1	Level 2	Level 3/Function	Page
"Picture" 	"Mode"	Select the picture mode: "Dynamic" → "Standard" → "Soft" → "Personal"	15
	"Picture Adjustment"	Adjust the "Personal" option: "Picture" → "Brightness" → "Color" → "Hue" → "Sharpness" → "Reset"	
	"Color Temperature"	Adjust white color tint: "Cool" → "Neutral" → "Warm"	
	"Intelligent Picture"	Optimize picture quality: "On" → "Off"	
"Sound" 	"Mode"	Select the sound mode: "Dynamic" → "Drama" → "Soft" → "Personal"	16
	"Sound Adjustment"	Adjust sound frequency settings of "Personal" option: "Adjust" → "Reset"	
	"Balance"	Select to emphasize the left and right speakers.	
	"Intelligent Volume"	Adjust volume automatically: "On" → "Off"	
	"Surround"	Select the surround mode: "On" → "Simulated" → "Off"	

Level 1	Level 2	Level 3/Function	Page
"Timer" 	"Sleep Timer"	Set TV to turn off automatically.	18
	"Wake Up Timer"	Set TV to turn on automatically.	
"Channel Setup" 	"Auto Program"	Preset channels automatically.	19
	"Manual Program"	Preset channels manually.	
	"TV System"	Select the TV system: "B/G" → "I" → "D/K" → "M"	
	"Program Label"	Label the program number.	
	"Program Block"	Block unwanted programs.	
"Setup" 	"Language"	Change the menu language: "English" → "Tiếng Việt" (Vietnamese)	21
	"Picture Rotation"	Adjust the picture position.	
	"Wide Mode"	Change the picture size: "On" (16:9 wide-mode) → "Off"	
	"Video Label"	Label the connected equipment.	
	"Color System"	Select the color system: "Auto" → "PAL" → "SECAM" → "NTSC3.58" → "NTSC4.43"	
	"Portable Audio Mode"	Select the input connected to your audio equipment: "Video1" → "Video2" → "Off"	

## How to use the menu

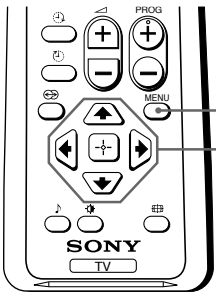

**Press MENU to display the menu.**

 →

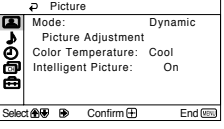

**Press  $\uparrow$  or  $\downarrow$  to select the desired item.**

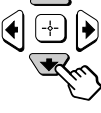
 →

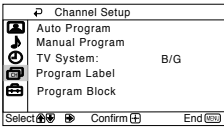

**Press  $\rightarrow$  (or  $\leftarrow$ ) to confirm your selection and go to the next level.**

 →

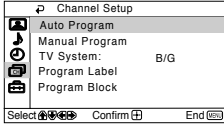

### Other menu operations

To	Press
Adjust the setting value	$\uparrow$ , $\downarrow$ , $\leftarrow$ or $\rightarrow$ .
Move to the next/previous menu level	$\leftarrow$ or $\rightarrow$ .
Cancel the menu	MENU.

### Tips

- If you want to exit from Menu level 2 to Menu level 1, press  $\uparrow$  or  $\downarrow$  until the return icon ( $\rightarrow$ ) is highlighted, then press  $\rightarrow$ .
- The MENU,  $\rightarrow$  and  $\leftarrow$  +/- buttons on the top control panel can also be used for the operations above (see page 8).

# ■ Changing the “Picture” setting

The “Picture” menu allows you to adjust the picture settings.

**1** Press MENU.

**2** Make sure the “Picture” icon (🖼️) is selected, then press (↵).

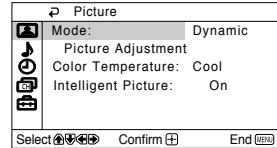

**3** Press ↑ or ↓ to select the desired item (e.g., “Mode”), then press (↵).

Select	To
“Mode”	choose either “Dynamic”, “Standard”, “Soft” or “Personal”* (see page 11).
“Color Temperature”	adjust white color tint. Choose either “Cool” (blue tint), “Neutral” (neutral tint) or “Warm” (red tint).
“Intelligent Picture”	optimize picture quality. Press ↑ or ↓ to select “On”, then press (↵). To cancel, select “Off”, then press (↵).

\* You can adjust the setting to your personal preference in the “Picture Adjustment” and “Color Temperature” options only when the “Personal” mode is selected.

## Adjusting the “Picture Adjustment” items under “Personal” mode

**1** Press ↑ or ↓ to select either “Picture” (contrast), “Brightness”, “Color”, “Hue” (color tones) or “Sharpness”, then press (↵).

Selecting “Reset” will set your TV to the factory setting.

**2** Press ↑, ↓, ← or → to adjust the setting of your selected item, then press (↵).

**3** Repeat the above steps to adjust other items.

The adjusted settings will be received when you select “Personal”.

### Notes

- “Hue” can be adjusted for the NTSC color system only.
- Reducing “Sharpness” can also reduce picture noise.

# ■ Changing the “Sound” setting

The “Sound” menu allows you to adjust the sound settings.

**1** Press MENU.

**2** Press **↑** or **↓** to select the “Sound” icon (🔊), then press **↵**.

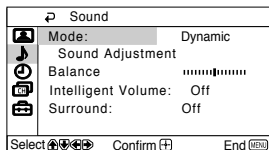

**3** Press **↑** or **↓** to select the desired item (e.g., “Mode”), then press **↵**.

Select	To
“Mode”	choose either “Dynamic”, “Drama”, “Soft” or “Personal”* (see page 11).
“Balance”	Press <b>↓</b> or <b>←</b> to emphasize the left speaker. Press <b>↑</b> or <b>→</b> to emphasize the right speaker.
“Intelligent Volume”	adjust the volume of all program numbers and video inputs automatically. Press <b>↑</b> or <b>↓</b> to select “On”, then press <b>↵</b> . To cancel, select “Off”, then press <b>↵</b> .
“Surround”	choose either “On”, “Simulated” or “Off” (see page 9).

\* You can adjust the setting to your personal preference in the “Sound Adjustment” option only when the “Personal” mode is selected (see page 17).



---





## Adjusting the “Sound Adjustment” item under “Personal” mode

The 5-Band Graphic Equalizer feature allows you to adjust sound frequency settings of “Personal” mode in the menu.

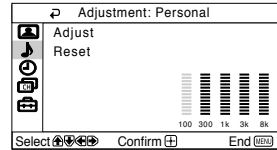
- 1 Make sure that “Adjust” is selected, then press .

Selecting “Reset” will set your TV to the factory setting.



- 2 Press  or  to select the desired sound frequency, then press  or  to adjust the setting and press .

The adjusted settings will be received when you select “Personal”.

---

### Notes

- Adjusting higher frequency will affect higher pitched sound and adjusting lower frequency will affect lower pitched sound.
- You may display the settings directly using the SOUND MODE button on the top control panel (see page 8) or  button on the remote control (see page 10).

# ■ Changing the “Timer” setting

The “Timer” menu allows you to set TV to turn off and turn on automatically.

**1** Press MENU.

**2** Press **▲** or **▼** to select the “Timer” icon (⌚), then press **⏏**.

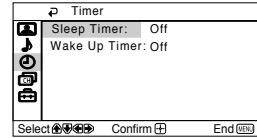

**3** Press **▲** or **▼** to select the desired item (e.g., “Sleep Timer”), then press **⏏**.

Select	To
“Sleep Timer”	set TV to turn off automatically. Press <b>▲</b> or <b>▼</b> to select the desired period of time (max. of 1 hour and 30 minutes), then press <b>⏏</b> .
“Wake Up Timer”	set TV to turn on automatically. Press <b>▲</b> or <b>▼</b> to select the desired period of time (max. of 12 hours), then press <b>⏏</b> . After the selected length of time, the TV switches on automatically and “Wake Up Timer” will appear on the screen.  The ⌚ indicator on the TV lights up amber once you set the “Wake Up Timer”.

## Notes

- You can also cancel “Sleep Timer” and “Wake Up Timer” by turning off the TV’s main power.
- If no buttons or controls are pressed for more than one hour after the TV is turned on using the “Wake Up Timer”, the TV automatically goes into standby mode.

# ■ Changing the “Channel Setup” setting

The “Channel Setup” menu allows you to preset channels automatically, manually preset channels, select the TV system, label the program number and block unwanted programs.

**1** Press MENU.

**2** Press  $\uparrow$  or  $\downarrow$  to select the “Channel Setup” icon (☰), then press  $\leftarrow$ .

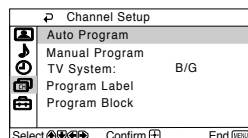

**3** Press  $\uparrow$  or  $\downarrow$  to select the desired item (e.g., “Auto Program”), then press  $\leftarrow$ .

Select	To
“Auto Program”	preset channels automatically.
“Manual Program”	manually preset desired channels and channels that cannot be preset automatically (see <b>Presetting channels manually</b> on page 20).
“TV System”	select the TV system. Press $\uparrow$ or $\downarrow$ to select either “B/G”, “I”, “D/K” or “M”, then press $\leftarrow$ .
“Program Label”	label the program number. (1) Select “Program” and press $\leftarrow$ . Press $\uparrow$ or $\downarrow$ to select the program number, then press $\leftarrow$ . (2) Select “Label” and press $\leftarrow$ , then press $\uparrow$ or $\downarrow$ to select alphanumeric characters for the label.
“Program Block”	block unwanted programs. (1) Select “Program” and press $\leftarrow$ . Press $\uparrow$ or $\downarrow$ to select the program number, then press $\leftarrow$ . (2) Select “Block” and press $\leftarrow$ , then press $\uparrow$ or $\downarrow$ to choose either “On” or “Off”. If you preset a blocked program number, that program number will be unblocked automatically.

## Note





- During automatic channel presetting, your TV screen will indicate “B/G”, “I”, “D/K” or “M” for the “TV System”.

**continue**

**continued**

## Presetting channels manually

**1** After selecting “Manual Program”, select the program number to which you want to preset a channel.



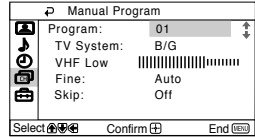



- (1) Make sure “Program” is selected, then press .
- (2) Press  or  until the program number you want to preset appears on the menu, then press .













**2** Select the desired channel.

- (1) Make sure either “VHF Low”, “VHF High” or “UHF” is selected, then press .
- (2) Press  or  until the desired channel’s broadcast appears on the TV screen, then press .

**3** If the sound of the desired channel is abnormal, select the appropriate TV system.







- (1) Press  or  to select “TV System”, then press .
- (2) Press  or  until the sound becomes normal, then press .

**4** If you are not satisfied with the picture and sound quality, you may be able to improve them by using the “Fine” tuning feature.

- (1) Press  or  to select “Fine”, then press .
- (2) Press  or  to select “Manual”, then press .
- (3) Press , ,  or  until the picture and sound quality are optimal, then press .

The + or – icon on the menu flashes while tuning.

**5** If you want to skip this program number when using PROG +/-, you can select the “Skip” feature.

- (1) Press  or  to select “Skip”, then press .
- (2) Press  or  to select “On”, then press .

To cancel, select “Off”, then press .

# ■ Changing the “Setup” setting

The “Setup” menu allows you to change the menu language, adjust the picture position, change the picture size, label the connected equipment, select the color system and enjoy audio equipment sound.

**1** Press MENU.

**2** Press **▲** or **▼** to select the “Setup” icon (📺), then press **⏏**.

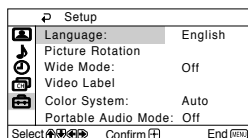

**3** Press **▲** or **▼** to select the desired item (e.g., “Language”), then press **⏏**.

Select	To
“Language”	change the menu language. Press <b>▲</b> or <b>▼</b> to select either “English” or “Tiếng Việt” (Vietnamese), then press <b>⏏</b> .
“Picture Rotation”	adjust the picture position when it is not aligned with the TV screen. Press <b>◀</b> or <b>▶</b> to adjust the picture position, then press <b>⏏</b> .
“Wide Mode”	choose either “On” or “Off” (see page 9).
“Video Label”	label the connected equipment. (1) Select “Video Input” and press <b>⏏</b> . Press <b>▲</b> or <b>▼</b> to select the input you want to label, then press <b>⏏</b> . (2) Select “Label” and press <b>⏏</b> , then press <b>▲</b> or <b>▼</b> to select the label options: “Video 1/Video 2/DVD”, “VCR”, “SAT”, “Game” or “Edit”*.  * You may edit the video label by entering alphanumeric characters.
“Color System”	select the color system. Press <b>▲</b> or <b>▼</b> to select either “Auto”, “PAL”, “SECAM”, “NTSC3.58” or “NTSC4.43”, then press <b>⏏</b> . Normally, set this to “Auto”.
“Portable Audio Mode”	enjoy the sound of audio equipment through the TV speakers while viewing picture from other inputs. Press <b>▲</b> or <b>▼</b> to select the input connected to your audio equipment: “Video1” or “Video2”, then press <b>⏏</b> . You may change the picture while listening to the fixed audio input. To cancel Portable Audio Mode, select “Off” or turn off the TV.

## ■ Connecting the 3D WOOFER

### ▶ KV-HW21M53 only

You can enjoy high quality sound by connecting the 3D WOOFER as follows:

#### Step 1

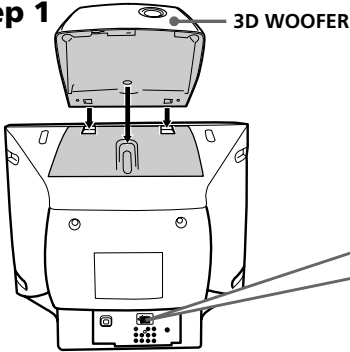

#### Step 2

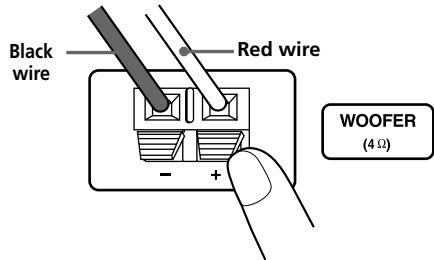

#### Notes

- Connect only the supplied 3D WOOFER; otherwise your TV may malfunction.
- Unplug your TV from the wall outlet when connecting the 3D WOOFER.
- To prevent a malfunction caused by a short circuit of the terminals, make sure that none of the 3D WOOFER wire strands stick out, making contact with the neighbouring 3D WOOFER terminal.

## ■ Connecting optional components

### Connecting to the video input terminal ( → )

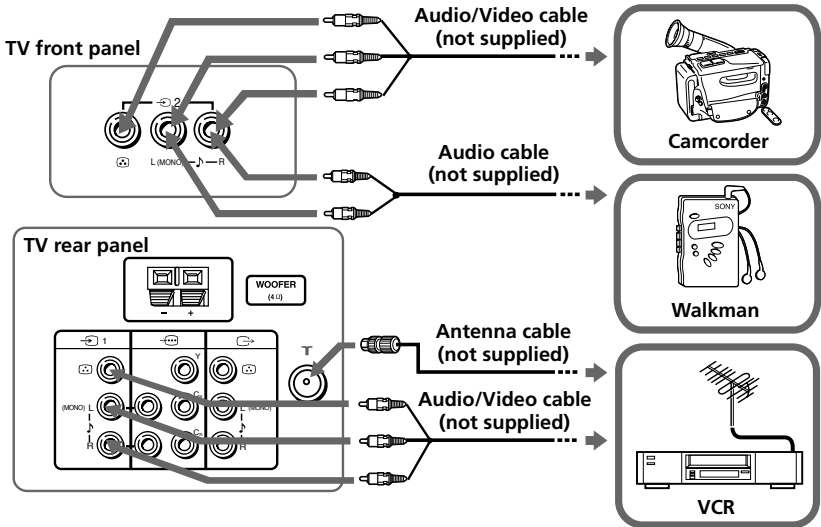

#### Note

- If you connect a VCR to ㊦ (antenna input), preset the signal output from the VCR to the program number 0 on the TV (see page 20).

## Connecting to the monitor output terminal ( )

TV rear panel

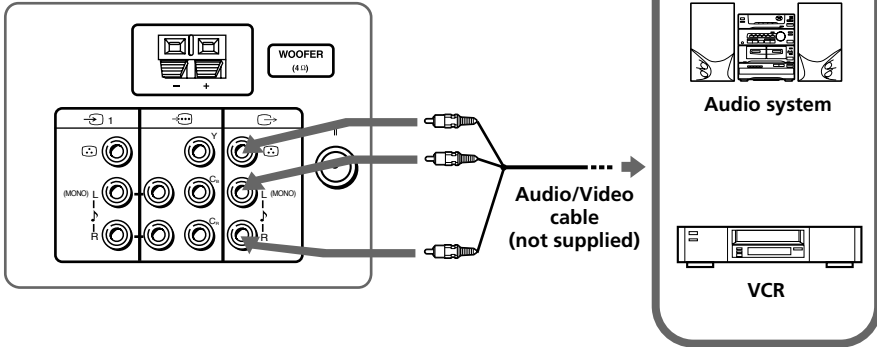

## Connecting to the component video input terminal ( )

TV rear panel

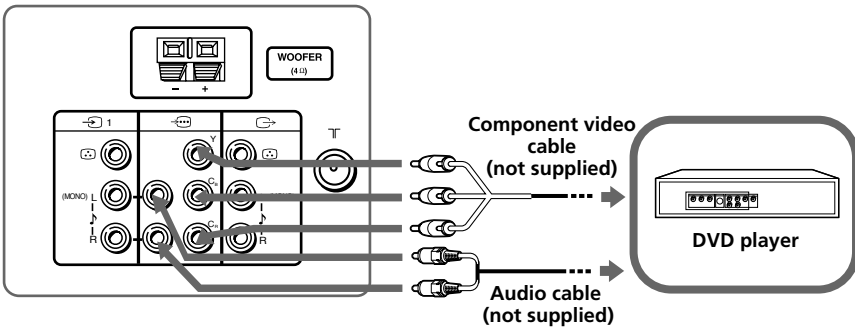

### Notes

- If your DVD player can output interlace and progressive mode signals, select the interlace output when connecting to  (component video input) on your TV. Your TV can receive either 525i/60Hz or 625i/50Hz interlace signals.
- Some DVD player terminals may be labeled differently:







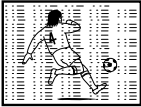

Connect	To (on the DVD player)
Y (green)	Y
C <sub>B</sub> (blue)	C <sub>B</sub> , P <sub>B</sub> , C <sub>b</sub> or B-Y
C <sub>R</sub> (red)	C <sub>R</sub> , P <sub>R</sub> , C <sub>r</sub> or R-Y

- If you select "DVD" on your TV screen, the signal from the  (monitor output) jacks will not be output properly. This does not indicate a malfunction.





# Troubleshooting

If you find any problem while viewing your TV, please check the following guide. If any problem persists, contact your Sony dealer.

## Troubleshooting guide



Symptom	Possible cause	Solutions	Page
<b>Snowy picture</b> 	<ul style="list-style-type: none"> <li>The connection is loose or the cable is damaged.</li> <li>The antenna setup is inappropriate.</li> </ul>	<ul style="list-style-type: none"> <li>Check the antenna cable and connection on the TV, VCR and at the wall.</li> <li>Check the antenna setup. Contact a Sony dealer for advice.</li> </ul>	22 –
<b>Noisy sound</b> 	<ul style="list-style-type: none"> <li>Channel presetting is inappropriate or incomplete.</li> <li>Signal transmission is low.</li> </ul>	<ul style="list-style-type: none"> <li>Display the “Channel Setup” menu and select “Manual Program” to preset the channel again.</li> <li>Try using a booster.</li> </ul>	20 –
<b>Distorted picture</b> 	<ul style="list-style-type: none"> <li>Broadcast signals are too strong.</li> </ul>	<ul style="list-style-type: none"> <li>Turn off or disconnect the booster if it is in use.</li> </ul>	–
<b>Noisy sound</b> 			
<b>Good picture</b> 	<ul style="list-style-type: none"> <li>The TV system setting is inappropriate.</li> </ul>	<ul style="list-style-type: none"> <li>Display the “Channel Setup” menu and select the appropriate “TV System”.</li> </ul>	20
<b>Noisy sound</b> 			
<b>No picture</b> 	<ul style="list-style-type: none"> <li>The power cord, antenna or VCR is not connected.</li> <li>The TV is not turned on.</li> </ul>	<ul style="list-style-type: none"> <li>Check the power cord, antenna and VCR connections.</li> <li>Press I/⏻ (power).</li> <li>Press Ⓛ (main power) on the TV to turn off the TV for about five seconds, then turn it on again.</li> </ul>	22 9 8
<b>No sound</b> 			



Symptom	Possible cause	Solutions	Page
<b>Good picture</b> 	<ul style="list-style-type: none"> <li>The volume level is too low.</li> </ul>	<ul style="list-style-type: none"> <li>Press <math>\triangle</math> + to increase the volume level.</li> </ul>	9
<b>No sound</b> 	<ul style="list-style-type: none"> <li>The sound is muted.</li> </ul>	<ul style="list-style-type: none"> <li>Press <math>\square \times</math> to cancel the muting.</li> </ul>	9
<b>No sound or inappropriate sound</b>	<ul style="list-style-type: none"> <li>The Portable Audio Mode is functioning.</li> </ul>	<ul style="list-style-type: none"> <li>Display the "Setup" menu and set the "Portable Audio Mode" to "Off".</li> </ul>	21
<b>Dotted lines or stripes</b> 	<ul style="list-style-type: none"> <li>There is local interference from cars, neon signs, hair dryers, power generators, etc.</li> </ul>	<ul style="list-style-type: none"> <li>Do not use a hair dryer or other equipment near the TV.</li> <li>Check the antenna setup. Contact a Sony dealer for advice.</li> </ul>	–
<b>Double images or "ghosts"</b> 	<ul style="list-style-type: none"> <li>Broadcast signals are reflected by nearby mountains or buildings.</li> </ul>	<ul style="list-style-type: none"> <li>Use a highly directional antenna.</li> <li>Use the fine tuning ("Fine") function.</li> </ul>	– 20
	<ul style="list-style-type: none"> <li>The antenna setup is inappropriate.</li> </ul>	<ul style="list-style-type: none"> <li>Check the antenna setup. Contact a Sony dealer for advice.</li> </ul>	–
	<ul style="list-style-type: none"> <li>Use of a booster is inappropriate.</li> </ul>	<ul style="list-style-type: none"> <li>Turn off or disconnect the booster if it is in use.</li> </ul>	–
<b>No color</b> 	<ul style="list-style-type: none"> <li>The color level setting is too low.</li> </ul>	<ul style="list-style-type: none"> <li>Display the "Picture" menu and select "Personal" of "Mode", then adjust the "Color" level in "Picture Adjustment".</li> </ul>	15
	<ul style="list-style-type: none"> <li>The color system setting is inappropriate.</li> </ul>	<ul style="list-style-type: none"> <li>Display the "Setup" menu and check the "Color System" setting (usually set this to "Auto").</li> </ul>	21
	<ul style="list-style-type: none"> <li>The antenna setup is inappropriate.</li> </ul>	<ul style="list-style-type: none"> <li>Check the antenna setup. Contact a Sony dealer for advice.</li> </ul>	–

continue

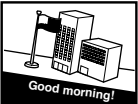
**continued**

Symptom	Possible cause	Solutions	Page
<p><b>Picture slant</b></p> 	<ul style="list-style-type: none"> <li>The magnetic disturbance from external speakers or other equipment, or the direction of the earth's magnetic field may affect the TV.</li> </ul>	<ul style="list-style-type: none"> <li>Keep external speakers or other electrical equipment away from the TV.</li> <li>Display the "Setup" menu and adjust "Picture Rotation" so that the picture position is optimal.</li> </ul>	<p>– 21</p>
<p><b>Abnormal color patches</b></p> 	<ul style="list-style-type: none"> <li>The magnetic disturbance from external speakers or other equipment, or the direction of the earth's magnetic field may affect the TV.</li> </ul>	<ul style="list-style-type: none"> <li>Keep external speakers or other equipment away from the TV. Do not move the TV while the TV is turned on. Press Ⓚ (main power) on the TV to turn off the TV for about 15 minutes, then turn it on again to demagnetize the TV.</li> </ul>	<p>–</p>
<p><b>The Ⓚ (standby) indicator on your TV flashes red several times after every three seconds.</b></p>	<ul style="list-style-type: none"> <li>Your TV's self-diagnosis function indicates the possible problems.</li> </ul>	<ul style="list-style-type: none"> <li>Count the number of times the Ⓚ (standby) indicator flashes. Press Ⓚ (main power) to turn off your TV. Contact your nearest Sony service center.</li> </ul>	<p>–</p>
<p><b>TV cabinet creaks.</b></p>	<ul style="list-style-type: none"> <li>Changes in room temperature sometimes make the TV cabinet expand or contract, causing a noise. This does not indicate a malfunction.</li> </ul>	<p>—</p>	<p>–</p>
<p><b>A small "boom" sound is heard when the TV is turned on.</b></p>	<ul style="list-style-type: none"> <li>The TV's demagnetizing function is working. This does not indicate a malfunction.</li> </ul>	<p>—</p>	<p>–</p>

# ■ Specifications

	KV-HW21M53	KV-HW21M50	Note
<b>Power requirements</b>	110-240 V AC, 50/60 Hz		
<b>Power consumption (W)</b>	Indicated on the rear of the TV		
<b>Television system</b>	B/G, I, D/K, M		
<b>Color system</b>	PAL, PAL 60, SECAM, NTSC3.58, NTSC4.43		
<b>Channel coverage</b>			
<b>B/G</b>	VHF : E2 to E12 UHF : E21 to E69 CATV : S01 to S03, S1 to S41		
<b>I</b>	UHF : B21 to B68 CATV : S01 to S03, S1 to S41		
<b>D/K</b>	VHF : C1 to C12, R1 to R12 UHF : C13 to C57, R21 to R60 CATV : S01 to S03, S1 to S41, Z1 to Z39		
<b>M</b>	VHF : A2 to A13 UHF : A14 to A79 CATV : A-8 to A-2, A to W+4, W+6 to W+84		
<b>⏏ (Antenna)</b>	75-ohm external terminal		
<b>Audio output (Speaker)</b>	3 W + 3 W	5 W + 5 W	
<b>3D Woofer</b>	9 W	—	
<b>Number of terminal</b>			
<b>📺 (Video)</b>	Input: 2      Output: 1	Phono jacks; 1 Vp-p, 75 ohms	
<b>🎧 (Audio)</b>	Input: 2      Output: 1	Phono jacks; 500 mVrms	
<b>📺 (Component Video)</b>	Input: 1	Phono jacks; Y: 1 Vp-p, 75 ohms, sync negative Cb: 0.7 Vp-p, 75 ohms Cr: 0.7 Vp-p, 75 ohms Audio: 500 mVrms	
<b>🎧 (Headphone)</b>	Output: 1	Stereo minijack	
<b>Picture tube</b>	21 in.		
<b>Tube size (cm)</b>	54		Measured diagonally
<b>Screen size (cm)</b>	51		Measured diagonally
<b>Dimensions (w/h/d, mm)</b>	630 × 470 × 492	630 × 460 × 492	
<b>Mass (kg)</b>	27	25	

Design and specifications are subject to change without notice.

<http://www.sony.net/>

Sony Corporation