

# ***Trinitron Color TV***

---

## Operating Instructions

**GB**

- Before operating the unit, please read this manual thoroughly and retain it for future reference.

**FD Trinitron**  
**WEGA**

***KV-BT21***  
***KV-BM14***

# WARNING

- Dangerously high voltages are present inside the TV.
- TV operating voltage: 110-240 V AC.
- Do not plug in the power cord until you have completed making all other connections; otherwise a minimum leakage current might flow through the antenna and other terminals to ground.
- To avoid battery leakage and damage to the remote, remove the batteries from the remote if you are not going to use it for several days. If any liquid leaks from the batteries and touches your skin, immediately wash it away with water.

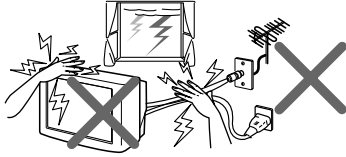

For your own safety, do not touch any part of the TV, the power cord and the antenna cable during lightning storms.



For children's safety, do not leave children alone with the TV. Do not allow children to climb onto it.

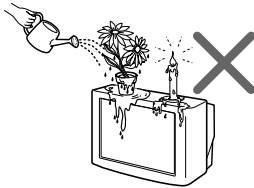

Do not place any objects on the TV. The apparatus shall not be exposed to dripping or splashing and that no objects filled with liquids, such as vases, shall be placed on the apparatus.

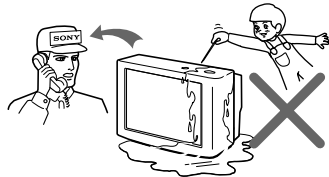

Do not operate the TV if any liquid or solid object falls into it. Have it checked immediately by qualified personnel only.

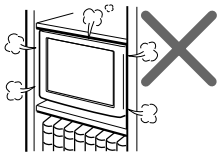

Do not block the ventilation openings of the TV. Do not install the TV in a confined space, such as a bookcase or built-in cabinet.

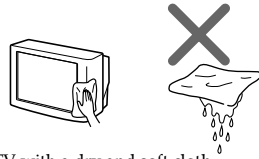

Clean the TV with a dry and soft cloth. Do not use benzine, thinner, or any other chemicals to clean the TV. Do not attach anything (e.g., adhesive tape, cellophane tape, glue) on the painted cabinet of the TV. Do not scratch the picture tube.

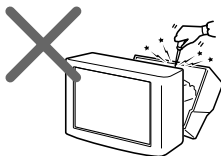

Do not open the cabinet and the rear cover of the TV as high voltages and other hazards are present inside the TV. Refer servicing and disposal of the TV to qualified personnel.

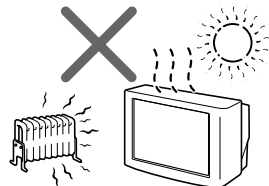

Your TV is recommended for home use only. Do not use the TV in any vehicle or where it may be subject to excessive dust, heat, moisture or vibrations.

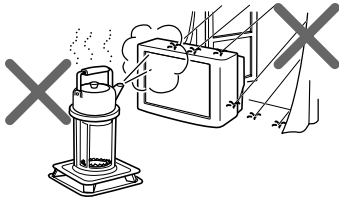

To prevent fire or shock hazard, do not expose the TV to rain or moisture.

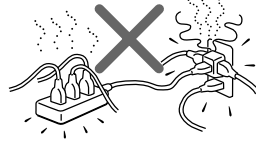

Do not plug in too many appliances to the same power socket. Do not damage the power cord.

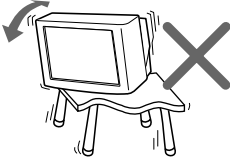

Install the TV on a stable TV stand and floor which can support the TV set weight. Ensure that the TV stand surface is flat and its area is larger than the bottom area of the TV.

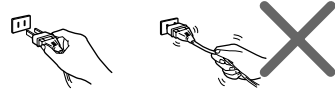

Pull the power cord out by the plug. Do not pull the power cord itself. Even if your TV is turned off, it is still connected to the AC power source (mains) as long as the power cord is plugged in. Unplug the TV before moving it or if you are not going to use it for several days.

# ■ Securing the TV

## ▶ KV-BT21N50/BT21N40 only

To prevent the TV from falling, use the supplied screws, clamps and band to secure the TV.

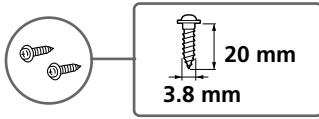

screws



clamps

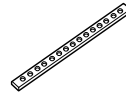

band

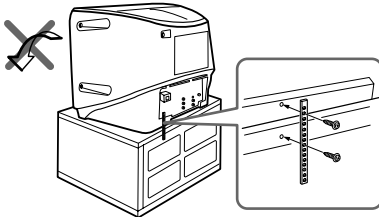

Screw the band to the TV stand and to the provided hole at the rear of your TV.

**or**

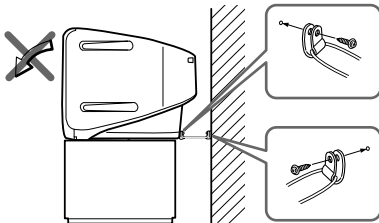

- (1) Put a cord or chain through the clamps.
- (2) Screw one clamp to a wall or pillar and the other clamp to the provided hole at the rear of your TV.

### Note

- Use only the supplied screws. Use of other screws may damage the TV.

---

# Table of Contents

---

## Installation

Getting Started .....	6
Setting up your TV ("Initial Setup") .....	7

---

## Overview of Controls

TV top control, front and rear panels .....	8
Using the remote control and basic functions .....	9

---

## Menu Adjustment

Introducing the menu system .....	11
Changing the "Video" setting .....	14
Changing the "Audio" setting .....	15
Changing the "Channel Setup" setting .....	16
Changing the "Channel Block" setting .....	17
Changing the "Timer" setting .....	18
Changing the "Setup" setting .....	19

---

## Additional Information

Connecting optional components ...	20
Troubleshooting .....	21
Specifications .....	Back cover

## ■ Getting Started

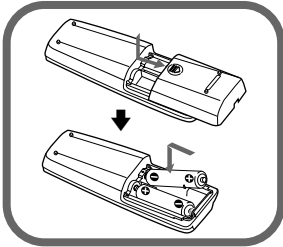

### Step 1

Insert the batteries (supplied) into the remote.

#### Note

- Do not use old or different types of batteries together.

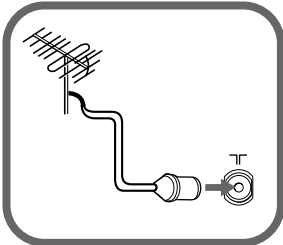

### Step 2

Connect the antenna cable (not supplied) to  $\Upsilon$  (antenna input) at the rear of the TV.

#### Tip

- You can also connect your TV to other optional components (see page 20).

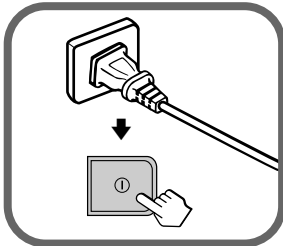

### Step 3

Plug in the power cord, then press  $\text{⏻}$  on the TV to turn it on.

#### Note

- The  $\text{⏻}$  (standby) indicator flashes green for a few seconds when turning on the TV. This does not indicate a malfunction.





### Step 4

Set up the TV by following the instructions of the "Initial Setup" menu (see page 7).

# ■ Setting up your TV ("Initial Setup")

When you turn on your TV for the first time, the "Initial Setup" menu will appear. You may change the menu language and preset the TV channels automatically using the buttons on the top control panel.

## Tip

- The MENU,  and  buttons on the remote control can also be used for the operations below.

- 1 Press VOLUME +/- to select the desired menu language, then press TV/VIDEO.

The selected menu language appears.



- 2 Press VOLUME +/- to select "Yes", then press TV/VIDEO to preset the channels automatically or select "No" to skip automatic channel presetting.

Once you select "Yes", your TV will start searching for all the available channels.

If the message "No channel found. Please connect cable/antenna." appears, check your TV connections, then press TV/VIDEO.

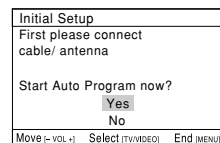

- 3 Press VOLUME +/- to select "No", then press TV/VIDEO. This menu will not appear again the next time you turn on the TV by pressing .

To allow this menu to appear again, select "Yes", then press TV/VIDEO.

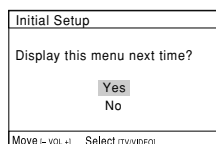

## Tips

- You can immediately go to the end of the "Initial Setup" menu by pressing MENU.
- You can also set up your TV by pressing the MENU button on the top control panel for about five seconds or using the menu system (see page 11).

## TV top control, front and rear panels

TV top control panel

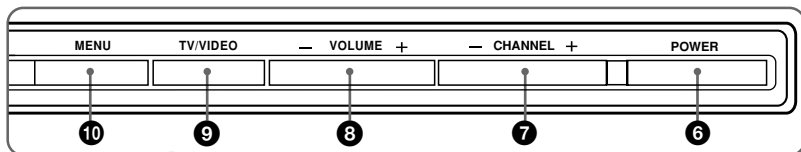

TV rear panel

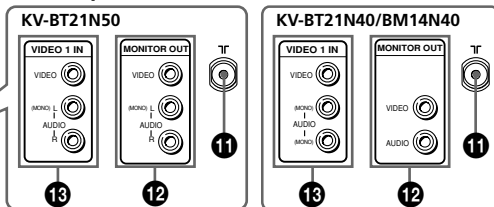
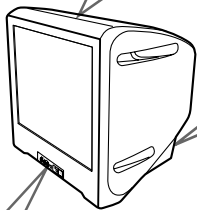

TV front panel

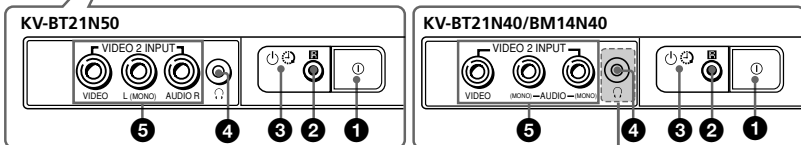

Button/Terminal	Function	Page
① ①	Turn off or turn on the TV.	6
②	Remote control sensor.	-
③	Wake Up indicator.	18
③	Standby indicator.	6
④	Headphone jack.	-
⑤ VIDEO 2 INPUT	Video input terminal 2.	20
⑥ POWER	Turn off temporarily or turn on the TV.	-
⑦ CHANNEL +/-	Select channel number.	-
⑧ VOLUME +/-	Adjust volume.	-
⑨ TV/VIDEO	Select TV or video input.	20
<b>Menu operations</b>		
⑧ VOLUME +/-	Select and adjust items.	-
⑨ TV/VIDEO	Confirm selected items.	-
⑩ MENU	Display or cancel the menu.	-
⑪	Antenna input terminal.	20
⑫ MONITOR OUT	Monitor output terminal.	20
⑬ VIDEO 1 IN	Video input terminal 1.	20

★ The earphone jack will be labeled as for KV-BM14 only.



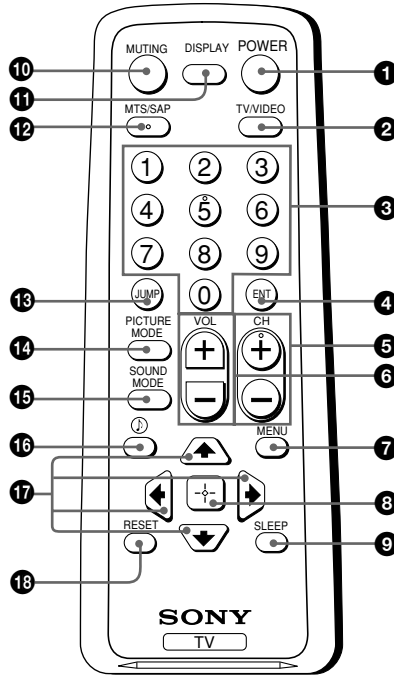

# ■ Using the remote control and basic functions



Button	Description	Page
❶ POWER	Turn off temporarily or turn on the TV.	–
❷ TV/VIDEO	Select TV or video input.	20
❸ 0–9	Input numbers.	–
❹ ENT	Confirm input numbers.	–
❺ CH +/-	Select channel number.	–
❻ VOL +/-	Adjust volume.	–
❿ MUTING	Mute the sound.	–
⓫ DISPLAY	Display on-screen information.	–
⓬ JUMP	Jump to previous channel number.	–

continue

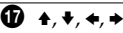

**continued**

Button	Description	Page
<b>14</b> PICTURE MODE	Select picture mode options: "Vivid" (contrast and sharp pictures), "Standard" (standard pictures), "Movie" (finely detailed pictures), "Sports" (bright pictures).	–
<b>15</b> SOUND MODE (KV-BT21N50 only)	Select sound mode options: "Movie" (low and high tones), "News" (vocals), "Soft" (soft, natural and relaxing sounds), "Standard" (standard flat sounds).	–
<b>16</b>  (KV-BT21N50 only)	Select audio effect mode options: "Effect Off", "Simulated" (stereo-like monaural sound), "Surround".	–
<b>18</b> RESET	Set TV to factory setting while adjusting items in an on-screen menu.	–
<b>Menu operations</b>		
<b>7</b> MENU	Display or cancel the menu.	13
<b>8</b> 	Confirm selected items.	13
<b>17</b> 	Select and adjust items.	13
<b>Timer operations</b>		
<b>9</b> SLEEP	Set TV to turn off automatically.	–
<b>Stereo/bilingual operations</b>		
<b>12</b> MTS/SAP	Not function for your TV.	–

## Introducing the menu system

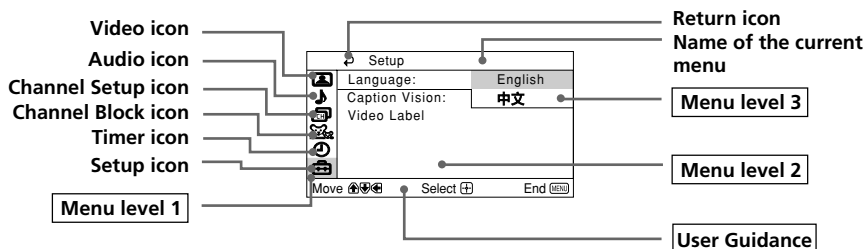



The MENU button lets you open a menu and change the settings of your TV. The following is an overview of the menu system.



Level 1	Level 2	Level 3/Function	Page
"Video" 	"Mode"	Select the picture mode: "Vivid" → "Standard" → "Movie" → "Sports"	14
	"Picture Controls"	Adjust the picture mode option: "Picture" → "Brightness" → "Color" → "Hue" → "Sharpness"	
	"Color Temp."	Adjust white color tint: "Cool" → "Neutral" → "Warm"	
	"Intelligent Picture"	Optimize picture quality: "On" → "Off"	
"Audio" 	"Mode" (KV-BT21N50 only)	Select the sound mode: "Movie" → "News" → "Soft" → "Standard"	15
	"Sound Controls" (KV-BT21N50 only)	Adjust the sound mode option: "Treble" → "Bass"	
	"Balance" (KV-BT21N50 only)	Select to emphasize the left and right speakers.	
	"Steady Sound"	Adjust volume automatically: "On" → "Off"	
	"Effect" (KV-BT21N50 only)	Select audio effect mode: "Off" → "Simulated" → "Surround"	

**continue**

**continued**

Level 1	Level 2	Level 3/Function	Page
"Channel Setup" 	"Favorite Channels"	Quick access to favorite channels.	16
	"Cable"	Watch cable TV programs: "On" → "Off"	
	"Auto Program"	Preset channels automatically.	
	"Channel Skip/ Add"	Skip unwanted channels or add new ones.	
	"Channel Label"	Label the channel number.	
"Channel Block" 	–	Block unwanted channels.	17
"Timer" 	"Sleep"	Set TV to turn off automatically.	18
	"Wake Up Timer"	Set TV to turn on automatically.	
"Setup" 	"Language"	Change the menu language: "English" → "中文" (Chinese)	19
	"Caption Vision"	Select the closed caption mode: "Off" → "CC1/2/3/4" → "Text1/2/3/4" → "Info"	
	"Video Label"	Label the connected equipment.	

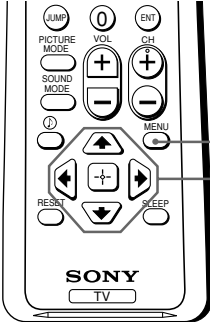

## How to use the menu



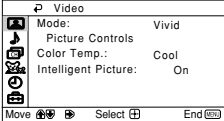

**Press MENU to display the menu.**

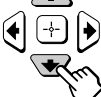
**Press  $\uparrow$  or  $\downarrow$  to select the desired item.**

**Press  $\square$  (or  $\rightarrow$ ) to confirm your selection and go to the next level.**

## Other menu operations

To	Press
Adjust the setting value	$\uparrow$ , $\downarrow$ , $\leftarrow$ or $\rightarrow$ .
Move to the next/previous menu level	$\leftarrow$ or $\rightarrow$ .
Cancel the menu	MENU.

### Tips

- If you want to exit from Menu level 2 to Menu level 1, press  $\uparrow$  or  $\downarrow$  until the return icon ( $\curvearrowright$ ) is highlighted, then press  $\square$ .
- The MENU, TV/VIDEO and VOLUME +/- buttons on the top control panel can also be used for the operations above (see page 8).



# ■ Changing the “Video” setting



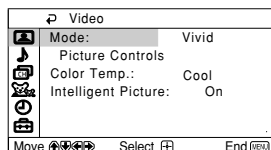

The “Video” menu allows you to adjust the picture settings.

**1** Press MENU.

**2** Make sure the “Video” icon (📺) is selected, then press .





**3** Press  or  to select the desired item (e.g., “Mode”), then press .





Select	To
“Mode”	choose either “Vivid”, “Standard”, “Movie” or “Sports” (see page 10). <b>Tip</b> <ul style="list-style-type: none"><li>You can adjust the setting to your personal preference in the “Picture Controls” option.</li></ul>
“Color Temp.” (Color Temperature)	adjust white color tint. Choose either “Cool” (blue tint), “Neutral” (neutral tint) or “Warm” (red tint).
“Intelligent Picture”	optimize picture quality. Press  or  to select “On”, then press  .To cancel, select “Off”, then press  .

## Adjusting the “Picture Controls” items

**1** Press  to select “Picture Controls”, then press .

**2** Press  or  to select either “Picture” (contrast), “Brightness”, “Color”, “Hue” (color tones) or “Sharpness”, then press .

Pressing RESET button on the remote control will set your TV to the factory setting.

**3** Press , ,  or  to adjust the setting of your selected item, then press .

**4** Repeat the above steps to adjust other items.

The adjusted settings will be memorized.

### Note

- Reducing “Sharpness” can also reduce picture noise.

# ■ Changing the “Audio” setting

The “Audio” menu allows you to adjust the sound settings.

**1** Press MENU.

**2** Press **▲** or **▼** to select the “Audio” icon (🔊), then press **⏏**.

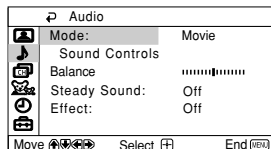

**3** Press **▲** or **▼** to select the desired item (e.g., “Mode”), then press **⏏**.

Select	To
“Mode” (KV-BT21N50 only)	choose either “Movie”, “News”, “Soft” or “Standard” (see page 10). <b>Tip</b> <ul style="list-style-type: none"><li>You can adjust the setting to your personal preference in the “Sound Controls” option.</li></ul>
“Balance” (KV-BT21N50 only)	Press <b>▼</b> or <b>◀</b> to emphasize the left speaker. Press <b>▲</b> or <b>▶</b> to emphasize the right speaker.
“Steady Sound”	adjust the volume of all channel numbers and video inputs automatically. Press <b>▲</b> or <b>▼</b> to select “On”, then press <b>⏏</b> . To cancel, select “Off”, then press <b>⏏</b> .
“Effect” (KV-BT21N50 only)	choose either “Off”, “Simulated” or “Surround” (see page 10).

## Adjusting the “Sound Controls” items (KV-BT21N50 only)

**1** Press **▼** to select “Sound Controls”, then press **⏏**.

**2** Press **▲** or **▼** to select either “Treble” or “Bass”, then press **⏏**.

Pressing RESET button on the remote control will set your TV to the factory setting.

**3** Press **▲**, **▼**, **◀** or **▶** to adjust the setting of your selected item, then press **⏏**.



**4** Repeat the above steps to adjust other items.

The adjusted settings will be memorized.

# ■ Changing the “Channel Setup” setting







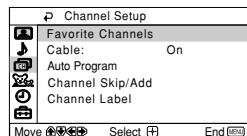



The “Channel Setup” menu allows you to quickly access favorite channels, receive cable TV programs, preset channels automatically, skip unwanted channels or add new ones and label the channel number.

**1** Press MENU.

**2** Press **↑** or **↓** to select the “Channel Setup” icon (  ), then press (  ).



**3** Press **↑** or **↓** to select the desired item (e.g., “Favorite Channels”), then press (  ).

Select	To
“Favorite Channels”	quickly access favorite channels. (1) Press <b>↑</b> or <b>↓</b> to select the position you want to set a favorite channel, then press (  ). (2) Press <b>↑</b> or <b>↓</b> to select the desired channel, then press (  ). To use “Favorite Channels”: Exit all menus and press (  ). Press <b>↑</b> or <b>↓</b> to move the cursor to the desired channel number and press (  ).
“Cable”	receive cable TV programs. Press <b>↑</b> or <b>↓</b> to select “On”, then press (  ). If you select “Cable: On”, you will be able to receive 125 cable TV channels. If there are no cable TV channels, you will receive VHF broadcast channels only. To receive only VHF and UHF broadcast channels, select “Off”, then press (  ).
“Auto Program”	preset channels automatically.
“Channel Skip/Add”	skip unwanted channels or add new ones. (1) Press <b>↑</b> or <b>↓</b> to select the desired channel, then press (  ). (2) Press <b>↑</b> or <b>↓</b> to select either “Skip” or “Add”, then press (  ).
“Channel Label”	label the channel number. (1) Select “Channel” and press (  ). Press <b>↑</b> or <b>↓</b> to select the channel number, then press (  ). (2) Select “Label” and press (  ), then press <b>↑</b> or <b>↓</b> to select alphanumeric characters for the label.

## Note

- You can skip over channels that have been skipped by pressing CH +/- . You can still use the 0-9 buttons to directly tune to skipped channels.



---

# ■ Changing the “Channel Block” setting

The “Channel Block” menu allows you to block unwanted channels.

---

**1** Press MENU.

---

**2** Press **▲** or **▼** to select the “Channel Block” icon (🔒), then press **↵**.

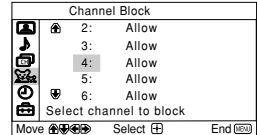

**3** Press **▲** or **▼** to select the desired channel, then press **↵**.

---

**4** Press **▲** or **▼** to select “Block” or “Allow”, then press **↵**.

---

## Notes

- When you first enter the “Channel Block” menu, the channel highlighted is the current channel that is being viewed.
- When a channel is blocked, the word “Blocked” and lock symbol (🔒) will appear on the black screen.
- “Channel Block” is disabled when in video mode.

# ■ Changing the “Timer” setting

The “Timer” menu allows you to set TV to turn off and turn on automatically.

**1** Press MENU.

**2** Press **▲** or **▼** to select the “Timer” icon (⏰), then press **↵**.

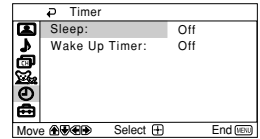

**3** Press **▲** or **▼** to select the desired item (e.g., “Sleep”), then press **↵**.

Select	To
“Sleep”	set TV to turn off automatically. Press <b>▲</b> or <b>▼</b> to select the desired period of time (max. of 90 minutes), then press <b>↵</b> .
“Wake Up Timer”	set TV to turn on automatically. Press <b>▲</b> or <b>▼</b> to select the desired period of time (max. of 12 hours), then press <b>↵</b> . After the selected length of time, the TV switches on automatically and “Wake Up Timer” will appear on the screen.  The ⏰ indicator on the TV lights up amber once you set the “Wake Up Timer”.

## Notes

- You can also cancel “Sleep” and “Wake Up Timer” by turning off the TV’s main power.
- If no buttons or controls are pressed for more than one hour after the TV is turned on using the “Wake Up Timer”, the TV automatically goes into standby mode.

# ■ Changing the “Setup” setting

The “Setup” menu allows you to change the menu language, select the closed caption mode and label the connected equipment.

**1** Press MENU.

**2** Press **▲** or **▼** to select the “Setup” icon (⏸), then press (⏸).

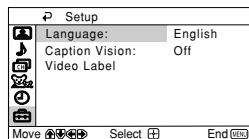

**3** Press **▲** or **▼** to select the desired item (e.g., “Language”), then press (⏸).

Select	To
“Language”	change the menu language. Press <b>▲</b> or <b>▼</b> to select either “English” or “中文” (Chinese), then press (⏸).
“Caption Vision”	select the closed caption mode. Press <b>▲</b> or <b>▼</b> to select either “Off”, “CC1/2/3/4” (printed dialogue and sound effects), “Text1/2/3/4” (network/station information) or “Info” (name of current program and remaining time).
“Video Label”	label the connected equipment. (1) Select “Video Input” and press (⏸). Press <b>▲</b> or <b>▼</b> to select the input you want to label, then press (⏸). (2) Select “Label” and press (⏸), then press <b>▲</b> or <b>▼</b> to select the label options: “Video 1/2”, “VCR”, “Cable”, “DVD” or “Customize”*. * You may customize the video label by entering alphanumeric characters.

## ■ Connecting optional components

### Connecting to VIDEO 2 INPUT and VIDEO 1 IN terminals

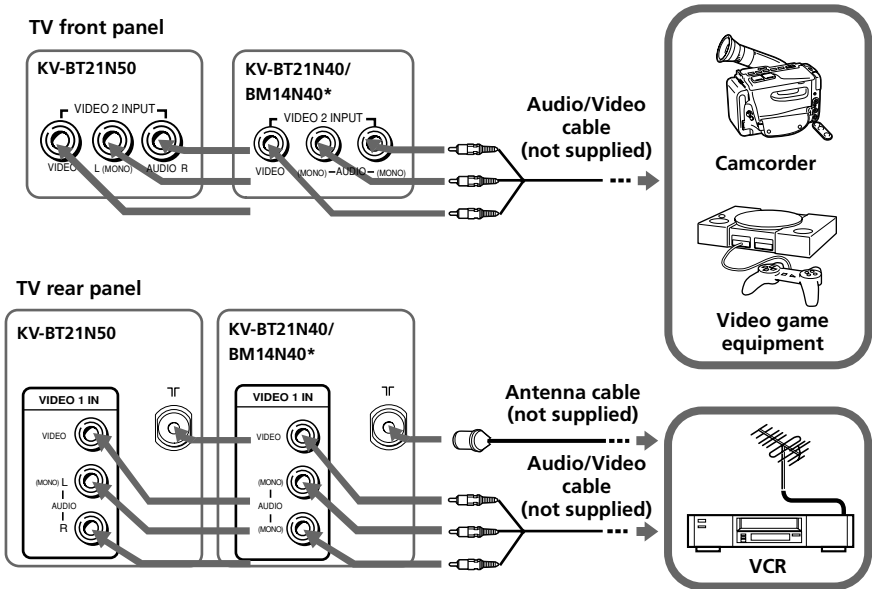

#### \* Sound Mix Terminal (KV-BT21N40/BM14N40 only)

You can connect the audio L and R jacks from your AV equipment to both AUDIO (MONO) jacks on the TV to enjoy mixed left and right sound. If you do not prefer the mixed sound, disconnect either one of the AUDIO (MONO) jacks.



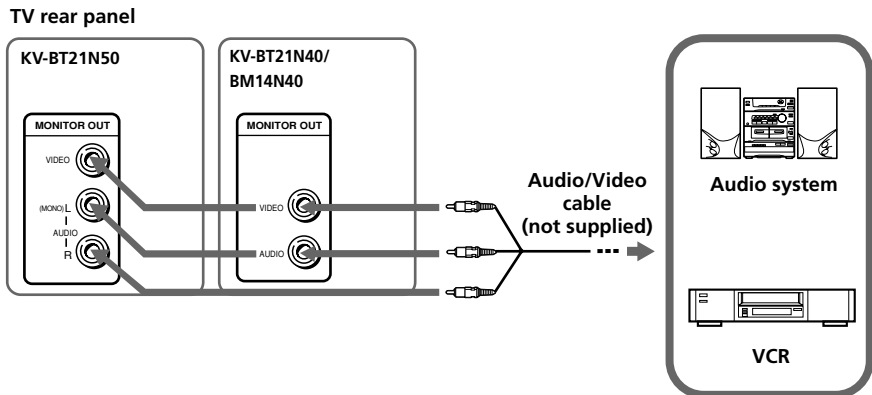





### Connecting to MONITOR OUT terminal



# Troubleshooting

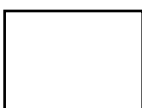



If you find any problem while viewing your TV, please check the following guide. If any problem persists, contact your Sony dealer.

## Troubleshooting guide

Symptom	Possible cause	Solutions	Page
<b>Snowy picture</b> 	<ul style="list-style-type: none"> <li>The connection is loose or the cable is damaged.</li> </ul>	<ul style="list-style-type: none"> <li>Check the antenna cable and connection on the TV, VCR and at the wall.</li> </ul>	20
	<ul style="list-style-type: none"> <li>The antenna setup is inappropriate.</li> </ul>	<ul style="list-style-type: none"> <li>Check the antenna setup. Contact a Sony dealer for advice.</li> </ul>	–
<b>Noisy sound</b> 	<ul style="list-style-type: none"> <li>Channel presetting is inappropriate or incomplete.</li> </ul>	<ul style="list-style-type: none"> <li>Preset the channel again.</li> </ul>	16
	<ul style="list-style-type: none"> <li>Signal transmission is low.</li> </ul>	<ul style="list-style-type: none"> <li>Try using a booster.</li> </ul>	–
<b>Distorted picture</b> 	<ul style="list-style-type: none"> <li>Broadcast signals are too strong.</li> </ul>	<ul style="list-style-type: none"> <li>Turn off or disconnect the booster if it is in use.</li> </ul>	–
<b>Noisy sound</b> 			
<b>No picture</b> 	<ul style="list-style-type: none"> <li>The power cord, antenna or VCR is not connected.</li> </ul>	<ul style="list-style-type: none"> <li>Check the power cord, antenna and VCR connections.</li> </ul>	20
	<ul style="list-style-type: none"> <li>The TV is not turned on.</li> </ul>	<ul style="list-style-type: none"> <li>Press POWER.</li> <li>Press  (main power) on the TV to turn off the TV for about five seconds, then turn it on again.</li> </ul>	8, 9 8
<b>No sound</b> 			
<b>Good picture</b> 	<ul style="list-style-type: none"> <li>The volume level is too low.</li> </ul>	<ul style="list-style-type: none"> <li>Press VOL + to increase the volume level.</li> </ul>	9
	<ul style="list-style-type: none"> <li>The sound is muted.</li> </ul>	<ul style="list-style-type: none"> <li>Press MUTING to cancel the muting.</li> </ul>	9
<b>No sound</b> 			

continue

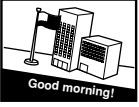
**continued**

Symptom	Possible cause	Solutions	Page
<b>Dotted lines or stripes</b> 	<ul style="list-style-type: none"> <li>• There is local interference from cars, neon signs, hair dryers, power generators, etc.</li> </ul>	<ul style="list-style-type: none"> <li>• Do not use a hair dryer or other equipment near the TV.</li> <li>• Check the antenna setup. Contact a Sony dealer for advice.</li> </ul>	<p>–</p> <p>–</p>
<b>Double images or “ghosts”</b> 	<ul style="list-style-type: none"> <li>• Broadcast signals are reflected by nearby mountains or buildings.</li> <li>• The antenna setup is inappropriate.</li> <li>• Use of a booster is inappropriate.</li> </ul>	<ul style="list-style-type: none"> <li>• Use a highly directional antenna.</li> <li>• Check the antenna setup. Contact a Sony dealer for advice.</li> <li>• Turn off or disconnect the booster if it is in use.</li> </ul>	<p>–</p> <p>–</p> <p>–</p>
<b>No color</b> 	<ul style="list-style-type: none"> <li>• The color level setting is too low.</li> <li>• The antenna setup is inappropriate.</li> </ul>	<ul style="list-style-type: none"> <li>• Display the “Video” menu and select the desired picture mode, then adjust the “Color” level in “Picture Controls”.</li> <li>• Check the antenna setup. Contact a Sony dealer for advice.</li> </ul>	<p>14</p> <p>–</p>
<b>Picture slant</b> 	<ul style="list-style-type: none"> <li>• The magnetic disturbance from external speakers or other equipment, or the direction of the earth’s magnetic field may affect the TV.</li> </ul>	<ul style="list-style-type: none"> <li>• Keep external speakers or other electrical equipment away from the TV.</li> </ul>	<p>–</p>
<b>Abnormal color patches</b> 	<ul style="list-style-type: none"> <li>• The magnetic disturbance from external speakers or other equipment, or the direction of the earth’s magnetic field may affect the TV.</li> </ul>	<ul style="list-style-type: none"> <li>• Keep external speakers or other equipment away from the TV. Do not move the TV while the TV is turned on. Press <b>⓪</b> (main power) on the TV to turn off the TV for about 15 minutes, then turn it on again to demagnetize the TV.</li> </ul>	<p>–</p>
<b>The <math>\text{⓪}</math> (standby) indicator on your TV flashes red several times after every three seconds.</b>	<ul style="list-style-type: none"> <li>• Your TV’s self-diagnosis function indicates the possible problems.</li> </ul>	<ul style="list-style-type: none"> <li>• Count the number of times the <math>\text{⓪}</math> (standby) indicator flashes. Press <b>⓪</b> (main power) to turn off your TV. Contact your nearest Sony service center.</li> </ul>	<p>–</p>

Symptom	Possible cause	Solutions	Page
<b>TV cabinet creaks.</b>	<ul style="list-style-type: none"> <li>Changes in room temperature sometimes make the TV cabinet expand or contract, causing a noise. This does not indicate a malfunction.</li> </ul>	—	—
<b>A small "boom" sound is heard when the TV is turned on.</b>	<ul style="list-style-type: none"> <li>The TV's demagnetizing function is working. This does not indicate a malfunction.</li> </ul>	—	—

# ■ Specifications

	KV-BT21N50 KV-BT21N40	KV-BM14N40	Note
<b>Power requirements</b>	110 - 240 V AC, 50/60 Hz		
<b>Power consumption (W)</b>	Indicated on the rear of the TV		
<b>Television system</b>	M		
<b>Color system</b>	NTSC3.58		
<b>Channel coverage</b>	VHF : 2 to 13 UHF : 14 to 69 CATV : 1 to 125		
<b>⌚ (Antenna)</b>	75-ohm external terminal		
<b>Audio output (Speaker)</b>	3 W + 3 W	3 W	
<b>Number of terminal</b>			
<b>VIDEO</b>	Input: 2    Output: 1	Phono jacks; 1 V <sub>p-p</sub> , 75 ohms	
<b>AUDIO</b>	Input: 2    Output: 1	Phono jacks; 500 mV <sub>rms</sub>	
<b>🎧 (Headphone)</b>	Output: 1	Stereo minijack	KV-BT21N50/ KV-BT21N40 only
<b>🎧 (Earphone)</b>	Output: 1	Monaural minijack	KV-BM14N40 only
<b>Picture tube</b>	21 in.	14 in.	
<b>Tube size</b>	545 mm	371 mm	Measured diagonally
<b>Viewing screen size</b>	507 mm	335 mm	Measured diagonally
<b>Dimensions (w/h/d)</b>	497 × 461 × 487 mm	374 × 355 × 420 mm	
<b>Mass</b>	23 kg	12 kg	

Design and specifications are subject to change without notice.

<http://www.sony.net/>

Sony Corporation