

Trinitron Color TV

Operating Instructions _____ **GB**

- Before operating the unit, please read this manual thoroughly and retain it for future reference.

使用說明書 _____ **CT**

- 使用本電視機之前請先詳細閱讀此手冊，並妥善保存以備日後用作參考。

使用说明书 _____ **CS**

- 使用本电视机之前请详细阅读此手册，并妥善保存以备日后用作参考。

FD Trinitron
WEGA

KV-AR25

WARNING

- Dangerously high voltages are present inside the TV.
- TV operating voltage: 220-240 V AC.
- Do not plug in the power cord until you have completed making all other connections; otherwise a minimum leakage current might flow through the antenna and other terminals to ground.
- To avoid battery leakage and damage to the remote, remove the batteries from the remote if you are not going to use it for several days. If any liquid leaks from the batteries and touches your skin, immediately wash it away with water.

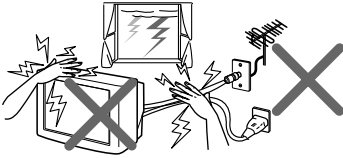

For your own safety, do not touch any part of the TV, the power cord and the antenna cable during lightning storms.



For children's safety, do not leave children alone with the TV. Do not allow children to climb onto it.

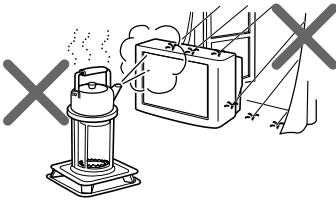

To prevent fire or shock hazard, do not expose the TV to rain or moisture.

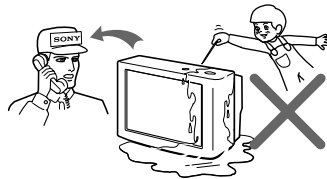

Do not operate the TV if any liquid or solid object falls into it. Have it checked immediately by qualified personnel only.

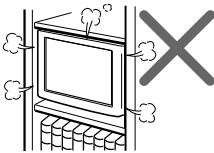

Do not block the ventilation openings of the TV. Do not install the TV in a confined space, such as a showcase or built-in cabinet.

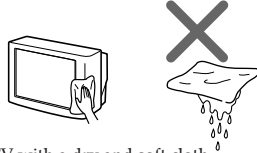

Clean the TV with a dry and soft cloth. Do not use benzine, thinner, or any other chemicals to clean the TV. Do not attach anything (e. g., adhesive tape, cellophane tape, glue) on the painted cabinet of the TV. Do not scratch the picture tube.

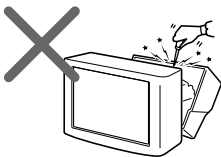

Do not open the cabinet and the rear cover of the TV as high voltages and other hazards are present inside the TV. Refer servicing and disposal of the TV to qualified personnel.

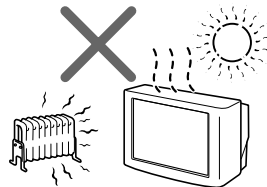

Your TV is recommended for home use only. Do not use the TV in any vehicle or where it may be subject to excessive dust, heat, moisture or vibrations.

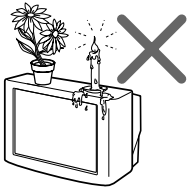

Do not place any objects on the TV.

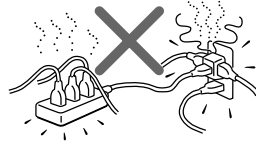

Do not plug in too many appliances to the same power socket. Do not damage the power cord.

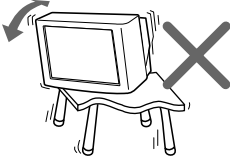

Install the TV on a stable TV stand and floor which can support the TV set weight. Ensure that the TV stand surface is flat and its area is larger than the bottom area of the TV.

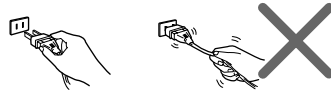

Pull the power cord out by the plug. Do not pull the power cord itself. Even if your TV is turned off, it is still connected to the AC power source (mains) as long as the power cord is plugged in. Unplug the TV before moving it or if you are not going to use it for several days.

■ Securing the TV

To prevent the TV from falling, use the supplied screws, clamps and band to secure the TV.

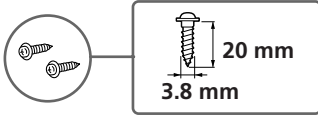

screws



clamps

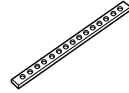

band

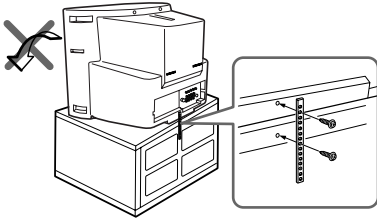

Screw the band to the TV stand and to the provided hole at the rear of your TV.

or

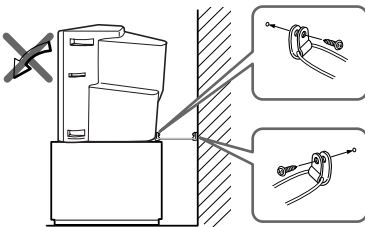

- (1) Put a cord or chain through the clamps.
- (2) Screw one clamp to a wall or pillar and the other clamp to the provided hole at the rear of your TV.

or

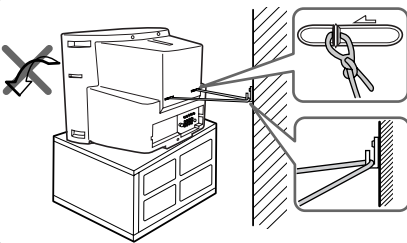

- (1) Attach each end of a cord or chain to the provided holders at the rear of your TV.
- (2) Securely fix the attached cord or chain to a wall or pillar using an attachment which can support the TV set weight.

Note

- Use only the supplied screws. Use of other screws may damage the TV.

Table of Contents

Installation

Getting Started	6
Setting up your TV ("INITIAL SETUP")	7

Overview of Controls

TV front and rear panels	8
Remote control	9

Advanced Operations

Selecting the picture and sound modes	11
Viewing the picture in wide mode ...	12
Listening with surround sound	12
Enjoying stereo or bilingual programs	13
Setting the timers	14

Menu Adjustment

Introducing the menu system	15
Changing the "PICTURE" setting ...	18
Changing the "SOUND" setting	20
Changing the "SETUP" setting	22
Changing the Channel Preset ("CH PRESET") setting	24

Additional Information

Connecting optional components ...	27
Troubleshooting	29
Specifications	Back cover

GB

■ Getting Started

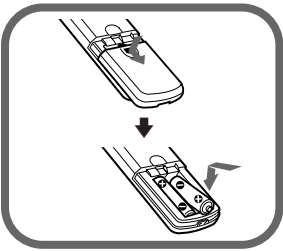

Step 1

Insert the batteries (supplied) into the remote.

Note

- Do not use old or different types of batteries together.

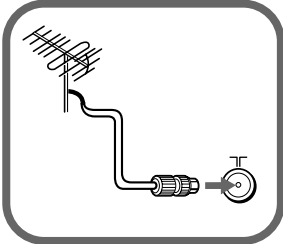

Step 2

Connect the antenna cable (not supplied) to Υ (antenna input) at the rear of the TV.

Tip

- You can also connect your TV to other optional components (see page 27).

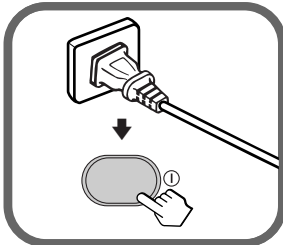

Step 3

Plug in the power cord, then press ⏻ on the TV to turn it on.

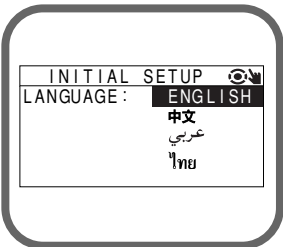

Step 4

Set up the TV by following the instructions of the "INITIAL SETUP" menu (see page 7).

■ Setting up your TV (“INITIAL SETUP”)

When you turn on your TV for the first time, the “INITIAL SETUP” menu will appear. This menu allows you to change the menu language, adjust the picture position and preset the TV channels automatically.

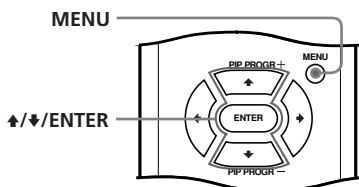

- 1 Press \uparrow or \downarrow to select the desired menu language (e.g., “ENGLISH”), then press ENTER.

The selected menu language appears.

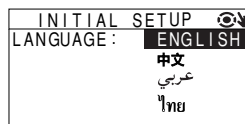

- 2 If the “PIC ROTATION” bar is slanted, press \uparrow or \downarrow to adjust it, then press ENTER.

If no adjustment is necessary, then press ENTER.

The \boxplus or \boxminus icon on the screen flashes while adjusting.

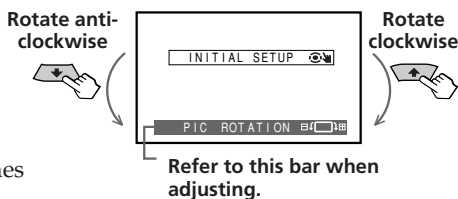

- 3 Press \uparrow or \downarrow to select “YES”, then press ENTER to preset the channels automatically (see page 24).

The screen will indicate automatic presetting is in progress.

To skip automatic channel presetting, select “NO”, then press ENTER.

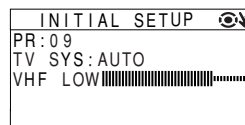
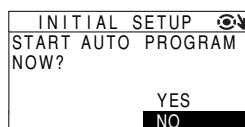

- 4 Press \uparrow or \downarrow to select “NO”, then press ENTER. The “INITIAL SETUP” menu will not appear again the next time you turn on the TV by pressing \odot .

To allow this menu to appear again, select “YES”, then press ENTER.

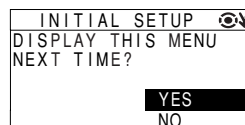

Tips

- You can immediately go to the end of the “INITIAL SETUP” menu by pressing MENU.
- You can also set up your TV using the menu system (see page 15).

TV front and rear panels

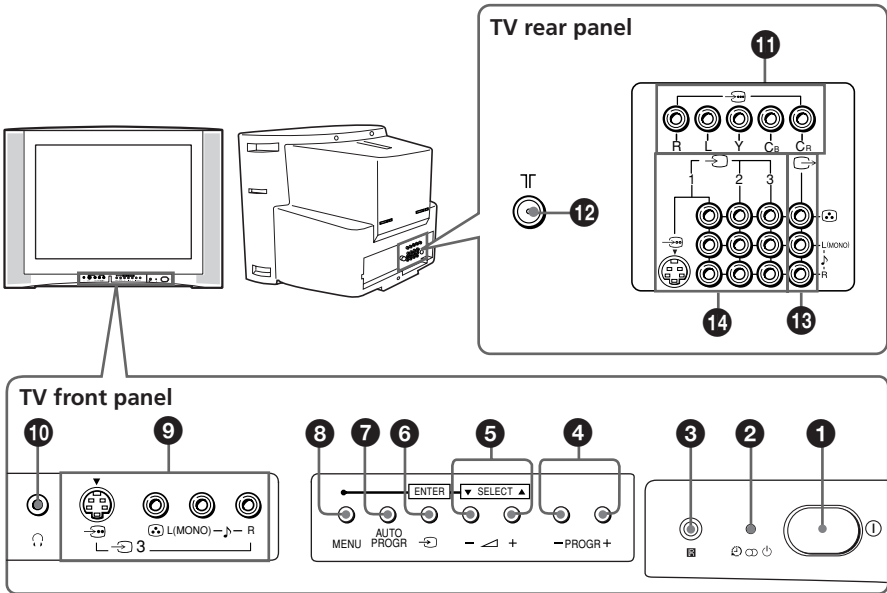

Button/Terminal	Function	Page
① ①	Turn off or turn on the TV.	6
② ⏻	Standby indicator.	–
② ⓁⓂ	Stereo/bilingual indicator.	13
② ⌚	Wake Up indicator.	14
③ Ⓜ	Remote control sensor.	–
④ PROGR +/-	Select program number.	–
⑤ ↖ +/-	Adjust volume.	–
⑥ ↵	Select TV or video input.	–
⑦ AUTO PROGR	Preset channels automatically.	–
Menu operations		
⑤ SELECT ▼/▲	Select and adjust items.	17
⑥ ENTER	Confirm selected items.	17
⑧ MENU	Display or cancel the menu.	17
⑨ ↵3	Video input terminal 3.	27
⑩ Ⓜ	Headphone jack.	–
⑪ Ⓜ	Component video input terminal.	28
⑫ Ⓜ	Antenna input terminal.	27
⑬ Ⓜ	Monitor output terminal.	27
⑭ ↵1, ↵2, ↵3	Video input terminal 1, 2, 3.	27

Remote control

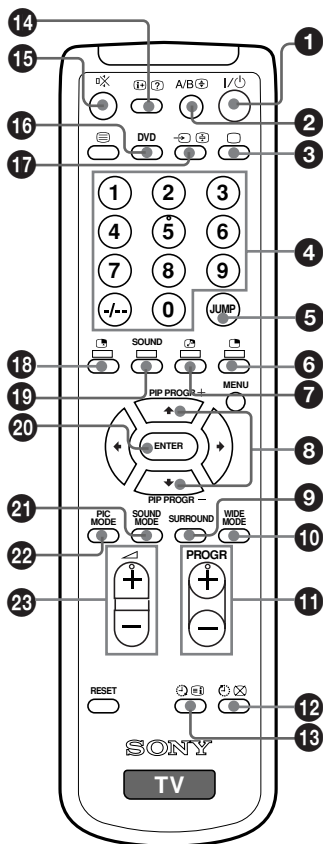

Button	Function	Page
1 I/⏻	Turn off temporarily or turn on the TV.	-
3 TV	Display the TV input.	-
4 0 - 9, +/-	Input numbers.	-
5 JUMP	Jump to previous program number.	-
9 SURROUND	Select surround mode.	12
10 WIDE MODE	Select wide-mode (16:9).	12
11 PROGR +/-	Select program number.	-
14 i+	Display on-screen information.	-
15 ⊗	Mute the sound.	-
16 DVD	Select DVD input.	28
17 TV/V	Select TV or video input.	27
21 SOUND MODE	Select sound mode.	11
22 PIC MODE	Select picture mode.	11
23 +/-	Adjust volume.	-
Timer operations		
12 ⌚	Set TV to turn off automatically.	14
13 ⌚	Set TV to turn on automatically.	14
PIP operations (yellow label)		
6 TV	Not function for your TV.	-
7 TV		
8 PIP PROGR +/-		
18 TV		
19 SOUND		
20 ENTER		
Stereo/bilingual operations		
2 A/B	Select stereo/bilingual mode.	13

continue

continued

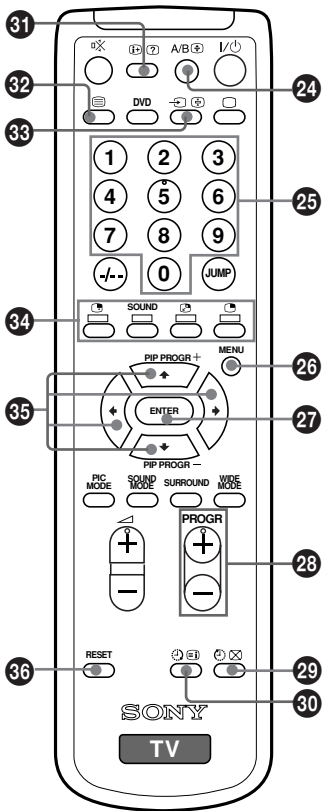

Button	Function	Page
Menu operations		
26 MENU	Display or cancel the menu.	17
27 ENTER	Confirm selected items.	17
35 ⬆, ⬇, ⬅, ➡	Select and adjust items.	17
Teletext operations (green label)		
24 Ⓜ	Not function for your TV.	-
25 0 - 9		
28 PROG +/-		
29 ⊗		
30 Ⓜ		
31 ?		
32 Ⓜ		
33 Ⓜ		
34 ■ (red, green, yellow, blue)		
36 RESET		

■ Selecting the picture and sound modes

You can select picture and sound modes and adjust the setting to your preference in the "PERSONAL" option.

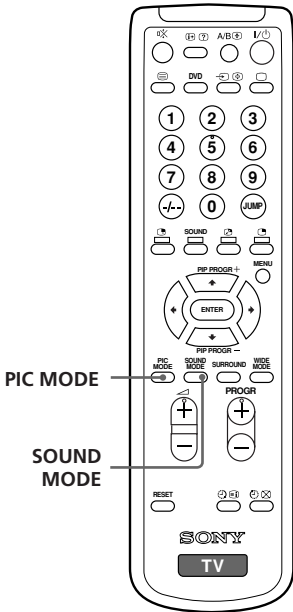





Selecting the picture mode

Press PIC MODE to select the desired picture mode.

Select	To
"DYNAMIC"	view high contrast pictures.
"STANDARD"	view normal pictures.
"SOFT"	view mild pictures.
"PERSONAL"	receive the last adjusted picture setting from the "ADJUST" option in the "PICTURE" menu (see page 19).

Selecting the sound mode

Press SOUND MODE to select the desired sound mode.

Select	To
"  DYNAMIC"	listen to dynamic and clear sound that emphasizes both the low and high tones.
"  DRAMA"	listen to sound that emphasizes voice and high tones.
"  SOFT"	listen to soft sound.
"  PERSONAL"	receive the last adjusted sound setting from the "ADJUST" option in the "SOUND" menu (see page 21).

■ Viewing the picture in wide mode

When receiving a wide-mode (16:9) signal, the picture will appear “squeezed” (compressed) on your screen. Use the WIDE MODE button to view the picture with the optimal effect.

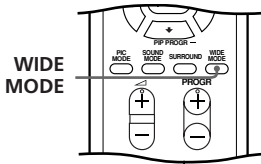

Select	To
“ON”	view the picture in wide-mode (16:9).
“OFF”	cancel wide-mode (16:9).

■ Listening with surround sound

You can use the SURROUND button to listen to the sound effects of a concert hall or movie theater.

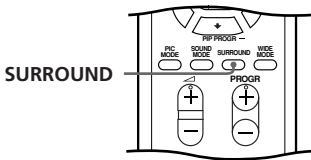

Select	To
“TruSurround”	listen to the surround sound that spreads out to the rear of a room.
“SIMULATED”	listen to monaural sound with a stereo-like effect.
“OFF”	cancel surround sound.

The surround of your TV is categorized as TruSurround.

TruSurround™ is a trademark of SRS Labs, Inc. SRS and the SRS symbol are registered trademarks of SRS Labs, Inc. in the United States and selected foreign countries. SRS and TruSurround are incorporated under license from SRS Labs, Inc. and are protected under United States Patent Nos. 4,748,669 and 4,841,572 with numerous additional issued and pending foreign patents.

■ Enjoying stereo or bilingual programs

You can enjoy stereo sound or bilingual programs of NICAM and A2 stereo systems by using the A/B button.

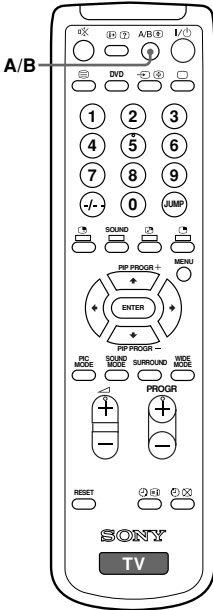

When receiving a NICAM program

Broadcasting	On-screen display (Selected sound)
NICAM stereo	NICAM (Stereo sound) → MONO (Regular sound)
NICAM bilingual	NICAM MAIN (Main sound) → NICAM SUB (Sub sound) → MONO (Regular sound)
NICAM monaural	NICAM MAIN (Main sound) → MONO (Regular sound)

When receiving an A2 program

Broadcasting	On-screen display (Selected sound)
A2 stereo	STEREO (Stereo sound) → MONO (Regular sound)
A2 bilingual	MAIN (Main sound) → SUB (Sub sound)

Notes

- If the stereo sound is noisy when receiving a stereo program, select "MONO". The sound becomes monaural, but the noise is reduced.
- Before receiving a NICAM stereo program in China, please check the NICAM broadcast condition in your area. When receiving a NICAM stereo program, the receiving conditions might vary depending on area. In addition, different strength of the NICAM broadcast signal might affect the receiving quality.
- If the sound is distorted when receiving a monaural program through ㊦ (antenna input), press A/B repeatedly until "MONO" appears on the screen. To cancel the monaural sound setting, press A/B again until "AUTO" appears on the screen.

Setting the timers

You can set your TV to turn on and off automatically by using the WAKE UP and SLEEP timers respectively.

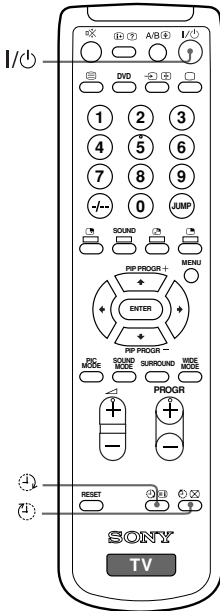

Setting the Wake Up timer

- 1 Press until the desired period of time appears on the screen.

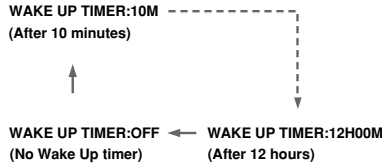

The Wake Up timer starts immediately after you have set it.

- 2 Select the program number or video input you want to wake up to.

- 3 Press I/Power, or set the Sleep timer if you want the TV to turn off automatically.

The indicator on the TV lights up orange when the TV goes into standby mode.

Setting the Sleep timer

Press until the desired period of time appears on the screen.

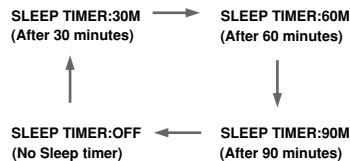

The Sleep timer starts immediately after you have set it.



Notes

- You can also cancel the Wake Up and Sleep timers by pressing on the TV to turn off the TV.
- If no buttons are pressed for more than two hours after the TV is turned on using the Wake Up timer, the TV automatically goes into standby mode.

Introducing the menu system

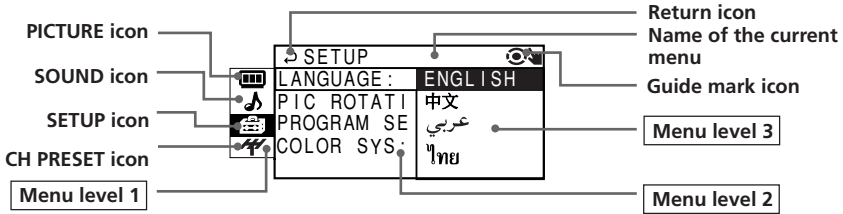

The MENU button lets you open a menu and change the settings of your TV. The following is an overview of the menu system.



Level 1	Level 2	Level 3/Function	Page
"PICTURE" 	"PICTURE MODE"	Select the picture mode: "DYNAMIC" → "STANDARD" → "SOFT" → "PERSONAL" → "ADJUST"	18
	"ADJUST"	Adjust the "PERSONAL" option: "PICTURE" → "COLOR" → "BRIGHT" → "HUE" → "SHARP"	
	"WIDE MODE"	Change the picture size: "ON" → "OFF"	
	"INTELLIGENT PIC"	Optimize picture quality: "ON" → "OFF"	
"SOUND" 	"SOUND MODE"	Select the sound mode: "DYNAMIC" → "DRAMA" → "SOFT" → "PERSONAL" → "ADJUST"	20
	"ADJUST"	Adjust the "PERSONAL" option: "BASS" → "TREBLE" → "BALANCE" → "BBE"*	
	"SURROUND"	Select the "SURROUND" mode: "TruSurround" → "SIMULATED" → "OFF"	
	"INTELLIGENT VOL"	Adjust volume automatically: "ON" → "OFF"	

continue

continued

Level 1	Level 2	Level 3/Function	Page
"SETUP" 	"LANGUAGE"	Change the menu language: "ENGLISH" → "中文"(Chinese) → "عربي"(Arabic) → "ไทย"(Thai)	22
	"PIC ROTATION"	Adjust the picture position.	
	"PROGRAM SETUP"	Adjust each program number settings.	
	"COLOR SYS"	Select the color system: "AUTO" → "PAL" → "SECAM" → "NTSC3.58" → "NTSC4.43"	
"CH PRESET" 	"AUTO PROGRAM"	Preset channels automatically.	24
	"MANUAL PROGRAM"	Preset channels manually.	
	"TV SYS"	Select the TV system: "B/G" → "I" → "D/K" → "M"	

* The BBE is manufactured by Sony Corporation under license from BBE Sound, Inc. It is covered by U.S. Patent No. 4,638,258 and No. 4,482,866. The word "BBE" and the BBE symbol are the trademarks of BBE Sound, Inc.

How to use the menu

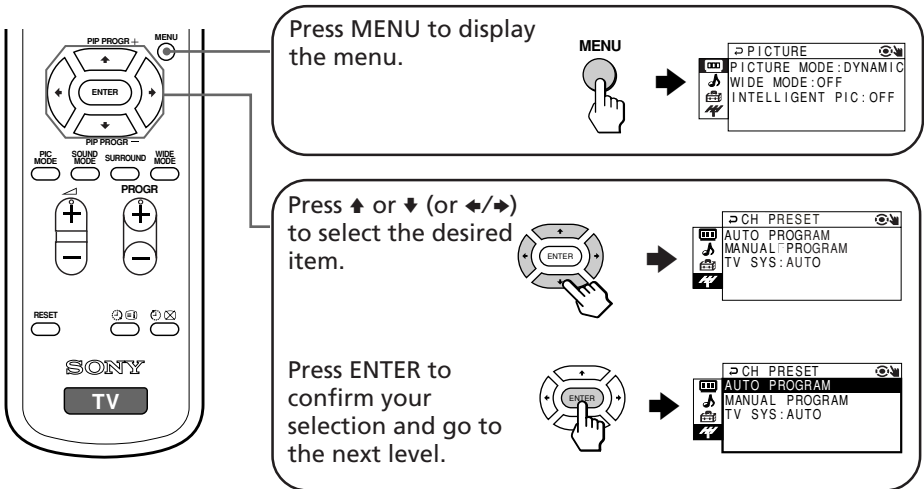

Other menu operations

To	Press
Adjust the setting value	$\uparrow, \downarrow, \leftarrow$ or \rightarrow .
Move to the next/previous menu level	\leftarrow or \rightarrow .
Cancel the menu	MENU.

Tips

- If you want to exit from Menu level 2 to Menu level 1, press \uparrow or \downarrow until the return icon (\curvearrowright) is highlighted, then press ENTER.
- Some of the menu items can be operated directly using the remote buttons.
- The MENU, ENTER, and SELECT ∇/\blacktriangle buttons on the TV can also be used for the operations above.

Front of TV

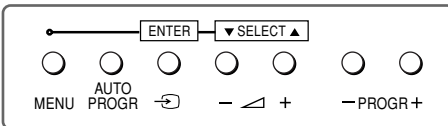

■ Changing the “PICTURE” setting

The “PICTURE” menu allows you to adjust the picture settings.

1 Press MENU.

2 Make sure the “PICTURE” icon (🖼️) is selected, then press ENTER.

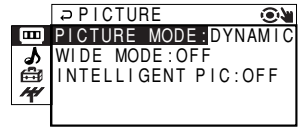

3 Press **↑** or **↓** to select the desired item (e.g., “PICTURE MODE”), then press ENTER.

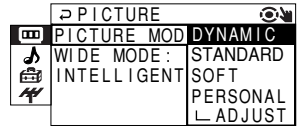

Select	To
“PICTURE MODE”	choose either “DYNAMIC”, “STANDARD”, “SOFT”, “PERSONAL”*, or “ADJUST” (see page 11).
“WIDE MODE”	choose either “ON” or “OFF” (see page 12).
“INTELLIGENT PIC”	optimize picture quality. Press ↑ or ↓ to select “ON”, then press ENTER. To cancel, select “OFF”, then press ENTER.

* When the “PERSONAL” mode is selected, you can receive the last adjusted picture settings from the “ADJUST” option (see page 19).

■ Changing the “SOUND” setting

The “SOUND” menu allows you to adjust the sound settings.

1 Press MENU.

2 Press **↑** or **↓** to select the “SOUND” icon (🔊), then press ENTER.

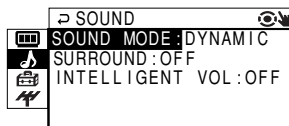

3 Press **↑** or **↓** to select the desired item (e.g., “SOUND MODE”), then press ENTER.

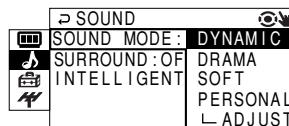

Select	To
“SOUND MODE”	choose either “DYNAMIC”, “DRAMA”, “SOFT”, “PERSONAL”*, or “ADJUST” (see page 11).
“SURROUND”	choose either “TruSurround”, “SIMULATED” or “OFF” (see page 12).
“INTELLIGENT VOL”	adjust the volume of all program numbers and video inputs automatically. Press ↑ or ↓ to select “ON”, then press ENTER. To cancel, select “OFF”, then press ENTER.

* When the “PERSONAL” mode is selected, you can receive the last adjusted sound settings from the “ADJUST” option (see page 21).

Adjusting the "ADJUST" items under "SOUND MODE"

- 1** Press **↑** or **↓** to select the desired item (e.g., "BALANCE"), then press ENTER.



BALANCE  00

- 2** Adjust the value according to the following table, then press ENTER .

For	Press ↓ or ← to	Press ↑ or → to
"BASS"	decrease the bass.	increase the bass.
"TREBLE"	decrease the treble.	increase the treble.
"BALANCE"	increase the left speaker's volume.	increase the right speaker's volume.
"BBE"	select "HIGH" for higher enhancement of sound clarity; select "LOW" for lower enhancement of sound clarity; select "OFF" to cancel BBE sound.	

- 3** Repeat the above steps to adjust other items.
The adjusted settings will be received when you select "PERSONAL".
-

■ Changing the “SETUP” setting

The “SETUP” menu allows you to change the menu language, adjust the picture position, set up your program numbers and select the color system.

1 Press MENU.

2 Press **↑** or **↓** to select the “SETUP” icon (📺), then press ENTER.

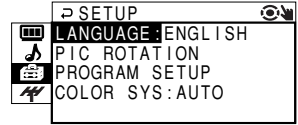

3 Press **↑** or **↓** to select the desired item (e.g., “COLOR SYS”), then press ENTER.

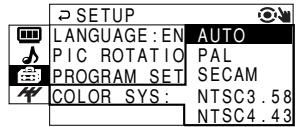

Select	To
“LANGUAGE”	<p>change the menu language.</p> <p>Press ↑ or ↓ to select either “ENGLISH”, “中文” (Chinese), “عربي” (Arabic), or “ไทย” (Thai), then press ENTER.</p> <p>The selected menu language appears.</p>
“PIC ROTATION”	<p>adjust the picture position when it is not aligned with the TV screen.</p> <p>Press ↑, →, ↓ or ← to adjust the picture position, then press ENTER.</p> <div style="border: 1px solid black; padding: 5px; margin: 10px auto; width: fit-content;"> <p>PIC ROTATION 📺</p> </div>
“PROGRAM SETUP”	<p>adjust each channel settings (see Adjusting each program number settings (“PROGRAM SETUP”) on page 23).</p>
“COLOR SYS”	<p>select the color system. Normally, set this to “AUTO”.</p>

Adjusting each program number settings (“PROGRAM SETUP”)

1 Select “PROGRAM SETUP” from the “SETUP” menu.

2 Select “PR” and press ENTER. Press \uparrow or \downarrow to select the desired program number you want to adjust, then press ENTER.

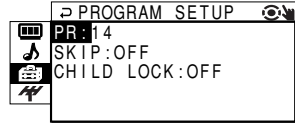

3 Press \uparrow or \downarrow to select the desired item (e.g., “SKIP”), then press ENTER.

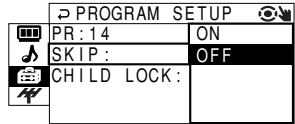

Select	To
“PR”	select the desired program number.
“SKIP”	skip unwanted or unused program number. Press \uparrow or \downarrow to select “ON”, then press ENTER. To cancel, select “OFF”, then press ENTER.
“CHILD LOCK”	prevent children from watching this selected program number. Press \uparrow or \downarrow to select “ON”, then press ENTER. The lock symbol () appears on the screen. To cancel, select “OFF”, then press ENTER. If you preset a locked program number, that program number will be unlocked automatically.

4 To continue adjusting other program numbers, press \uparrow or \downarrow to select “PR”, then repeat step 2 and 3.

■ Changing the Channel Preset (“CH PRESET”) setting

The “CH PRESET” menu allows you to preset channels automatically, manually preset channels and select the TV system.

1 Press MENU.

2 Press **▲** or **▼** to select the “CH PRESET” icon () , then press ENTER.

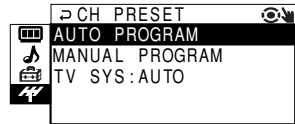

3 Press **▲** or **▼** to select the desired item (e.g., “AUTO PROGRAM”), then press ENTER.

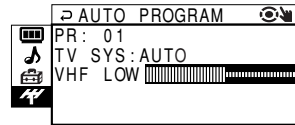

Select	To
“AUTO PROGRAM”	preset channels automatically.
“MANUAL PROGRAM”	manually preset desired channels and channels that cannot be preset automatically (see Presetting channels manually on page 25).
“TV SYS”	select the TV system. Press ▲ or ▼ to select either “B/G”, “I”, “D/K” or “M”, then press ENTER.

Presetting channels manually

1 After selecting “MANUAL PROGRAM”, select the program number to which you want to preset a channel.

- (1) Make sure “PR” is selected, then press ENTER.
- (2) Press \uparrow or \downarrow until the program number you want to preset (e.g., program number “10”) appears on the menu, then press ENTER.

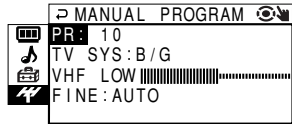
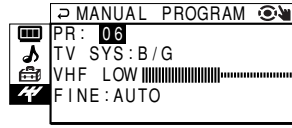

2 Select the desired channel.

- (1) Make sure either “VHF LOW”, “VHF HIGH”, or “UHF” is selected, then press ENTER.
- (2) Press \uparrow or \downarrow until the desired channel’s broadcast appears on the TV screen, then press ENTER.

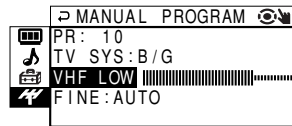
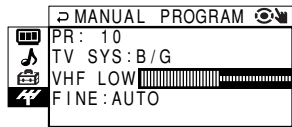

3 If the sound of the desired channel is abnormal, select the appropriate TV system.

- (1) Press \uparrow or \downarrow to select “TV SYS”, then press ENTER.
- (2) Press \uparrow or \downarrow until the sound becomes normal, then press ENTER.

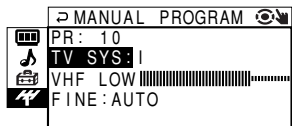
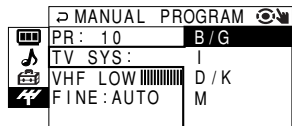

Tip

- You can also select the program number with the PROGR +/- or number buttons.

continue

continued

4 If you are not satisfied with the picture and sound quality, you may be able to improve them by using the “FINE” tuning feature.

(1) Press **▲** or **▼** to select “FINE”, then press ENTER.

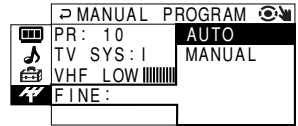

(2) Press **▲** or **▼** to select “MANUAL”, then press ENTER.

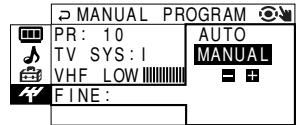

(3) Press **▲**, **▼**, **◀** or **▶** until the picture and sound quality are optimal, then press ENTER.
The + or – icon on the menu flashes while tuning.

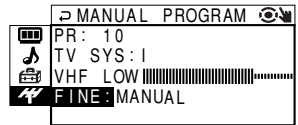

Note

- If you connect a VCR to **㊦** (antenna input), preset the signal output from the VCR to the program number 0 on the TV.

■ Connecting optional components

Connecting to the video input terminal (⇨)

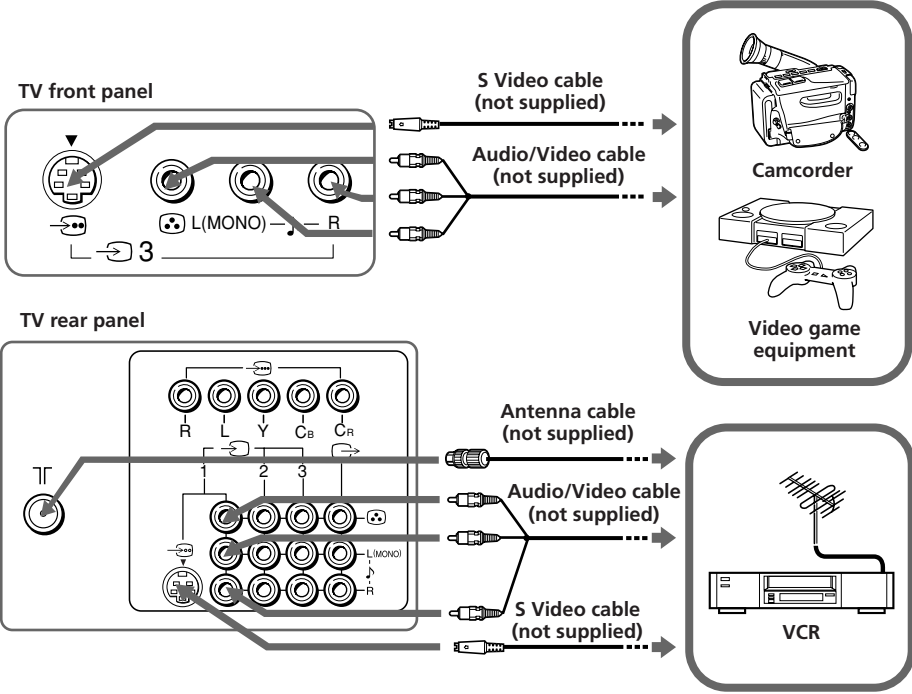

Connecting to the monitor output terminal (⇨)

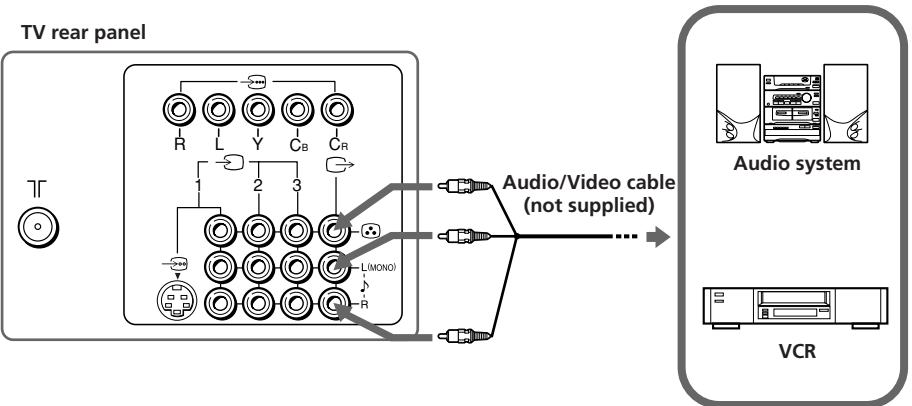

continue

continued

Connecting a DVD player to the component video input terminal ()

- 1 Using an audio cable, connect R and L under () (component video input) on your TV to the LINE OUT, AUDIO R and L output connectors on your DVD player.
- 2 Using a component video cable, connect Y, C_B, and C_R under () (component video input) on your TV to the COMPONENT VIDEO OUT Y, C_B, and C_R output connectors on your DVD player.
- 3 Press DVD on the remote to watch the () (component video input) and "DVD" will appear on your screen.

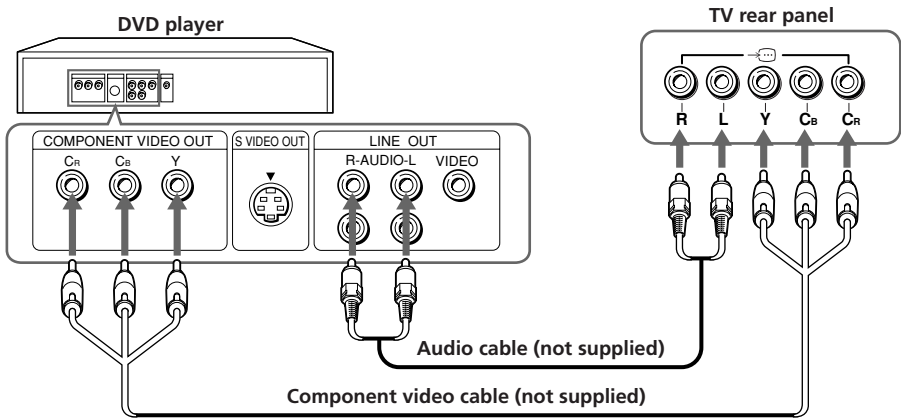

Notes

- If your DVD player can output interlace and progressive mode signals, select the interlace output when connecting to () (component video input) on your TV. Your TV can receive either 525i/60Hz or 625i/50Hz interlace signals.
- Some DVD player terminals may be labeled differently:

Connect	To (on the DVD player)
Y (green)	Y
C _B (blue)	C _B , P _B , C _b or B-Y
C _R (red)	C _R , P _R , C _r or R-Y

- When both () (S video) and () (video) for () 1 or () 3 are connected at the same time, () (S video) is automatically selected. To view () (video), disconnect the S video cable.
- If you select "DVD" on your TV screen, the signal from the () (monitor output) jacks will not be output properly. This does not indicate a malfunction.

Troubleshooting

If you have any problem while viewing your TV, you can either use the Reset function or check the Troubleshooting guide below. If the problem persists, contact your Sony dealer.

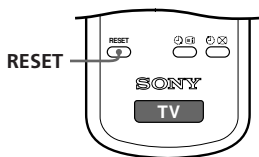

Reset function

Press the RESET button on your remote control. Your TV will go blank for about half a second then the picture will reappear with "RESET" displayed on your TV screen for about 10 seconds.







Pressing RESET will set your TV to the factory setting, but certain problems may be solved.



Troubleshooting guide

Symptom	Possible cause	Solutions	Page
Snowy picture 	<ul style="list-style-type: none"> The connection is loose or the cable is damaged. The antenna setup is inappropriate. 	<ul style="list-style-type: none"> Check the antenna cable and connection on the TV, VCR and at the wall. Check the antenna setup. Contact a Sony dealer for advice. 	27 -
Noisy sound 	<ul style="list-style-type: none"> Channel presetting is inappropriate or incomplete. Signal transmission is low. 	<ul style="list-style-type: none"> Display the "CH PRESET" menu and select "MANUAL PROGRAM" to preset the channel again. Try using a booster. 	25 -
Distorted picture 	<ul style="list-style-type: none"> Broadcast signals are too strong. 	<ul style="list-style-type: none"> Turn off or disconnect the booster if it is in use. 	-
Noisy sound 			
Good picture 	<ul style="list-style-type: none"> The TV system setting is inappropriate. 	<ul style="list-style-type: none"> Display the "CH PRESET" menu and select the appropriate TV system ("TV SYS"). 	25
Noisy sound 			

continue

continued

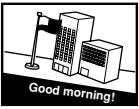
Symptom	Possible cause	Solutions	Page
No picture 	<ul style="list-style-type: none"> The power cord, antenna or VCR is not connected. 	<ul style="list-style-type: none"> Check the power cord, antenna and VCR connections. 	27
No sound 	<ul style="list-style-type: none"> The TV is not turned on. 	<ul style="list-style-type: none"> Press I/⏻ (power). Press Ⓚ (main power) on the TV to turn off the TV for about five seconds, then turn it on again. 	9 8
Good picture 	<ul style="list-style-type: none"> The volume level is too low. 	<ul style="list-style-type: none"> Press ▲ + to increase the volume level. 	9
No sound 	<ul style="list-style-type: none"> The sound is muted. 	<ul style="list-style-type: none"> Press ⓧ to cancel the muting. 	9
Dotted lines or stripes 	<ul style="list-style-type: none"> There is local interference from cars, neon signs, hair dryers, power generators, etc. 	<ul style="list-style-type: none"> Do not use a hair dryer or other equipment near the TV. Check the antenna setup. Contact a Sony dealer for advice. 	– –
Double images or "ghosts" 	<ul style="list-style-type: none"> Broadcast signals are reflected by nearby mountains or buildings. 	<ul style="list-style-type: none"> Use a highly directional antenna. Use the fine tuning ("FINE") function. 	– 26
	<ul style="list-style-type: none"> The antenna setup is inappropriate. 	<ul style="list-style-type: none"> Check the antenna setup. Contact a Sony dealer for advice. 	–
	<ul style="list-style-type: none"> Use of a booster is inappropriate. 	<ul style="list-style-type: none"> Turn off or disconnect the booster if it is in use. 	–
No color 	<ul style="list-style-type: none"> The color level setting is too low. 	<ul style="list-style-type: none"> Display the "PICTURE" menu and select "ADJUST" of "PICTURE MODE", then adjust the "COLOR" level. 	19
	<ul style="list-style-type: none"> The color system setting is inappropriate. 	<ul style="list-style-type: none"> Display the "SETUP" menu and check the color system ("COLOR SYS") setting (usually set this to "AUTO"). 	22
	<ul style="list-style-type: none"> The antenna setup is inappropriate. 	<ul style="list-style-type: none"> Check the antenna setup. Contact a Sony dealer for advice. 	–

Symptom	Possible cause	Solutions	Page
Picture slant 	<ul style="list-style-type: none"> The magnetic disturbance from external speakers or other equipment, or the direction of the earth's magnetic field may affect the TV. 	<ul style="list-style-type: none"> Keep external speakers or other electrical equipment away from the TV. Display the "SETUP" menu and adjust "PIC ROTATION" so that the picture position is optimal. 	<p>–</p> <p>22</p>
Abnormal color patches 	<ul style="list-style-type: none"> The magnetic disturbance from external speakers or other equipment, or the direction of the earth's magnetic field may affect the TV. 	<ul style="list-style-type: none"> Keep external speakers or other equipment away from the TV. Do not move the TV while the TV is turned on. Press Ⓜ (main power) on the TV to turn off the TV for about 15 minutes, then turn it on again to demagnetize the TV. 	–
TV cannot receive stereo broadcast sound. Or	<ul style="list-style-type: none"> The stereo reception setting is inappropriate. 	<ul style="list-style-type: none"> Press A/B until "AUTO" appears on the screen. 	13
Stereo broadcast sound switches on and off or is distorted.	<ul style="list-style-type: none"> The connection is loose or the cable is damaged. 	<ul style="list-style-type: none"> Check the antenna cable and connection on the TV, VCR and on the wall. 	27
The Ⓜ (standby) indicator on your TV flashes red several times after every three seconds.	<ul style="list-style-type: none"> The antenna setup is inappropriate. 	<ul style="list-style-type: none"> Check the antenna setup. Contact a Sony dealer for advice. 	–
The Ⓜ (standby) indicator on your TV flashes red several times after every three seconds.	<ul style="list-style-type: none"> Your TV's self-diagnosis function indicates the possible problems. 	<ul style="list-style-type: none"> Count the number of times the Ⓜ (standby) indicator flashes. Press Ⓜ (main power) to turn off your TV. Contact your nearest Sony service center. 	–
Cannot play shooting game.	<ul style="list-style-type: none"> Some shooting games which involve pointing a light beam at the TV screen with an electronic gun or rifle cannot be used with your TV. For details, see the instruction manual supplied with the video game software. 	–	–
TV cabinet creaks.	<ul style="list-style-type: none"> Changes in room temperature sometimes make the TV cabinet expand or contract, causing a noise. This does not indicate a malfunction. 	–	–
A small "boom" sound is heard when the TV is turned on.	<ul style="list-style-type: none"> The TV's demagnetizing function is working. This does not indicate a malfunction. 	–	–

Specifications

	KV-AR25M90	Note
Power requirements	220-240 V AC, 50/60 Hz	
Power consumption (W)	Indicated on the rear of the TV	
Television system	B/G, I, D/K, M	
Color system	PAL, PAL 60, SECAM, NTSC3.58, NTSC4.43	
Stereo/Bilingual system	NICAM Stereo/Bilingual B/G, I; A2 Stereo/Bilingual B/G	
Channel coverage		
B/G	VHF : E2 to E12 UHF : E21 to E69 CATV: S01 to S03, S1 to S41	
I	UHF : B21 to B68 CATV: S01 to S03, S1 to S41	
D/K	VHF : C1 to C12, R1 to R12 UHF : C13 to C57, R21 to R60 CATV: S01 to S03, S1 to S41, Z1 to Z39	
M	VHF : A2 to A13 UHF : A14 to A79 CATV: A-8 to A-2, A to W+4, W+6 to W+84	
⌚ (Antenna)	75-ohm external terminal	
Audio output (Speaker)	8W + 8W	
Number of terminal		
🎥 (Video)	Input: 4* Output: 1 Phono jacks; 1 Vp-p, 75 ohms	* Three input lines available
🎵 (Audio)	Input: 4* Output: 1 Phono jacks; 500 mVrms	* Three input lines available
📺 (S Video)	Input: 2 Y: 1 Vp-p, 75 ohms, unbalanced, sync negative C: 0.286 Vp-p, 75 ohms	
📺 (Component Video)	Input: 1 Phono jacks; Y: 1 Vp-p, 75 ohms, sync negative Cb: 0.7 Vp-p, 75 ohms Cr: 0.7 Vp-p, 75 ohms Audio: 500 mVrms	
🎧 (Headphone)	Output: 1 Stereo minijack	
Picture tube	25 in.	
Tube size (cm)	64	Measured diagonally
Screen size (cm)	60	Measured diagonally
Dimensions (w/h/d, mm)	650 × 517 × 496	
Mass (kg)	39	

Design and specifications are subject to change without notice.