

Trinitron[®] Color TV

Operating Instructions



KV-EX34
KV-EX29

WARNING

- Dangerously high voltages are present inside the TV.
- TV operating voltage: 220 V AC.

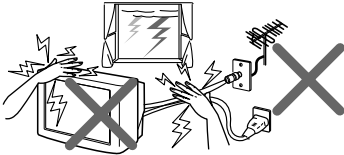

For your own safety, do not touch any part of the TV, the power cord and the antenna cable during lightning storms.



For children's safety, do not leave children alone with the TV. Do not allow children to climb onto it.

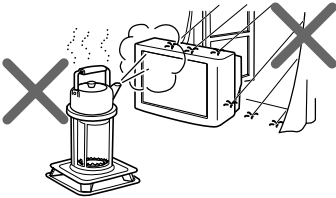

To prevent fire or shock hazard, do not expose the TV to rain or moisture.

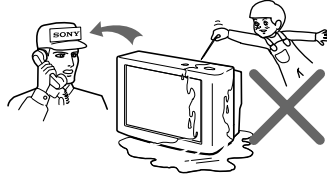

Do not operate the TV if any liquid or solid object falls into it. Have it checked immediately by qualified personnel only.

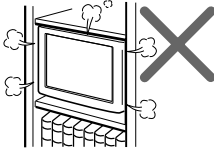

Do not block the ventilation openings of the TV. Do not install the TV in a confined space, such as a bookcase or built-in cabinet.

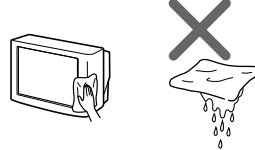

Clean the TV with a dry and soft cloth. Do not use benzene, thinner, or any other chemicals to clean the TV. Do not scratch the picture tube.

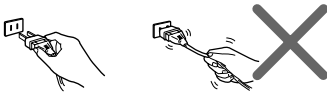

Pull the power cord out by the plug. Do not pull the power cord itself. Disconnect the TV before moving it or if you are not going to use it for several days.

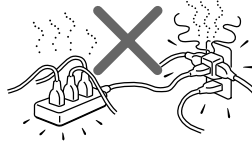

Do not plug in too many appliances to the same power socket. Do not damage the power cord.

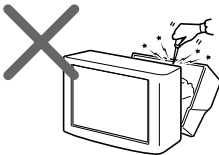

Do not open the cabinet and the rear cover of the TV as high voltages and other hazards are present inside the TV. Refer servicing and disposal of the TV to qualified personnel.

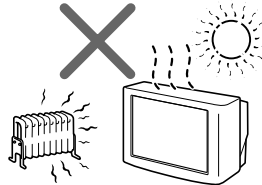

Your TV is recommended for home use only. Do not use the TV in any vehicle or where it may be subject to excessive dust, heat, moisture or vibrations.

Table of Contents

Using Your New TV



Getting Started	4
Step 1: Connect the antenna	4
Step 2: Insert the batteries into the remote	5
Step 3: Preset the channels automatically	5
Connecting the 3D WOOFER	6
Connecting optional components	7
Securing the TV	10
Watching the TV	11

Advanced Operations

Selecting the picture and sound modes	15
Viewing higher quality pictures	16
Viewing your favorite channels	17
Listening with surround sound	18
Enjoying stereo or bilingual programs (KV-EX34M93 only)	19

Adjusting Your Setup (MENU)

Introducing the menu system	21
Changing the "PICTURE" setting  ..	24

Changing the "SOUND" setting 	26
Changing the "SETUP" setting  ...	28
Changing the channel preset ("CH PRESET") setting 	30

Additional Information

Self-diagnosis function	33
Troubleshooting	34
Overview of controls	38
Specifications	Back cover

WARNING (continued)

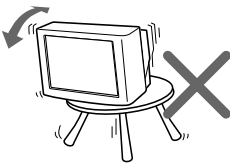

Do not install the TV in an unstable position.
Use a proper TV stand.

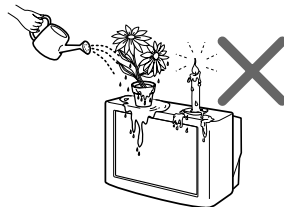

Do not place any objects on the TV.

Getting Started

CAUTION

- Do not connect the power cord until you have completed making all other connections; otherwise a minimum leakage current might flow through the antenna and other terminals to ground.
- To avoid battery leakage and damage to the remote, remove the batteries from the remote if you are not going to use it for several days. If any liquid that leaks from the batteries touches you, immediately wash it away with water.

Step 1

Connect the antenna

If you wish to connect a VCR, see the **Connecting a VCR** diagram below.

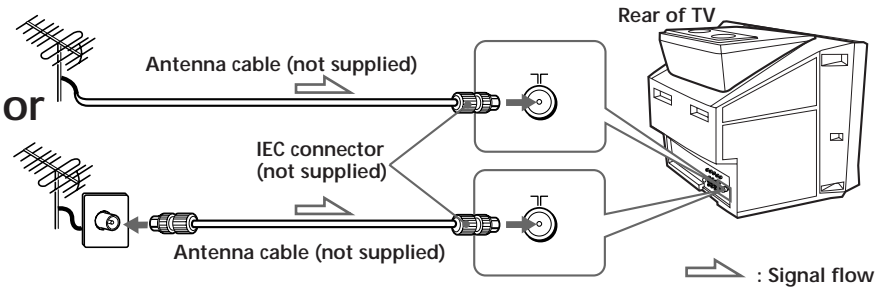





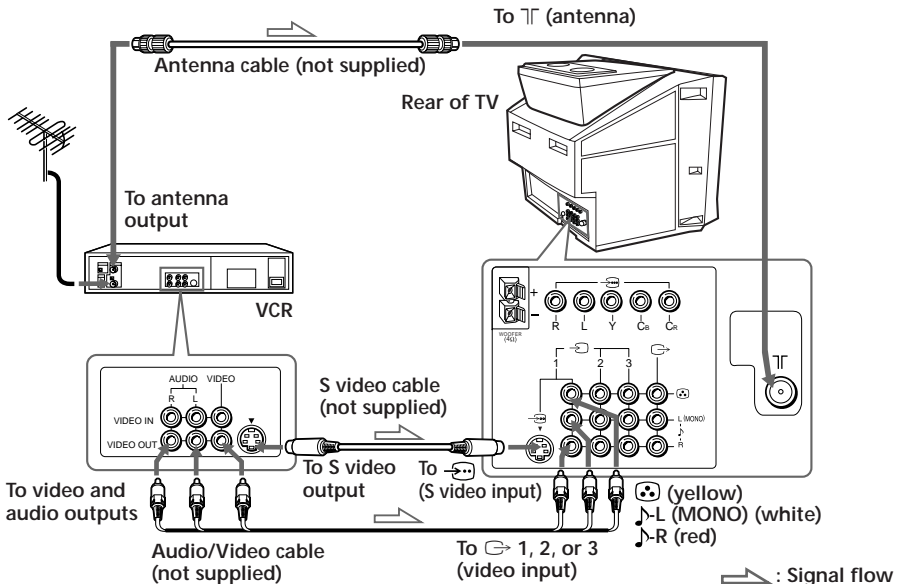

Connecting a VCR

To watch the video input, press \rightarrow (see page 12).



Notes

- If you connect a monaural VCR, connect the yellow plug to  (the yellow jack) and the black plug to  (MONO) (the white jack).
- If you connect a VCR to the  (antenna) terminal, preset the signal output from the VCR to the program number 0 on the TV.
- When both the  (S video input) and  1 (video input) are connected, the  (S video input) is automatically selected. To view the video input to  1 (video input), disconnect the S video cable.
- When no signal is input from the connected video equipment, the TV screen becomes blue.

Step 2

Insert the batteries into the remote

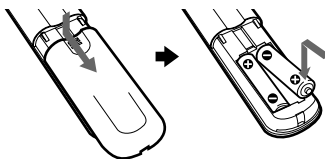

Note

- Do not use old batteries or different types of batteries together.

Step 3

Preset the channels automatically

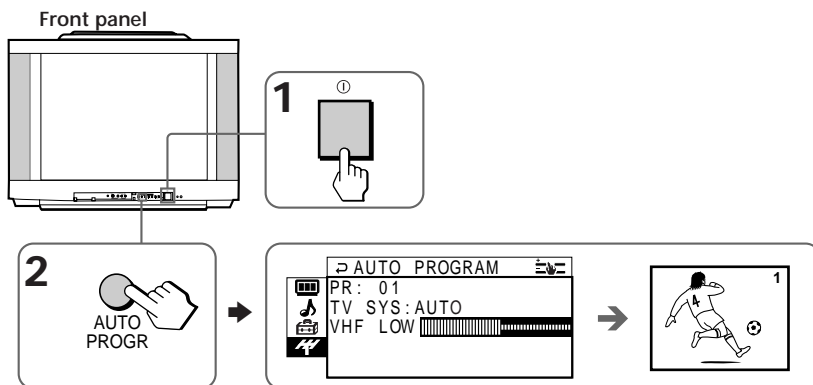

Tips

- To stop the automatic channel presetting, press MENU.
- If your TV has preset an unwanted channel or cannot preset a particular channel, then preset your TV manually (see page 31).

Connecting the 3D WOOFER

You can enjoy high quality sound by connecting the 3D WOOFER.

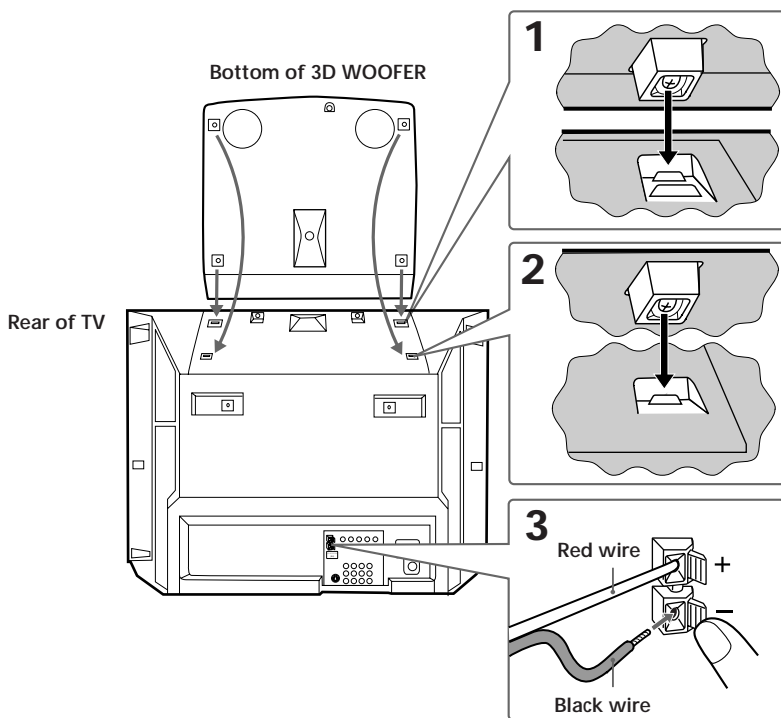

- 1** Place the foot at the front of the 3D WOOFER into the footholds on the top of your TV.
- 2** Place the foot at the rear of the 3D WOOFER into the footholds at the rear of your TV.
- 3** Connect the wires to the 3D WOOFER (4Ω) terminals at the rear of your TV. The red wire should be connected to the ⊕ red terminal and the black wire to the ⊖ black terminal.

Notes

- Connect only the supplied 3D WOOFER; otherwise your TV may malfunction.
- Unplug your TV from the wall outlet when connecting the 3D WOOFER.
- To prevent a malfunction caused by a short circuit of the terminals, make sure that none of the 3D WOOFER wire strands stick out, making contact with its neighbouring 3D WOOFER terminal.

Connecting optional components



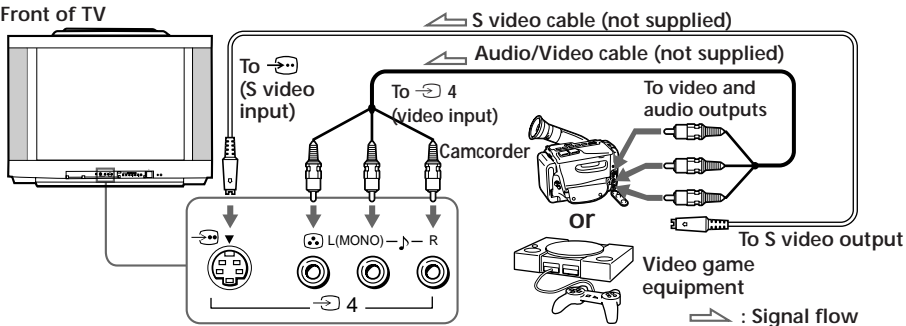

You can connect optional audio/video components, such as a VCR, multi disc player, camcorder, video game, or stereo system. To watch the picture from the connected equipment, see page 12.

Connecting a camcorder/video game equipment using the (video input) jacks

Front of TV



Notes

- When connecting video game equipment, display the "PICTURE" menu and select "ON" for "GAME MODE" to adjust the picture setting that is suitable for video games (see page 24).
- You can also connect video equipment to the , 1, 2, or 3 (video input) jacks at the rear of your TV.
- When both the  (S video input) and  4 (video input) are connected, the  (S video input) is automatically selected. To view the video input to  4 (video input), disconnect the S video cable.

Connecting audio/video equipment using the (monitor output) jacks

Rear of TV

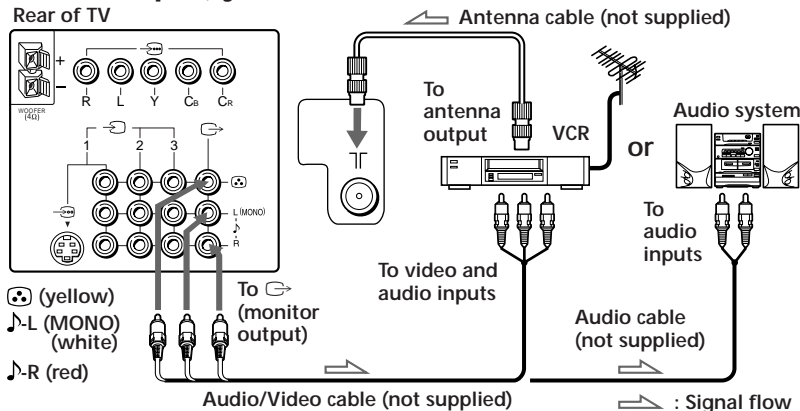



Note

- If you select "DVD" on your TV screen, no signal will be output at the  (monitor output) jacks (see page 12).

continued

Connecting optional components (continued)

Connecting a DVD player to (component video input)

- 1 Using an audio cable, connect R and L under  (component video input) on your TV to the LINE OUT, AUDIO R and L output connectors on your DVD player.
- 2 Using a component video cable, connect Y, C_B, and C_R under  (component video input) on your TV to the COMPONENT VIDEO OUT Y, C_B, and C_R output connectors on your DVD player.
- 3 Press  on the remote or the TV until "DVD" appears on the screen.

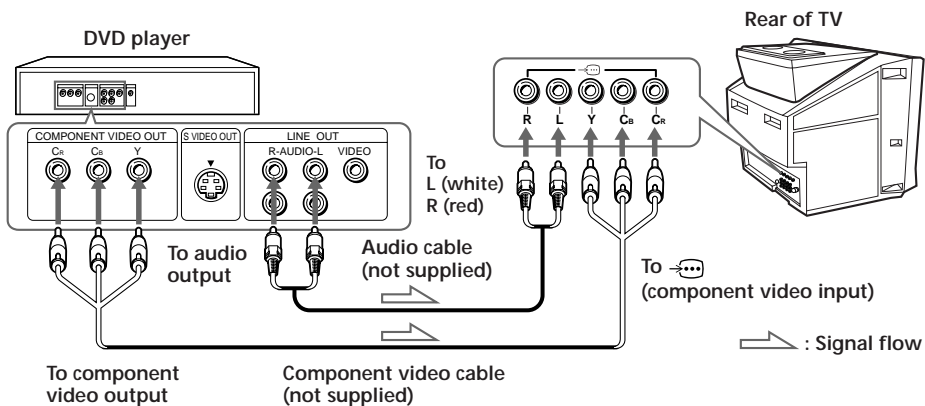



Notes

- Some DVD player terminals may be labeled differently:

Connect	To (on the DVD player)
Y (green)	Y
C _B (blue)	C _b , B-Y or P _B
C _R (red)	C _r , R-Y or P _R

- When connecting to  (component video input) on your TV, you must connect Y, C_B, and C_R to receive the video signals, and connect L and R to receive analog audio signals.

Connecting a DVD player to (video input)

Connect , 1, 2, or 3 (video input)  (audio/video) connectors on your TV to LINE OUT on your DVD player.

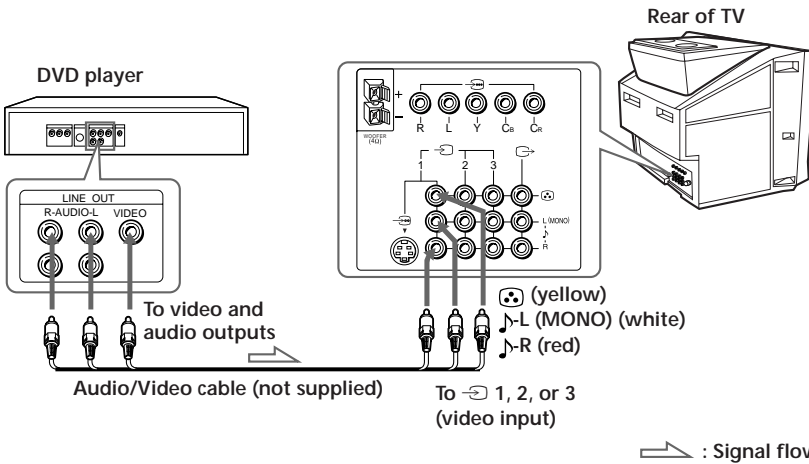

Notes

- Since the high quality pictures on a DVD disc contain a lot of information, picture noise may appear. In this case, adjust the sharpness (“SHARP”) under “PERSONAL ADJUST” in the “PICTURE MODE” menu (see page 25).
- Connect your DVD player directly to your TV. Connecting the DVD player through other video equipment will cause unwanted picture noise.

Securing the TV

To prevent the TV from falling, secure the TV using one of the following methods:

A With the supplied screws, attach the stabilizer band to the TV stand and to the rear of the TV using the provided hole.

OR

B Put the cord or chain through the clamps to secure the TV against a wall or pillar.

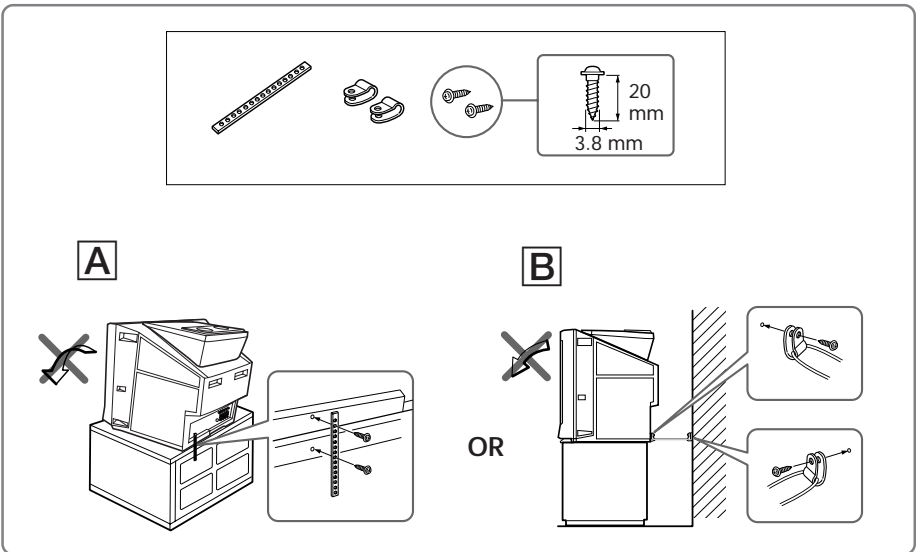

Note

- Use only the supplied screws. Use of other screws may damage the TV.

Watching the TV

This section explains various functions and operations available while watching the TV. Most operations can be done using the remote.

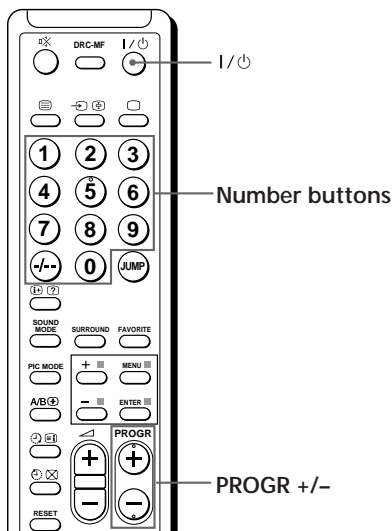
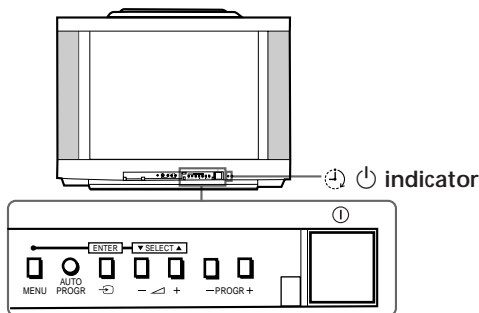

1 Press ① to turn on the TV.

When the TV is in standby mode (the indicator on the TV is lit red), press I/ on the remote or PROGR +/- on the TV.

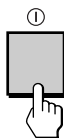

2 Press PROGR +/- or the number buttons to select the TV channel.

For double digit numbers, press -/-, then the number (e.g., for 25, press -/-, then 2 and 5).

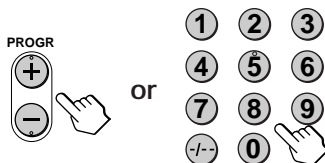

Note

- When you turn on the TV, either the program number or video mode is displayed for approximately 40 seconds. The ECO MODE () icon will also appear if "ECO MODE " in the "SETUP" menu is set "ON" (see page 28).

To select a TV program quickly

- Press and hold PROGR +/-.
- Release PROGR +/- when the desired program number appears.

Note

- When you select a TV program quickly, the picture may be disrupted. This does not indicate a malfunction.

continued

Watching the TV (continued)

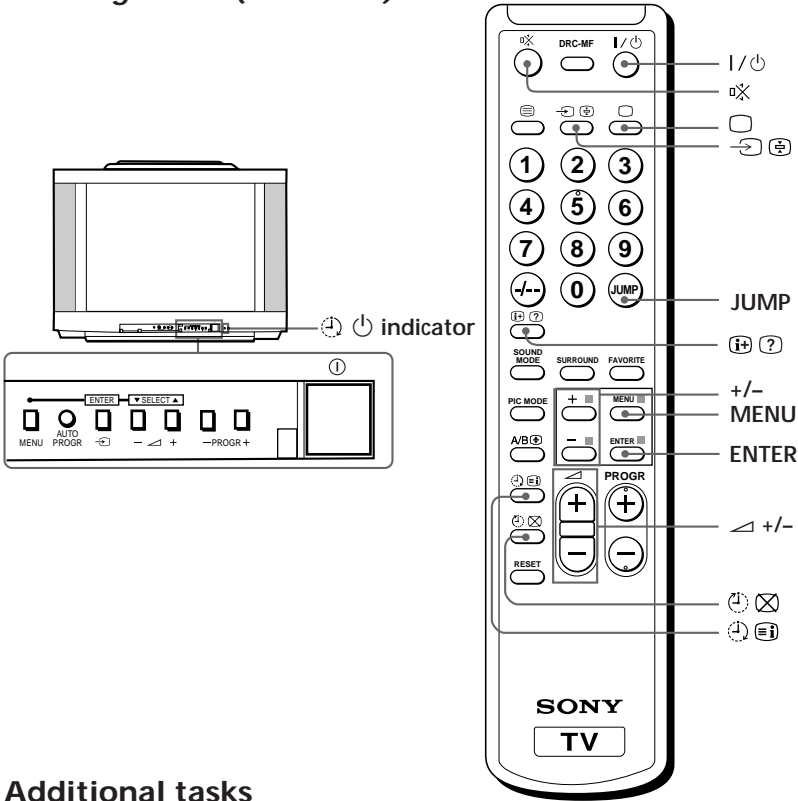

Additional tasks

To	Press
Turn off temporarily	I / power . The power indicator on the TV lights up red.
Turn off completely	① on the TV.
Adjust the volume	volume +/-.
Mute the sound	mute .
Watch the video input (VCR, camcorder, etc.)	channel (or channel on the TV) to select "VIDEO 1", "VIDEO 2", "VIDEO 3", "VIDEO 4" or "DVD". To return to the TV screen, press channel (or channel on the TV).
Jump back to the previous channel	JUMP.
Display the on-screen information*	info .

* Some picture/sound settings, and either the program number or video mode are displayed. The on-screen display for the picture/sound settings disappears after about 3 seconds.

Changing the menu language

You can change the menu language as well as the on-screen language. For details on how to use the menu, see **Introducing the menu system** on page 21.

- 1** Press MENU.

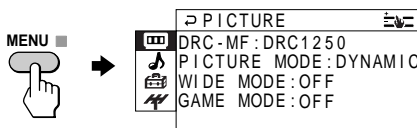

- 2** Press + or - to select , then press ENTER.

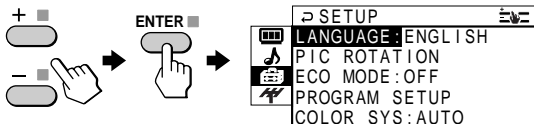

- 3** Make sure "LANGUAGE" is selected then press ENTER.

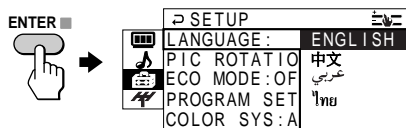

- 4** Press + or - to select the desired language (e.g., "中文"), then press ENTER.

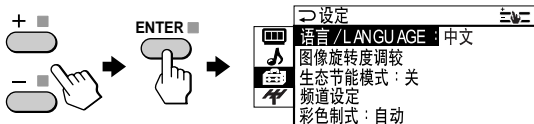

The selected menu language appears.

To return to the normal screen

Press MENU.



continued

Watching the TV (continued)

Setting the Wake Up timer

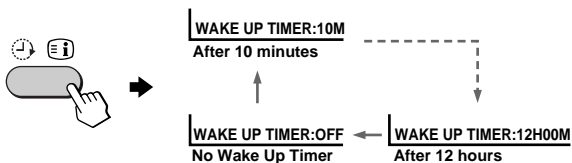
- 1 Press  until the desired period of time appears.
The Wake Up timer starts immediately after you have set it.



- 2 Select the TV channel or video mode you want to wake up to.
- 3 Press , or set the Sleep timer if you want the TV to turn off automatically.
The  indicator on the TV lights up orange.

To cancel the Wake Up timer

Press  until “WAKE UP TIMER: OFF” appears, or turn off the TV’s main power.

Note

- If no buttons or controls are pressed for more than two hours after the TV is turned on using the Wake Up timer, the TV automatically goes into standby mode. To resume watching the TV, press any button or control on the TV or the remote.

Setting the Sleep timer

- Press  until the desired period of time appears.
The Sleep timer starts immediately after you have set it.

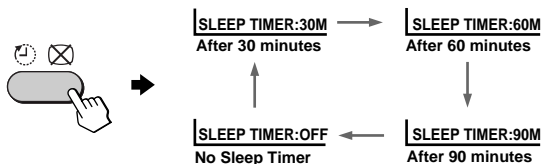

To cancel the Sleep timer

Press  until “SLEEP TIMER: OFF” appears, or turn the TV off.

Selecting the picture and sound modes

You can select picture and sound modes and adjust the setting to your preference in the “PERSONAL” option.

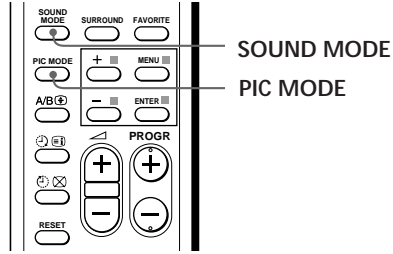

Selecting the picture mode

Press PIC MODE repeatedly until the desired picture mode is selected.

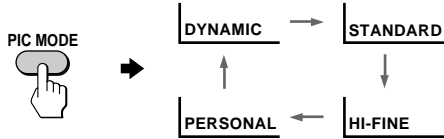

Select	To
“DYNAMIC”	receive high contrast pictures.
“STANDARD”	receive normal pictures.
“HI-FINE”	receive higher resolution pictures with mild contrast.
“PERSONAL”	receive the last adjusted picture setting from the “ADJUST” option in the “PICTURE” menu (see page 25).

Selecting the sound mode

Press SOUND MODE repeatedly until the desired sound mode is selected.

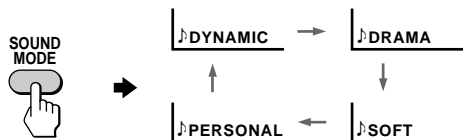

Select	To
“DYNAMIC”	listen to dynamic and clear sound that emphasizes both the low and high tones.
“DRAMA”	listen to sound that emphasizes voice and high tones.
“SOFT”	receive soft sound.
“PERSONAL”	receive the last adjusted sound setting from the “ADJUST” option in the “SOUND” menu (see page 27).

Tip

- You can also set the picture and sound modes using the menu (see **Changing the “PICTURE” setting** on page 24 and **Changing the “SOUND” setting** on page 26).

Viewing higher quality pictures

— “DRC-MF”

The Digital Reality Creation-Multi Function (DRC-MF) feature allows you to enjoy higher quality pictures on your TV. You can select “DRC1250” to watch super real (higher resolution) pictures, or “DRC PROGRESSIVE” to reduce any jittering on the screen if necessary.

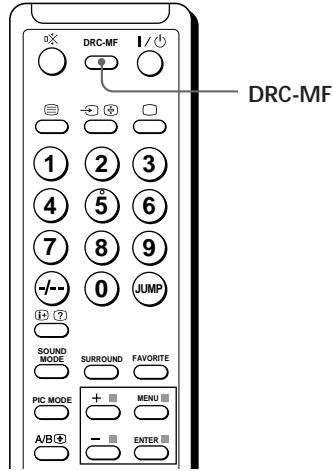

Press DRC-MF repeatedly until you receive the desired picture quality.

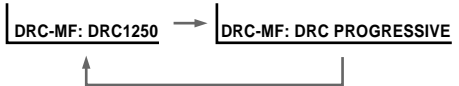

Select	To
“DRC1250”	select higher resolution pictures.
“DRC PROGRESSIVE”	reduce jitter of any small areas or scanning lines (e.g., letters or the edge of objects) on the screen.

Tips

- You can also select the DRC-MF option using the menu (see **Changing the “PICTURE” setting** on page 24).
- When the broadcast signal is weak, you may see some dots or noise on the TV screen. To reduce this interference, display the “PICTURE” menu and select “ADJUST” in “PICTURE MODE”, then adjust “SHARP” to reduce the sharpness (see page 25).

Note

- The DRC-MF mode is not selectable when the “GAME MODE” is turned “ON”.

The DRC-MF logo () and “DRC-MF” are trademarks of Sony Corporation.

Viewing your favorite channels

You can display and select six of your favorite channels directly from your TV screen.

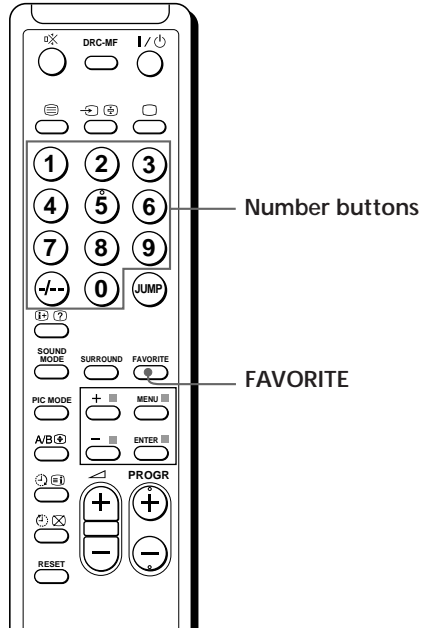

1 Press FAVORITE.

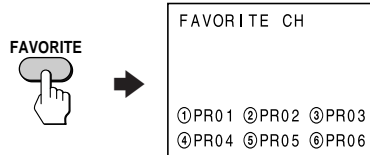

2 Press the number button from 1 to 6 to select the desired channel.

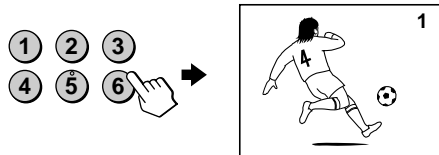

Tip

- To program your favorite channels, see **Adjusting each channel settings (PROGRAM SETUP)** on page 29.

Listening with surround sound

The surround feature enables you to enjoy the sound effects of a concert hall or movie theater.

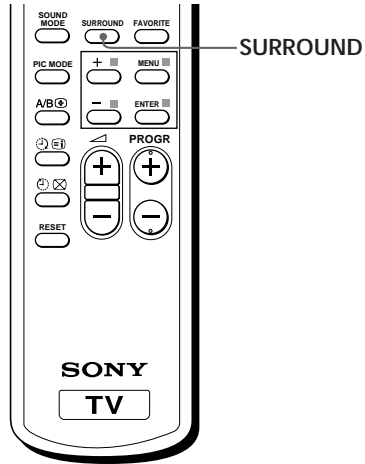

Press SURROUND repeatedly until you receive the desired surround sound.

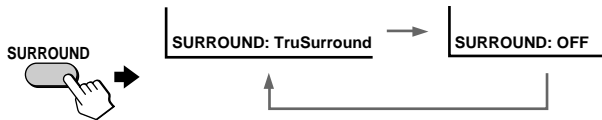

Select	To
“TruSurround”	listen to the surround sound that spreads out to the rear of a room.
“OFF”	turn off the surround sound.

Tip

- You can also select the surround option using the menu (see **Changing the “SOUND” setting** on page 26).

The surround of your TV is categorized as TruSurround.

TruSurround™ is a trademark of SRS Labs, Inc. SRS and the SRS symbol are registered trademarks of SRS Labs, Inc. in the United States and selected foreign countries. SRS and TruSurround are incorporated under license from SRS Labs, Inc. and are protected under United States Patent Nos. 4,748,669 and 4,841,572 with numerous additional issued and pending foreign patents.

Enjoying stereo or bilingual programs

(KV-EX34M93 only)

You can enjoy stereo sound or bilingual programs of NICAM stereo system.

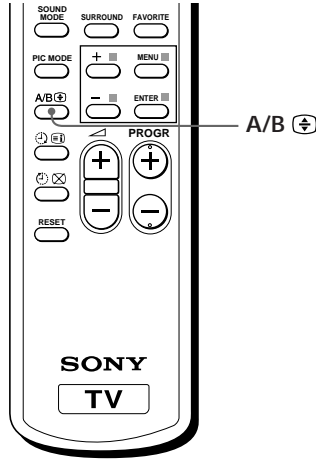
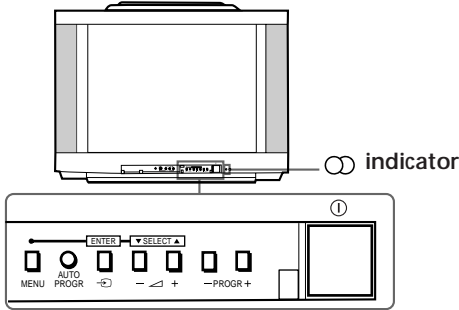

Press A/B repeatedly until you receive the sound you want.

The on-screen display changes to show the selected sound.

The  indicator on the TV lights up red when receiving any stereo or bilingual program.

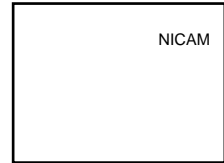

When receiving a NICAM program

Broadcasting	On-screen display (Selected sound)
NICAM stereo	<pre> graph LR A["NICAM (Stereo sound)"] --> B["MONO (Regular sound)"] </pre>
NICAM bilingual	<pre> graph LR A["NICAM MAIN (Main sound)"] --> B["NICAM SUB (Sub sound)"] B --> C["MONO (Regular sound)"] </pre>
NICAM monaural	<pre> graph LR A["NICAM MAIN (Main sound)"] --> B["MONO (Regular sound)"] </pre>

continued

Enjoying stereo or bilingual programs (continued)

Notes

- If the signal is very weak, the sound becomes monaural automatically.
- If the stereo sound is noisy when receiving a NICAM program, select “MONO”. The sound becomes monaural, but the noise is reduced.
- Before receiving a NICAM stereo program in China, please check the NICAM broadcast condition in your area. When receiving a NICAM stereo program, the receiving conditions might vary depending on area. In addition, different strength of the NICAM broadcast signal might affect the receiving quality.

If the sound is distorted when receiving a monaural program through the (antenna) terminal

Press A/B repeatedly until “MONO” appears on the screen.

To cancel the monaural sound setting, press A/B again until “AUTO” appears on the screen.





Notes

- The “MONO” or “AUTO” setting is memorized for each program position.
- You cannot receive a stereo broadcast signal when the TV is in the “MONO” setting. Normally, set the TV to “AUTO”.

Introducing the menu system

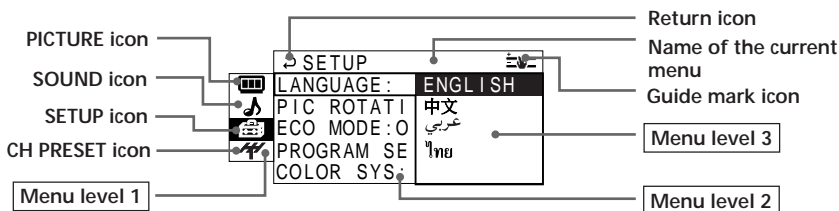

The MENU button lets you open a menu and change the settings of your TV. The following is an overview of the menu system.



Level 1	Level 2	Level 3/Function
"PICTURE" 	"DRC-MF"	Select the "DRC-MF" mode: "DRC1250" → "PROGRESSIVE"
	"PICTURE MODE"	Select the picture mode: "DYNAMIC" → "STANDARD" → "HI-FINE" → "PERSONAL" → "ADJUST"
	"ADJUST"	Adjust the "PERSONAL" option: "PICTURE" → "COLOR" → "BRIGHT" → "HUE" → "SHARP"
	"WIDE MODE"	Change the picture size.
	"GAME MODE"	Adjust the picture settings for video games.
"SOUND" 	"SOUND MODE"	Select the sound mode: "DYNAMIC" → "DRAMA" → "SOFT" → "PERSONAL" → "ADJUST"
	"ADJUST"	Adjust the "PERSONAL" option: "BASS" → "TREBLE" → "BALANCE" → "BBE"*
	"SURROUND"	Select the "SURROUND" mode: "TruSurround" → "OFF"
	"INTELLIGENT VOL"	Adjust volume automatically.

continued

Introducing the menu system (continued)

Level 1	Level 2	Level 3/Function
"SETUP" 	"LANGUAGE"	Change the menu language: "ENGLISH" → "中文" (Chinese) → "عربي" (Arabic) → "ไทย" (Thai)
	"PIC ROTATION"	Adjust the picture position.
	"ECO MODE"	Reduce power consumption of your TV.
	"PROGRAM SETUP"	Adjust each channel settings.
	"COLOR SYS"	Select the color system: "AUTO" → "PAL" → "SECAM" → "NTSC3.58" → "NTSC4.43"
"CH PRESET" 	"AUTO PROGRAM"	Preset channels automatically.
	"MANUAL PROGRAM"	Preset channels manually.
	"TV SYS"	Select the TV system: "B/G" → "I" → "D/K" → "M"

* The BBE is manufactured by Sony Corporation under license from BBE Sound, Inc. It is covered by U.S. Patent No. 4,638,258 and No. 4,482,866. The word "BBE" and the BBE symbol are the trademarks of BBE Sound, Inc.

How to use the menu

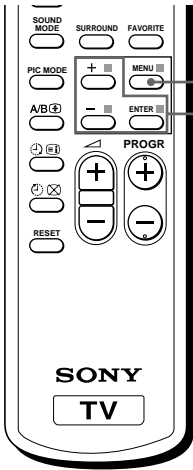

Press MENU to display the menu.

Press + or - to select the desired item.

Press ENTER to confirm your selection and go to the next level.

Other menu operations

To	Press
Adjust the setting value	+ or -.
Return to the previous menu level	ENTER.
Cancel the menu	MENU.

Tips

- If you want to exit from Menu level 2 to Menu level 1, press + or - until the return icon (↶) is highlighted, then press ENTER.
- Some of the menu items can be operated directly using the remote buttons.
- The MENU, ENTER, and SELECT ▼/▲ buttons on the TV can also be used for the operations above.

Front of TV

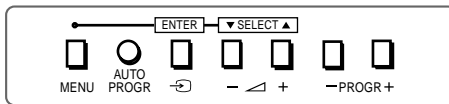

Note

- If more than 60 seconds elapse between entries, the menu screen automatically disappears.

Changing the “PICTURE” setting

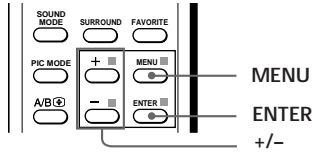

The “PICTURE” menu allows you to adjust the picture settings.

1 Press MENU.

2 Make sure the “PICTURE” icon (📺) is selected, then press ENTER.

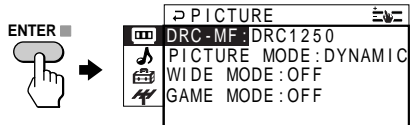

3 Press + or – to select the desired item (e.g., “DRC-MF”), then press ENTER.



Select	To
“DRC-MF”	choose either “DRC1250” or “PROGRESSIVE”.
“PICTURE MODE”	choose either “DYNAMIC”, “STANDARD”, “HI-FINE”, “PERSONAL”*, or “ADJUST”.
“WIDE MODE”	change the picture size when receiving wide-mode (16:9) picture signal. Press + or – to select “ON”, then press ENTER. To cancel, select “OFF”, then press ENTER.
“GAME MODE”	adjust the picture setting that is suitable to view video games. Press + or – to select “ON”, then press ENTER. To cancel, select “OFF”, then press ENTER.

* When the “PERSONAL” mode is selected, you can receive the last adjusted picture settings from the “ADJUST” option (see page 25).

Notes

- For details on the options under “DRC-MF” and “PICTURE MODE”, see pages 16 and 15 respectively.
- “GAME MODE” is available only when receiving signals through the (video input), (S video input), or (component video input) jacks at the front and rear of your TV.

To return to the normal screen

Press MENU.

Adjusting the “ADJUST” items under “PICTURE MODE”

- 1** Press + or – to select the desired item (e.g., “COLOR”), then press ENTER.

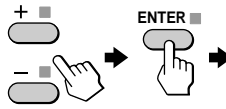

- 2** Adjust the value according to the following table, then press ENTER.

For	Press – to	Press + to
“PICTURE”	decrease picture contrast	increase picture contrast
“COLOR”	decrease color intensity	increase color intensity
“BRIGHT”	darken the picture	brighten the picture
“HUE”*	increase red picture tones	increase green picture tones
“SHARP”	soften the picture	sharpen the picture

* You can adjust “HUE” for the NTSC color system only.

- 3** Repeat the above steps to adjust other items.
The adjusted settings will be received when you select “PERSONAL”.

Tip

- For details on the menu system and how to use the menu, refer to **Introducing the menu system** on page 21.

Changing the "SOUND" setting

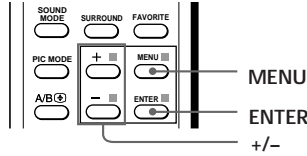

The "SOUND" menu allows you to adjust the sound settings.

1 Press MENU.

2 Press + or - to select the "SOUND" icon (🔊), then press ENTER.

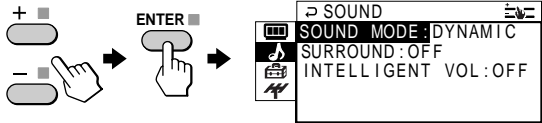

3 Press + or - to select the desired item (e.g., "SOUND MODE"), then press ENTER.

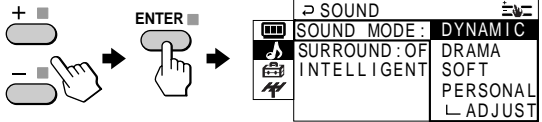

Select	To
"SOUND MODE"	choose either "DYNAMIC", "DRAMA", "SOFT", "PERSONAL"*, or "ADJUST".
"SURROUND"	choose either "TruSurround" or "OFF".
"INTELLIGENT VOL"	adjust the volume of all TV programs and video inputs automatically. Press + or - to select "ON", then press ENTER. To cancel, select "OFF", then press ENTER.

* When the "PERSONAL" mode is selected, you can receive the last adjusted sound settings from the "ADJUST" option (see page 27).

Note

- For details on the options under "SOUND MODE" and "SURROUND", see pages 15 and 18 respectively.

To return to the normal screen

Press MENU.

Adjusting the “ADJUST” items under “SOUND MODE”

- 1** Press + or – to select the desired item (e.g., “BALANCE”), then press ENTER.

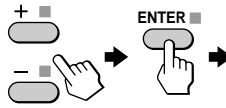

BALANCE  00

- 2** Adjust the value according to the following table, then press ENTER .

For	Press – to	Press + to
“BASS”	decrease the bass	increase the bass.
“TREBLE”	decrease the treble	increase the treble.
“BALANCE”	increase the left speaker’s volume	increase the right speaker’s volume.
“BBE”	select “HIGH” for higher enhancement of sound clarity; select “LOW” for lower enhancement of sound clarity; select “OFF” to turn off the BBE sound.	

- 3** Repeat the above steps to adjust other items.
The adjusted settings will be received when you select “PERSONAL”.

Tip

- For details on the menu system and how to use the menu, refer to **Introducing the menu system** on page 21.

Changing the "SETUP" setting

The "SETUP" menu allows you to change the menu language, adjust the picture position, reduce your TV power consumption, setup your programs and select the color system.

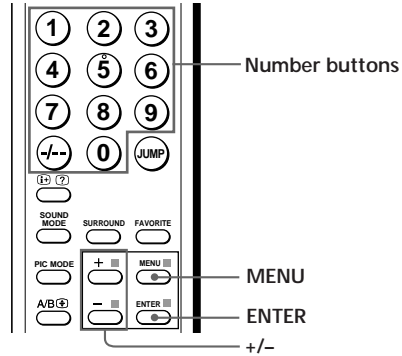

1 Press MENU.

2 Press + or - to select the "SETUP" icon (📺), then press ENTER.

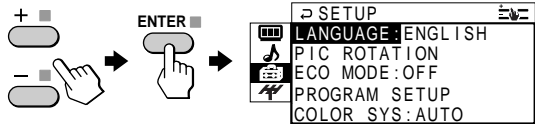

3 Press + or - to select the desired item (e.g., "COLOR SYS"), then press ENTER.

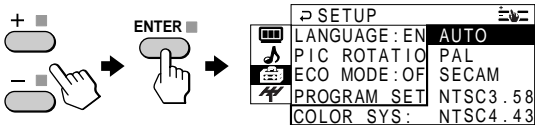

Select	To
"LANGUAGE"	change the menu language (see Changing the menu language on page 13).
"PIC ROTATION"	adjust the picture position when it is not aligned with the TV screen. Press + or - to adjust the picture position, then press ENTER.
"ECO MODE"	reduce power consumption of your TV to save energy. Press + or - to select "ON", then press ENTER. To cancel, select "OFF", then press ENTER.
"PROGRAM SETUP"	adjust each channel settings (see Adjusting each channel settings (PROGRAM SETUP) on page 29).
"COLOR SYS"	select the color system. Normally, set this to "AUTO".

To return to the normal screen

Press MENU.

Adjusting each channel settings (PROGRAM SETUP)

1 Select "PROGRAM SETUP" from the "SETUP" menu.

2 Select "PR" and press ENTER. Press + or - to select the desired channel you want to adjust, then press ENTER.

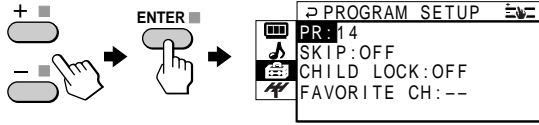

3 Press + or - to select the desired item (e.g., "SKIP"), then press ENTER.



Select	To
"PR"	select the desired channel.
"SKIP"	skip unwanted or unused program number. Press + or - to select "ON", then press ENTER. To cancel, select "OFF", then press ENTER.
"CHILD LOCK"	prevent children from watching this selected channel. Press + or - to select "ON", then press ENTER. The lock symbol (🔒) appears on the screen. To cancel, select "OFF", then press ENTER. If you preset a locked channel, that channel will be unlocked automatically.
"FAVORITE CH"	program six channels for direct selection. Press + or - to select one of the six favorite channel numbers (if you decide not to make any changes, select "↵"), then press ENTER. To view the selected favorite channel, refer page 17.

4 To continue adjusting other channels, press + or - to select "PR", then repeat step 2 and 3.

To return to the normal screen

Press MENU.

Changing the Channel Preset (“CH PRESET”) setting

The “CH PRESET” menu allows you to adjust the setup of your TV. For example, you can manually tune in a channel with a weak signal that fails to be tuned in by automatic presetting.

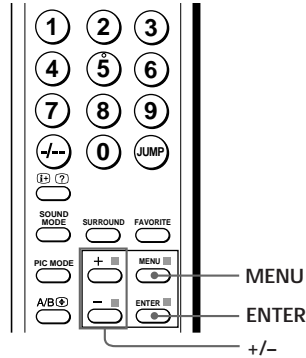

1 Press MENU.

2 Press + or – to select the “CH PRESET” icon (⚡), then press ENTER.

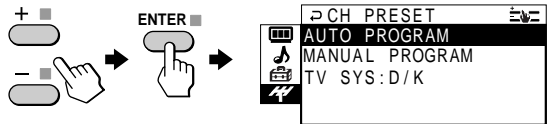

3 Press + or – to select the desired item (e.g., “AUTO PROGRAM”), then press ENTER.

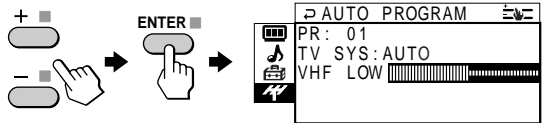

Select	To
“AUTO PROGRAM”	preset channels automatically.
“MANUAL PROGRAM”	preset channels manually. See Presetting channels manually on page 31.
“TV SYS”	select the TV system. Press + or – to select either “B/G”, “I”, “D/K” or “M”, then press ENTER.

To return to the normal screen

Press MENU.

Tip

- For details on the menu system and how to use the menu, refer to **Introducing the menu system** on page 21.

Presetting channels manually

1 After selecting “MANUAL PROGRAM”, select the program number to which you want to preset a channel.

(1) Make sure “PR” is selected, then press ENTER.

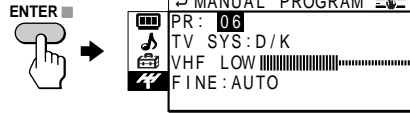

(2) Press + or - until the program number you want to preset (e.g., program number “10”) appears on the menu, then press ENTER.

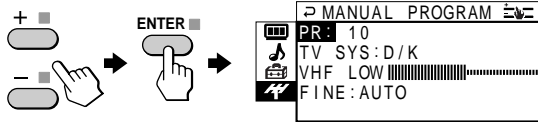

Tip

- You can also select the program number with the PROGR +/- or number buttons.

2 Select the desired channel.

(1) Press + or - to select either “VHF LOW”, “VHF HIGH”, or “UHF”, then press ENTER.

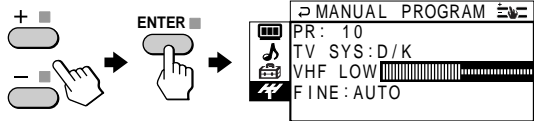

(2) Press + or - until the desired channel's broadcast appears on the TV screen, then press ENTER.

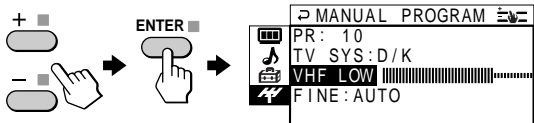

3 If the sound of the desired channel is abnormal, select the appropriate TV system.

(1) Press + or - to select “TV SYS”, then press ENTER.

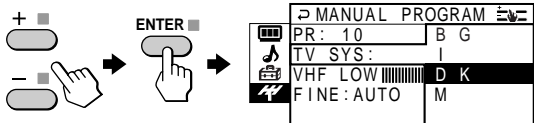

(2) Press + or - until the sound becomes normal, then press ENTER.

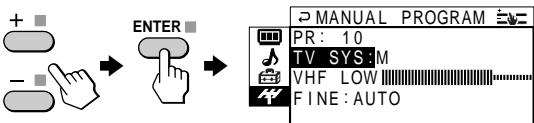

continued

Changing the "CH PRESET" setting (continued)

4 If you are not satisfied with the picture and sound quality, you may be able to improve them by using the "FINE" tuning feature.

- (1) Press + or - to select "FINE", then press ENTER.

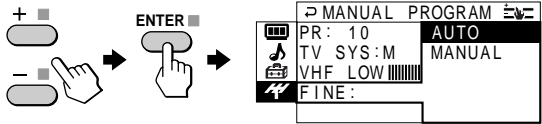

- (2) Press + or - to select "MANUAL", then press ENTER.

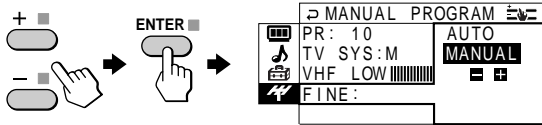

- (3) Press + or - until the picture and sound quality are optimal, then press ENTER. The + or - icon on the menu flashes while tuning.

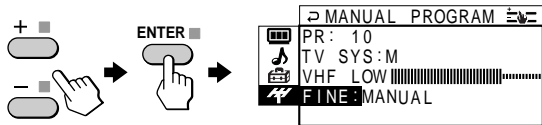

To return to the normal screen

Press MENU.

Notes

- The TV system ("TV SYS") and fine tuning ("FINE") settings are memorized for each program number.
- If you preset a locked channel ("CHILD LOCK"), that channel will be unlocked automatically (see page 29).

Self-diagnosis function

Your TV is equipped with a self-diagnosis function. If there is a problem with your TV, the ⏻ (standby) indicator flashes red. The number of times the ⏻ indicator flashes indicates the possible causes.

Front of TV

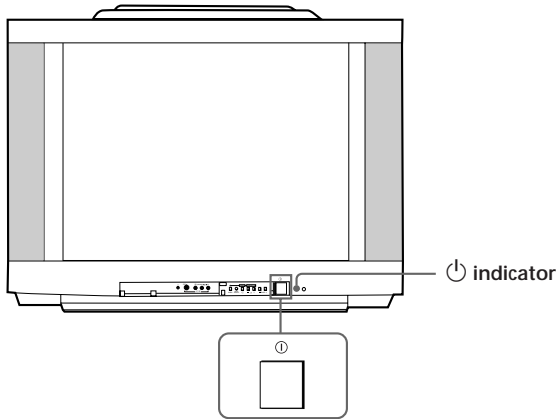

- 1** Check that the ⏻ indicator flashes red a number of times between 3-second intervals.
- 2** Count the number of times the ⏻ indicator flashes.
- 3** Press ⏻ (main power) to turn off your TV.
- 4** Inform your nearest Sony service center about the number of times the ⏻ indicator flashed.
Be sure to note the model name and serial number located on the rear of your TV.

Troubleshooting

If you have any problem while viewing your TV, you can either use the Reset function or check the Troubleshooting guide below. If the problem persists, contact your Sony dealer.





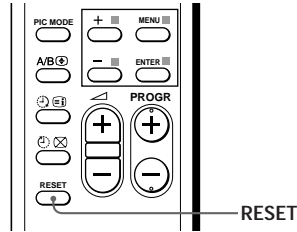

Reset function



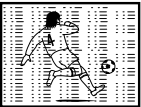



Press the RESET button on your remote control. Your TV will go blank for about half a second then the picture will reappear with “RESET” displayed on your TV screen for about 10 seconds.

Pressing RESET will set your TV to the factory setting, but certain problems may be solved.





Troubleshooting guide

Symptom	Possible cause	Solutions	Page
Snowy picture 	<ul style="list-style-type: none"> The connection is loose or the cable is damaged. Channel presetting is inappropriate or incomplete. 	<ul style="list-style-type: none"> Check the antenna cable and connection on the TV, VCR and at the wall. Display the “CH PRESET” menu and select “MANUAL PROGRAM” to preset the channel again. 	<p>4</p> <p>31</p>
Noisy sound 	<ul style="list-style-type: none"> The antenna type is inappropriate. The antenna direction needs adjustment. Signal transmission is low. 	<ul style="list-style-type: none"> Check the antenna type (VHF/UHF). Contact a Sony dealer for advice. Adjust the antenna direction. Contact a Sony dealer for advice. Try using a booster. 	<p>-</p> <p>-</p> <p>-</p>
Distorted picture 	<ul style="list-style-type: none"> Broadcast signals are too strong. 	<ul style="list-style-type: none"> Turn off or disconnect the booster if it is in use. 	<p>-</p>
Noisy sound 			
Good picture 	<ul style="list-style-type: none"> The TV system setting or channel presetting is inappropriate or incomplete. 	<ul style="list-style-type: none"> If the sound of all the channels are noisy, display the “CH PRESET” menu and select “AUTO PROGRAM” to preset the channels again. If the sound of some channels is noisy, select the channel, then display the “CH PRESET” menu and select the appropriate TV system (“TV SYS”). 	<p>30</p> <p>31</p>
Noisy sound 			

Symptom	Possible cause	Solutions	Page
No picture 	<ul style="list-style-type: none"> The power cord, antenna or VCR is not connected. 	<ul style="list-style-type: none"> Check the power cord, antenna and the VCR connections. 	4
No sound 	<ul style="list-style-type: none"> The TV is not turned on. 	<ul style="list-style-type: none"> Press I/⏻ (power). Press Ⓚ (main power) on the TV to turn off the TV for about five seconds, then turn it on again. 	11 12
Good picture 	<ul style="list-style-type: none"> The volume level is too low. 	<ul style="list-style-type: none"> Press ◀ + to increase the volume level. 	12
No sound 	<ul style="list-style-type: none"> The sound is muted. 	<ul style="list-style-type: none"> Press ⓧ to cancel the muting. 	12
	<ul style="list-style-type: none"> The broadcast signal has a transmission problem. 	<ul style="list-style-type: none"> Press A/B until a better sound is heard. 	19
Dotted lines or stripes 	<ul style="list-style-type: none"> There is local interference from cars, neon signs, hair dryers, power generators, etc. 	<ul style="list-style-type: none"> Do not use a hair dryer or other equipment near the TV. Adjust the antenna direction for minimum interference. Contact a Sony dealer for advice. 	- -
Double images or "ghosts" 	<ul style="list-style-type: none"> Broadcast signals are reflected by nearby mountains or buildings. 	<ul style="list-style-type: none"> Use a highly directional antenna. Use the fine tuning ("FINE") function. 	- 32
No color 	<ul style="list-style-type: none"> The color level setting is too low. 	<ul style="list-style-type: none"> Display the "PICTURE" menu and select "ADJUST" of "PICTURE MODE", then adjust the "COLOR" level. 	25
	<ul style="list-style-type: none"> The color system setting is inappropriate. 	<ul style="list-style-type: none"> Display the "SETUP" menu and check the color system ("COLOR SYS") setting (usually set this to "AUTO"). 	28
	<ul style="list-style-type: none"> The antenna direction needs adjustment. 	<ul style="list-style-type: none"> Adjust the antenna direction. Contact a Sony dealer for advice. 	-

continued

Troubleshooting (continued)

Symptom	Possible cause	Solutions	Page
<p>Abnormal color patches</p> 	<ul style="list-style-type: none"> The magnetic disturbance from external speakers or other equipment, or the direction of the earth's magnetic field may affect the TV. 	<ul style="list-style-type: none"> Keep external speakers or other equipment away from the TV. Do not move the TV while the TV is turned on. Press ⓪ (main power) on the TV to turn off the TV for about five minutes, then turn it on again. 	–
<p>TV cannot receive stereo broadcast signal. (KV-EX34M93 only)</p>	<ul style="list-style-type: none"> The stereo reception setting is inappropriate. 	<ul style="list-style-type: none"> Press A/B until "AUTO" appears on the screen. 	19
<p>Stereo broadcast sound switches on and off or is distorted.</p> <p>OR</p> <p>The sound switches between stereo and monaural frequently. (KV-EX34M93 only)</p>	<ul style="list-style-type: none"> The connection is loose or the cable is damaged. The antenna direction needs adjustment. The broadcast signal has a transmission problem. 	<ul style="list-style-type: none"> Check the antenna cable and connection on the TV, VCR and on the wall. Adjust the antenna direction. Contact a Sony dealer for advice. Press A/B until a better sound is heard. 	4 – 19
<p>Picture slant</p> 	<ul style="list-style-type: none"> The magnetic disturbance from external speakers or other equipment, or the direction of the earth's magnetic field may affect the TV. 	<ul style="list-style-type: none"> Keep external speakers or other electrical equipment away from the TV. Display the "SETUP" menu and adjust "PIC ROTATION" so that the picture is aligned to the TV screen. 	– 28
<p>Lines moving across the TV screen.</p>	<ul style="list-style-type: none"> There is interference from external sources, e.g., heavy machineries, nearby broadcast station. 	<ul style="list-style-type: none"> Use the fine tuning ("FINE") function. 	32
<p>The ⓪ indicator on your TV flashes red a number of times between 3-second intervals.</p>	<ul style="list-style-type: none"> Your TV may need servicing. 	<ul style="list-style-type: none"> Contact your nearest Sony service center. 	33
<p>Cannot play shooting games.</p>	<ul style="list-style-type: none"> Some shooting games which involve pointing a light beam at the TV screen with an electronic gun or rifle cannot be used with your TV. For detail, see the instruction manual supplied with the video game software. 	–	–

Symptom	Possible cause	Solutions	Page
TV cabinet creaks.	<ul style="list-style-type: none"> Changes in room temperature sometimes make the TV cabinet expand or contract, causing a noise. This does not indicate a malfunction. 	—	—
A small “boom” sound is heard when the TV is turned on.	<ul style="list-style-type: none"> The TV’s demagnetizing function is working. This does not indicate a malfunction. 	—	—

Overview of controls

TV front panel

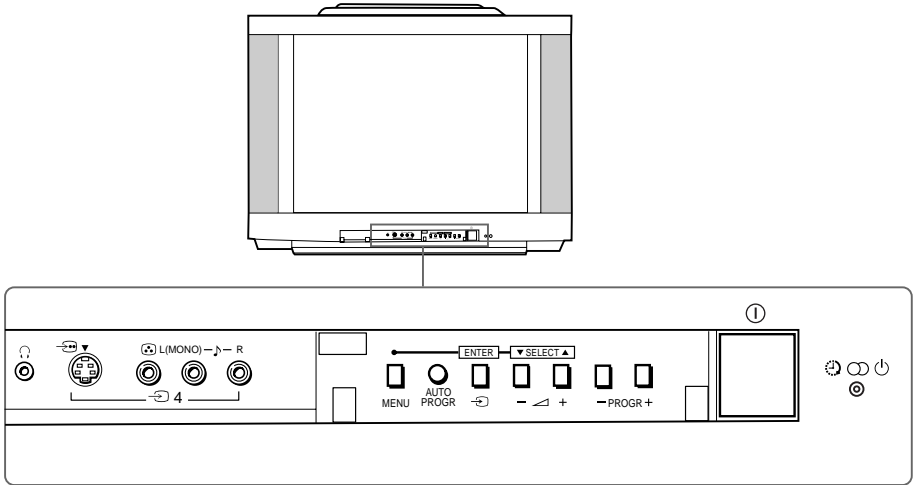

Button	Function	Page
AUTO PROGR	Preset channels automatically.	5
⓪	Turn off completely or turn on the TV.	11
PROGR +/-	Select program number.	11
⓪	Standby indicator.	11
⚡ +/-	Adjust volume.	12
↺	Select TV or video input.	12
⌚	Wake Up indicator.	14
Ⓞ (KV-EX34M93 only)	Stereo/Bilingual indicator.	19
MENU	Display the menu.	23
🎧	Headphone jack.	-

Remote control

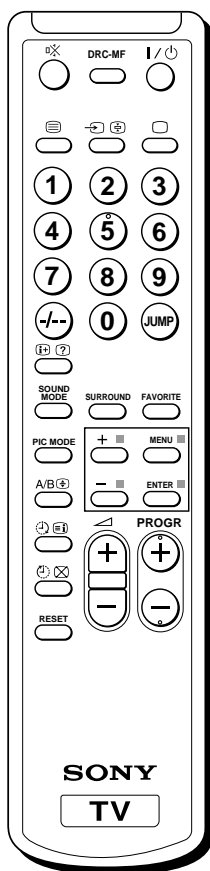

The names/symbols of buttons on the remote are indicated in different colors to represent the available functions.

Label color	Button function
White	For general TV operations
Green	For Teletext operations

Button	Function	Page
I/⏻	Turn off temporarily or turn on the TV.	11
PROGR +/-	Select program number.	11
0 - 9, -/--	Input numbers.	11
ⓘ+	Display on-screen information.	12
⊗	Mute the sound.	12
□	Display the TV program.	12
↶	Select TV or video input.	12
△ +/-	Adjust volume.	12
JUMP	Jump to previous channel.	12
Timer operation		
⌚	Set TV to turn on automatically.	14
⌚	Set TV to turn off automatically.	14
SOUND MODE	Select sound mode.	15
PIC MODE	Select picture mode.	15
DRC-MF	Select DRC-MF mode.	16
Favorite Channel operations		
FAVORITE	Display favorite channels.	17
1 - 6	Select desired channel.	17
SURROUND	Select surround mode.	18
Stereo/bilingual operations (KV-EX34M93 only)		
A/B	Select stereo/bilingual mode.	19
Teletext operations (not used for KV-EX34M93/EX29M83)		
☰	Display Teletext broadcast.	-
ⓘ	Display Teletext service contents.	-
⊕	Stop Teletext display from scrolling.	-
②	Reveal concealed information.	-
⊕	Enlarge the Teletext display.	-
⊗	Show TV screen while waiting for Teletext page.	-
0 - 9	Input Teletext page number.	-
PROGR +/-	Display the next or previous page.	-
■ (red, green, yellow, blue)	Access a FASTEXT menu.	-
Menu operations		
MENU	Display the menu.	23
+, -	Select and adjust items.	23
ENTER	Confirm selected items.	23
RESET	Set TV to factory setting.	34

Specifications

	KV-EX29M83	KV-EX34M93	Note
Power requirements	220 V AC, 50 Hz		
Power consumption (W)	Indicated on the rear of the TV		
Television system	B/G, I, D/K, M		
Color system	PAL, PAL 60, SECAM, NTSC4.43, NTSC3.58		
Stereo/Bilingual system	NICAM Stereo B/G, I, D/K		KV-EX34M93
Channel coverage			
B/G	VHF : E2 to E12 / UHF : E21 to E69 / CATV : S01 to S03, S1 to S41		
I	UHF : B21 to B68 / CATV : S01 to S03, S1 to S41		
D/K	VHF : C1 to C12, R1 to R12 / UHF : C13 to C57, R21 to R60 / CATV : Z1 to Z39, S01 to S03, S1 to S41		
M	VHF : A2 to A13 / UHF : A14 to A79/ CATV : A-8 to A-2, A to W+4, W+6 to W+84		
⌚ (Antenna)	75-ohm external terminal		
Audio output (Speaker)	6W + 6W (4.5W + 4.5W for 7% distortion)		
3D WOOFER	15W (12W for 7% distortion)		
Number of terminal			
📺 (Video)	Input: 4	Output: 1 Phono jacks; 1 Vp-p, 75 ohms	
🎵 (Audio)	Input: 4	Output: 1 Phono jacks; 500 mVrms	
📺 (S Video)	Input: 2	Y: 1 Vp-p, 75 ohms, unbalanced, sync negative C: 0.286 Vp-p, 75 ohms	
📺 (Component Video)	Input: 1	Phono jacks; Y: 1 Vp-p, 75 ohms, sync negative C _B : 0.7 Vp-p, 75 ohms C _R : 0.7 Vp-p, 75 ohms Audio: 500 mVrms	
🎧 (Headphone)	Output: 1	Stereo minijack	
Picture tube	29 type	34 type	
Diagonal tube size (cm)	72	86	
Diagonal screen size (cm)	68	80	
Dimensions (w/h/d, mm)	772 × 603 × 516	895 × 700 × 590	
Mass (kg)	56	84	

Design and specifications are subject to change without notice.

Manufacturer:

SSV Shanghai Suoguang Visual Products Co., Ltd.

3777, Chuan Sha Road,

Pu Dong New District

Zip: 201201

Sony Corporation