

# **Trinitron<sup>®</sup> Color TV**

---

## **Operating Instructions** \_\_\_\_\_ **GB**

- Before operating the unit, please read this manual thoroughly and retain it for future reference.

## **使用説明書** \_\_\_\_\_ **CT**

- 使用本電視機之前請先詳細閱讀此手冊，並妥善保存以備日後用作參考。

## **Panduan Pengendalian** \_\_\_\_\_ **MY**

- Sebelum mengendalikan unit, sila baca buku panduan ini dengan teliti dan simpan untuk rujukan masa depan.

# **KV-EX29**

<b>M65</b>
------------

# WARNING

- Dangerously high voltages are present inside the TV.
- TV operating voltage: 220 – 240 V AC.

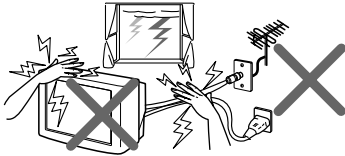

For your own safety, do not touch any part of the TV, the power cord and the antenna cable during lightning storms.



For children's safety, do not leave children alone with the TV. Do not allow children to climb onto it.

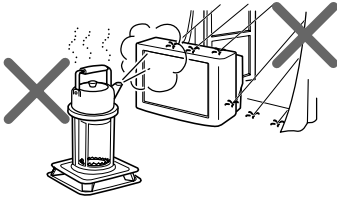

To prevent fire or shock hazard, do not expose the TV to rain or moisture.

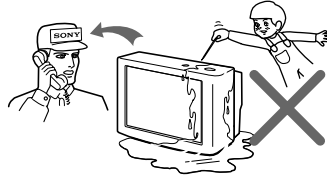

Do not operate the TV if any liquid or solid object falls into it. Have it checked immediately by qualified personnel only.

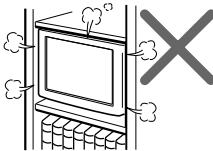

Do not block the ventilation openings of the TV. Do not install the TV in a confined space, such as a bookcase or built-in cabinet.

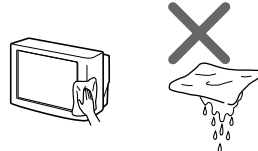

Clean the TV with a dry and soft cloth. Do not use benzene, thinner, or any other chemicals to clean the TV. Do not scratch the picture tube.

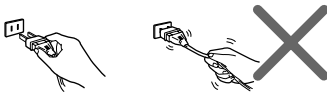

Pull the power cord out by the plug. Do not pull the power cord itself. Disconnect the TV before moving it or if you are not going to use it for several days.

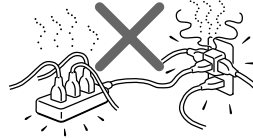

Do not plug in too many appliances to the same power socket. Do not damage the power cord.

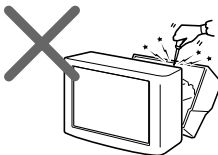

Do not open the cabinet and the rear cover of the TV as high voltages and other hazards are present inside the TV. Refer servicing and disposal of the TV to qualified personnel.

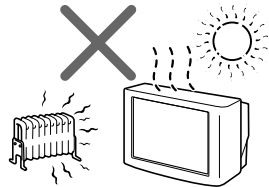

Your TV is recommended for home use only. Do not use the TV in any vehicle or where it may be subject to excessive dust, heat, moisture or vibrations.

# Table of Contents

## Using Your New TV



Getting Started .....	4
Step 1: Connect the antenna .....	4
Step 2: Insert the batteries into the remote .....	5
Step 3: Preset the channels automatically .....	5
Connecting the 3D WOOFER .....	6
Connecting optional components .....	7
Securing the TV .....	10
Watching the TV .....	11

## Advanced Operations

Selecting the picture and sound modes .....	15
Viewing higher quality pictures .....	16
Viewing your favorite channels .....	17
Listening with surround sound .....	18
Enjoying stereo or bilingual programs .....	19
Viewing Teletext .....	21

## Adjusting Your Setup (MENU)

Introducing the menu system .....	23
Changing the "PICTURE" setting  .....	26

Changing the "SOUND" setting  .....	28
Changing the "SETUP" setting  .....	30
Changing the channel preset ("CH PRESET") setting  .....	32

## Additional Information

Self-diagnosis function .....	35
Troubleshooting shortcuts .....	36
Troubleshooting .....	38
Overview of controls .....	42
Specifications .....	Back cover

GB

## WARNING (continued)



Do not install the TV in an unstable position.  
Use a proper TV stand.

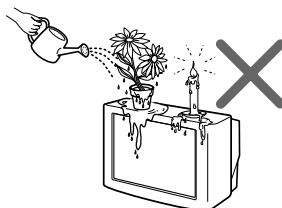

Do not place any objects on the TV.

## Getting Started

### CAUTION

- Do not connect the power cord until you have completed making all other connections; otherwise a minimum leakage current might flow through the antenna and other terminals to ground.
- To avoid battery leakage and damage to the remote, remove the batteries from the remote if you are not going to use it for several days. If any liquid that leaks from the batteries touches you, immediately wash it away with water.

## Step 1

### Connect the antenna

If you wish to connect a VCR, see the **Connecting a VCR** diagram below.

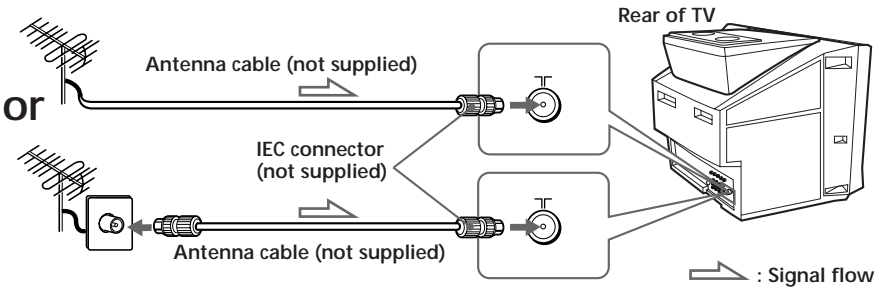





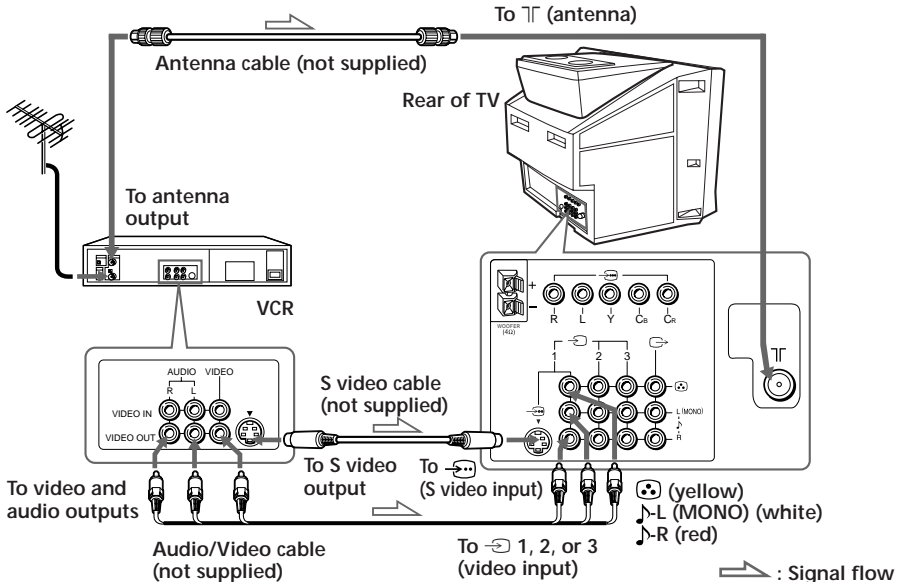

### Connecting a VCR

To watch the video input, press  $\rightarrow$  (see page 12).



**Notes**

- If you connect a monaural VCR, connect the yellow plug to  (the yellow jack) and the black plug to  (MONO) (the white jack).
- If you connect a VCR to the  (antenna) terminal, preset the signal output from the VCR to the program number 0 on the TV.
- When both the  (S video input) and  1 (video input) are connected, the  (S video input) is automatically selected. To view the video input to  1 (video input), disconnect the S video cable.
- When no signal is input from the connected video equipment, the TV screen becomes blue.

## Step 2

### Insert the batteries into the remote

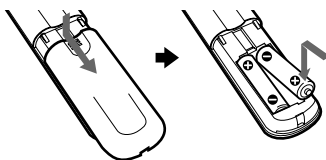
**Note**

- Do not use old batteries or different types of batteries together.

## Step 3

### Preset the channels automatically

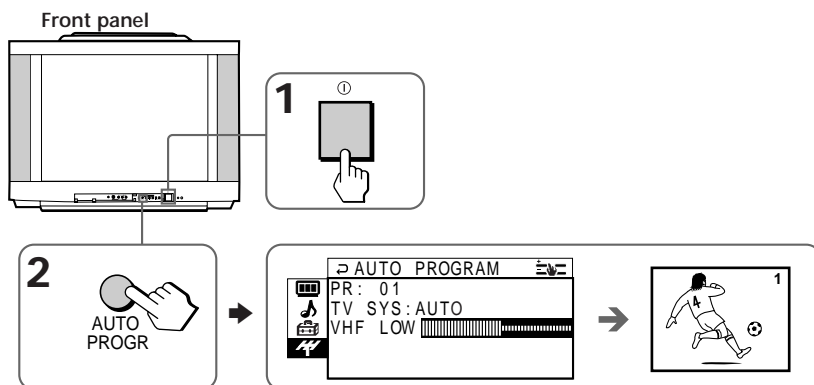
**Tips**

- To stop the automatic channel presetting, press MENU.
- If your TV has preset an unwanted channel or cannot preset a particular channel, then preset your TV manually (see page 33).

# Connecting the 3D WOOFER

You can enjoy high quality sound by connecting the 3D WOOFER.

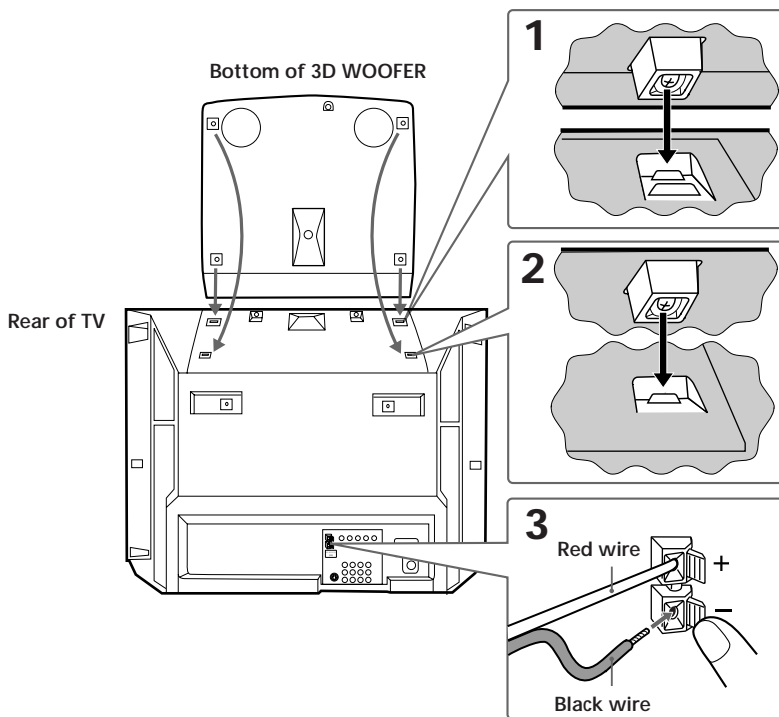

- 1** Place the foot at the front of the 3D WOOFER into the footholds on the top of your TV.
- 2** Place the foot at the rear of the 3D WOOFER into the footholds at the rear of your TV.
- 3** Connect the wires to the 3D WOOFER (4Ω) terminals at the rear of your TV. The red wire should be connected to the ⊕ red terminal and the black wire to the ⊖ black terminal.

## Notes

- Connect only the supplied 3D WOOFER; otherwise your TV may malfunction.
- Unplug your TV from the wall outlet when connecting the 3D WOOFER.
- To prevent a malfunction caused by a short circuit of the terminals, make sure that none of the 3D WOOFER wire strands stick out, making contact with its neighbouring 3D WOOFER terminal.



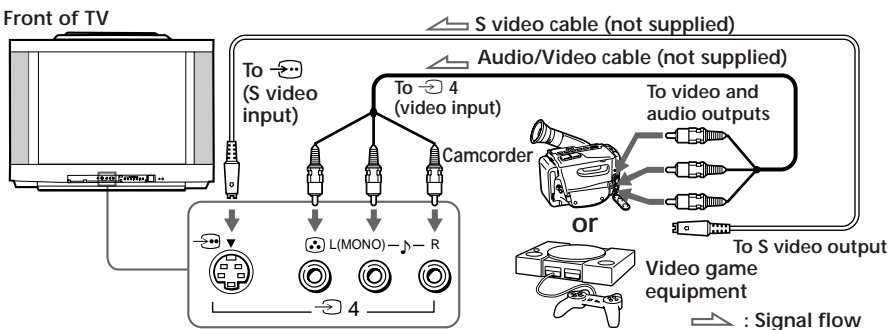

# Connecting optional components

You can connect optional audio/video components, such as a VCR, multi disc player, camcorder, video game, or stereo system. To watch the picture from the connected equipment, see page 12.

## Connecting a camcorder/video game equipment using the (video input) jacks



### Notes

- When connecting video game equipment, display the "PICTURE" menu and select "ON" for "GAME MODE" to adjust the picture setting that is suitable for video games (see page 26).
- You can also connect video equipment to the , 1, 2, or 3 (video input) jacks at the rear of your TV.
- When both the  (S video input) and  4 (video input) are connected, the  (S video input) is automatically selected. To view the video input to  4 (video input), disconnect the S video cable.

## Connecting audio/video equipment using the (monitor output) jacks

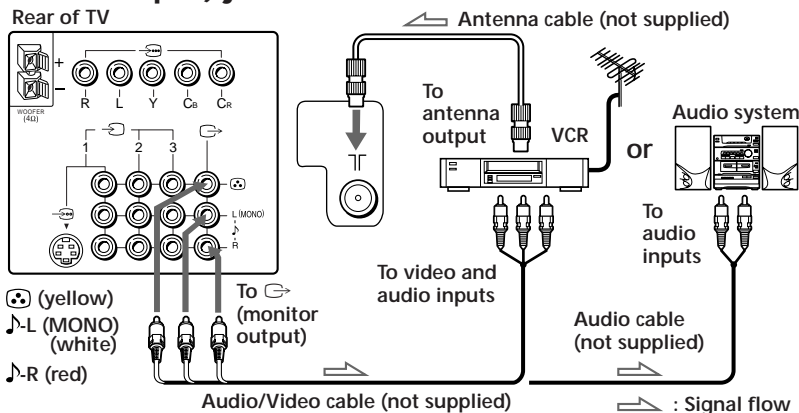



### Note

- If you select "DVD" on your TV screen, no signal will be output at the  (monitor output) jacks (see page 12).

continued

## Connecting optional components (continued)

### Connecting a DVD player to (component video input)

- 1 Using an audio cable, connect R and L under  (component video input) on your TV to the LINE OUT, AUDIO R and L output connectors on your DVD player.
- 2 Using a component video cable, connect Y, C<sub>B</sub>, and C<sub>R</sub> under  (component video input) on your TV to the COMPONENT VIDEO OUT Y, C<sub>B</sub>, and C<sub>R</sub> output connectors on your DVD player.
- 3 Press  on the remote or the TV until "DVD" appears on the screen.

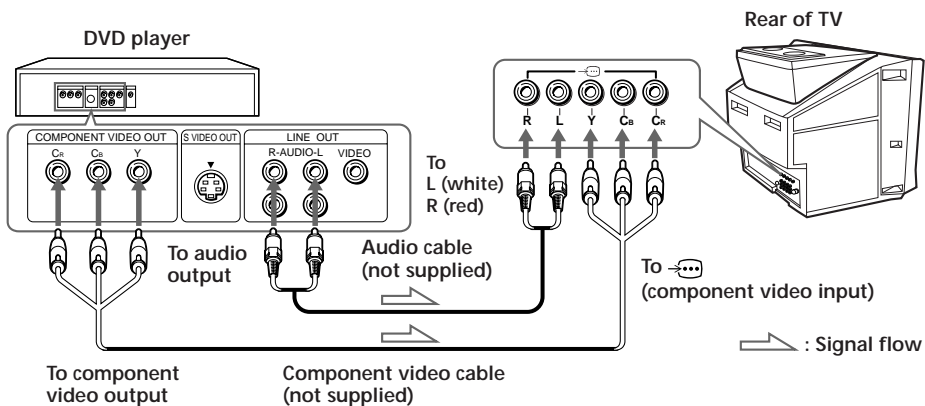

#### Notes



- Some DVD player terminals may be labeled differently:

Connect	To (on the DVD player)
Y (green)	Y
C <sub>B</sub> (blue)	C <sub>b</sub> , B-Y or P <sub>B</sub>
C <sub>R</sub> (red)	C <sub>r</sub> , R-Y or P <sub>R</sub>

- When connecting to  (component video input) on your TV, you must connect Y, C<sub>B</sub>, and C<sub>R</sub> to receive the video signals, and connect L and R to receive analog audio signals.



## Connecting a DVD player to (video input)

Connect , 1, 2, or 3 (video input)  (audio/video) connectors on your TV to LINE OUT on your DVD player.

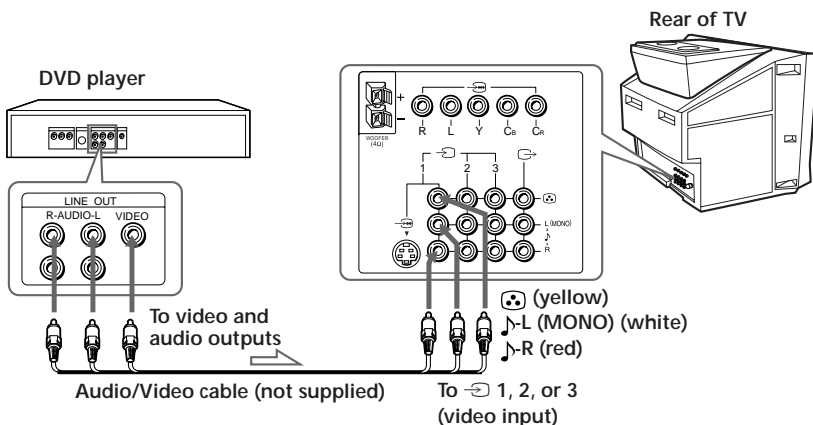

 : Signal flow

### Notes

- Since the high quality pictures on a DVD disc contain a lot of information, picture noise may appear. In this case, adjust the sharpness (“SHARP”) under “PERSONAL ADJUST” in the “PICTURE MODE” menu (see page 27).
- Connect your DVD player directly to your TV. Connecting the DVD player through other video equipment will cause unwanted picture noise.

# Securing the TV

To prevent the TV from falling, secure the TV using one of the following methods:

**A** With the supplied screws, attach the stabilizer band to the TV stand and to the rear of the TV using the provided hole.

OR

**B** Put the cord or chain through the clamps to secure the TV against a wall or pillar.

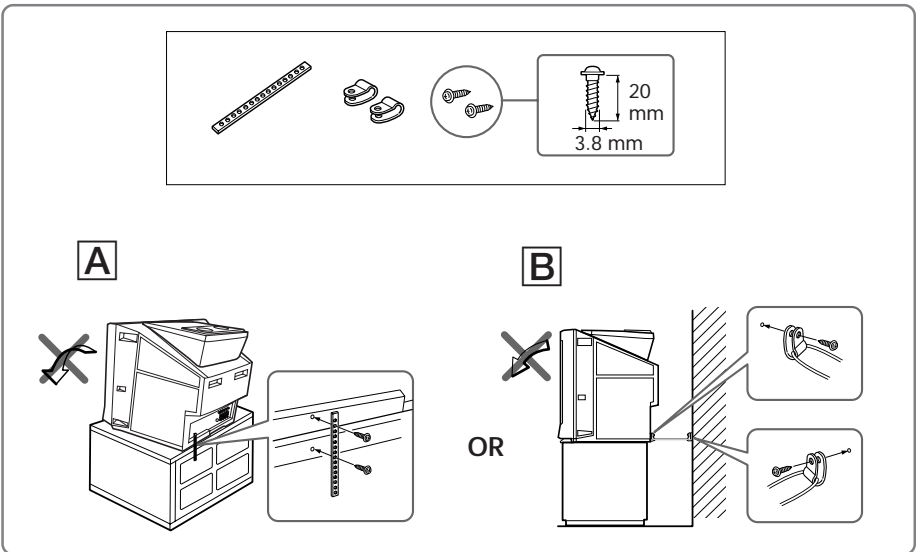

## Note

- Use only the supplied screws. Use of other screws may damage the TV.

# Watching the TV

This section explains various functions and operations available while watching the TV. Most operations can be done using the remote.

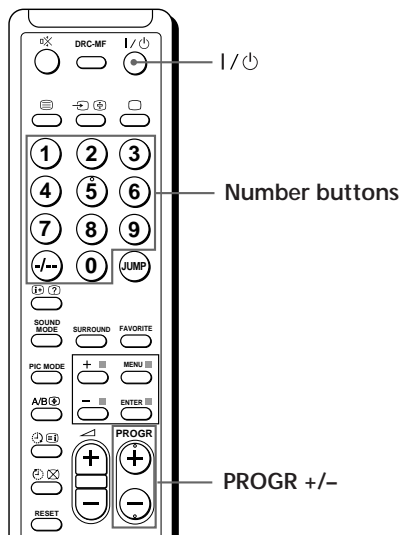
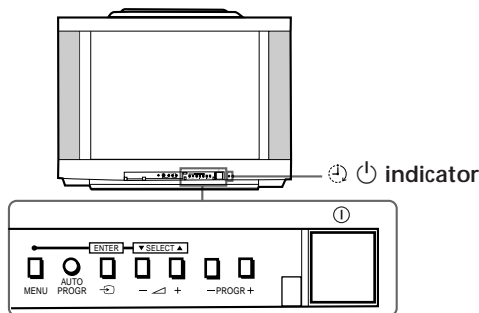

## 1 Press ① to turn on the TV.

When the TV is in standby mode (the ⏻ indicator on the TV is lit red), press I/⏻ on the remote or PROGR +/- on the TV.



## 2 Press PROGR +/- or the number buttons to select the TV channel.

For double digit numbers, press -/-, then the number (e.g., for 25, press -/-, then 2 and 5).

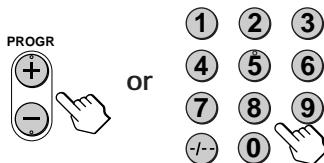

### Note

- When you turn on the TV, either the program number or video mode is displayed for approximately 40 seconds. The ECO MODE (ECO) icon will also appear if "ECO MODE" in the "SETUP" menu is set "ON" (see page 30).

## To select a TV program quickly

- Press and hold PROGR +/-.
- Release PROGR +/- when the desired program number appears.

### Note

- When you select a TV program quickly, the picture may be disrupted. This does not indicate a malfunction.

continued

## Watching the TV (continued)

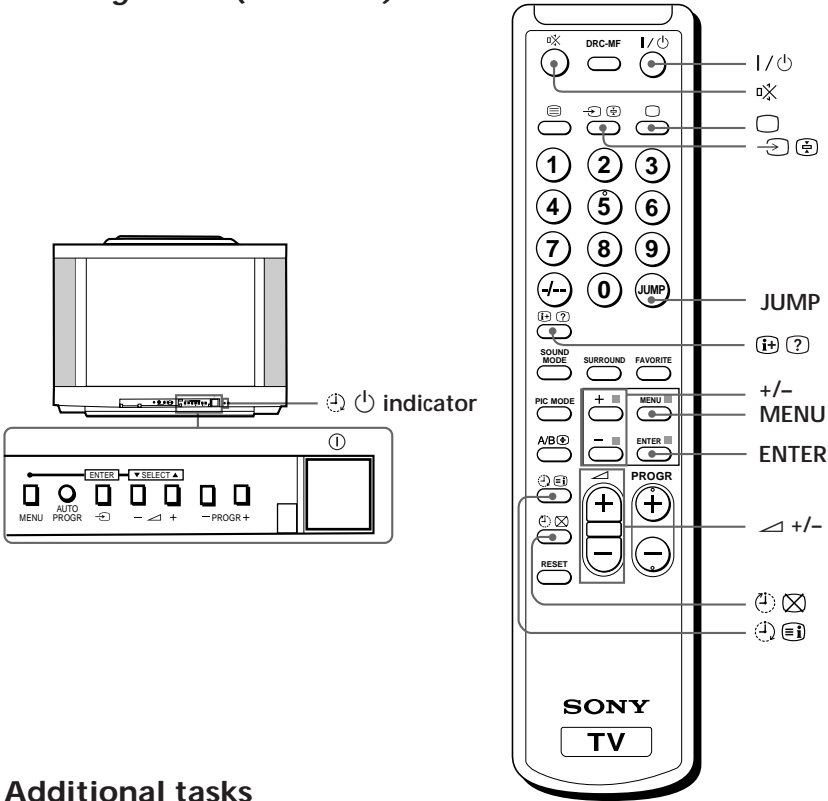

## Additional tasks

To	Press
Turn off temporarily	I/⏻. The ⏻ indicator on the TV lights up red.
Turn off completely	① on the TV.
Adjust the volume	⏮ +/-.
Mute the sound	⏻.
Watch the video input (VCR, camcorder, etc.)	⏮ (or ⏮ on the TV) to select "VIDEO 1", "VIDEO 2", "VIDEO 3", "VIDEO 4" or "DVD". To return to the TV screen, press □ (or ⏮ on the TV).
Jump back to the previous channel	JUMP.
Display the on-screen information*	i+.

\* Some picture/sound settings, and either the program number or video mode are displayed. The on-screen display for the picture/sound settings disappears after about 3 seconds.

## Changing the menu language

You can change the menu language as well as the on-screen language. For details on how to use the menu, see **Introducing the menu system** on page 23.

- 1** Press MENU.

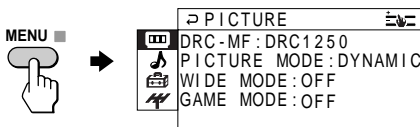

- 2** Press + or - to select , then press ENTER.

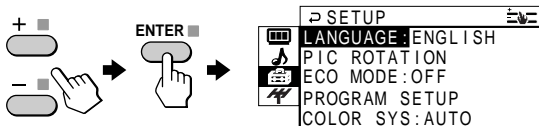

- 3** Make sure "LANGUAGE" is selected then press ENTER.

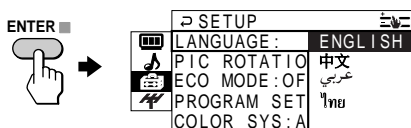

- 4** Press + or - to select the desired language (e.g., "中文"), then press ENTER.

The selected menu language appears.

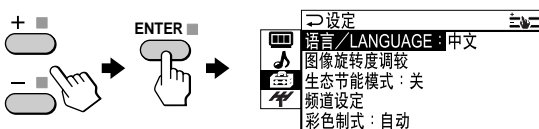

### To return to the normal screen

Press MENU.



continued

## Watching the TV (continued)

### Setting the Wake Up timer

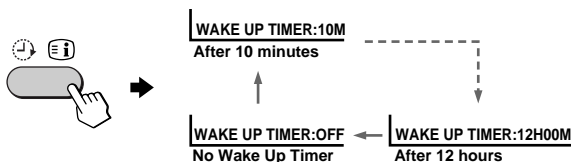
- 1 Press  until the desired period of time appears.  
The Wake Up timer starts immediately after you have set it.



- 2 Select the TV channel or video mode you want to wake up to.
- 3 Press , or set the Sleep timer if you want the TV to turn off automatically.  
The  indicator on the TV lights up orange.

### To cancel the Wake Up timer

Press  until “WAKE UP TIMER: OFF” appears, or turn off the TV’s main power.

#### Note

- If no buttons or controls are pressed for more than two hours after the TV is turned on using the Wake Up timer, the TV automatically goes into standby mode. To resume watching the TV, press any button or control on the TV or the remote.

### Setting the Sleep timer

- Press  until the desired period of time appears.  
The Sleep timer starts immediately after you have set it.

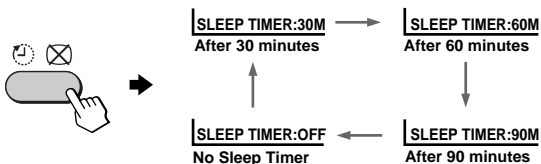

### To cancel the Sleep timer

Press  until “SLEEP TIMER: OFF” appears, or turn the TV off.

## Selecting the picture and sound modes

You can select picture and sound modes and adjust the setting to your preference in the “PERSONAL” option.

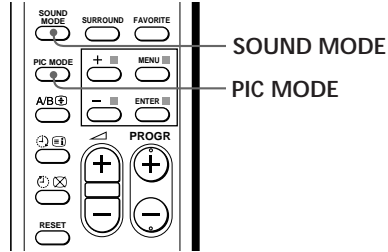

### Selecting the picture mode

Press PIC MODE repeatedly until the desired picture mode is selected.

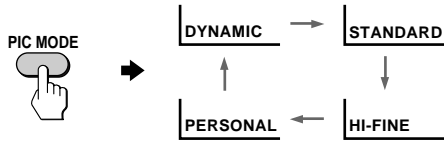

Select	To
“DYNAMIC”	receive high contrast pictures.
“STANDARD”	receive normal pictures.
“HI-FINE”	receive higher resolution pictures with mild contrast.
“PERSONAL”	receive the last adjusted picture setting from the “ADJUST” option in the “PICTURE” menu (see page 27).

### Selecting the sound mode

Press SOUND MODE repeatedly until the desired sound mode is selected.

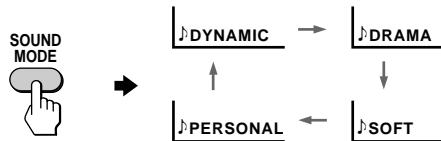

Select	To
“DYNAMIC”	listen to dynamic and clear sound that emphasizes both the low and high tones.
“DRAMA”	listen to sound that emphasizes voice and high tones.
“SOFT”	receive soft sound.
“PERSONAL”	receive the last adjusted sound setting from the “ADJUST” option in the “SOUND” menu (see page 29).

#### Tip

- You can also set the picture and sound modes using the menu (see **Changing the “PICTURE” setting** on page 26 and **Changing the “SOUND” setting** on page 28).

# Viewing higher quality pictures

## — “DRC-MF”

The Digital Reality Creation-Multi Function (DRC-MF) feature allows you to enjoy higher quality pictures on your TV. You can select “DRC1250” to watch super real (higher resolution) pictures, or “DRC PROGRESSIVE” to reduce any jittering on the screen if necessary.

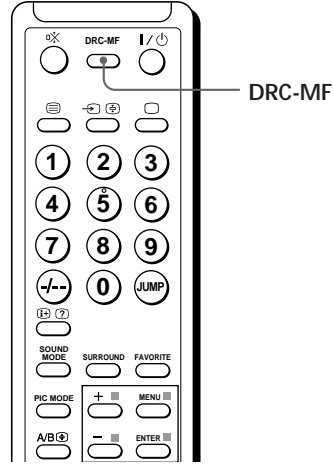

Press DRC-MF repeatedly until you receive the desired picture quality.



Select	To
“DRC1250”	select higher resolution pictures.
“DRC PROGRESSIVE”	reduce jitter of any small areas or scanning lines (e.g., letters or the edge of objects) on the screen.

### Tips

- You can also select the DRC-MF option using the menu (see **Changing the “PICTURE” setting** on page 26).
- When the broadcast signal is weak, you may see some dots or noise on the TV screen. To reduce this interference, display the “PICTURE” menu and select “ADJUST” in “PICTURE MODE”, then adjust “SHARP” to reduce the sharpness (see page 27).

### Note

- The DRC-MF mode is not selectable when the “GAME MODE” is turned “ON”.

The DRC-MF logo (  ) and “DRC-MF” are trademarks of Sony Corporation.



# Viewing your favorite channels

You can display and select six of your favorite channels directly from your TV screen.

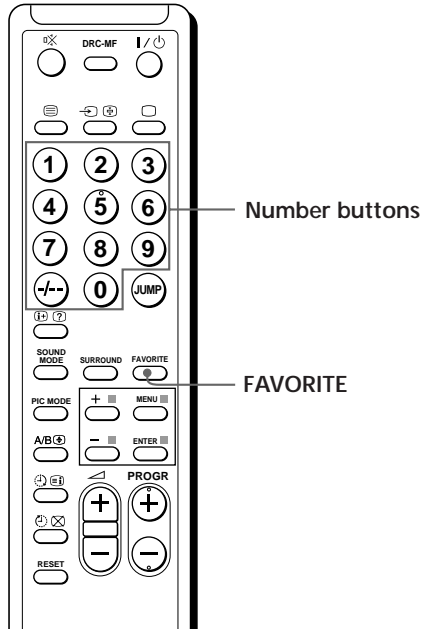

**1** Press FAVORITE.

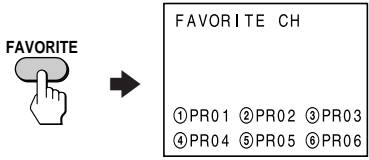

**2** Press the number button from 1 to 6 to select the desired channel.

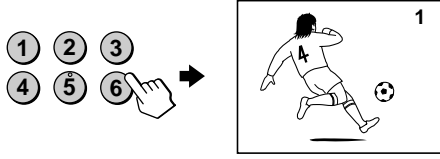

- Tip**
- To program your favorite channels, see **Adjusting each channel settings (PROGRAM SETUP)** on page 31.

# Listening with surround sound

The surround feature enables you to enjoy the sound effects of a concert hall or movie theater.

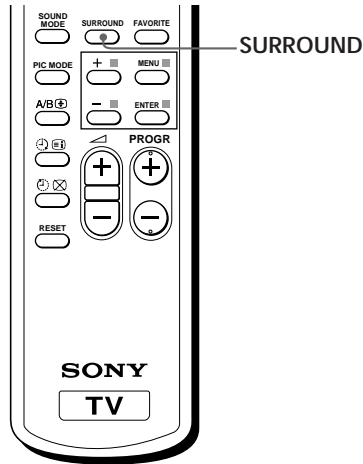

Press SURROUND repeatedly until you receive the desired surround sound.

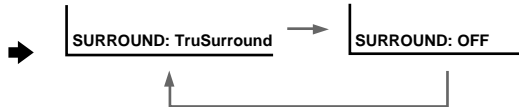

Select	To
“TruSurround”	listen to the surround sound that spreads out to the rear of a room.
“OFF”	turn off the surround sound.

**Tip**

- You can also select the surround option using the menu (see **Changing the “SOUND” setting** on page 28).

The surround of your TV is categorized as TruSurround.

**TruSurround™** is a trademark of SRS Labs, Inc. SRS and the SRS symbol are registered trademarks of SRS Labs, Inc. in the United States and selected foreign countries. SRS and TruSurround are incorporated under license from SRS Labs, Inc. and are protected under United States Patent Nos. 4,748,669 and 4,841,572 with numerous additional issued and pending foreign patents.

# Enjoying stereo or bilingual programs

You can enjoy stereo sound or bilingual programs of NICAM and A2 stereo systems.

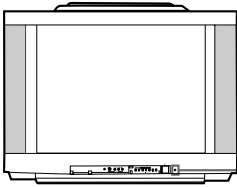

○ indicator

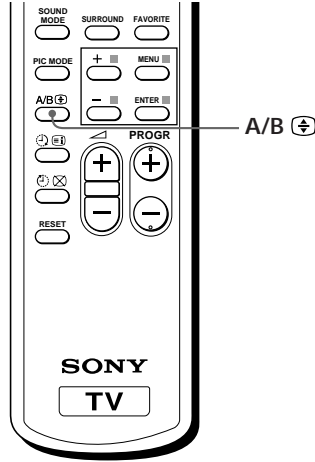

Press A/B repeatedly until you receive the sound you want.

The on-screen display changes to show the selected sound.

The ○ indicator on the TV lights up red when receiving any stereo or bilingual program.

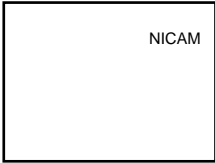

## When receiving a NICAM program

Broadcasting	On-screen display (Selected sound)
NICAM stereo	
NICAM bilingual	
NICAM monaural	

continued

## Enjoying stereo or bilingual programs (continued)

### When receiving an A2 program

Broadcasting	On-screen display (Selected sound)
A2 stereo	
A2 bilingual	

### Receiving area for NICAM and A2 programs

System	Receiving area
NICAM	Hong Kong, Singapore, New Zealand, Malaysia, Thailand, etc.
A2	Australia, Malaysia, Thailand, etc.

#### Notes

- If the signal is very weak, the sound becomes monaural automatically.
- If the stereo sound is noisy when receiving a NICAM program, select "MONO". The sound becomes monaural, but the noise is reduced.

### If the sound is distorted when receiving a monaural program through the $\square$ (antenna) terminal

Press A/B repeatedly until "MONO" appears on the screen.

To cancel the monaural sound setting, press A/B again until "AUTO" appears on the screen.



#### Notes













- The "MONO" or "AUTO" setting is memorized for each program position.
- You cannot receive a stereo broadcast signal when the TV is in the "MONO" setting. Normally, set the TV to "AUTO".



---





## Viewing teletext (continued)

### Additional Teletext tasks

To	Do this
display a Teletext page on the TV picture	Press  . Each time you press  , the screen changes as follows: Teletext → Teletext and TV → TV.
check the contents of a Teletext service	Press  . An overview of the Teletext contents, including page numbers, appears on the screen.
select a Teletext page	Press the number buttons to enter the three-digit page number of the desired Teletext page.* If you make a mistake, reenter the correct page number. To access the next or previous page, press PROGR +/-.
hold (pause) a Teletext display	Press  to display the symbol "  " at the top left corner of the screen. To resume normal Teletext viewing, press  or  .
reveal concealed information (e.g., an answer to a quiz)	Press  . To conceal the information, press the button again.
enlarge the Teletext display	Press  . Each time you press  , the Teletext display changes as follows: Enlarge upper half → Enlarge lower half → Normal size.
stand by for a Teletext page while watching a TV program	<ol style="list-style-type: none"><li>1 Enter the Teletext page number that you want to refer to, then press .</li><li>2 When the page number is displayed, press  to show the text.</li></ol>

\* You can also select a Teletext page that appears in the colored columns at the bottom of the screen using the corresponding color-coded buttons on the remote.

## Using FASTEXT

This feature allows you to quickly access a Teletext page that uses FASTEXT. When a FASTEXT program is broadcast, colored menus appear at the bottom of the screen. The color of each menu corresponds to the color-coded buttons on the remote (red , green , yellow , and blue ).



### To access a FASTEXT menu

Press the color-coded button on the remote corresponding to the menu you want. The menu page appears on the screen after a few seconds.

## Introducing the menu system

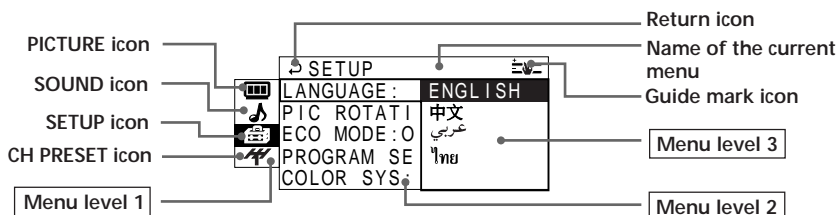

The MENU button lets you open a menu and change the settings of your TV. The following is an overview of the menu system.



Level 1	Level 2	Level 3/Function
"PICTURE" 	"DRC-MF"	Select the "DRC-MF" mode: "DRC1250" → "PROGRESSIVE"
	"PICTURE MODE"	Select the picture mode: "DYNAMIC" → "STANDARD" → "HI-FINE" → "PERSONAL" → "ADJUST"
	"ADJUST"	Adjust the "PERSONAL" option: "PICTURE" → "COLOR" → "BRIGHT" → "HUE" → "SHARP"
	"WIDE MODE"	Change the picture size.
	"GAME MODE"	Adjust the picture settings for video games.
"SOUND" 	"SOUND MODE"	Select the sound mode: "DYNAMIC" → "DRAMA" → "SOFT" → "PERSONAL" → "ADJUST"
	"ADJUST"	Adjust the "PERSONAL" option: "BASS" → "TREBLE" → "BALANCE" → "BBE"*
	"SURROUND"	Select the "SURROUND" mode: "TruSurround" → "OFF"
	"INTELLIGENT VOL"	Adjust volume automatically.

continued

## Introducing the menu system (continued)

Level 1	Level 2	Level 3/Function
"SETUP" 	"LANGUAGE"	Change the menu language: "ENGLISH" → "中文" (Chinese) → "عربي" (Arabic) → "ไทย" (Thai)
	"PIC ROTATION"	Adjust the picture position.
	"ECO MODE"	Reduce power consumption of your TV.
	"PROGRAM SETUP"	Adjust each channel settings.
	"COLOR SYS"	Select the color system: "AUTO" → "PAL" → "SECAM" → "NTSC3.58" → "NTSC4.43"
"CH PRESET" 	"AUTO PROGRAM"	Preset channels automatically.
	"MANUAL PROGRAM"	Preset channels manually.
	"TV SYS"	Select the TV system: "B/G" → "I" → "D/K" → "M"

\* The BBE is manufactured by Sony Corporation under license from BBE Sound, Inc. It is covered by U.S. Patent No. 4,638,258 and No. 4,482,866. The word "BBE" and the BBE symbol are the trademarks of BBE Sound, Inc.



# How to use the menu

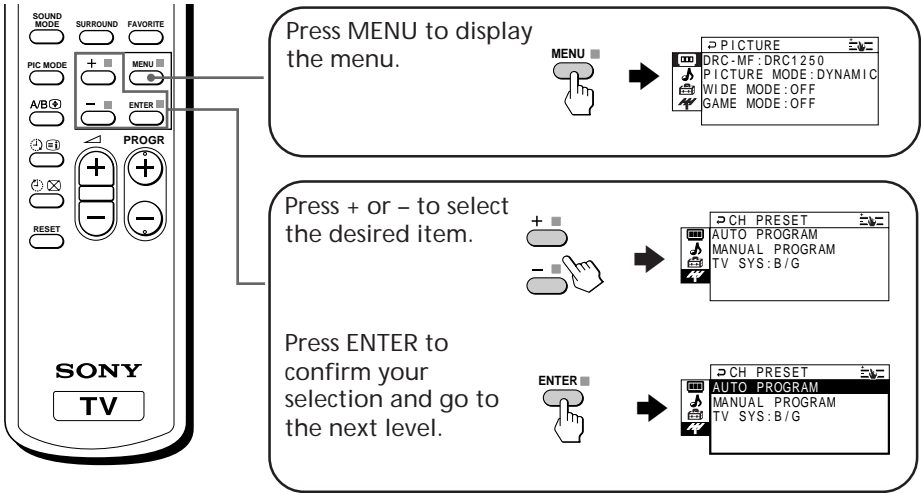

## Other menu operations

To	Press
Adjust the setting value	+ or -.
Return to the previous menu level	ENTER.
Cancel the menu	MENU.

### Tips

- If you want to exit from Menu level 2 to Menu level 1, press + or - until the return icon (↶) is highlighted, then press ENTER.
- Some of the menu items can be operated directly using the remote buttons.
- The MENU, ENTER, and SELECT ▼/▲ buttons on the TV can also be used for the operations above.

### Front of TV

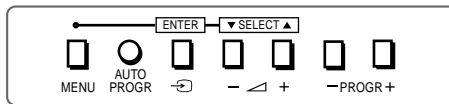

### Note

- If more than 60 seconds elapse between entries, the menu screen automatically disappears.

# Changing the “PICTURE” setting

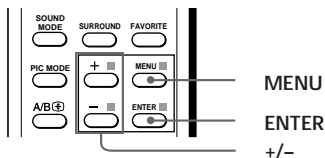

The “PICTURE” menu allows you to adjust the picture settings.

**1** Press MENU.

**2** Make sure the “PICTURE” icon (📺) is selected, then press ENTER.

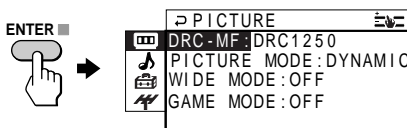

**3** Press + or – to select the desired item (e.g., “DRC-MF”), then press ENTER.

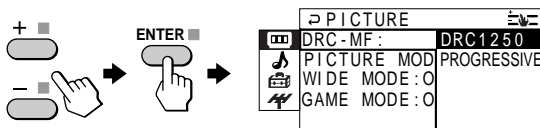

Select	To
“DRC-MF”	choose either “DRC1250” or “PROGRESSIVE”.
“PICTURE MODE”	choose either “DYNAMIC”, “STANDARD”, “HI-FINE”, “PERSONAL”*, or “ADJUST”.
“WIDE MODE”	change the picture size when receiving wide-mode (16:9) picture signal.  Press + or – to select “ON”, then press ENTER. To cancel, select “OFF”, then press ENTER.
“GAME MODE”	adjust the picture setting that is suitable to view video games.  Press + or – to select “ON”, then press ENTER. To cancel, select “OFF”, then press ENTER.

\* When the “PERSONAL” mode is selected, you can receive the last adjusted picture settings from the “ADJUST” option (see page 27).

## Notes

- For details on the options under “DRC-MF” and “PICTURE MODE”, see pages 16 and 15 respectively.
- “GAME MODE” is available only when receiving signals through the 📺 (video input), 📺 (S video input), or 📺 (component video input) jacks at the front and rear of your TV.

## To return to the normal screen

Press MENU.

## Adjusting the “ADJUST” items under “PICTURE MODE”

- 1** Press + or – to select the desired item (e.g., “COLOR”), then press ENTER.

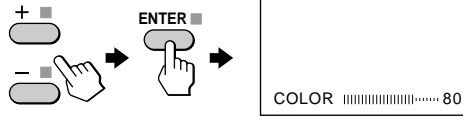

- 2** Adjust the value according to the following table, then press ENTER.

For	Press – to	Press + to
“PICTURE”	decrease picture contrast	increase picture contrast
“COLOR”	decrease color intensity	increase color intensity
“BRIGHT”	darken the picture	brighten the picture
“HUE”*	increase red picture tones	increase green picture tones
“SHARP”	soften the picture	sharpen the picture

\* You can adjust “HUE” for the NTSC color system only.

- 3** Repeat the above steps to adjust other items.  
The adjusted settings will be received when you select “PERSONAL”.

**Tip**

- For details on the menu system and how to use the menu, refer to **Introducing the menu system** on page 23.

# Changing the "SOUND" setting

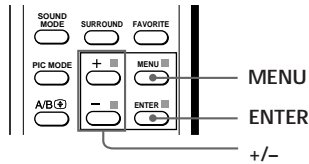

The "SOUND" menu allows you to adjust the sound settings.

**1** Press MENU.

**2** Press + or - to select the "SOUND" icon (🔊), then press ENTER.

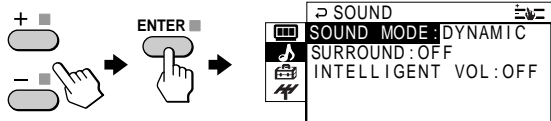

**3** Press + or - to select the desired item (e.g., "SOUND MODE"), then press ENTER.

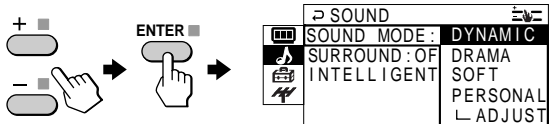

Select	To
"SOUND MODE"	choose either "DYNAMIC", "DRAMA", "SOFT", "PERSONAL"*, or "ADJUST".
"SURROUND"	choose either "TruSurround" or "OFF".
"INTELLIGENT VOL"	adjust the volume of all TV programs and video inputs automatically.  Press + or - to select "ON", then press ENTER. To cancel, select "OFF", then press ENTER.

\* When the "PERSONAL" mode is selected, you can receive the last adjusted sound settings from the "ADJUST" option (see page 29).

## Note

- For details on the options under "SOUND MODE" and "SURROUND", see pages 15 and 18 respectively.

## To return to the normal screen

Press MENU.

## Adjusting the “ADJUST” items under “SOUND MODE”

- 1** Press + or – to select the desired item (e.g., “BALANCE”), then press ENTER.

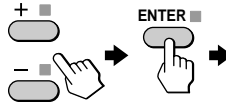

BALANCE  00

- 2** Adjust the value according to the following table, then press ENTER .

For	Press – to	Press + to
“BASS”	decrease the bass	increase the bass.
“TREBLE”	decrease the treble	increase the treble.
“BALANCE”	increase the left speaker’s volume	increase the right speaker’s volume.
“BBE”	select “HIGH” for higher enhancement of sound clarity; select “LOW” for lower enhancement of sound clarity; select “OFF” to turn off the BBE sound.	

- 3** Repeat the above steps to adjust other items.  
The adjusted settings will be received when you select “PERSONAL”.

**Tip**

- For details on the menu system and how to use the menu, refer to **Introducing the menu system** on page 23.

# Changing the "SETUP" setting

The "SETUP" menu allows you to change the menu language, adjust the picture position, reduce your TV power consumption, setup your programs and select the color system.

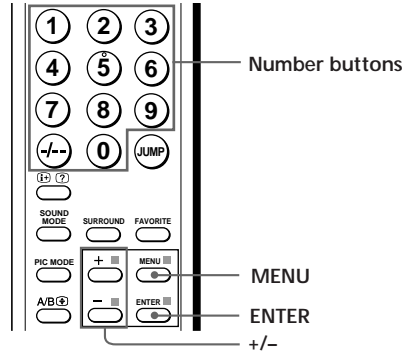

**1** Press MENU.

**2** Press + or - to select the "SETUP" icon (🔧), then press ENTER.

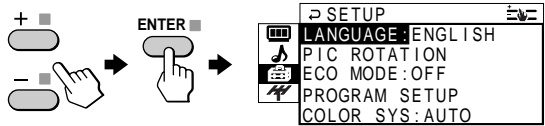

**3** Press + or - to select the desired item (e.g., "COLOR SYS"), then press ENTER.

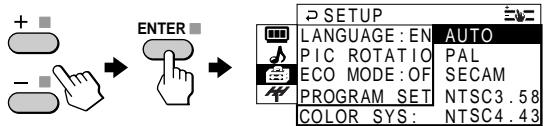

Select	To
"LANGUAGE"	change the menu language (see <b>Changing the menu language</b> on page 13).
"PIC ROTATION"	adjust the picture position when it is not aligned with the TV screen. Press + or - to adjust the picture position, then press ENTER.
"ECO MODE"	reduce power consumption of your TV to save energy. Press + or - to select "ON", then press ENTER. To cancel, select "OFF", then press ENTER.
"PROGRAM SETUP"	adjust each channel settings (see <b>Adjusting each channel settings (PROGRAM SETUP)</b> on page 31).
"COLOR SYS"	select the color system. Normally, set this to "AUTO".

## To return to the normal screen

Press MENU.

## Adjusting each channel settings (PROGRAM SETUP)

**1** Select "PROGRAM SETUP" from the "SETUP" menu.

**2** Select "PR" and press ENTER. Press + or - to select the desired channel you want to adjust, then press ENTER.

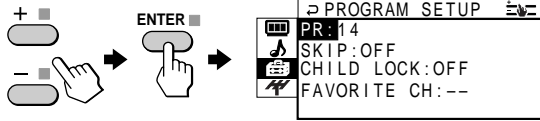

**3** Press + or - to select the desired item (e.g., "SKIP"), then press ENTER.

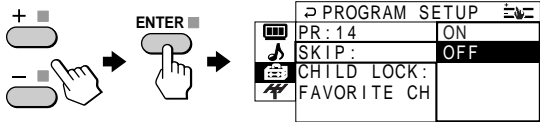

Select	To
"PR"	select the desired channel.
"SKIP"	skip unwanted or unused program number. Press + or - to select "ON", then press ENTER. To cancel, select "OFF", then press ENTER.
"CHILD LOCK"	prevent children from watching this selected channel. Press + or - to select "ON", then press ENTER. The lock symbol (🔒) appears on the screen. To cancel, select "OFF", then press ENTER. If you preset a locked channel, that channel will be unlocked automatically.
"FAVORITE CH"	program six channels for direct selection. Press + or - to select one of the six favorite channel numbers (if you decide not to make any changes, select "▷"), then press ENTER. To view the selected favorite channel, refer page 17.

**4** To continue adjusting other channels, press + or - to select "PR", then repeat step 2 and 3.

### To return to the normal screen

Press MENU.

# Changing the Channel Preset ("CH PRESET") setting

The "CH PRESET" menu allows you to adjust the setup of your TV. For example, you can manually tune in a channel with a weak signal that fails to be tuned in by automatic presetting.

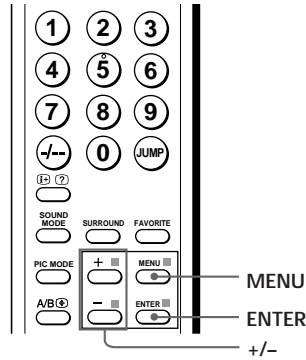

**1** Press MENU.

**2** Press + or - to select the "CH PRESET" icon (⚡), then press ENTER.

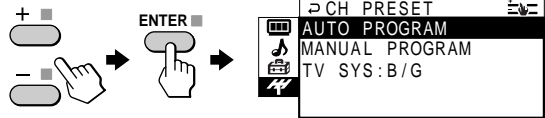

**3** Press + or - to select the desired item (e.g., "AUTO PROGRAM"), then press ENTER.

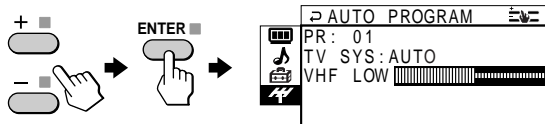

Select	To
"AUTO PROGRAM"	preset channels automatically.
"MANUAL PROGRAM"	preset channels manually. See <b>Presetting channels manually</b> on page 33.
"TV SYS"	select the TV system. Press + or - to select either "B/G", "I", "D/K" or "M", then press ENTER.

## To return to the normal screen

Press MENU.

### Tip

- For details on the menu system and how to use the menu, refer to **Introducing the menu system** on page 23.



## Presetting channels manually

**1** After selecting “MANUAL PROGRAM”, select the program number to which you want to preset a channel.

(1) Make sure “PR” is selected, then press ENTER.

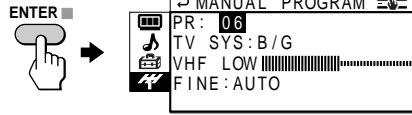

(2) Press + or - until the program number you want to preset (e.g., program number “10”) appears on the menu, then press ENTER.

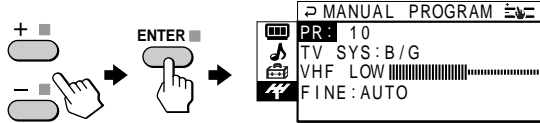

### Tip

- You can also select the program number with the PROG +/- or number buttons.

**2** Select the desired channel.

(1) Press + or - to select either “VHF LOW”, “VHF HIGH”, or “UHF”, then press ENTER.

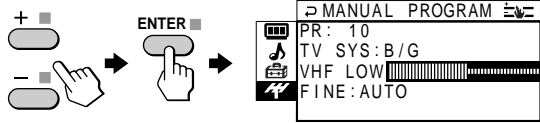

(2) Press + or - until the desired channel's broadcast appears on the TV screen, then press ENTER.

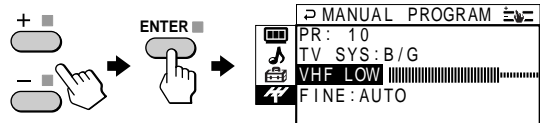

**3** If the sound of the desired channel is abnormal, select the appropriate TV system.

(1) Press + or - to select “TV SYS”, then press ENTER.

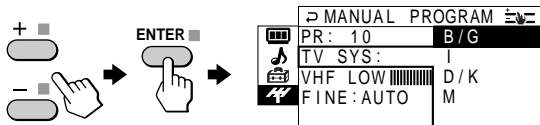

(2) Press + or - until the sound becomes normal, then press ENTER.

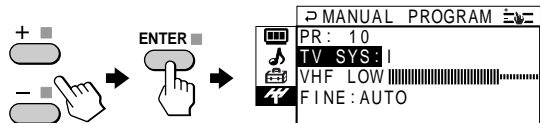

continued

## Changing the "CH PRESET" setting (continued)

**4** If you are not satisfied with the picture and sound quality, you may be able to improve them by using the "FINE" tuning feature.

- (1) Press + or - to select "FINE", then press ENTER.

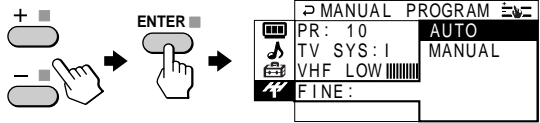

- (2) Press + or - to select "MANUAL", then press ENTER.

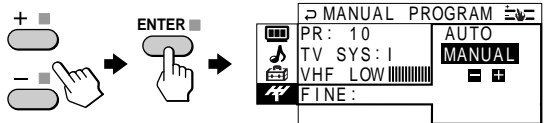

- (3) Press + or - until the picture and sound quality are optimal, then press ENTER. The + or - icon on the menu flashes while tuning.

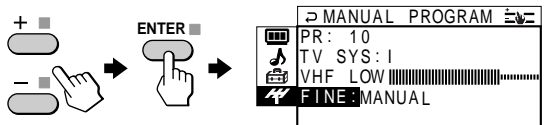

### To return to the normal screen

Press MENU.

#### Notes

- The TV system ("TV SYS") and fine tuning ("FINE") settings are memorized for each program number.
- If you preset a locked channel ("CHILD LOCK"), that channel will be unlocked automatically (see page 31).

# Self-diagnosis function

Your TV is equipped with a self-diagnosis function. If there is a problem with your TV, the ⏻ (standby) indicator flashes red. The number of times the ⏻ indicator flashes indicates the possible causes.

Front of TV

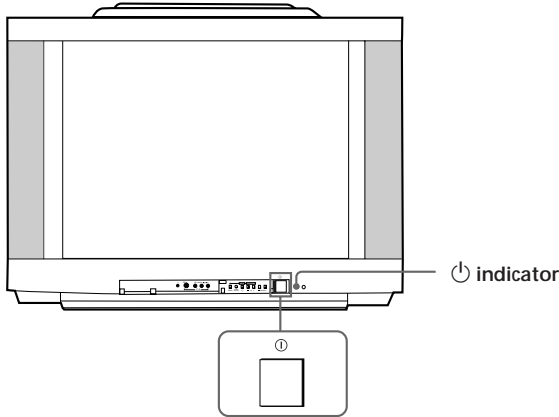

- 1** Check that the ⏻ indicator flashes red a number of times between 3-second intervals.
- 2** Count the number of times the ⏻ indicator flashes.
- 3** Press ⏻ (main power) to turn off your TV.
- 4** Inform your nearest Sony service center about the number of times the ⏻ indicator flashed.  
Be sure to note the model name and serial number located on the rear of your TV.

# Troubleshooting Shortcuts

For better viewing, please check the following connections.

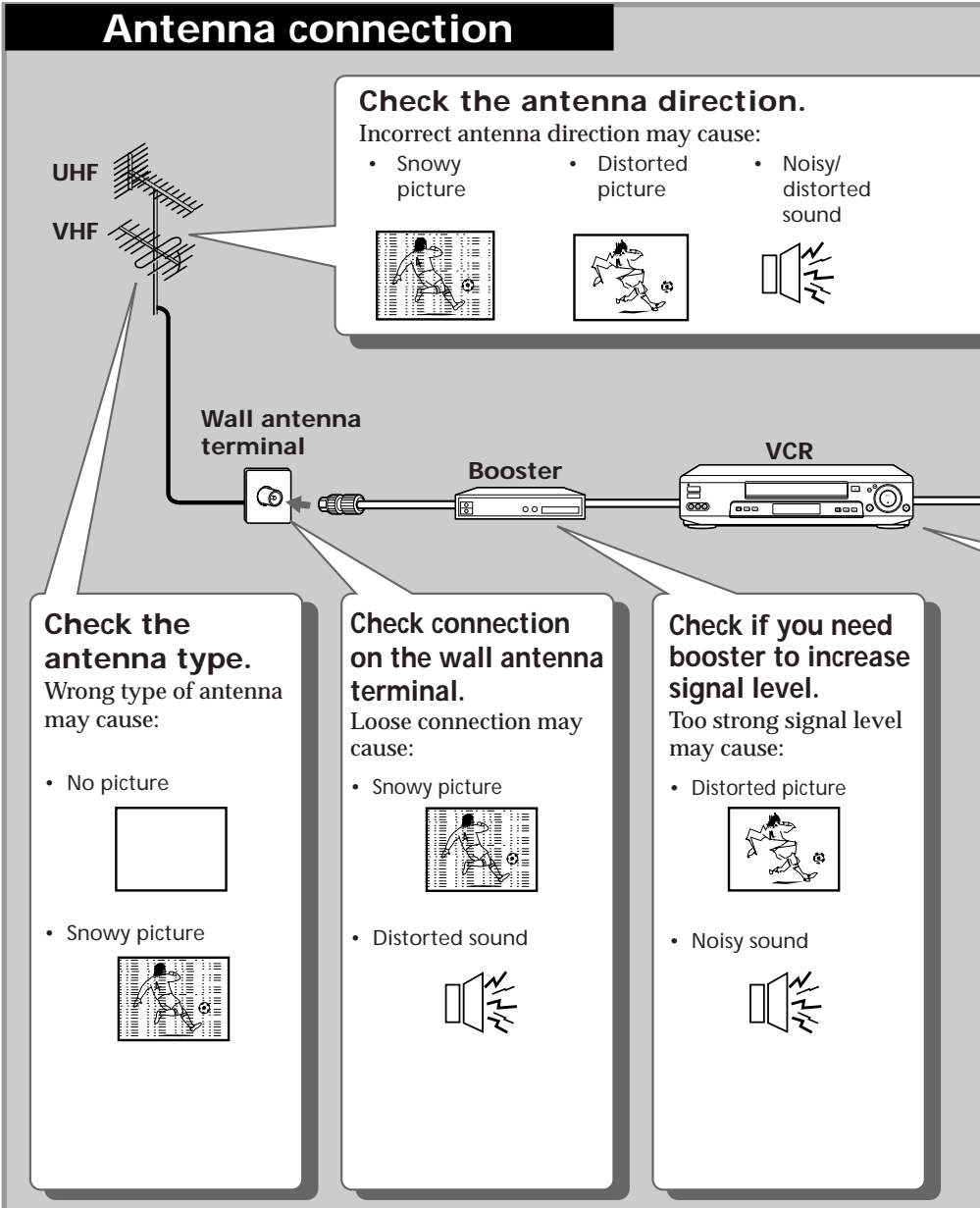

- Double image picture



- Missing Teletext characters

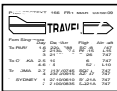

Connection to TV

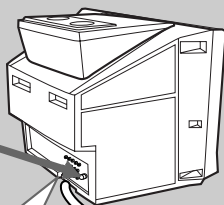

**Check connection on the VCR and on the TV.**

Loose connection may cause:

- Snowy picture

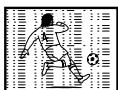

- Distorted sound



- No picture

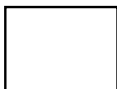

## AC Connection

**Check connection on the AC socket.**

Loose connection may cause:

- no power
- no picture with no sound



For more information, please see **Troubleshooting** on page 38 or consult your dealer for guidance.

# Troubleshooting

If you have any problem while viewing your TV, you can either use the Reset function or check the Troubleshooting guide below. If the problem persists, contact your Sony dealer.





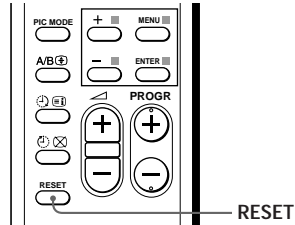

## Reset function



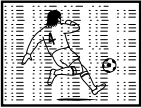



Press the RESET button on your remote control. Your TV will go blank for about half a second then the picture will reappear with “RESET” displayed on your TV screen for about 10 seconds.

Pressing RESET will set your TV to the factory setting, but certain problems may be solved.





## Troubleshooting guide

Symptom	Possible cause	Solutions	Page
Snowy picture 	<ul style="list-style-type: none"> <li>The connection is loose or the cable is damaged.</li> <li>Channel presetting is inappropriate or incomplete.</li> </ul>	<ul style="list-style-type: none"> <li>Check the antenna cable and connection on the TV, VCR and at the wall.</li> <li>Display the “CH PRESET” menu and select “MANUAL PROGRAM” to preset the channel again.</li> </ul>	4  33
Noisy sound 	<ul style="list-style-type: none"> <li>The antenna type is inappropriate.</li> <li>The antenna direction needs adjustment.</li> <li>Signal transmission is low.</li> </ul>	<ul style="list-style-type: none"> <li>Check the antenna type (VHF/UHF). Contact a Sony dealer for advice.</li> <li>Adjust the antenna direction. Contact a Sony dealer for advice.</li> <li>Try using a booster.</li> </ul>	– – –
Distorted picture 	<ul style="list-style-type: none"> <li>Broadcast signals are too strong.</li> </ul>	<ul style="list-style-type: none"> <li>Turn off or disconnect the booster if it is in use.</li> </ul>	–
Noisy sound 			
Good picture 	<ul style="list-style-type: none"> <li>The TV system setting or channel presetting is inappropriate or incomplete.</li> </ul>	<ul style="list-style-type: none"> <li>If the sound of all the channels are noisy, display the “CH PRESET” menu and select “AUTO PROGRAM” to preset the channels again.</li> <li>If the sound of some channels is noisy, select the channel, then display the “CH PRESET” menu and select the appropriate TV system (“TV SYS”).</li> </ul>	32  33
Noisy sound 			

Symptom	Possible cause	Solutions	Page
No picture 	<ul style="list-style-type: none"> <li>The power cord, antenna or VCR is not connected.</li> </ul>	<ul style="list-style-type: none"> <li>Check the power cord, antenna and the VCR connections.</li> </ul>	4
	<ul style="list-style-type: none"> <li>The TV is not turned on.</li> </ul>	<ul style="list-style-type: none"> <li>Press I/⏻ (power).</li> <li>Press Ⓛ (main power) on the TV to turn off the TV for about five seconds, then turn it on again.</li> </ul>	11 12
No sound 	<ul style="list-style-type: none"> <li>The volume level is too low.</li> </ul>	<ul style="list-style-type: none"> <li>Press ▲ + to increase the volume level.</li> </ul>	12
	<ul style="list-style-type: none"> <li>The sound is muted.</li> </ul>	<ul style="list-style-type: none"> <li>Press ⓧ to cancel the muting.</li> </ul>	12
	<ul style="list-style-type: none"> <li>The broadcast signal has a transmission problem.</li> </ul>	<ul style="list-style-type: none"> <li>Press A/B until a better sound is heard.</li> </ul>	19
Good picture 	<ul style="list-style-type: none"> <li>The volume level is too low.</li> </ul>	<ul style="list-style-type: none"> <li>Press ▲ + to increase the volume level.</li> </ul>	12
	<ul style="list-style-type: none"> <li>The sound is muted.</li> </ul>	<ul style="list-style-type: none"> <li>Press ⓧ to cancel the muting.</li> </ul>	12
No sound 	<ul style="list-style-type: none"> <li>The broadcast signal has a transmission problem.</li> </ul>	<ul style="list-style-type: none"> <li>Press A/B until a better sound is heard.</li> </ul>	19
	<ul style="list-style-type: none"> <li>There is local interference from cars, neon signs, hair dryers, power generators, etc.</li> </ul>	<ul style="list-style-type: none"> <li>Do not use a hair dryer or other equipment near the TV.</li> <li>Adjust the antenna direction for minimum interference. Contact a Sony dealer for advice.</li> </ul>	- -
Dotted lines or stripes 	<ul style="list-style-type: none"> <li>Broadcast signals are reflected by nearby mountains or buildings.</li> </ul>	<ul style="list-style-type: none"> <li>Use a highly directional antenna.</li> <li>Use the fine tuning ("FINE") function.</li> </ul>	- 34
	<ul style="list-style-type: none"> <li>The antenna direction needs adjustment.</li> </ul>	<ul style="list-style-type: none"> <li>Adjust the antenna direction. Contact a Sony dealer for advice.</li> </ul>	-
	<ul style="list-style-type: none"> <li>Use of a booster is inappropriate.</li> </ul>	<ul style="list-style-type: none"> <li>Turn off or disconnect the booster if it is in use.</li> </ul>	-
Double images or "ghosts" 	<ul style="list-style-type: none"> <li>The color level setting is too low.</li> </ul>	<ul style="list-style-type: none"> <li>Display the "PICTURE" menu and select "ADJUST" of "PICTURE MODE", then adjust the "COLOR" level.</li> </ul>	27
	<ul style="list-style-type: none"> <li>The color system setting is inappropriate.</li> </ul>	<ul style="list-style-type: none"> <li>Display the "SETUP" menu and check the color system ("COLOR SYS") setting (usually set this to "AUTO").</li> </ul>	30
	<ul style="list-style-type: none"> <li>The antenna direction needs adjustment.</li> </ul>	<ul style="list-style-type: none"> <li>Adjust the antenna direction. Contact a Sony dealer for advice.</li> </ul>	-
No color 	<ul style="list-style-type: none"> <li>The color level setting is too low.</li> </ul>	<ul style="list-style-type: none"> <li>Display the "PICTURE" menu and select "ADJUST" of "PICTURE MODE", then adjust the "COLOR" level.</li> </ul>	27
<ul style="list-style-type: none"> <li>The color system setting is inappropriate.</li> </ul>	<ul style="list-style-type: none"> <li>Display the "SETUP" menu and check the color system ("COLOR SYS") setting (usually set this to "AUTO").</li> </ul>	<ul style="list-style-type: none"> <li>Adjust the antenna direction. Contact a Sony dealer for advice.</li> </ul>	30 -
<ul style="list-style-type: none"> <li>The antenna direction needs adjustment.</li> </ul>	<ul style="list-style-type: none"> <li>Adjust the antenna direction. Contact a Sony dealer for advice.</li> </ul>	-	-

continued

## Troubleshooting (continued)

Symptom	Possible cause	Solutions	Page
Abnormal color patches 	<ul style="list-style-type: none"> <li>The magnetic disturbance from external speakers or other equipment, or the direction of the earth's magnetic field may affect the TV.</li> </ul>	<ul style="list-style-type: none"> <li>Keep external speakers or other equipment away from the TV. Do not move the TV while the TV is turned on. Press <math>\text{\textcircled{1}}</math> (main power) on the TV to turn off the TV for about five minutes, then turn it on again.</li> </ul>	–
TV cannot receive stereo broadcast signal.	<ul style="list-style-type: none"> <li>The stereo reception setting is inappropriate.</li> </ul>	<ul style="list-style-type: none"> <li>Press A/B until "AUTO" appears on the screen.</li> </ul>	19
Stereo broadcast sound switches on and off or is distorted.  <b>OR</b>  The sound switches between stereo and monaural frequently.	<ul style="list-style-type: none"> <li>The connection is loose or the cable is damaged.</li> <li>The antenna direction needs adjustment.</li> <li>The broadcast signal has a transmission problem.</li> </ul>	<ul style="list-style-type: none"> <li>Check the antenna cable and connection on the TV, VCR and on the wall.</li> <li>Adjust the antenna direction. Contact a Sony dealer for advice.</li> <li>Press A/B until a better sound is heard.</li> </ul>	4 – 19
"100" appears at the top of the screen and there is no Teletext display.	<ul style="list-style-type: none"> <li>The channel carries no Teletext broadcast.</li> </ul>	—	21
Teletext display is incomplete (snowy picture or double images).	<ul style="list-style-type: none"> <li>Connection is loose or the cable is damaged.</li> <li>The antenna direction is inappropriate.</li> <li>Signal transmission is too low.</li> </ul>	<ul style="list-style-type: none"> <li>Check the antenna cable and connection on the TV, VCR, and at the wall.</li> <li>Adjust the antenna direction. Contact a Sony dealer for advice.</li> <li>Try using a booster.</li> <li>Use the fine tuning ("FINE") function.</li> </ul>	4 – – 34
Picture slant 	<ul style="list-style-type: none"> <li>The magnetic disturbance from external speakers or other equipment, or the direction of the earth's magnetic field may affect the TV.</li> </ul>	<ul style="list-style-type: none"> <li>Keep external speakers or other electrical equipment away from the TV.</li> <li>Display the "SETUP" menu and adjust "PIC ROTATION" so that the picture is aligned to the TV screen.</li> </ul>	– 30



Symptom	Possible cause	Solutions	Page
Lines moving across the TV screen.	<ul style="list-style-type: none"> <li>There is interference from external sources, e.g., heavy machineries, nearby broadcast station.</li> </ul>	<ul style="list-style-type: none"> <li>Use the fine tuning (“FINE”) function.</li> </ul>	34
The  indicator on your TV flashes red a number of times between 3-second intervals.	<ul style="list-style-type: none"> <li>Your TV may need servicing.</li> </ul>	<ul style="list-style-type: none"> <li>Contact your nearest Sony service center.</li> </ul>	35
Cannot play shooting games.	<ul style="list-style-type: none"> <li>Some shooting games which involve pointing a light beam at the TV screen with an electronic gun or rifle cannot be used with your TV. For detail, see the instruction manual supplied with the video game software.</li> </ul>	—	—
TV cabinet creaks.	<ul style="list-style-type: none"> <li>Changes in room temperature sometimes make the TV cabinet expand or contract, causing a noise. This does not indicate a malfunction.</li> </ul>	—	—
A small “boom” sound is heard when the TV is turned on.	<ul style="list-style-type: none"> <li>The TV’s demagnetizing function is working. This does not indicate a malfunction.</li> </ul>	—	—

# Overview of controls

## TV front panel

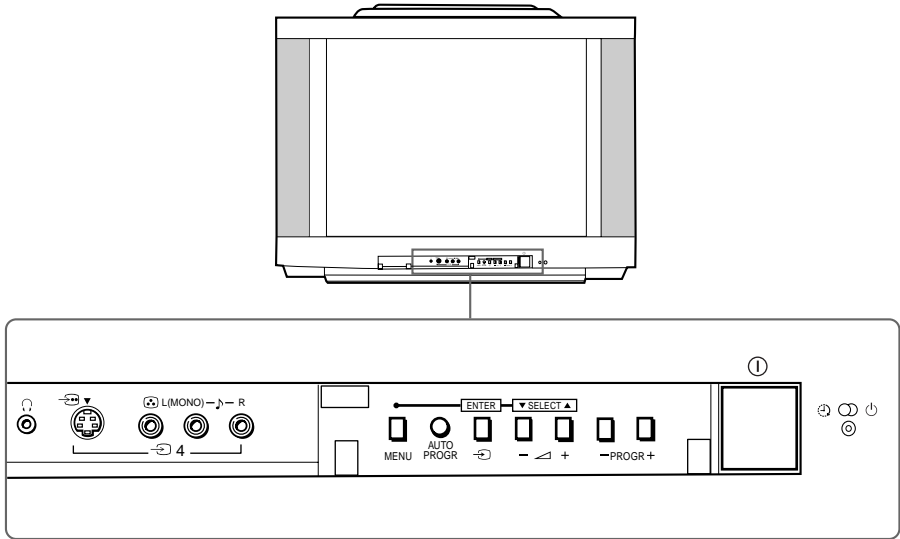

Button	Function	Page
AUTO PROGR	Preset channels automatically.	5
①	Turn off completely or turn on the TV.	11
PROGR +/-	Select program number.	11
⏻	Standby indicator.	11
🔊 +/-	Adjust volume.	12
📺	Select TV or video input.	12
⌚	Wake Up indicator.	14
🔊	Stereo/Bilingual indicator.	19
MENU	Display the menu.	25
🎧	Headphone jack.	-

## Remote control

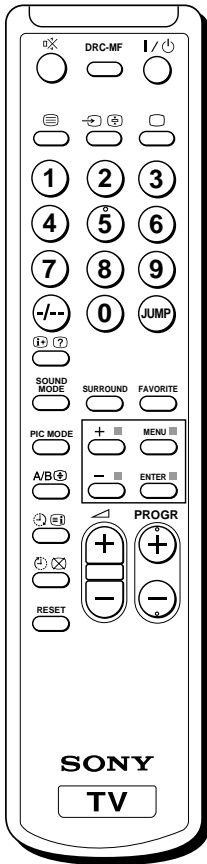





The names/symbols of buttons on the remote are indicated in different colors to represent the available functions.

Label color	Button function
White	For general TV operations
Green	For Teletext operations

Button	Function	Page
I/⏻	Turn off temporarily or turn on the TV.	11
PROGR +/-	Select program number.	11
0 - 9, -/--	Input numbers.	11
ⓘ	Display on-screen information.	12
⊘	Mute the sound.	12
□	Display the TV program.	12
↶	Select TV or video input.	12
↔ +/-	Adjust volume.	12
JUMP	Jump to previous channel.	12
Timer operation		
⌚	Set TV to turn on automatically.	14
⌚	Set TV to turn off automatically.	14
SOUND MODE	Select sound mode.	15
PIC MODE	Select picture mode.	15
DRC-MF	Select DRC-MF mode.	16
Favorite Channel operations		
FAVORITE	Display favorite channels.	17
1 - 6	Select desired channel.	17
SURROUND	Select surround mode.	18
Stereo/bilingual operations		
A/B	Select stereo/bilingual mode.	19
Teletext operations		
☰	Display Teletext broadcast.	21
ⓘ	Display Teletext service contents.	22
⊞	Stop Teletext display from scrolling.	22
?	Reveal concealed information.	22
⊕	Enlarge the Teletext display.	22
⊗	Show TV screen while waiting for Teletext page.	22
0 - 9	Input Teletext page number.	22
PROGR +/-	Display the next or previous page.	22
■ (red, green, yellow, blue)	Access a FASTEXT menu.	22
Menu operations		
MENU	Display the menu.	25
+, -	Select and adjust items.	25
ENTER	Confirm selected items.	25
RESET	Set TV to factory setting.	38

# Specifications

	KV-EX29M65	Note
Power requirements	220-240 V AC, 50/60 Hz	
Power consumption (W)	Indicated on the rear of the TV	
Television system	B/G, I, D/K, M	
Color system	PAL, PAL 60, SECAM, NTSC4.43, NTSC3.58	
Stereo/Bilingual system	NICAM Stereo/Bilingual B/G, I, D/K; A2 Stereo/Bilingual B/G	
Teletext language	English, Arabic, French	
Channel coverage B/G	VHF : E2 to E12 / UHF : E21 to E69 / CATV : S01 to S03, S1 to S41	
I	UHF : B21 to B68 / CATV : S01 to S03, S1 to S41	
D/K	VHF : C1 to C12, R1 to R12 / UHF : C13 to C57, R21 to R60 / CATV : S01 to S03, S1 to S41, Z1 to Z39	
M	VHF : A2 to A13 / UHF : A14 to A79/ CATV : A-8 to A-2, A to W+4, W+6 to W+84	
⌚(Antenna)	75-ohm external terminal	
Audio output (Speaker)	6W + 6W	
3D WOOFER	15W	
Number of terminal		
 (Video)	Input: 4    Output: 1    Phono jacks; 1 Vp-p, 75 ohms	
 (Audio)	Input: 4    Output: 1    Phono jacks; 500 mVrms	
 (S Video)	Input: 2 Y: 1 Vp-p, 75 ohms, unbalanced, sync negative C: 0.286 Vp-p, 75 ohms	
 (Component Video)	Input: 1 Phono jacks; Y: 1 Vp-p, 75 ohms, sync negative CB: 0.7 Vp-p, 75 ohms CR: 0.7 Vp-p, 75 ohms Audio: 500 mVrms	
 (Headphone)	Output: 1    Stereo minijack	
Picture tube	29 in.	
Tube size (cm)	72	Measured diagonally
Screen size (cm)	68	Measured diagonally
Dimensions (w/h/d, mm)	772 × 603 × 516	
Mass (kg)	56	

Design and specifications are subject to change without notice.