

Compact Disc Compact Player

Operating Instructions

About area code

The area code of the player you purchased is shown on upper left of the bar code label on the package. For accessories supplied with your player, check the area code of your model and refer to "Supplied accessories" toward the end of this manual.



D-E440
D-E441SR
D-E445
D-E449CK

D-E441
D-E443
D-E446CK

Sony Corporation ©1999

Welcome!

Thank you for purchasing the Sony Compact Disc Compact Player. Before operating your player, please read this manual and retain it for future reference.

About this manual

The instructions in this manual are for the D-E440, D-E441, D-E441SR, D-E443, D-E445, D-E446CK and D-E449CK. Before you start reading, check your model number. The D-E440 is the model used for illustration purposes.

WARNING

To prevent fire or shock hazard, do not expose the unit to rain or moisture.

To avoid electrical shock, do not open the cabinet. Refer servicing to qualified personnel only.

CAUTION

The use of optical instruments with this product will increase eye hazard.

For the customers not in Poland

The mark on the unit is valid only for products marketed in Poland.

For the customers not in Europe

The CE mark on the unit is valid only for products marketed in the European Union.

For the customers not in Russia

This mark on the unit and package is valid only for products marketed in Russia.

Playing a CD right away!

If you want to play a CD right now, choose to use your player on house current. Other choices are the following three: rechargeable battery, dry batteries (see "Power Sources" on the reverse side) and car battery.

1 Connect

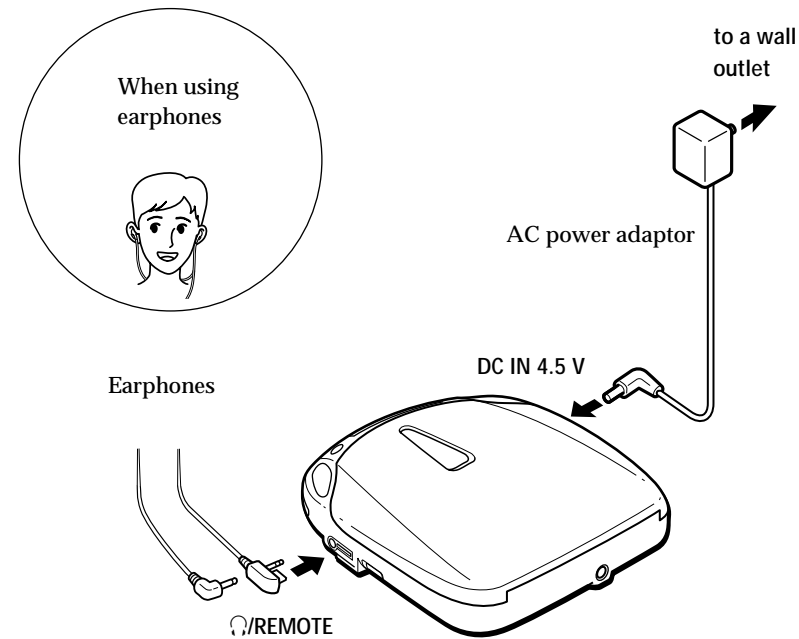

For models supplied with the AC plug adaptor
If the AC power adaptor does not fit the wall outlet, use the AC plug adaptor.

For models supplied with the remote control
• Connect the plug of the earphones to the remote control, not to the /REMOTE jack of the player.
• Connect the earphones to the remote control firmly. A loose connection may cause noise during playback.

2 Place a CD

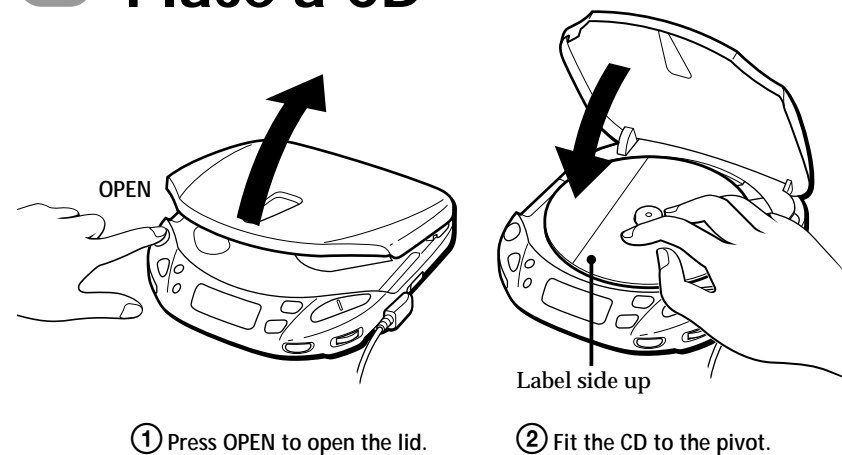

3 Play

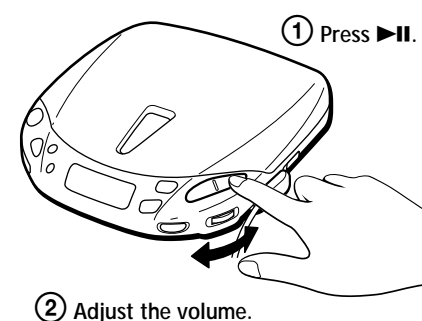

To stop play, press .

To	Press
Pause (main unit only)	
Resume play after pause (main unit only)	
Find the beginning of the current track (AMS*)	once**
Find the beginning of previous tracks (AMS)	repeatedly**
Find the beginning of the next track (AMS)	once**
Find the beginning of succeeding tracks (AMS)	repeatedly**
Go forward quickly	Hold down **
Go backwards quickly	Hold down **

*AMS = Automatic Music Sensor
**These operations are possible during both play and pause.

If you press REPEAT/ENTER to display , you can locate the tracks continuously in the following order:

- When using : next track → next track last track → first track → second track
- When using : previous track → previous track first track → last track

To remove the CD
Remove the CD while pressing the pivot.

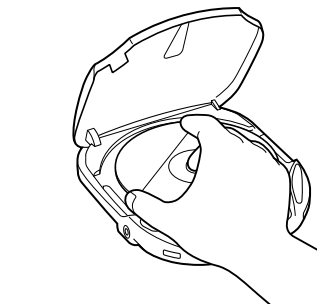

Notes on controlling the volume with the remote control

Set the VOL (volume) control on the remote control to the maximum. Then adjust the volume on the player to the level that you want to be the maximum volume of the remote control.

Notes on display

- When you press or (when RESUME is set to OFF), the total number of tracks in the CD and the total playing time appear for about 2 seconds.
- During play, the track number and the elapsed playing time of the current track appear.
- During pause, the elapsed playing time flashes in the display.
- Between tracks, the time to the beginning of the next track will appear with the "-" indication.

Notes on handling CDs

- To keep the CD clean, handle it by its edge. Do not touch the surface.
- Do not stick paper or tape onto the CD.
- Do not expose the CD to direct sunlight or heat sources such as hot air ducts. Do not leave the CD in a car parked under direct sunlight.

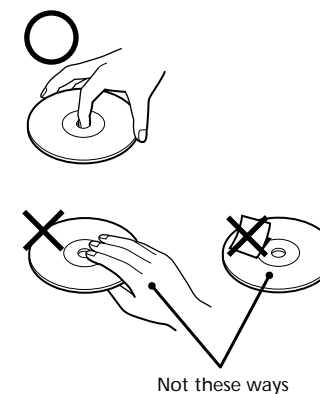

▶ Other Operations

Playing tracks repeatedly (Repeat Play)

You can play tracks repeatedly in normal, INTRO PGM, shuffle or RMS (Random Music Sensor) play modes. Repeat all the tracks or only one track.

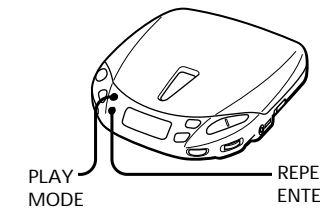

To repeat all the tracks
Press REPEAT/ENTER during play. The indication appears.



To cancel repeat play, press REPEAT/ENTER again.

To repeat a single track

1 Press REPEAT/ENTER while the track you want to repeat is playing. The indication appears.



2 Press PLAY MODE repeatedly until "1" appears.



To repeat another track, press or .

To cancel repeat play, press REPEAT/ENTER again.

Playing only the tracks you want (INTRO PGM Play)

You can choose and play your favorite tracks by scanning through the beginning of each track in a CD.

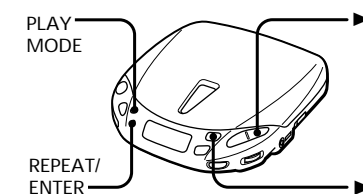

1 During play, press PLAY MODE repeatedly until "INTRO PGM" flashes.

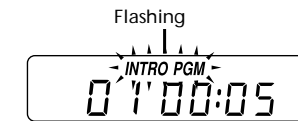

2 Press to start scanning. The player plays about the first 15 seconds of each track and "INTRO PGM" flashes faster.

3 Press REPEAT/ENTER while the track you want is playing. To skip the track, press or just wait for the next track.

After you have gone through the CD, "INTRO PGM" stops flashing and the tracks you have chosen play automatically.

To finish programming before going through the whole CD, press . The selected tracks will be played.

If you press , the program will be erased. To prevent accidental erasure, set the RESUME switch to ON.

To cancel INTRO PGM play, press PLAY MODE repeatedly until the play mode indication disappears from the display.

Playing tracks in random order (Shuffle Play)

You can play the tracks in a CD in random order.

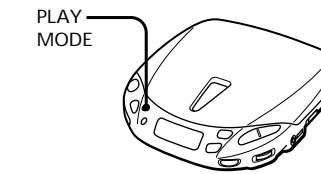

During play, press PLAY MODE repeatedly until "SHUF" appears. The tracks play in random order.

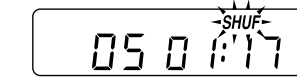

To cancel shuffle play, press PLAY MODE repeatedly until the play mode indication disappears from the display.

Note

- During shuffle play, you cannot return to previous tracks by pressing .

Playing tracks in the order you want (RMS play)

You can program up to 22 tracks to play in any order you choose.

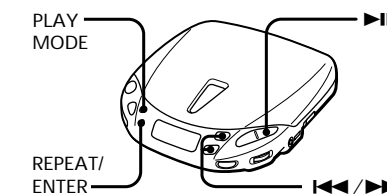

1 During play, press PLAY MODE repeatedly until "RMS" flashes.



*RMS = Random Music Sensor

2 Press or to choose a track. The track number and the playing order appear.

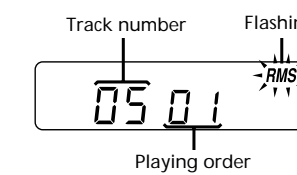

3 Press REPEAT/ENTER to program the track.

4 Repeat steps 2 and 3 to program the remaining tracks.

5 Press . "RMS" stops flashing and the tracks you have chosen play in the order you specified.

If you press , the program will be erased. To prevent accidental erasure, set the RESUME switch to ON.

To cancel RMS play, press PLAY MODE until "RMS" disappears.

To check the program

During programming:
Press REPEAT/ENTER before step 5.
During RMS play:
Press PLAY MODE repeatedly until "RMS" flashes, then press REPEAT/ENTER. Each time you press REPEAT/ENTER, the track number and the playing order appear in the order you specified.

Note

- If you program another track after the 22nd track, the first track programmed is cleared and the new track is programmed instead.

Using other functions

To minimize skipping (ESP)

The ESP (Electronic Shock Protection) function minimize skipping by using a buffer memory that stores music data and plays it back in the event of a shock. The new ESP² (ESP Squared) system uses a new DSP (Digital Signal Processor) which can read and store music data more efficiently, providing a level of continuous skip protection not found in traditional buffer memory units. This decreases the frequency of sound skipping and the need to utilize the buffer memory. Use this function when listening in a car or while walking.*
* Although ESP² provides excellent protection against skipping, it will not prevent skipping while jogging or running.

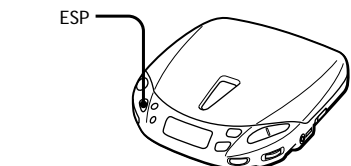

Press ESP. The ESP indication appears.

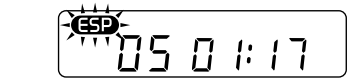

To release the ESP function, press ESP again.

Notes

- Playing may stop when the player gets a strong shock even with the ESP function on.
- You may hear a noise or sound skip when:
 - listening to a dirty or scratched CD.
 - listening to an audio test CD or.
 - the player receives continuous shock.
- Sound may drop for a while if you press ESP during play.

To enjoy more powerful bass sound (Sound function)

You can enjoy a powerful bass-boosted sound.

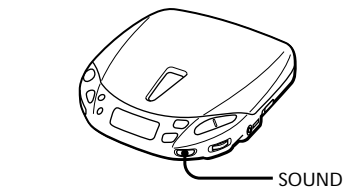

Press SOUND to select "MB (Mega Bass)" or "GRV (Groove)." "GRV" is more effective.

Note

- If the sound is distorted when emphasizing bass, turn down the volume.

To lock the buttons

You can lock your player against any accidental operations. You can still operate the player with the remote control.

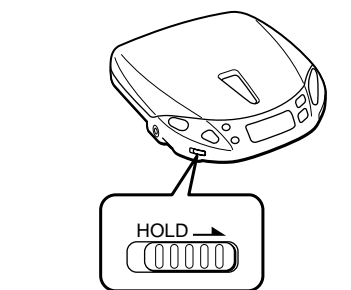

Slide HOLD in the direction of the arrow. When you press any button, "Hold" appears in the display and you cannot operate the player.

To unlock, slide HOLD back.

Continue to the reverse side →

To protect your hearing (AVLS)

The AVLS (Automatic Volume Limiter System) function keeps down the maximum volume to protect your ears.

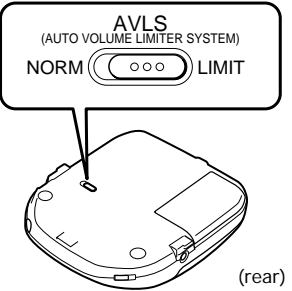

Set AVLS to LIMIT. The AVLS indication appears.



Note
 • If the sound is distorted when you listen to the bass-boosted sound with the AVLS function, turn down the volume.

To resume playing from the point you stopped the CD (Resume Play)

Normally, every time you stop and play, playing starts from the beginning of the CD. The resume play function, however, let you listen to from the point where you last turned off the player.

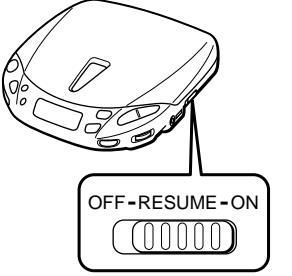

Set RESUME to ON.
 To cancel resume play, set RESUME to OFF.

Notes
 • Even if RESUME is set to ON, playing starts from the beginning when you open the lid.
 • The resume point may be inaccurate by about 30 seconds.

To turn off the beep

You can turn off the beep that sounds as you operate your player.
 Disconnect the power source (AC power adaptor, rechargeable battery or alkaline batteries). While you press and hold down ■, connect the power source again. To make the beep sound again, disconnect the power source, and then connect it without pressing ■.

Connecting to other stereo equipment

You can listen to the CD through other stereo equipment or record a CD on a cassette tape. Refer to the instruction manual of the other equipment for details. Before making connections, turn off each piece of equipment.

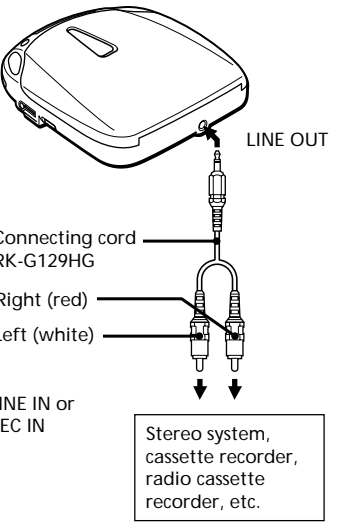

- Notes**
- When you use a connecting cord, the SOUND function will be disabled.
 - Before you play the CD, turn down the volume of the connected equipment so as not to damage the connected speakers.
 - The beep sound is not output from the LINE OUT jack.
 - When you connect other equipment to the LINE OUT jack of this player, adjust the volume on the connected equipment.
 - When you record a CD on a cassette tape using a tape recorder that has the blank search function, release the ESP function. If the ESP function is on, the blank search function does not work.

Playing a CD in a car

You can use your player in a car as illustrated below.

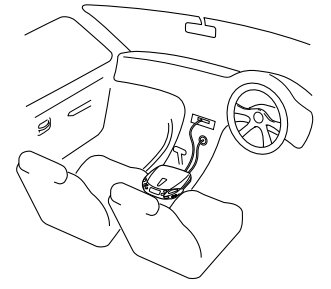

- To connect your player to a car cassette deck, you need the following accessories:
- Car connecting pack
 - Car battery cord
 - or,
 - Mount kit CPM-300PC (Mount plate + Car connecting pack + Car battery cord)
 - Car battery cord with car connecting pack DCC-E26CP
- Refer to the instruction manual of each accessory for details.

When you use the CPM-300PC mount kit/CPM-300P mount plate

Attach the car mount adaptor supplied to the CPM-300PC/300P before installing the player.

- Notes**
- Do not put the player on the dashboard.
 - Do not leave the player in a car parked under sunlight.
 - Use a Sony car connecting pack for reducing noise.
 - Use only the car battery cord listed in the optional accessories. If you use any other car battery cord, smoke, fire or malfunction may occur.

Switched ignition function (when using the car battery cord)

With this feature, your player stops automatically when you turn off the engine of the car. (This function is not possible with some cars depending on the model.)

Using the remote control

For the customers supplied with the remote control:
 You can use the remote control as the wired remote control.

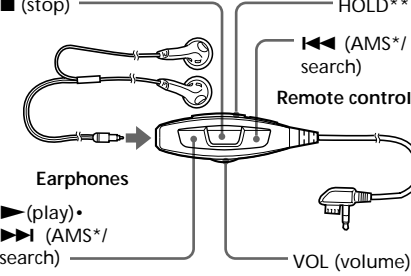

* Automatic Music Sensor
 ** When you are not using the remote control, slide HOLD in the direction of the arrow to prevent any accidental operations. To unlock, slide HOLD back.

Note
 • Use only the supplied remote control. You cannot operate this player with the remote control supplied with other models.

Power Sources

Using rechargeable battery

Charge the rechargeable battery before using it for the first time. Use only BP-DM10 or BP-DM20 rechargeable battery for this player. Do not use any other rechargeable batteries. You can use BP-DM10 and BP-DM20 in the same way, but their charging time and battery life are different. Check the model number of your rechargeable battery before using it.

- 1 Open the lid of the battery compartment.

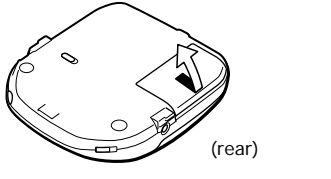

- 2 Insert the rechargeable battery so that the word "SONY" is facing the same direction as illustrated inside the lid, and close the lid.

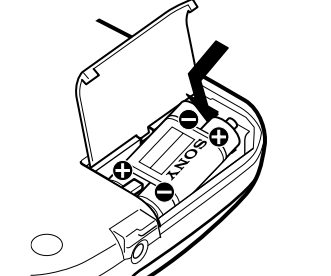

- 3 Connect the AC power adaptor. The indication "CHG" lights up. Charge for about 2 hours (for BP-DM10) or 3.5 hours (for BP-DM20). (If the battery has been fully charged, "CHG" and ■ flash.)

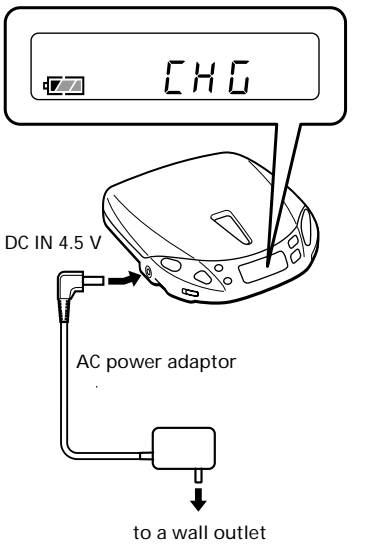

- 4 When fully charged, "CHG" disappears. Disconnect the AC power adaptor.

When to charge the battery

When the battery becomes weak, ■ indication appears in the display. If the "Lo bātt" appears in the display, charge the rechargeable battery, because the battery is used up. To keep the original battery capacity for a long time, recharge the battery when the battery is used up (discharged).

- Notes**
- Charging time varies depending on how the rechargeable battery is used.
 - If the battery is new or has not been used for a long time, it may not be charged completely until you charge and discharge it several times.
 - If the battery life becomes shorter by about half, replace it with Sony BP-DM10 or BP-DM20 rechargeable battery. Do not use any other rechargeable battery (R6 type rechargeable battery, etc.).

Using dry batteries

- 1 Open the lid of the battery compartment.

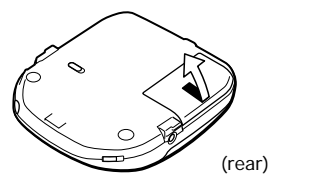

- 2 Insert two LR6 (size AA) alkaline batteries by matching the ⊕ and ⊖ to the diagram inside the battery compartment and close the lid.

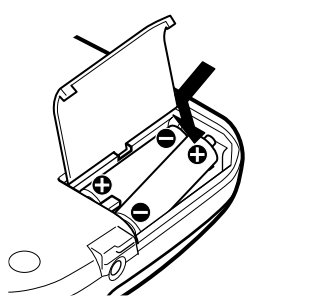

Note
 • Do not use manganese batteries for this player.

To take out the dry batteries

Pull the ⊕ side of the battery as shown.

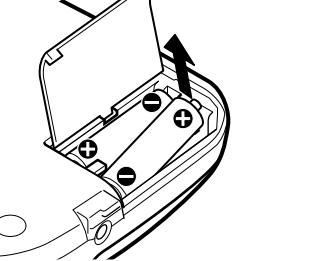

When to replace the dry batteries

When the battery becomes weak, ■ indication appears in the display. If the "Lo bātt" appears in the display, replace all the batteries with new ones, because the batteries are used up.

- Notes**
- Do not charge the dry batteries.
 - Do not mix new batteries with old ones.
 - Do not use different types of batteries together.
 - When the batteries are not to be used for a long time, remove them.
 - If the battery leakage occurs, wipe off any deposit in the battery compartment, and install new batteries.

Battery life (approx. hours)(EIAJ*)

When using	ESP function	
	off	on
BP-DM20 (charged for about 3.5 hours**)	9	9
Two Sony alkaline batteries LR6SG	16	15
BP-DM10 (charged for about 2 hours**)	5	4.5

*Measured value by the standard of EIAJ (Electronic Industries Association of Japan) (When the unit is used on a flat and stable place)
 **Charging time varies depending on how the rechargeable battery is used.

How to attach the battery compartment lid

If the battery compartment lid is detached by an accidental drop, excessive force, etc., attach it as illustrated in the numbered order.

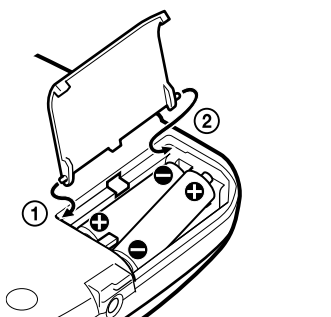

Additional Information

Precautions

- On safety**
- Should any solid objects or liquid fall into the unit, unplug it and have it checked by qualified personnel before operating it any further.
 - Do not put any foreign objects in the DC IN 4.5 V (external power input) jack.

On power sources

- When you are not using the player for a long time, disconnect all power sources from the player.
- The nameplate indicating operating voltage, power consumption, etc. is located at the bottom of the AC power adaptor (for EA3 only.)

On the AC power adaptor

- Use only the supplied AC power adaptor. If your player is not supplied with it, use AC-E45HG AC power adaptor. Do not use any other AC power adaptor.

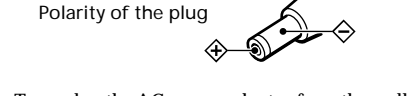

- To unplug the AC power adaptor from the wall outlet, grasp the adaptor itself, do not pull its cord.

On dry and rechargeable batteries

- Do not throw the batteries into fire.
- Do not carry the rechargeable battery with coins or other metallic objects. It can generate heat if the positive and negative terminals of the battery are accidentally contacted by a metallic object.

For the customers having purchased the world model

Certain countries may regulate disposal of the battery used to power this product. Please consult with your local authority.

On the player

- Keep the lens of the player clean and do not touch it. If you do so, the lens may be damaged and the player will not operate properly.
- Do not put any heavy object on top of the player. The unit and the CD may be damaged.
- Do not leave the player in a location near heat sources, or in a place subject to direct sunlight, excessive dust or sand, moisture, rain, mechanical shock, unlevelled surface, or in a car with its windows closed.
- If the player causes interference to radio or television reception, turn off the player or move it away from the radio or television.
- Do not wrap the player in a cloth or blanket during use as it may cause malfunction or serious accidents.

On headphones/earphones

Road safety
 Do not use headphones/earphones while driving, cycling, or operating any motorized vehicle. It may create a traffic hazard and is illegal in some areas. It can also be potentially dangerous to play your headsets at high volume while walking, especially at pedestrian crossings. You should exercise extreme caution or discontinue use in potentially hazardous situations.

Preventing hearing damage

Avoid using headphones/earphones at high volume. Hearing experts advise against continuous, loud and extended play. If you experience a ringing in your ears, reduce volume or discontinue use.

Caring for others
 Keep the volume at a moderate level. This will allow you to hear outside sounds and to be considerate to the people around you.

Maintenance

To clean the lens

Clean the lens with a lens cleaning kit KK-DM1.

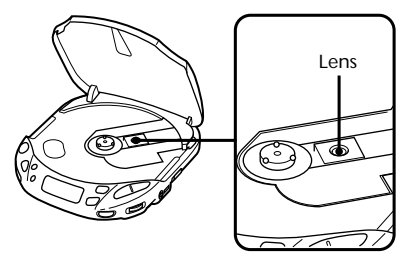

To clean the casing

Use a soft cloth slightly moistened in water or a mild detergent solution. Do not use alcohol, benzine or thinner.

Troubleshooting

Should any problem persist after you have made these checks, consult your nearest Sony dealer.

The CD does not play or "no disc" appears in the display though a CD is placed in the unit.

- The CD is dirty or defective.
- Insert the CD with the label side up.
- Moisture condensation has occurred. Leave the unit aside for several hours until the moisture evaporates.
- The lens is dirty.
- Close the lid of the unit and the battery compartment firmly.
- Make sure the batteries are inserted correctly.
- Connect the AC power adaptor to a wall outlet securely.

When you press ►II, "00" appears in the display for a moment, and disappears. The CD does not play.

- Rechargeable battery or dry batteries are used up. Charge the rechargeable battery or replace dry batteries with new ones.

No sound, or noise is heard.

- Connect the plugs firmly.
- Plugs are dirty. Clean the plugs with a dry soft cloth periodically.

"Hi disc" appears in the display.

- Use only the supplied AC power adaptor or AC power adaptor AC-E45HG (not supplied).

"Hold" appears in the display when you press a button.

- The buttons are locked. Slide HOLD back.

"Lo bātt" appears in the display when you press a button.

- The rechargeable battery is used up completely. Connect the AC power adaptor and charge the battery.
- The dry batteries are used up. Replace them with new ones.

The battery life is short.

- Manganese batteries are used. Use alkaline batteries.
- Replace the batteries with new ones.

The volume is limited to a certain level even if you attempt to turn it up.

- AVLS selector is set to LIMIT. Set it to NORM.
- The earphones are connected to the LINE OUT jack. Connect them to the REMOTE jack.

Specifications

CD player

- System Compact disc digital audio system
 Laser diode properties
 Material: GaAlAs
 Wavelength: λ = 780 nm
 Emission duration: Continuous
 Laser output: Less than 44.6 μW (This output is the value measured at a distance of 200 mm from the objective lens surface on the optical pick-up block with 7 mm aperture.)
- Error correction Sony Super Strategy Cross Interleave Reed Solomon Code
- D-A conversion 1-bit quartz time-axis control
- Frequency response 20 - 20,000 Hz ±1dB (measured by EIAJ CP-307)
- Output (at 4.5 V input level)
 Headphones (stereo minijack) 15 mW + 15 mW at 16 ohms
 Line output (stereo minijack) Output level 0.7 V rms at 47 kilohms Recommended load impedance over 10 kilohms

General

Power requirements
 For the area code of the model you purchased, check the upper left side of the bar code on the package.

- Sony BP-DM10 Rechargeable battery: 2.4 V DC, Ni-Cd, 650 mAh
- Sony BP-DM20 Rechargeable battery: 2.4 V DC, Ni-MH, 1,200 mAh
- Two LR6 (size AA) batteries: 3 V DC
- AC power adaptor (DC IN 4.5 V jack): U2/CA2/E92/MX2 model: 120 V, 60 Hz CED/CEX/EE1/E13/CE7/CEW/EE/G5/G6/G7/G8 model: 220 - 230 V, 50/60 Hz CEK model: 230 - 240 V, 50 Hz EA3 model: 110 - 240 V, 50/60 Hz AU2 model: 240 V, 50 Hz JE.W/E33 model: 100 - 240 V, 50/60 Hz HK2 model: 220 V, 50/60 Hz CN2/AR1 model: 220 V, 50 Hz
- Sony CPM-300P mount plate for use on car battery: 4.5 V DC

Dimensions (w/h/d) (without projecting parts and controls)

Approx. 129 × 28 × 146 mm (5 1/4 × 1 1/8 × 5 3/4 in.)

Mass (without rechargeable battery)

Approx. 220 g (7.8 oz)
Operating temperature 5°C - 35°C (41°F - 95°F)

Supplied accessories

For the area code of the model you purchased, check the upper left side of the bar code on the package.
 D-E440 Earphones (1)
 D-E441 AC power adaptor (1)
 Earphones (1)
 AC plug adaptor (1)*
 *Supplied with E13 model

D-E441SR AC power adaptor (1)
 Earphones (1)
 Active speaker system (1)

D-E443 AC power adaptor (1)
 Earphones (1)
 Rechargeable battery (1)
 AC plug adaptor (1)*
 *Supplied with E13 model

D-E445 AC power adaptor (1)
 Earphones with remote control(1)
 Rechargeable battery (1)
 AC plug adaptor (1)*
 *Supplied with E13 model

D-E446CK AC power adaptor (1)
 Earphones (1)
 Car battery cord (1)
 Car connecting pack (1)
 Velcro tape (2)
 Spare fuse (1)
 Spiral tube (1)
 AC plug adaptor (1)*
 *Supplied with E13 model
 D-E449CK AC power adaptor (1)
 Rechargeable battery (1)
 Headphones with remote control (1)
 Car battery cord (1)
 Car connecting pack (1)
 Velcro tape (2)
 Spare fuse (1)
 Spiral tube (1)

Design and specifications are subject to change without notice.

Optional accessories

Mount plate CPM-300P
 Mount kit CPM-450PC*
 Mount kit CPM-300CP
 Car connecting pack CPA-9
 Car battery cord with car connecting pack DCC-E26CP
 Car battery cord DCC-E245
 Active speaker system SRS-A15, SRS-A35, SRS-A71, SRS-T1
 Rechargeable battery BP-DM10, BP-DM20
 Connecting cord RK-G129HG, RK-G136HG
 AC power adaptor AC-E45HG
 Stereo headphones MDR-A44L, MDR-301LP, MDR-E848LP, MDR-35**
 * Sold in Japan only
 ** When connecting optional headphones to the supplied remote control, use only headphones with stereo mini plugs. You cannot use headphones with micro plugs.

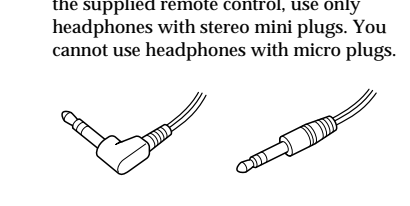

Your dealer may not handle some of the above listed accessories. Please ask the dealer for detailed information about the accessories in your country.