

# ***Video Cassette Recorder***

---

Operating Instructions



***SLV-SE10EG  
SLV-SX10EG***

## WARNING

To prevent fire or shock hazard, do not expose the unit to rain or moisture.

To avoid electrical shock, do not open the cabinet. Refer servicing to qualified personnel only.

Mains lead must only be changed at a qualified service shop.

## Precautions

### Safety

- This unit operates on 220 – 240 V AC, 50 Hz. Check that the unit's operating voltage is identical with your local power supply.
- If anything falls into the cabinet, unplug the unit and have it checked by qualified personnel before operating it any further.
- The unit is not disconnected from the mains as long as it is connected to the mains, even if the unit itself has been turned off.
- Unplug the unit from the wall outlet if you do not intend to use it for an extended period of time. To disconnect the cord, pull it out by the plug, never by the cord.

### Installing

- Allow adequate air circulation to prevent internal heat buildup.
- Do not place the unit on surfaces (rugs, blankets, etc.) or near materials (curtains, draperies) that may block the ventilation slots.
- Do not install the unit near heat sources such as radiators or air ducts, or in a place subject to direct sunlight, excessive dust, mechanical vibration or shock.
- Do not install the unit in an inclined position. It is designed to be operated in a horizontal position only.
- Keep the unit and cassettes away from equipment with strong magnets, such as microwave ovens or large loudspeakers.
- Do not place heavy objects on the unit.
- If the unit is brought directly from a cold to a warm location, moisture may condense inside the VCR and cause damage to the video head and tape. When you first install the unit, or when you move it from a cold to a warm location, wait for about three hours before operating the unit.

## Caution

Television programmes, films, video tapes and other materials may be copyrighted. Unauthorized recording of such material may be contrary to the provisions of the copyright laws. Also, use of this recorder with cable television transmission may require authorization from the cable television transmitter and/or programme owner.

## Compatible colour systems

This VCR is designed to record using the PAL (B/G or D/K) or MESECAM (B/G or D/K) colour system and play back using the PAL (B/G or D/K), MESECAM (B/G or D/K), and NTSC 4.43 colour systems.

---

# Table of contents

---

## Getting Started

- 4 Step 1: Unpacking
- 5 Step 2: Setting up the remote commander
- 7 Step 3: Connecting the VCR
- 10 Step 4: Tuning your TV to the VCR
- 12 Step 5: Setting up the VCR with the Auto Set Up function
- 14 Step 6: Setting the clock
- 16 Selecting a language
- 17 Presetting channels
- 21 Changing/disabling programme positions

## Basic Operations

- 25 Playing a tape
- 28 Recording TV programmes
- 31 Recording TV programmes using the timer

## Additional Operations

- 34 Playing/searching at various speeds
- 36 Setting the recording duration time
- 37 Checking/changing/cancelling timer settings
- 39 Searching using the Smart Search function
- 42 Adjusting the picture
- 44 Changing menu options
- 46 Editing with another VCR

## Additional Information

- 48 Troubleshooting
- 51 Specifications
- 52 Index to parts and controls
- Back cover
- Index

# Step 1

## Unpacking

Check that you have received the following items with the VCR:

- Remote commander

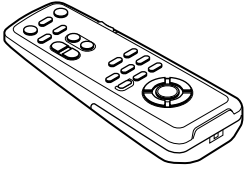

- Aerial cable

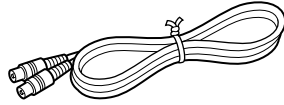

- R6 (size AA) batteries

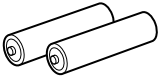

## Step 2

# Setting up the remote commander

### Inserting the batteries

Insert two R6 (size AA) batteries by matching the + and - on the batteries to the diagram inside the battery compartment.

Insert the negative (-) end first, then push in and down until the positive (+) end clicks into position.

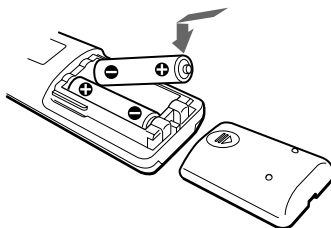

### Using the remote commander

You can use this remote commander to operate this VCR and a Sony TV. Buttons on the remote commander marked with a dot (•) can be used to operate your Sony TV. If the TV does not have the  symbol near the remote sensor, this remote commander will not operate the TV.

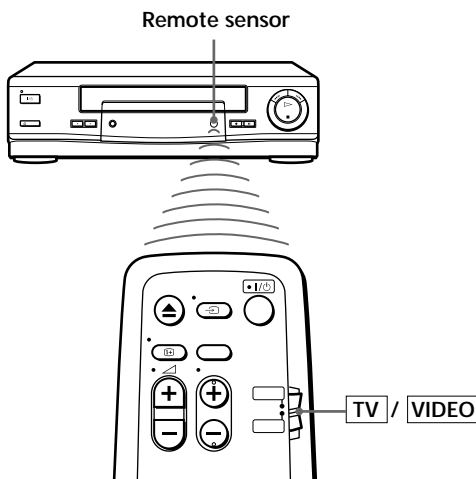

To operate	Set <b>TV</b> / <b>VIDEO</b> to
the VCR	<b>VIDEO</b> and point at the remote sensor on the VCR
a Sony TV	<b>TV</b> and point at the remote sensor on the TV

continued

## Step 2 : Setting up the remote commander (continued)

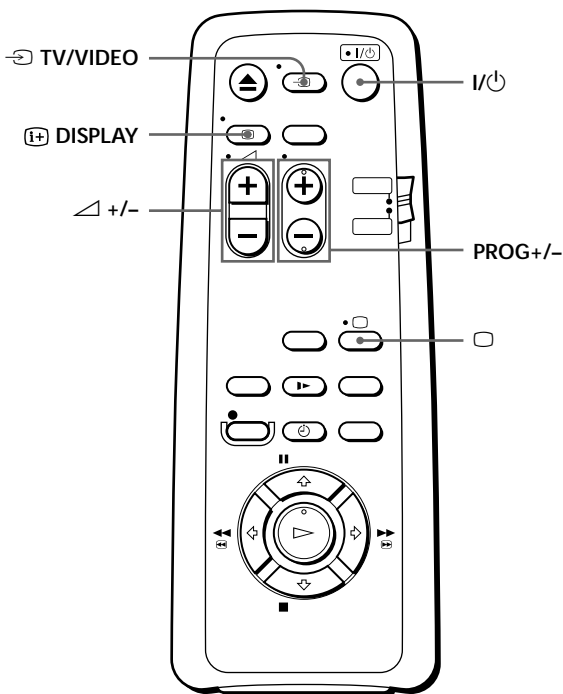

### TV control buttons

To	Press
Turn the TV into standby mode	I/O
Select an input source of the TV either from aerial in or from line in	TV/VIDEO
Select the programme position of the TV	PROG +/-
Adjust the volume of the TV	+/-
Turn on the TV	□ (TV)
Call up on-screen display	DISPLAY

### Notes

- With normal use, the batteries should last about three to six months.
- If you do not use the remote commander for an extended period of time, remove the batteries to avoid possible damage from battery leakage.
- Do not use a new battery with an old one together.
- Do not use different types of batteries together.
- Some buttons may not work with certain Sony TVs.

## Step 3

# Connecting the VCR

If your TV has a EURO-AV connector, see page 8.

## If your TV does not have a EURO-AV (Scart) connector

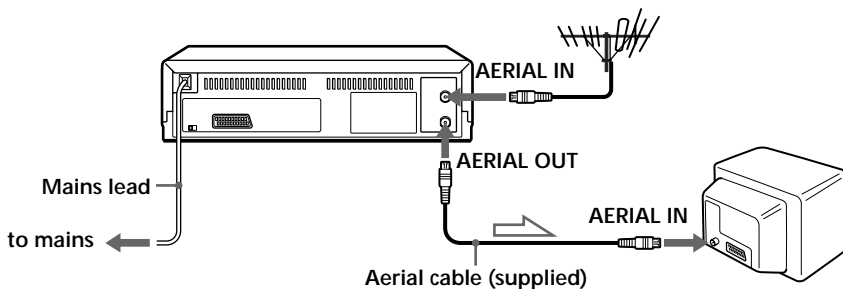

: Signal flow

### 1

Disconnect the aerial cable from your TV and connect it to AERIAL IN on the rear panel of the VCR.

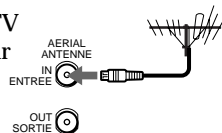

### 2

Connect AERIAL OUT of the VCR and the aerial input of your TV using the supplied aerial cable.

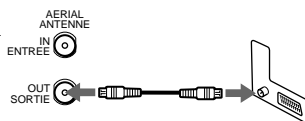

### 3

Connect the mains lead to the mains.

#### Note

- When you connect the VCR and your TV only with an aerial cable, you have to set RF MODULATOR in the OPTIONS-2 menu to ON (initial setting) (see page 45).

continued

### Step 3 : Connecting the VCR (continued)

#### If your TV has a EURO-AV (Scart) connector

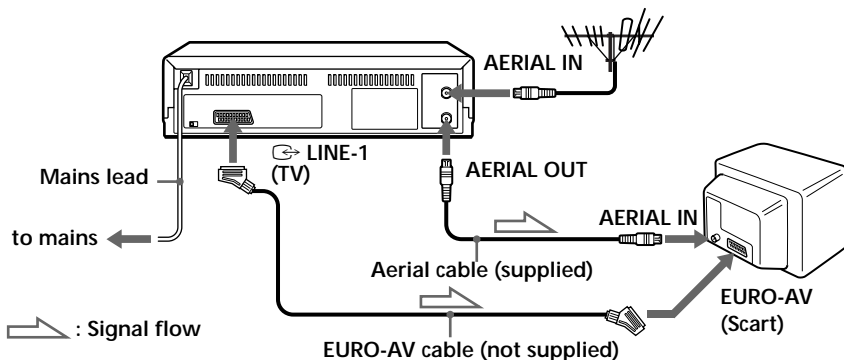

1

Disconnect the aerial cable from your TV and connect it to AERIAL IN on the rear panel of the VCR.

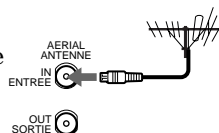

2

Connect AERIAL OUT of the VCR and the aerial input of your TV using the supplied aerial cable.

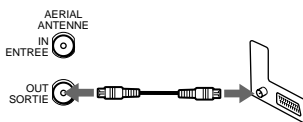



---

**3**

Connect LINE-1 (TV) on the VCR and the EURO-AV (Scart) connector on the TV with the optional EURO-AV cable.

This connection improves picture and sound quality. Whenever you want to watch the VCR picture, press  TV/VIDEO to display the VIDEO indicator in the display window.

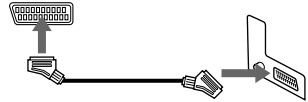

---

**4**

Connect the mains lead to the mains.

---

**Note**

- If the TV is connected to the LINE-1 (TV) connector, setting the RF MODULATOR in the OPTIONS-2 menu to OFF is recommended. In the OFF position, only the signal from the aerial is output through the AERIAL OUT connector (see page 45). You do not have to tune your TV to the VCR. Skip “Tuning your TV to the VCR” on page 10.

## Step 4

# Tuning your TV to the VCR

If you have connected the VCR to your TV using the EURO-AV cable, skip this step.

I/⏻ ON/STANDBY

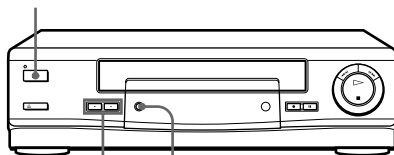

PROGRAM +/- RF CHANNEL

1

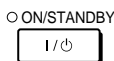

Press I/⏻ ON/STANDBY to turn on the VCR.

2



Press RF CHANNEL on the VCR lightly.

The factory-preset RF channel appears in the display window.

The VCR signal is output through this channel to the TV.

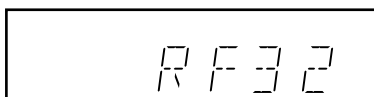

3

Turn on your TV and select a programme position for the VCR picture.

This programme position will now be referred to as the video channel.

4



Press RF CHANNEL.

The TV system appears in the display window.

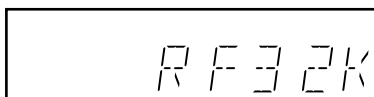

- 5**  Press PROGRAM +/- (repeatedly) to select the appropriate TV system for your area. Select “G” for the B/G TV system, or “K” for the D/K TV system.

- 6** Tune the TV to the same channel as that shown in the display window so that the picture on the right appears clearly on the TV screen.

Refer to your TV manual for tuning instructions.

If you select the wrong TV system in step 5, the picture on the right may not appear. Select the appropriate TV system and tune the TV again.

If the picture does not appear clearly, see “To obtain a clear picture from the VCR” below.



- 7**  Press RF CHANNEL.

You have now tuned your TV to the VCR. Whenever you want to play a tape, set the TV to the video channel.

#### To check to see if the TV tuning is correct

Set the TV to the video channel and press PROGRAM +/- on the VCR. If the TV screen changes to a different programme each time you press PROGRAM +/-, the TV tuning is correct.

#### To obtain a clear picture from the VCR

If the screen does not appear clearly in step 6 above, go to step 7 to finish this procedure once. Then start again from step 2. After pressing RF CHANNEL in step 2, press PROGRAM +/- while the RF channel is displayed, so that another RF channel appears. Then tune the TV to the new RF channel until a clear picture appears.

#### Note

- If you set the wrong TV system, you may have no sound or sound may be distorted.

## Step 5

# Setting up the VCR with the Auto Set Up function

Before using the VCR for the first time, set up the VCR using the Auto Set Up function. With this function, you can set the language for the on-screen display and TV channels.

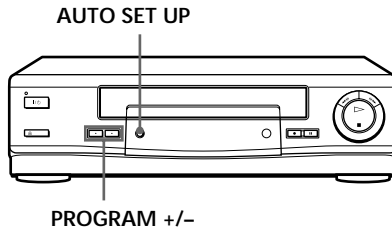

1



Hold down AUTO SET UP on the VCR for more than three seconds. The VCR automatically turns on, and the country abbreviation appears in the display window.

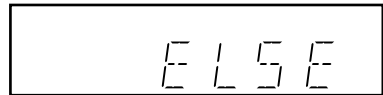

2



Press PROGRAM +/- to select the abbreviation of your country. For some countries, there is a selection of languages to choose from. The abbreviations of the countries and languages are as follows:

Abbreviation	Country	Language
CZ	Checho	Czech
H	Hungary	Hungarian
PL	Poland	Polish
RU	Russia	Russian
ELSE	Other countries	English

If your country does not appear, select ELSE.

**3**AUTO  
SET UP

Press AUTO SET UP lightly.

The VCR starts searching for all of the receivable channels and presets them according to the TV system you selected in “Tuning your TV to the VCR.”



After the search or download is complete, the current time appears in the display window for any stations that transmit a time signal.

### To cancel the Auto Set Up function

Press AUTO SET UP.

#### Tip

- If you want to change the language for the on-screen display from the one preset in the Auto Set Up function, see page 16.

#### Note

- Do not cancel the Auto Set Up function during step 3. If you do, repeat the steps above.

## Step 6

# Setting the clock

You must set the time and date on the VCR to use the timer recording features properly.

Before you start...

- Turn on the VCR and the TV.
- Set the TV to the video channel.

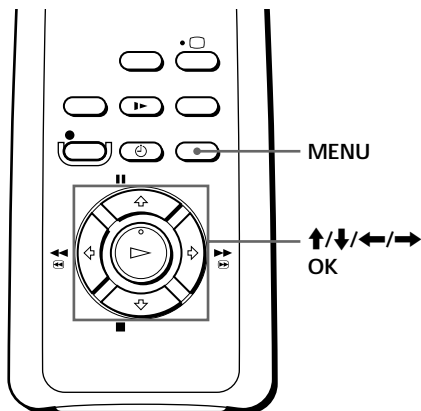

1



Press MENU, then press ↑/↓ to highlight SETTINGS and press OK.

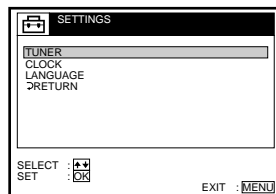

2



Press ↑/↓ to highlight CLOCK, then press OK.

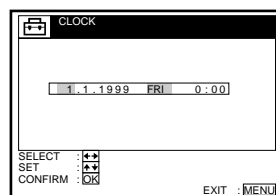

3



Press ↑/↓ to set the date.

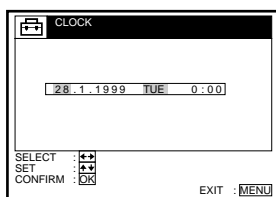

4



Press **→** to highlight the month and set the month pressing **↑/↓**.

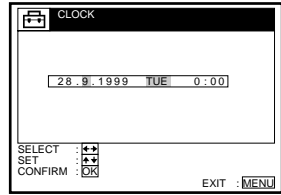

5



Set the year, hour, and minutes in sequence, pressing **→** to highlight the item to be set, and press **↑/↓** to select the digits.

The day of the week is set automatically.

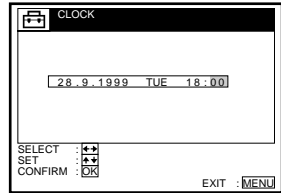

6



Press OK to start the clock.

#### Tips

- To change the digits during setting, press **←** to return to the item to be changed, and select the digits pressing **↑/↓**.
- If you want to return to the previous menu, highlight RETURN and press OK.

#### Note

- The menu disappears automatically if you don't proceed for more than a few minutes.

# Selecting a language

You can change the on-screen display language from the one you selected with the Auto Set Up function.

Before you start...

- Turn on the VCR and the TV.
- Set the TV to the video channel.

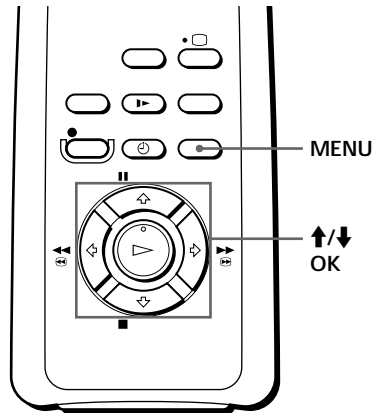

- 1 Press MENU, then press  $\uparrow/\downarrow$  to highlight SETTINGS and press OK.

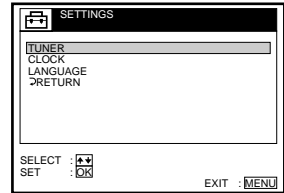

- 2 Press  $\uparrow/\downarrow$  to highlight LANGUAGE, then press OK.



- 3 Press  $\uparrow/\downarrow$  to highlight the desired language, then press OK.



- 4 Press MENU to exit the menu.



## Tip

- If you want to return to the previous menu, highlight RETURN and press OK.

## Note

- The menu disappears automatically if you don't proceed for more than a few minutes.



# Presetting channels

If some channels could not be preset using the Auto Set Up function, you can preset them manually.

Before you start...

- Turn on the VCR and the TV.
- Set the TV to the video channel.

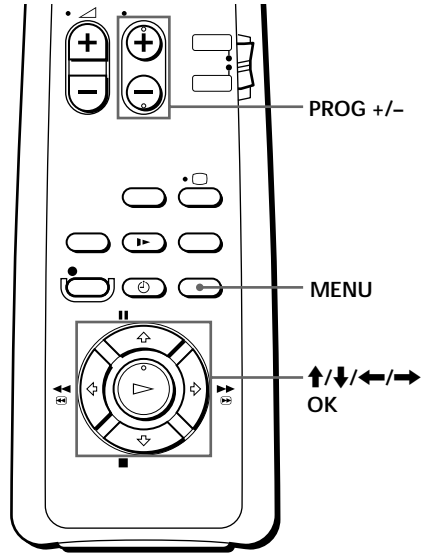

1



Press MENU, then press  $\uparrow/\downarrow$  to highlight SETTINGS and press OK.

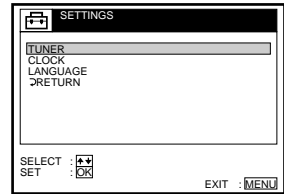

2



Press  $\uparrow/\downarrow$  to highlight TUNER, then press OK.

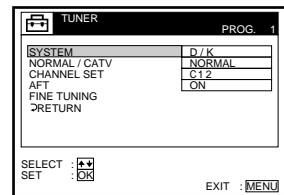

continued

## Presetting channels (continued)

3



Press **↑/↓** to highlight NORMAL/  
CATV, then press OK.

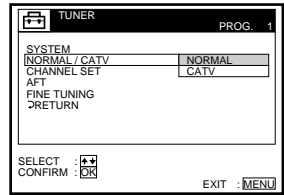

4



Press **↑/↓** to highlight NORMAL, then  
press OK.

To preset CATV (Cable Television)  
channels, select CATV.

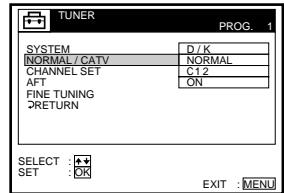

5



Press PROG +/- to select the programme  
position.

Selected programme  
position

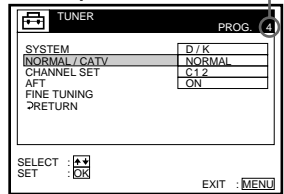

6



Press **↑/↓** to highlight CHANNEL SET,  
then press OK.

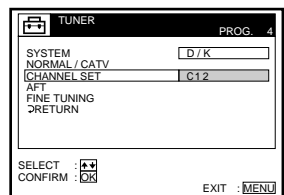

7



Press **↑/↓** repeatedly until the channel you want is displayed.

The channels appear in the following order:

B/G TV system		D/K TV system	
Channel number in the CHANNEL SET field	Receivable Channel	Channel number in the CHANNEL SET field	Receivable Channel
C02	E2	C02	R1
C03	E3	C05	R6
C04	E4	C06	R7
C05	E5	C12	R12
C06	E6	C13	R2
C07	E7	C14	R3
C08	E8	C15	R4
C09	E9	C16	R5
C10	E10	C17	R8
C11	E11	C18	R9
C12	E12	C19	R10
C21-C69	E21-E69	C20	R11
S01-S41	S1-S41	C21-C69	R21-R69
S42-S46	S01-S05		

8



If the TV sound is distorted or noisy, press **↑/↓** to highlight **SYSTEM** and press **OK**. Then press **↑/↓** to select **B/G** or **D/K** so that you get the better sound.

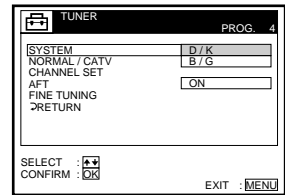

9

To allocate another channel to another programme position, repeat steps 5 to 8.

10



Press **MENU** to exit the menu.

continued

## Presetting channels (continued)

### Disabling unwanted programme positions

After presetting channels, you can disable unused programme positions. The disabled positions will be skipped later when you press the PROG +/- buttons.

- 1 In step 7 above, press  $\uparrow/\downarrow$  repeatedly to display the number "00" beside CHANNEL SET.
- 2 Press MENU to exit the menu.

### If the picture is not clear

Normally, the Auto Fine Tuning (AFT) function automatically tunes in channels clearly. If, however, the picture is not clear, you may also use the manual tuning function.

- 1 Press PROG +/- to select the programme position for which you cannot obtain a clear picture.
- 2 Press MENU, then select SETTINGS and press OK.
- 3 Select TUNER, then press OK.
- 4 Select FINE TUNING, then press OK.

The fine tuning meter appears.

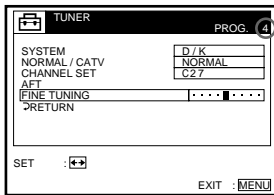

Selected programme position

- 5 Press  $\leftarrow/\rightarrow$  to get a clearer picture, then press MENU to exit the menu.

Note that the AFT (Auto Fine Tuning) setting switches to OFF.

#### Tip

- If you want to return to the previous menu, highlight RETURN and press OK.

#### Note

- The menu disappears automatically if you don't proceed for more than a few minutes.

# Changing/ disabling programme positions

After setting the channels, you can change the programme positions as you like. If any programme positions are unused or contain unwanted channels, you can disable them.

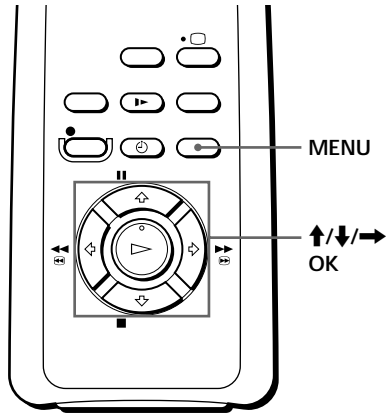

## Changing programme positions

Before you start...

- Turn on the VCR and the TV.
- Set the TV to the video channel.

1

MENU



Press MENU, then press  $\uparrow/\downarrow$  to highlight LISTS and press OK.

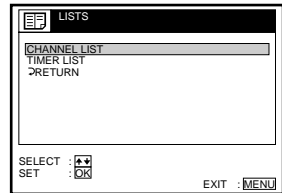

2

Press  $\uparrow/\downarrow$  to highlight CHANNEL LIST, then press OK.

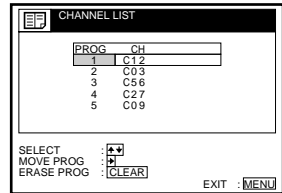

continued

## Changing/disabling programme positions (continued)

3



Press  $\uparrow/\downarrow$  to highlight the row on which you want to change the programme position, then press  $\rightarrow$ .

To display other pages for programme positions 6 to 60, press  $\uparrow/\downarrow$  repeatedly.

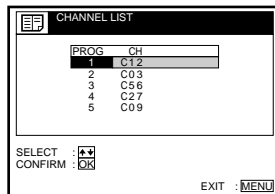

4



Press  $\uparrow/\downarrow$  until the selected channel row moves to the desired programme position.

The selected channel is inserted at the new programme position and the intermediate channels are displaced to fill the gap.

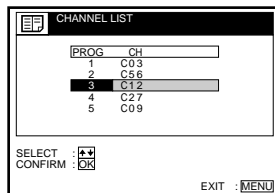

5



Press OK to confirm the setting.

6

To change the programme position of another station, repeat steps 3 to 5.

7



Press MENU to exit the menu.

### Tip

- If you want to return to the previous menu, highlight RETURN and press OK.

### Note

- The menu disappears automatically if you don't proceed for more than a few minutes.

## Disabling unwanted programme positions

After presetting channels, you can disable unused programme positions. The disabled positions will be skipped later when you press the PROG +/- buttons.

Before you start...

- Turn on the VCR and the TV.
- Set the TV to the video channel.

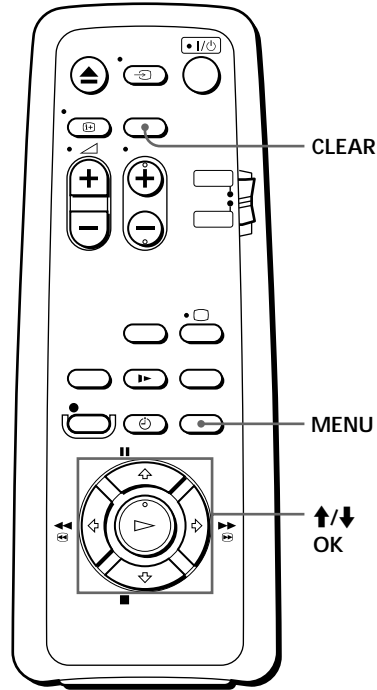

1

MENU



Press MENU, then press **↑/↓** to highlight **LISTS**, and press OK.

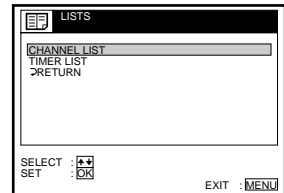

continued

## Changing/disabling programme positions (continued)

2



Press  $\uparrow/\downarrow$  to highlight CHANNEL LIST, then press OK.

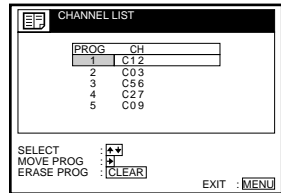

3



Press  $\uparrow/\downarrow$  to highlight the row on which you want to disable.

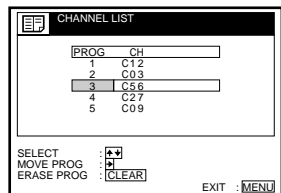

4



Press CLEAR.

The selected row will be cleared as shown on the right.

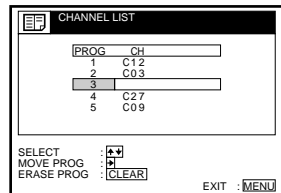

5

Repeat steps 3 and 4 for any other programme positions you want to disable.

6



Press MENU to exit the menu.

### Tip

- If you want to return to the previous menu, highlight RETURN and press OK.

### Note

- The menu disappears automatically if you don't proceed for more than a few minutes.
- Be sure to select the programme position you want to disable correctly. If you disable a programme position by mistake, you need to reset that channel manually.



# Playing a tape

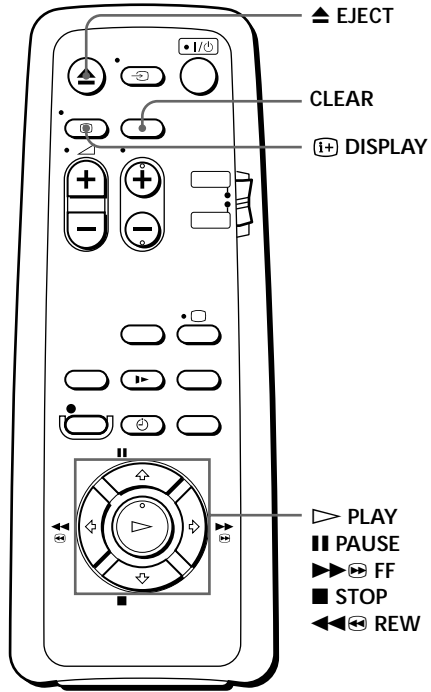
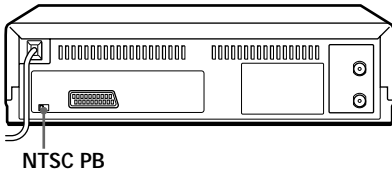

**1** Turn on your TV and set it to the video channel.

**2** Insert a tape.  
The VCR turns on and starts playing automatically if you insert a tape with its safety tab removed.

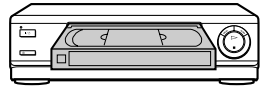

**3** Press ▶ PLAY.  
When the tape reaches the end, it will rewind automatically.



continued

## Playing a tape (continued)

### Additional tasks

To	Press
Stop play	■ STOP
Pause play	PAUSE
Resume play after pause	PAUSE or ▷ PLAY
Fast-forward the tape	▶▶ Ⓜ FF during stop
Rewind the tape	◀◀ Ⓜ REW during stop
Eject the tape	▲ EJECT

### To set the colour system

If the playback picture has no colour, or streaks appear during playback, set COLOUR SYSTEM in the OPTIONS-1 menu to conform to the system that the tape was recorded in (see page 45). (Normally set the option to AUTO.)

### To play an NTSC-recorded tape

Set NTSC PB at the rear of the VCR according to the colour system of your TV.

When your TV is	Set NTSC PB to
PAL only	ON PAL TV
PAL and NTSC	NTSC 4.43

### To use the time counter

At the point on the tape that you want to find later, press CLEAR. The counter in the display window resets to "0:00:00." Search for the point afterwards by referring to the counter.

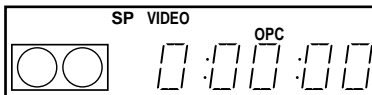

To display the counter on the TV screen, press Ⓜ DISPLAY.

## Notes

- Tapes recorded in the LP mode can not be played back on this VCR.
- The counter resets to “0:00:00” whenever a tape is reinserted.
- The counter stops counting when it comes to a portion with no recording.
- The time counter does not appear on the TV screen when using an NTSC-recorded tape.
- Depending on your TV, the following may occur while playing an NTSC-recorded tape:
  - The picture becomes black and white.
  - The picture shakes.
  - No picture appears on the TV screen.
  - Black streaks appear horizontally on the TV screen.
  - The colour density increases or decreases.
- While setting the menu on the TV screen, buttons for playback on the remote commander do not function.

# Recording TV programmes

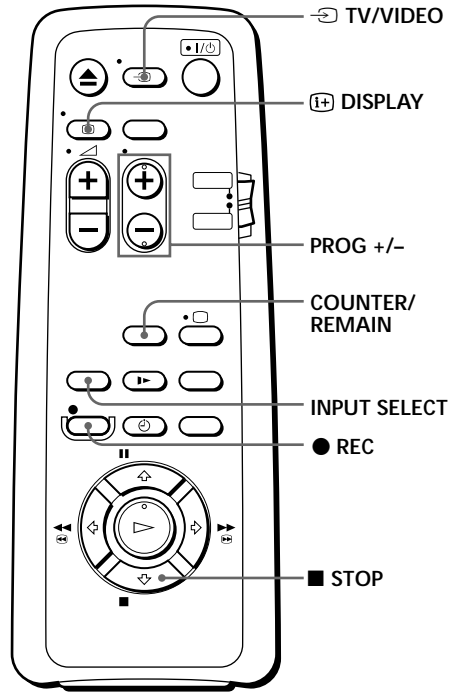

**1** Turn on your TV and set it to the video channel.

**2** Insert a tape with its safety tab in place.

**3**  Press INPUT SELECT until a programme position number appears in the display window.



**4**  Press PROG +/- to select the programme position you want to record.

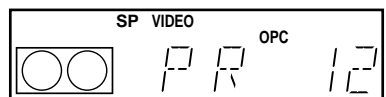

**5**

● REC



Press ● REC to start recording.

The recording indicator lights up red in the display window.

Recording indicator

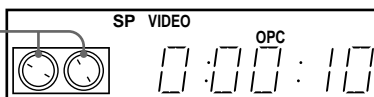

### To stop recording

Press ■ STOP.

### To check the remaining time

Press (+) DISPLAY. With the display on, press COUNTER/REMAIN to check the remaining time. Each time you press COUNTER/REMAIN, the time counter and the remaining time appear alternately. The remaining time with the ⌚ indicator also appears in the display window.



Time counter

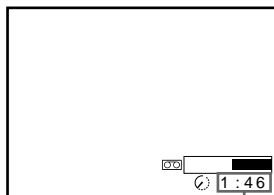

Remaining time

To correctly check the remaining time of the tape, set TAPE LENGTH in the OPTIONS-1 menu according to the tape type you use (see page 45).

### To watch another TV programme while recording

- 1 Press ⇐ TV/VIDEO to turn off the VIDEO indicator in the display window.
- 2 Select another programme position on the TV.

### To save a recording

To prevent accidental erasure, break off the safety tab as illustrated. To record on a tape again, cover the tab hole with adhesive tape.

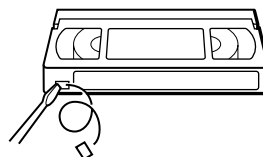

Safety tab

continued

---

## ***Recording TV programmes (continued)***

### **Tips**

- You can select a video source from the LINE-1 (TV) connector also using the INPUT SELECT button.
- The display appears on the TV screen indicating information about the tape, but the information won't be recorded on the tape.
- If you don't want to watch TV while recording, you can turn off the TV.

### **Notes**

- The display does not appear during still (pause) mode or slow-motion playback.
- The display will not appear while playing an NTSC-recorded tape.
- If a tape has portions recorded in both PAL and NTSC systems, the time counter reading will not be correct. This discrepancy is due to the difference between the counting cycles of the two video systems.
- When you insert a non-standard commercially available tape, the remaining time may not be correct.
- The remaining time is intended for rough measurement only.
- About 30 seconds after the tape begins playback, the tape remaining time will be displayed.

# Recording TV programmes using the timer

You can preset up to eight programmes at a time.

Before you start...

- Check that the VCR clock is set to the correct time and date.
- Insert a tape with its safety tab in place. Make sure the tape is longer than the total recording time.
- Turn on your TV and set it to the video channel.

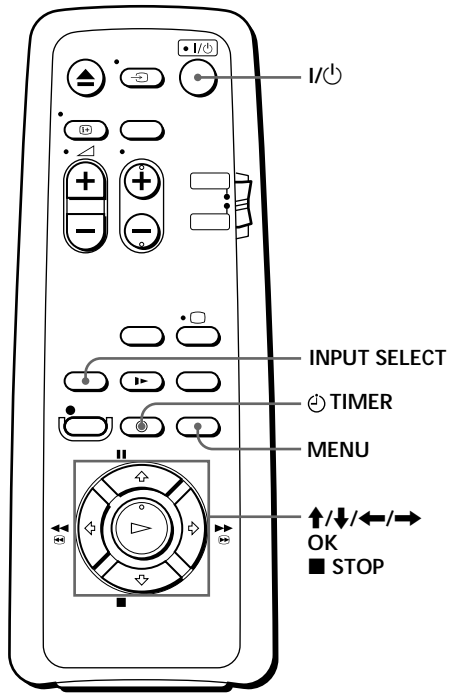

1



Press TIMER.

The TIMER menu appears on the TV screen.

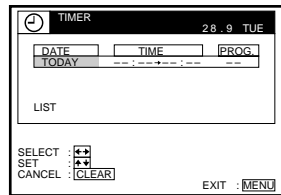

continued

## Recording TV programmes using the timer (continued)

2



Set the date, start and stop times, and programme position:

- 1 Press **→** to highlight each item in turn.
- 2 Press **↑/↓** to set each item.

To correct a setting, press **←** to return to that setting and reset.

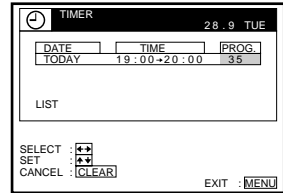

- To record the same programme every day or the same day every week, see “Daily/weekly recording” below.
- To record from a source connected to the LINE-1 (TV) connector, press INPUT SELECT to display “L1” in the “PROG.” position.

INPUT SELECT



3



Press MENU to exit the menu.

4



Press **I/⏻** to turn off the VCR.

The **⏻** indicator appears in the display window and the VCR stands by for recording.

To record from a source, leave the connected equipment switched on.

### To stop recording

To stop the VCR while recording, press **■ STOP**.

### Daily/weekly recording

In step 2 above, press **↓** to select the recording pattern. Each time you press **↓**, the indication changes as shown below. Press **↑** to change the indication in reverse order.

- TODAY → SUN-SAT (Sunday to Saturday) → MON-SAT (Monday to Saturday)
- MON-FRI (Monday to Friday) → SAT (every Saturday) .....
- MON (every Monday) → SUN (every Sunday) → 1 month later
- (dates count down) → TOMORROW → TODAY



### To use the VCR after setting the timer

To use the VCR before a timer recording begins, just press  $I/\odot$ . The  $\odot$  indicator turns off and the VCR switches on. Remember to press  $I/\odot$  to reset the VCR after using the VCR.

You can also do the following tasks while the VCR is recording:

- Reset the counter.
- Display tape information on the TV screen.
- Check the timer settings.
- Watch another TV programme.

### Tips

- To set the programme position, you can also use the PROG +/- buttons.
- To confirm, change, or clear the programme setting, press  $\leftarrow/\rightarrow$  to choose LIST, then press OK after step 2. For details, see step 3 in “Checking/changing/cancelling timer settings” (page 37).

### Note

- The  $\odot$  indicator flashes in the display window when you press  $I/\odot$  with no tape inserted.

# Playing/searching at various speeds

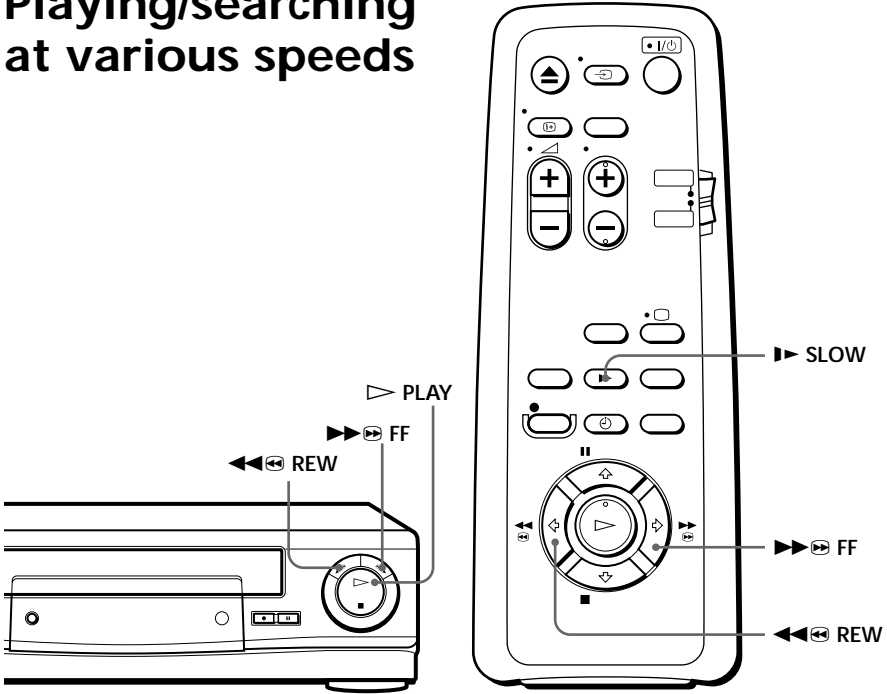

Playback options	Operation
View the picture during fast-forward or rewind	During fast-forward, hold down ►►►► FF. During rewind, hold down ◄◄◄◄ REW.
Play at high speed	<ul style="list-style-type: none"> <li>• During playback, press ►►►► FF or ◄◄◄◄ REW <u>on the remote commander</u>.</li> <li>• During playback, hold down ►►►► FF or ◄◄◄◄ REW. When you release the button, normal playback resumes.</li> </ul>
Play in slow motion	During playback, press ►► SLOW.
Play frame by frame	During pause, press ►►►► FF or ◄◄◄◄ REW <u>on the remote commander</u> . Hold down ►►►► FF or ◄◄◄◄ REW to play one frame each second.
Rewind and start play	During stop, press ▷ PLAY <u>on the VCR</u> while holding down ◄◄◄◄ REW <u>on the VCR</u> .

---

## To resume normal playback

Press ▷ PLAY.

### Tip

- Adjust the picture using the TRACKING +/- buttons if:
  - Streaks appear while playing in slow motion.
  - Bands appear at the top or bottom while pausing.
  - The picture shakes while pausing.

To set tracking to the centre position, press both buttons (+/-) at the same time.

### Notes

- The sound is muted during these operations.
- The picture may have a snow when playing at high speed in reverse.

# Setting the recording duration time

After starting recording in the normal way, you can have the VCR stop recording automatically after a specified duration.

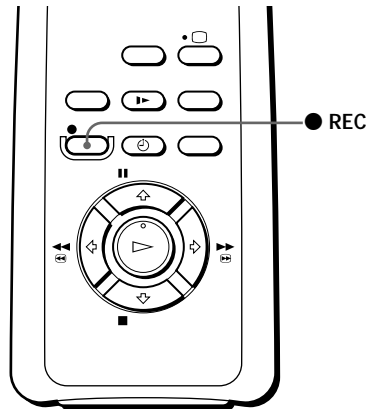

- 1 While recording, press ● REC.  
The ⏻ indicator appears in the display window.

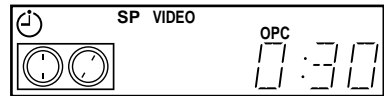

- 2 Press ● REC repeatedly to set the duration.  
Each press advances the time in increments of 30 minutes.

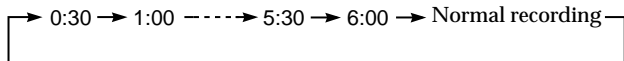

The tape counter decreases minute by minute to 0:00, then the VCR stops recording and turns off automatically.

## To extend the duration

Press ● REC repeatedly to set a new duration.

## To cancel the duration

Press ● REC repeatedly until the ⏻ indicator disappears and the VCR returns to normal recording mode.

## To stop recording

To stop the VCR while recording, press ■ STOP.

## Note

- You cannot display the current tape time in the display window when setting the recording duration.

# Checking/ changing/ cancelling timer settings

Before you start...

- Turn on your TV and set it to the video channel.

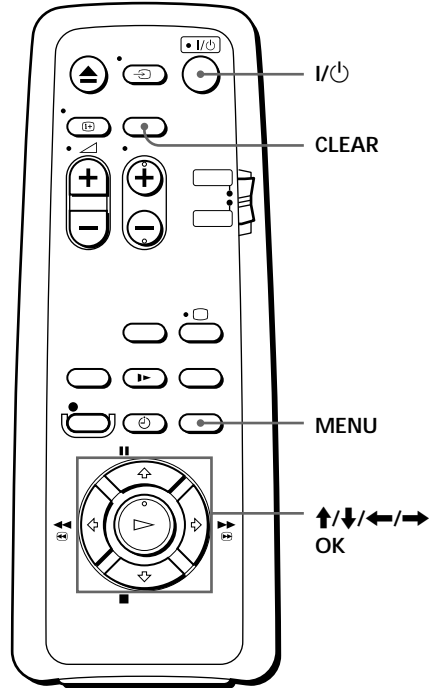

- 1 Press I/⏻ to turn on the VCR.
- 2 Press MENU, then press ↑/↓ to highlight LISTS and press OK.
- 3 Press ↑/↓ to highlight TIMER LIST, then press OK:
  - If you want to change or cancel a setting, go on to the next step.
  - If you do not need to change or cancel the settings, press MENU, then turn off the VCR to return to recording standby.

TIMER LIST			28.9 TUE
DATE	TIME	PROG.	
TODAY	19:00→20:00	35	
30.9	20:00→21:00	20	
2.10	10:00→11:30	60	
MON-FRI	14:00→15:00	42	
SUN	6:30→7:00	L1	
---	---	---	
---	---	---	
---	---	---	

PRETURN : ←→  
 SELECT : OK  
 SET : OK  
 CANCEL : CLEAR  
 EXIT : MENU

continued

## Checking/changing/cancelling timer settings (continued)

- 4 Press **↑/↓** to select the setting you want to change or cancel, then press **OK**.

The selected setting appears in the **TIMER** menu.

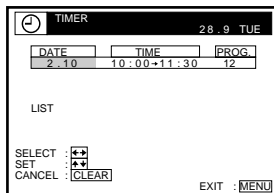

- 5
- To change the setting, press **←/→** to highlight the item you want to change, and press **↑/↓** to reset it.
  - To cancel the setting, press **CLEAR**.
- 6 Press **MENU**.

If any settings remain, turn off the VCR to return to recording standby.

### When the timer settings overlap

The programme that starts first has priority and the second programme starts recording only after the first programme has finished. If the programmes start at the same time, the programme listed first in the menu has priority.

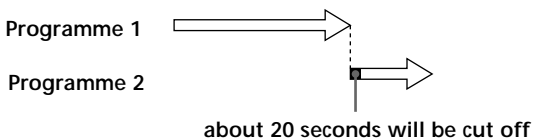
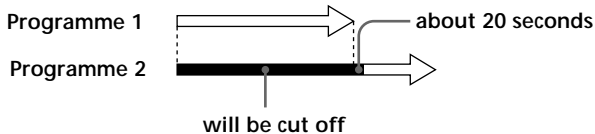

# Searching using the Smart Search function

If you record multiple programmes on a tape, use the Smart Search function to see what has been recorded on your tape. You can see information such as date, time, and channel of programmes recorded on a tape. You can also start playback directly from the selected programme using the SMART SEARCH screen.

All programmes are listed on the screen, regardless of how the programme was recorded.

The data of the last tape inserted into the VCR is automatically stored in memory. If you want to recall the latest data screen, select LATEST DATA in the SMART SEARCH screen (see page 40).

Before you start...

- Turn on your TV and set it to the video channel.

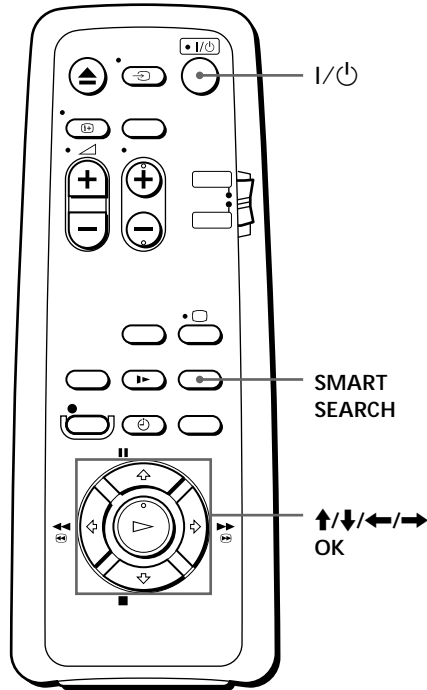

- 1 After recording, press I/⏻ to turn on the VCR.
- 2 Press SMART SEARCH.
- 3 Press ↑/↓/←/→ to select the programme you want to start viewing.

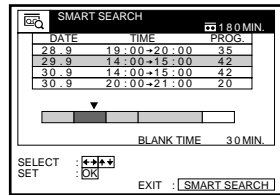

- 4 Press OK.  
The VCR starts searching, and playback starts automatically from the beginning of the selected programme.

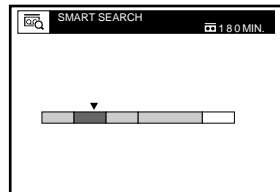

continued

## Searching using the Smart Search function (continued)

To stop searching

Press ■ STOP.

To exit the SMART SEARCH screen

Press SMART SEARCH.

To record in a blank space

Blank space on the tape will appear as a blank row in the SMART SEARCH screen. Select the blank row in step 3, then press OK. The VCR rewinds/fast-forwards the tape to the beginning of the blank space, then stops. Start recording.

### To recall the latest data screen after you remove the tape

You can display the data of the last tape used to record a programme, even after you have removed the tape.

If you reinsert the tape and record additional programmes, be sure to select LATEST DATA. Otherwise, all of the data for the tape is deleted.

- 1 Reinsert the last tape that you used to record a programme.
- 2 Press SMART SEARCH.

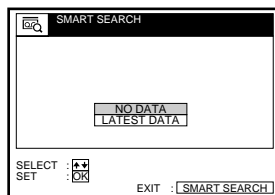

- 3 Press ↑/↓ to highlight LATEST DATA.

If you want to reset the latest data screen, highlight NO DATA and press OK, then record a programme.

- 4 Press OK.

The latest data stored in the VCR's memory is displayed.

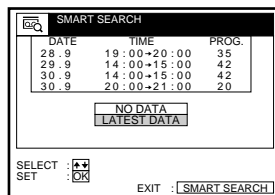

#### Tips

- You can store information for up to 24 programmes on a single list.
- While recording, you can display the SMART SEARCH screen using the SMART SEARCH button. If you decide to stop recording, press SMART SEARCH to make the SMART SEARCH screen disappear first. Then press ■ STOP.



## Notes

- If you begin recording a programme "D" from the middle of a previously recorded programme "A" and into another previously recorded programme "B," the Smart Search information for the second programme "B" which is recorded over is deleted.

### Originally recorded programmes



### Recording the programme "D" over the programme "A" and "B"

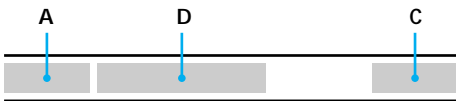

- You cannot use this function unless the clock is set.
- Depending on the tape, the total or remaining time may not appear correctly.
- When recording a short programme (less than 10 minutes), the Smart Search function may not be available or the programme information may not appear. Also, if you record a long programme directly after a short programme, the Smart Search information for the short programme may be deleted.
- Blank space is measured from the end of the last recorded programme to the end of the tape. However, if you eject the tape then make a new recording on the same tape, the original recorded programme(s) is displayed as a blank space.
- If no information is stored in the VCR's memory, LATEST DATA does not appear in the SMART SEARCH screen.

# Adjusting the picture

## Adjusting the tracking

Although the VCR automatically adjusts the tracking when playing a tape (the  indicator flashes in the display window, then goes off), distortion may occur if the tape was recorded in poor condition. In this case, manually adjust the tracking.

During playback, press TRACKING +/- to display the tracking meter. The distortion should disappear as you press one of the two buttons (the  indicator lights up). To resume automatic tracking adjustments, eject the tape and re-insert it.

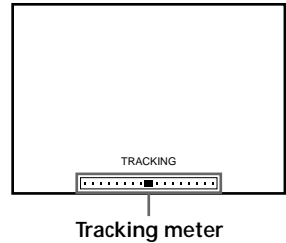

## About the Optimum Picture Control (OPC) function

The Optimum Picture Control (OPC) function automatically improves recording and playback quality by adjusting the VCR to the condition of the video heads and tape. To maintain better picture quality, we recommend that you set OPC to ON in the OPTIONS-1 menu (with the OPC indicator in the display window lit). For details, see page 45.

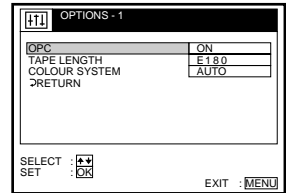

### OPC playback

The OPC function automatically works on all types of tapes, including rental tapes and tapes that were not recorded with OPC.

### OPC recording

Whenever you insert a tape and start recording for the first time, the VCR adjusts to the tape using the OPC function (the OPC indicator flashes rapidly). This adjustment is retained until the tape is ejected.

### To deactivate the OPC function

Set OPC to OFF in the OPTIONS-1 menu. The OPC indicator in the display window goes off.

---

### Tip

- To set tracking to the centre position, press the TRACKING + and – buttons at the same time.

### Notes

- You can adjust the tracking for the NTSC-recorded tape but the tracking meter won't be displayed.
- There is a delay about ten seconds before the VCR actually starts recording while the VCR analyses the tape. To avoid the delay, first set the VCR to recording pause (the OPC indicator flashes slowly) and press ● REC to have the VCR analyse the tape (the OPC indicator flashes rapidly). After the OPC indicator stops flashing, press ■■ PAUSE to start recording immediately. If you want to start recording quickly without using the OPC function, first set the VCR to recording pause (the OPC indicator flashes slowly) and press ■■ PAUSE to start recording.

# Changing menu options

- 1 Press MENU, then select OPTIONS and press OK.

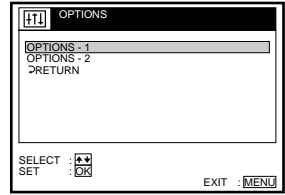

- 2 Press **↑/↓** to highlight OPTIONS-1 or OPTIONS-2, then press OK.

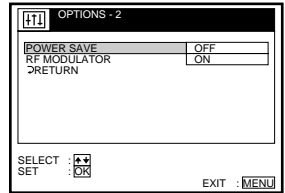
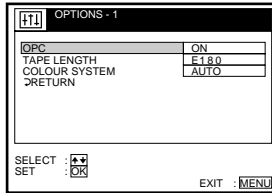

- 3 Press **↑/↓** to select the option, then press OK.
- 4 Press **↑/↓** to change the setting, then press OK.
- 5 Press MENU to return to the original screen.

## Menu choices

Initial settings are indicated in bold print.

### OPTIONS-1

Menu option	Set this option to
OPC	<ul style="list-style-type: none"><li>• <b>ON</b> to switch on the OPC (Optimum Picture Control) function and improve picture quality.</li><li>• <b>OFF</b> to switch off OPC.</li></ul>
TAPE LENGTH	<ul style="list-style-type: none"><li>• <b>E180</b> to use an E-180 or shorter type tape.</li><li>• <b>E195</b> to use an E-195 type tape.</li><li>• <b>E240</b> to use an E-240 type tape.</li><li>• <b>E300</b> to use an E-300 type tape.</li></ul>
COLOUR SYSTEM	<ul style="list-style-type: none"><li>• <b>AUTO</b> to set the colour system automatically.</li><li>• <b>PAL</b> to play back a tape recorded in the PAL colour system.</li><li>• <b>MESECAM</b> to play back a tape recorded in the MESECAM colour system.</li></ul> <p>For details, see page 26.</p>

### OPTIONS-2

Menu option	Set this option to
POWER SAVE	<ul style="list-style-type: none"><li>• <b>ON</b> to turn off the indicators in the display window to conserve the VCR power.</li><li>• <b>OFF</b> to turn on the indicators in the display window while the VCR is standing by.</li></ul>
RF MODULATOR	<ul style="list-style-type: none"><li>• <b>ON</b> if you connect the VCR to your TV using only the aerial cable.</li><li>• <b>OFF</b> if you connect the VCR to your TV using the EURO-AV cable.</li></ul>

#### Note

- When you set a timer recording, the indicators in the display window remain on, even though POWER SAVE is set to ON.

# Editing with another VCR

How to connect to record on this VCR

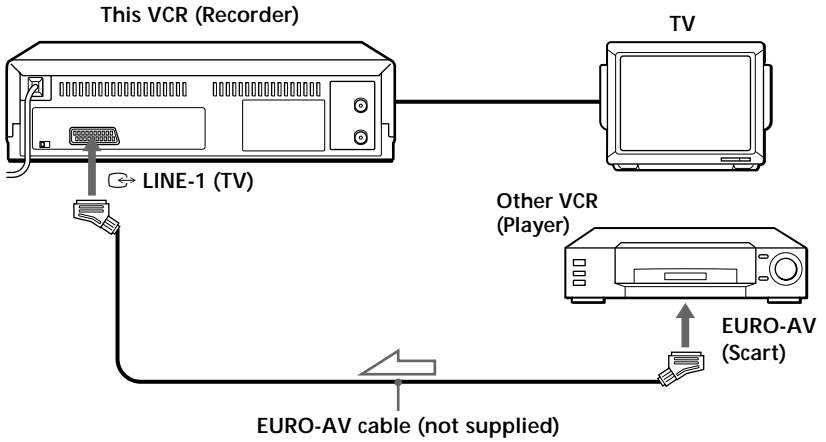

 : Signal flow

## Operation (when recording on this VCR)

### Before you start editing

- Turn on your TV and set it to the video channel.
- Press INPUT SELECT to display “L1” in the display window.

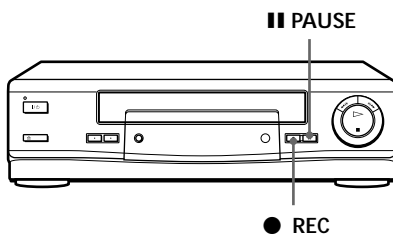

- 1** Insert a source tape with its safety tab removed into the other (playback) VCR. Search for the point to start playback and set it to playback pause.
- 2** Insert a tape with its safety tab in place into this (recording) VCR. Search for the point to start recording and press **|| PAUSE**.
- 3** Press **● REC** on this VCR to set it to recording pause.
- 4** To start editing, press the **|| PAUSE** buttons on both VCRs at the same time.

### To stop editing

Press the **■ STOP** buttons on both VCRs.

### Tip

- To cut out unwanted scenes while editing, press **|| PAUSE** on this VCR when an unwanted scene begins. When it ends, press **|| PAUSE** again to resume recording.

### Note

- If you start editing following the procedure above, the VCR won't start recording with the OPC function. To record a tape with the OPC function, press **● REC** again during recording pause in step 3 so the VCR analyses the tape. Then, when you start editing in step 4, press **|| PAUSE** after the OPC indicator stops flashing. If you press **|| PAUSE** before the OPC indicator stops flashing, the OPC function is cancelled.

# Troubleshooting

If you have any questions or problems not covered below, please consult your nearest Sony service facility.

	Symptom	Remedy
Power	The I /⏻ ON/STANDBY switch does not function.	<ul style="list-style-type: none"> <li>• Connect the mains lead to the mains securely.</li> </ul>
	The power is turned on but the VCR does not operate.	<ul style="list-style-type: none"> <li>• Moisture condensation occurs. Turn the power off, unplug the mains lead and leave the VCR to dry for over three hours.</li> </ul>
Clock	The clock has stopped and “-:- -” lights in the display window.	<ul style="list-style-type: none"> <li>• The clock stops if the VCR is disconnected from the mains for more than one hour. Reset the clock (and timer).</li> </ul>
	The playback picture does not appear on the TV screen.	<ul style="list-style-type: none"> <li>• Make sure the TV is set to the video channel. If you are using a monitor, set it to video input.</li> <li>• If the VCR is connected to the TV only with the aerial cable, make sure that RF MODULATOR in the OPTIONS-2 menu is set to ON.</li> </ul>
Playback	The picture is not clear.	<ul style="list-style-type: none"> <li>• Adjust the tracking with the TRACKING +/- buttons.</li> <li>• The video heads are dirty (see below). Clean the video heads using the Sony T-25CLD, E-25CLDR, or T-25CLW video head cleaning cassette. If these cleaning cassettes are not available in your area, have the heads cleaned at your nearest Sony service facility (a standard service charge will be required). Do not use a commercially available liquid type cleaning cassette other than Sony's, as it may damage the video heads.</li> <li>• The video heads may have to be replaced. Consult your local Sony service facility for more information.</li> </ul>

## Symptoms caused by contaminated video heads

- Normal picture
- Rough picture
- Unclear picture
- No picture (or black & white screen appears)



initial  
contamination



terminal



	Symptom	Remedy
Playback	The picture is no colour.	<ul style="list-style-type: none"> <li>The COLOUR SYSTEM option in the OPTIONS-1 menu is set to the wrong position. Set the option to conform to the system that the tape was recorded.</li> </ul>
	The picture rolls vertically during picture search.	<ul style="list-style-type: none"> <li>Adjust the vertical hold control on the TV or monitor.</li> </ul>
	The picture has no sound.	<ul style="list-style-type: none"> <li>The tape is defective.</li> </ul>
Recording	No TV programme appears on the TV screen.	<ul style="list-style-type: none"> <li>Make sure the TV is set to the video channel. If you are using a monitor, set it to video input.</li> <li>If the VCR is connected to the TV using only the aerial cable, make sure that RF MODULATOR in the OPTIONS-2 menu is set to ON.</li> <li>Select the correct source with the INPUT SELECT button. Select a programme position when recording TV programmes; select "L1" when recording from other equipment.</li> </ul>
	TV reception is poor.	<ul style="list-style-type: none"> <li>Adjust the TV aerial.</li> <li>Make sure the TV system is correctly set for your TV.</li> <li>Make sure SYSTEM (B/G or D/K) in the TUNER menu is set to the same system in your local area.</li> </ul>
	The tape starts playing as soon as it is inserted.	<ul style="list-style-type: none"> <li>The safety tab has been removed. To record on this tape, cover the tab hole.</li> </ul>
	The tape is ejected when you press ● REC.	<ul style="list-style-type: none"> <li>Check that the safety tab has not been removed.</li> </ul>
	Nothing happens when you press ● REC.	<ul style="list-style-type: none"> <li>Make sure the tape is not at its end.</li> </ul>
Timer recording	The timer does not operate.	<ul style="list-style-type: none"> <li>Check that the clock is set.</li> <li>Make sure a tape has been inserted.</li> <li>Check that the safety tab has not been removed.</li> <li>Make sure the tape is not at its end.</li> <li>Make sure a programme has been set for timer recording.</li> <li>Make sure your timer settings have not already passed the current time.</li> <li>The clock stops if the VCR is disconnected from the mains for more than one hour. Reset the clock and timer.</li> </ul>

continued

---

## Troubleshooting (continued)

	Symptom	Remedy
Others	A tape cannot be inserted.	<ul style="list-style-type: none"><li>• Check that a tape isn't already in the tape compartment.</li></ul>
	The remote commander does not function.	<ul style="list-style-type: none"><li>• Make sure you are pointing the remote commander at the remote sensor on the VCR.</li><li>• Replace all the batteries in the remote commander with new ones if they are weak.</li><li>• Make sure the <b>TV</b>/<b>VIDEO</b> remote control switch is set correctly.</li></ul>
	The tracking meter does not appear on the TV screen.	<ul style="list-style-type: none"><li>• The recording condition of the tape is very poor and tracking cannot be adjusted.</li><li>• The tracking meter does not appear when playing back an NTSC-recorded tape.</li></ul>
	The VCR needs to be cleaned.	<ul style="list-style-type: none"><li>• Clean the cabinet, panel and controls with a dry, soft cloth, or a soft cloth slightly moistened with a mild detergent solution. Do not use any type of solvent, such as alcohol or benzine.</li></ul>

---

# Specifications

## System

Channel coverage

PAL (B/G, D/K)

VHF E2-E12, R1-R12

UHF E21-E69, R21-R69

CATV S1-S41, S01-S05

RF output signal

UHF channels 21 to 69

Aerial out

75-ohm asymmetrical aerial socket

## Inputs and outputs

↳ LINE-1 (TV)

21-pin

Video input: pin 20

Audio input: pins 2 and 6

Video output: pin 19

Audio output: pins 1 and 3

## General

Power requirements

220 – 240 V AC, 50 Hz

Power consumption

20 W

Operating temperature

5°C to 40°C

Storage temperature

-20°C to 60°C

Dimensions

Approx. 355 × 96 × 285 mm (w/h/d)

including projecting parts and controls

Mass

Approx. 3.8 kg

## Supplied accessories

Remote commander (1)

R6 (size AA) batteries (2)

Aerial cable (1)

Design and specifications are subject to change without notice.

# Index to parts and controls

Refer to the pages indicated in parentheses ( ) for details.

## Front panel

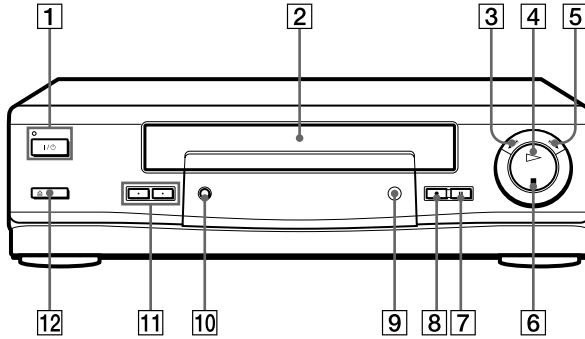

- |   |   |
|---|---|
| <b>1</b> I/⏻ ON/STANDBY switch/<br>indicator (10) | <b>8</b> ● REC (record) button (29, 36, 47)                               |
| <b>2</b> Tape compartment                         | <b>9</b> Remote sensor (5)  |
| <b>3</b> ◀◀⏮ REW (rewind) button (26, 34)         | <b>10</b> AUTO SET UP/<br>RF (Radio Frequency) CHANNEL<br>button (10, 12) |
| <b>4</b> ▷▶⏭ PLAY button (25, 34)                 | <b>11</b> PROGRAM/TRACKING +/-<br>buttons (11, 35, 42)                    |
| <b>5</b> ▶▶⏩ FF (fast-forward) button (26,<br>34) | <b>12</b> ≡ EJECT button (26)   |
| <b>6</b> ■ STOP button (26, 47)                   |   |
| <b>7</b>    PAUSE button (26, 47)                 |   |

## Display window

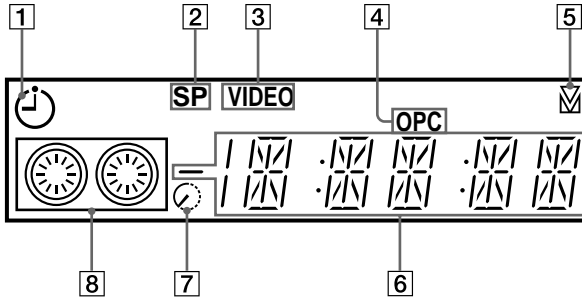

- |  |   |
|--|---|
| <b>1</b> Timer indicator (32)                            | <b>6</b> Time counter/clock/line/<br>programme position indicator (26,<br>28, 47) |
| <b>2</b> Tape speed indicator                            | <b>7</b> Remaining time indicator (29)  |
| <b>3</b> VIDEO indicator (9, 29)                         | <b>8</b> Tape/recording indicator (28)  |
| <b>4</b> OPC (Optimum Picture Control)<br>indicator (42) |   |
| <b>5</b> Tracking indicator (42)                         |   |

continued

## *Index to parts and controls (continued)*

### Rear panel

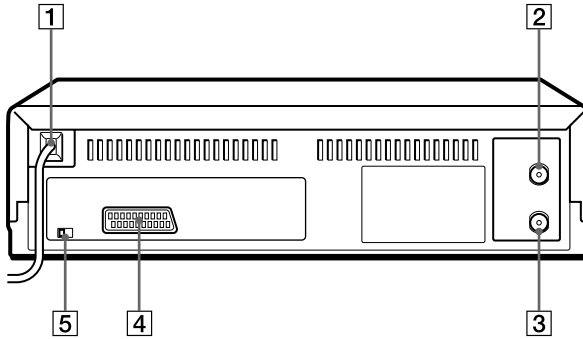

- |  |  |
|--|--|
| <b>1</b> Mains lead (7, 8)                             | <b>4</b> ↻ LINE-1 (TV)<br>↻ LIGNE-1 (TV) connector (9, 46) |
| <b>2</b> AERIAL IN<br>ANTENNE ENTREE connector (7, 8)  | <b>5</b> NTSC PB (Play Back) switch (26)                   |
| <b>3</b> AERIAL OUT<br>ANTENNE SORTIE connector (7, 8) |  |

## Remote commander

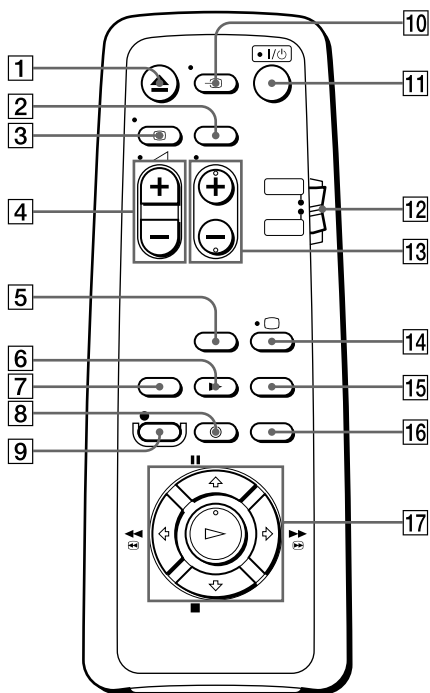

- 1 ▲ EJECT button (26)
- 2 CLEAR button (38)
- 3 DISPLAY button (29)
- 4 (volume) +/- buttons (for TV) (6)
- 5 COUNTER/REMAIN button (29)
- 6 SLOW button (34)
- 7 INPUT SELECT button (28, 32, 47)
- 8 TIMER button (31)
- 9 ● REC (record) button (29, 36)
- 10 TV/VIDEO button (6, 29)
- 11 I/O (on/standby) switch (6, 32)
- 12 TV/VIDEO remote control switch (5)
- 13 PROG (programme) +/- buttons (6, 18, 28)
- 14 TV power on/TV mode select button (for TV) (6)
- 15 SMART SEARCH button (39)
- 16 MENU button (14, 37)
- 17 PAUSE/▲ button (14, 26)  
 STOP/▼ button (14, 26)  
 REW (rewind)/← button (26, 34)  
 FF (fast-forward)/→ button (26, 34)  
 PLAY/OK button (14, 25)

---

# Index

## A, B

- Adjusting
  - picture 20, 42
  - tracking 42
- Aerial hookup 7
- AFT (Auto Fine Tuning) 20
- Auto Set Up 12

## C

- Changing the programme position 21
- Cleaning the video heads 48
- Clock setting 14
- Colour system
  - compatible colour systems 2
  - setting 26
- Connecting
  - the VCR and your TV 7
  - to a TV with a EURO-AV connector 8
- Counter 26

## D

- Disabling the programme position 23
- Dubbing. *See* Editing

## E, F, G, H, I, J, K

- Editing 46
- EURO-AV connection 8

## L, M, N

- Language selecting 16
- LP mode 27

## O

- OPC (Optimum Picture Control) 42
- Optional setting 44

## P, Q

- Picture adjustment. *See* Adjusting
- Playback 25
  - at various speeds 34
  - slow motion 34
- Power save 45
- Presetting channels 17

## R

- Recording 28
  - saving 29
  - timer setting 31
  - while watching another programme 29
- RF channel 10

## S

- Safety tab 29
- Searching
  - at various speeds 34
  - using the Smart Search function 39
- Smart Search 39

## T, U, V, W, X, Y, Z

- Timer setting 31
  - cancelling 37
  - changing 37
  - checking 37
  - daily/weekly recording 32
- Tracking adjustment. *See* Adjusting