

Video Cassette Recorder

Operating Instructions

GB



Hi-Fi

G-CODE

KARAOKE

SLV-K877TK

WARNING

To prevent fire or shock hazard, do not expose the unit to rain or moisture.

To avoid electrical shock, do not open the cabinet. Refer servicing to qualified personnel only.

The mains lead must only be changed at a qualified service shop.

Precautions

Safety

- This unit operates on 110 – 240 V AC, 50/60 Hz. Check that the unit's operating voltage is identical with your local power supply.
- If anything falls into the cabinet, unplug the unit and have it checked by qualified personnel before operating it any further.
- The unit is not disconnected from the mains as long as it is connected to the mains, even if the unit itself has been turned off.
- Unplug the unit from the mains if you do not intend to use it for an extended period of time. To disconnect the lead, pull it out by the plug, never by the lead.

Installing

- Allow adequate air circulation to prevent internal heat buildup.
- Do not place the unit on surfaces (rugs, blankets, etc.) or near materials (curtains, draperies) that may block the ventilation slots.
- Do not install the unit near heat sources such as radiators or air ducts, or in a place subject to direct sunlight, excessive dust, mechanical vibration or shock.
- Do not install the unit in an inclined position. It is designed to be operated in a horizontal position only.
- Keep the unit and cassettes away from equipment with strong magnets, such as microwave ovens or large loudspeakers.
- Do not place heavy objects on the unit.
- If the unit is brought directly from a cold to a warm location, moisture may condense inside the VCR and cause damage to the video head and tape. When you first install the unit, or when you move it from a cold to a warm location, wait for about one hour before operating the unit.

Caution

Television programmes, films, video tapes and other materials may be copyrighted. Unauthorized recording of such material may be contrary to the provisions of the copyright laws. Also, use of this recorder with cable television transmission may require authorization from the cable television transmitter and/or programme owner.

Compatible colour systems

- This VCR is designed to record and play back using the PAL (B/G and D/K), MESECAM (B/G and D/K), and NTSC colour systems.
- Recording of video sources based on other colour systems cannot be guaranteed.

Table of contents

Getting Started

- 4 Step 1: Unpacking
- 5 Step 2: Setting up the remote commander
- 6 Step 3: Connecting the VCR
- 8 Step 4: Tuning your TV to the VCR
- 10 Step 5: Setting up the VCR with EASY SET UP
- 13 Manual setup —
 - Selecting a language, Presetting channels, Setting up G-CODE*, Changing/disabling programme positions, Setting the clock

Basic Operations

- 27 Playing a tape
- 31 Recording TV programmes
- 34 Recording TV programmes using G-CODE
- 37 Setting the timer manually

Additional Operations

- 40 Playing/searching at various speeds
- 42 Recording TV programmes using the quick timer
- 43 Checking/changing/cancelling timer settings
- 44 Recording stereo and bilingual programmes
- 46 Karaoke sing-along
- 55 Searching with the AMS or index function
- 57 Enjoying the surround sound (Virtual Sound)
- 58 Adjusting the picture
- 59 Changing menu options

Editing

- 60 Connecting to a VCR or stereo system
- 61 Basic editing
- 62 Audio dubbing

Additional Information

- 65 Troubleshooting
- 68 Specifications
- 69 Index to parts and controls
- 75 Index

* G-CODE is a trademark applied for by Gemstar Development Corp. G-CODE system is manufactured under license from Gemstar Development Corporation.

Step 1

Unpacking

Check that you have received the following items with the VCR:

- Remote commander

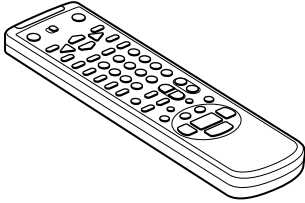

- Audio/video cable (3-phono to 3-phono)

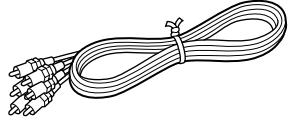

- R6 (size AA) batteries

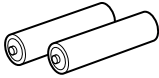

- Microphone

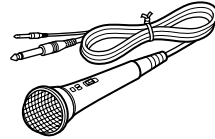

- Aerial cable

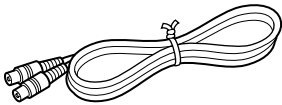

Step 2

Setting up the remote commander

Inserting the batteries

Insert two R6 (size AA) batteries by matching the + and – on the batteries to the diagram inside the battery compartment.

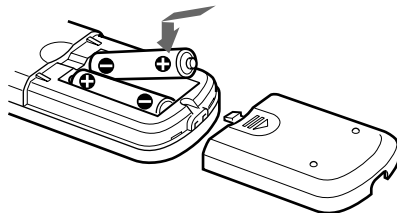

Using the remote commander

You can use this remote commander to operate this VCR and a Sony TV. Buttons on the remote commander marked with a dot (•) can be used to operate your Sony TV.

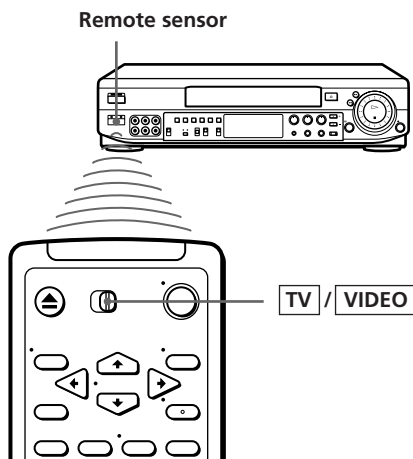

To operate	Set TV / VIDEO to
the VCR	VIDEO and point at the remote sensor on the VCR
a Sony TV	TV and point at the remote sensor on the TV

Notes

- The TV/VIDEO button selects an input source of the TV from aerial in or line in. The button does not control this VCR.
- With normal use, the batteries should last about three to six months.
- If you do not use the remote commander for an extended period of time, remove the batteries to avoid possible damage from battery leakage.
- Do not use a new battery with an old one.
- Do not mix different types of batteries.

Step 3

Connecting the VCR

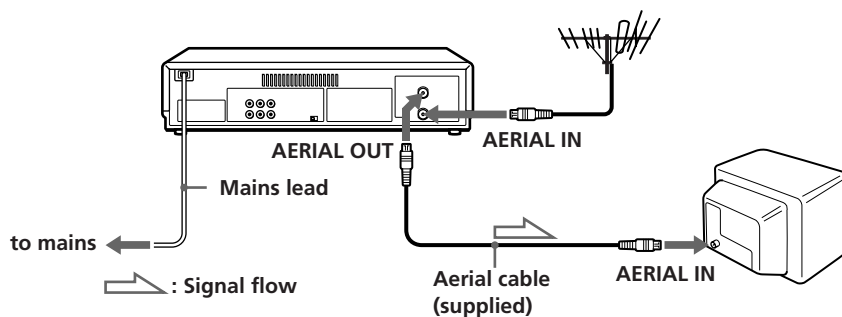

1

Disconnect the aerial cable from your TV and connect it to AERIAL IN on the rear panel of the VCR.

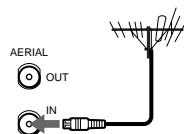

2

Connect AERIAL OUT of the VCR and the aerial input of your TV using the supplied aerial cable.

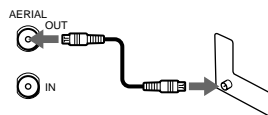

3

Connect the mains lead to the mains.

Additional connections

To a TV that has phono type audio/video input jacks

This additional connection improves picture and sound quality. Connect the TV as shown on the right.

If you want to use the Trinitron TV Synchro Play function (see page 30), this connection is necessary. (If your TV has two or more inputs, connect the audio/video cable to the VIDEO IN 1 jacks.)

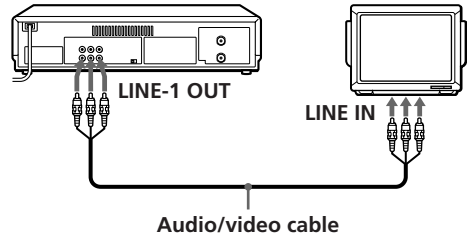

To a stereo system

You can improve sound quality by connecting a stereo system as shown on the right.

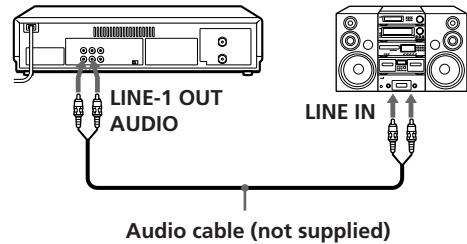

Step 4

Tuning your TV to the VCR

If you have connected your VCR to the TV using the audio/video cable, skip this step.

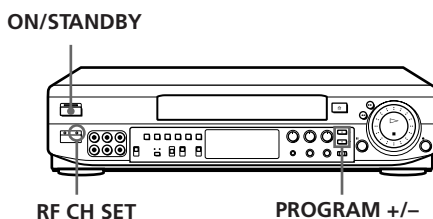

-
- 1**  Press ON/STANDBY to turn on the VCR.

-
- 2**  Press RF CH SET on the VCR with a ball-point pen, etc.
The factory-preset RF channel appears in the display window.
The VCR signal is output through this channel to the TV.

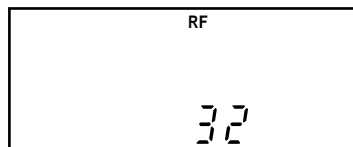

-
- 3** Turn on your TV and select a programme position for the VCR picture.
This channel will now be referred to as the video channel.

4

RF CH
SET
○

Press RF CH SET.

The TV system indicator appears in the display window.

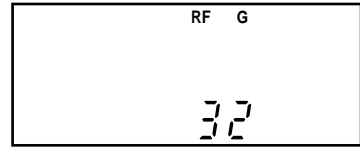
 +
PROGRAM
 -

Press PROGRAM +/- to select the desired TV system.

If your TV system is	Select
B/G	G
D/K	K

5

Tune the TV to the same channel as that shown in the display window so that the picture on the right appears on the TV screen.

Refer to your TV manual for tuning instructions.

If the picture does not appear clearly, see "To obtain a clear picture from the VCR" below.



6

RF CH
SET
○

Press RF CH SET.

You have now tuned your TV to the VCR. From now on, whenever you want to play a tape, set the TV to the video channel.

To check to see if the TV tuning is correct

Set the TV to the video channel and press PROGRAM +/- on the VCR. If the TV screen changes to a different programme each time you press PROGRAM +/-, the TV tuning is correct.

To obtain a clear picture from the VCR

If the picture does not appear clearly in step 5 above, press PROGRAM +/- in step 5, so that another RF channel appears. Then tune the TV to the new RF channel until a clear picture appears.

Note

- If you set the wrong TV system, you may have no sound or sound may be distorted (noisy sound).

Step 5

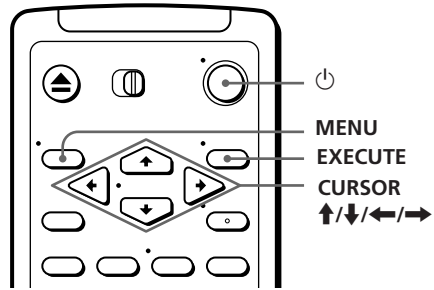

Setting up the VCR with EASY SET UP

Before using the VCR for the first time, set up the VCR using the EASY SET UP function. With this function, you can set the language for the on-screen display, TV channels, guide channels for G-CODE, and the VCR clock, guided by the sequence indicated on the TV screen.

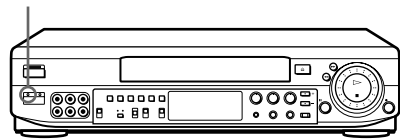

EASY SET UP



- 1  Press  to turn on the VCR.

- 2 Turn on your TV and set it to the video channel.

- 3  Press **EASY SET UP** on the VCR with a ball-point pen, etc.
To cancel the EASY SET UP function, press EASY SET UP again.

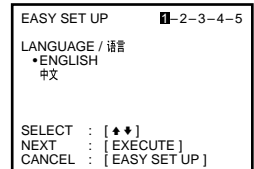

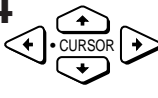
- 4  Press **CURSOR** ↑/↓ to select the desired language, then press **EXECUTE**.
The TV SYSTEM menu appears.

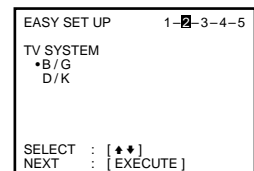

5

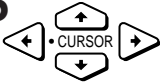

• EXECUTE



Press CURSOR \uparrow/\downarrow to select either B/G or D/K, whichever is applicable in your area, then press EXECUTE.

The VCR starts searching for all the receivable channels.

During presetting, the channel being located is displayed on the screen.

When all the channels are preset, the following screen appears.

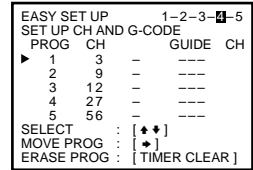
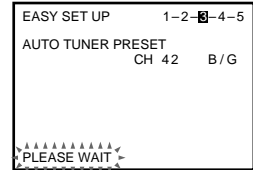

6

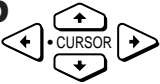

Using CURSOR $\uparrow/\downarrow/\leftarrow/\rightarrow$ set the G-CODE guide channels, change the programme positions of the stations, and disable the unused programme positions. (If not necessary, skip this step.)

The setting procedures are the same as those described in "Manual setup — Setting up G-CODE" on page 19 and "Manual setup — Changing/disabling programme positions" on page 22.

7

• EXECUTE



Press EXECUTE.

The CLOCK SET menu appears.

8

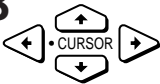

Set the date and time using CURSOR $\uparrow/\downarrow/\leftarrow/\rightarrow$. The setting procedures are the same as those described in "Manual setup—Setting the clock" on page 25.

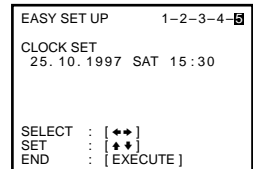

continued

Step 5 : Setting up the VCR with EASY SET UP (continued)

9

• EXECUTE



Press EXECUTE.

A programme position appears on the TV screen.



Note

- Do not exit EASY SET UP while the VCR is presetting channels. If you do, repeat EASY SET UP from the beginning.

Manual setup — Selecting a language

You can change the on-screen display language from the one you selected with the EASY SET UP function.

Before you start...

- Turn on the VCR and the TV.
- Set the TV to the video channel.

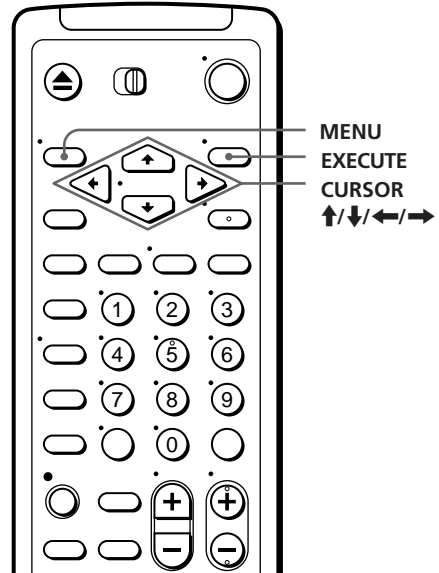

1

• MENU



Press MENU, then press CURSOR \uparrow/\downarrow to move the cursor (\blacktriangleright) to LANGUAGE and press EXECUTE.



• EXECUTE



LANGUAGE / 语言

• ENGLISH
• 中文

SELECT : [\blacktriangle]
END : [EXECUTE]

2

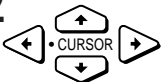

Press CURSOR \uparrow/\downarrow to select the desired language, then press EXECUTE.

• EXECUTE



LANGUAGE / 语言

• ENGLISH
• 中文

选择 : [\blacktriangle]
完毕 : [EXECUTE]

Manual setup — Presetting channels

First, we recommend that you preset the receivable channels in your area using EASY SET UP or using automatic presetting below. Then, if some channels could not be preset automatically, you can preset them manually; if there are any unwanted channels among the preset ones, you can disable the channels.

Before you start...

- Turn on the VCR and the TV.
- Set the TV to the video channel.

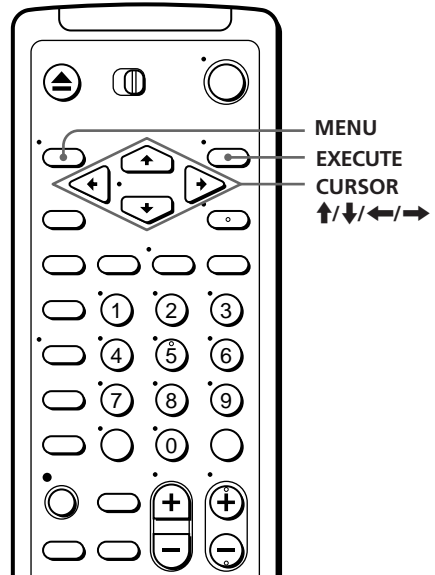

Presetting all receivable channels automatically

If you have preset the channels using the EASY SET UP procedure, skip this procedure.

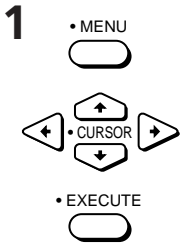

Press MENU, then press CURSOR ↑/↓ to move the cursor (▶) to TUNER PRESET and press EXECUTE.

TUNER PRESET	PROG1
SYSTEM	•B/G D/K
NORMAL / CATV	•NORM CATV
AUTO PRESET	
▶ CHANNEL SET	2
AFT	•ON OFF
FINE TUNING	
SELECT : [♦♦]	
SET : [♦♦]	

2

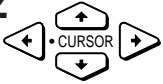

Press CURSOR $\uparrow/\downarrow/\leftarrow/\rightarrow$ to move the cursor (\blacktriangleright) to SYSTEM, then select either B/G or D/K, whichever is applicable in your area. If SYSTEM is set to the wrong position, the sound will be distorted or noisy.

TUNER PRESET	PROG1
\blacktriangleright SYSTEM	\bullet B/G D/K
NORMAL / CATV	\bullet NORM CATV
AUTO PRESET	
CHANNEL SET	2 ON OFF
AFT	
FINE TUNING	
SELECT : [\blacktriangleleft \blacktriangleright]	
SET : [\blacktriangleleft \blacktriangleright]	

3

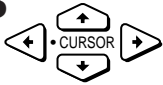

Press CURSOR $\uparrow/\downarrow/\leftarrow/\rightarrow$ to move the cursor (\blacktriangleright) to NORMAL/CATV, then select NORM.

To preset CATV channels, select CATV.

TUNER PRESET	PROG1
SYSTEM	\bullet B/G D/K
\blacktriangleright NORMAL / CATV	\bullet NORM CATV
AUTO PRESET	
CHANNEL SET	2 ON OFF
AFT	
FINE TUNING	
SELECT : [\blacktriangleleft \blacktriangleright]	
SET : [\blacktriangleleft \blacktriangleright]	

4

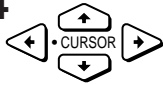

Press CURSOR \uparrow/\downarrow to move the cursor (\blacktriangleright) to AUTO PRESET, then press EXECUTE.



All receivable channels are preset in numerical sequence. When no more receivable channels can be found, presetting stops and the picture from the lowest numbered channel is displayed on the TV screen.

TUNER PRESET	PROG1
SYSTEM	\bullet B/G D/K
NORMAL / CATV	\bullet NORM CATV
\blacktriangleright AUTO PRESET	
CHANNEL SET	2 ON OFF
AFT	
FINE TUNING	
***** PLEASE WAIT *****	

continued

Manual setup — Presetting channels (continued)

Presetting channels manually

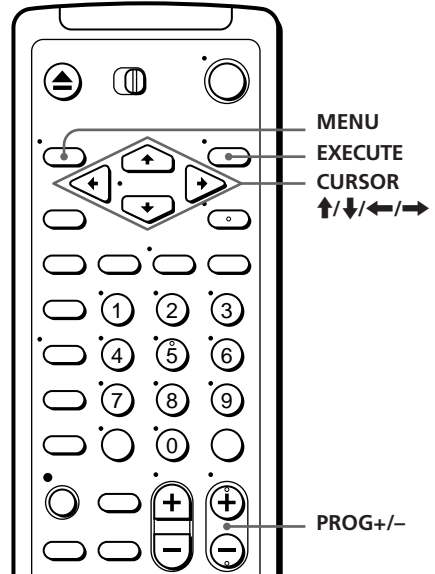

- 1**
- MENU
 - CURSOR
 - EXECUTE
- Press MENU, then press CURSOR \uparrow/\downarrow to move the cursor (\blacktriangleright) to TUNER PRESET and press EXECUTE.

TUNER PRESET	PROG10
SYSTEM	•B/G D/K
NORMAL / CATV	•NORM CATV
AUTO PRESET	
▶CHANNEL SET	3
AFT	•ON OFF
FINE TUNING	
SELECT : [$\blacktriangle\blacktriangleright$]	
SET : [$\blacktriangle\blacktriangleright$]	

- 2**
- CURSOR
- Press CURSOR $\uparrow/\downarrow/\leftarrow/\rightarrow$ to move the cursor (\blacktriangleright) to NORMAL/CATV, then select NORM.
- To preset CATV channels, select CATV.

TUNER PRESET	PROG10
SYSTEM	•B/G D/K
▶NORMAL / CATV	•NORM CATV
AUTO PRESET	
CHANNEL SET	3
AFT	•ON OFF
FINE TUNING	
SELECT : [$\blacktriangle\blacktriangleright$]	
SET : [$\blacktriangle\blacktriangleright$]	

- 3**
- CURSOR
- Press CURSOR \uparrow/\downarrow to move the cursor (\blacktriangleright) to CHANNEL SET.

TUNER PRESET	PROG10
SYSTEM	•B/G D/K
NORMAL / CATV	•NORM CATV
AUTO PRESET	
▶CHANNEL SET	3
AFT	•ON OFF
FINE TUNING	
SELECT : [$\blacktriangle\blacktriangleright$]	
SET : [$\blacktriangle\blacktriangleright$]	

4

• PROG



Press PROG +/- to select the programme position.

Selected programme position

TUNER PRESET	PROG14
SYSTEM	• B/G D/K
NORMAL / CATV	• NORM CATV
▶ CHANNEL SET	3
AFT FINE TUNING	• ON OFF
SELECT :	[▲▲]
SET :	[◆◆]

5

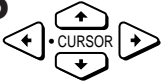

Press CURSOR → repeatedly until the channel you want is displayed. Pressing CURSOR ← goes back to the previous channels.

The channels are scanned in the following order:

TUNER PRESET	PROG14
SYSTEM	• B/G D/K
NORMAL / CATV	• NORM CATV
▶ CHANNEL SET	4
AFT FINE TUNING	• ON OFF
SELECT :	[▲▲]
SET :	[◆◆]

Channel coverage	System B/G	System D/K
VHF	NZ1-NZ11, E2-E12	R1-R12, C1-C12
UHF	E21-E69	R21-R60, C13-C56
CATV (TV distribution)	S1-S41, S01-S05	—

If you know the number of the channel you want, press the programme number buttons. For example, for channel 5, first press "0" and then press "5."

6

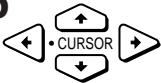

If the TV sound is distorted or noisy, press CURSOR ↑/↓/←/→ to move the cursor (▶) to SYSTEM, then select either B/G or D/K, whichever is applicable in your area.

TUNER PRESET	PROG14
▶ SYSTEM	• B/G D/K
NORMAL / CATV	• NORM CATV
AUTO PRESET	
CHANNEL SET	4
AFT FINE TUNING	• ON OFF
SELECT :	[▲▲]
SET :	[◆◆]

continued

Manual setup — Presetting channels (continued)

7

To allocate another channel to another programme position, repeat steps 4 and 5.

8

• EXECUTE



Press EXECUTE.

Disabling unwanted programme positions

After tuning the TV channels, you can disable unused programme positions. The disabled positions will be skipped later when you press the PROG +/- buttons.

You can also disable unwanted programme positions using the SET UP CH AND G-CODE menu (see page 24).

- 1 In step 5 above, press programme number button "0" twice to display the number "0" beside CHANNEL SET.
- 2 Press EXECUTE.

If the picture is not clear

Normally, the Auto Fine Tuning (AFT) function automatically tunes in channels clearly. If, however, the picture is not clear, you may also use the manual tuning function.

- 1 Press PROG +/- to select the programme number for which you cannot obtain a clear picture.
- 2 Press MENU, then select TUNER PRESET and press EXECUTE.
- 3 Select FINE TUNING. The fine tuning meter appears.

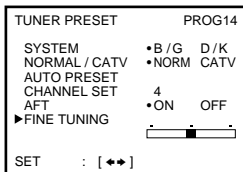

- 4 Press CURSOR ◀/▶ to get a clearer picture, then press EXECUTE.
Note that the AFT (Auto Fine Tuning) setting switches to OFF.

Note

- The menu disappears automatically if you don't proceed for more than a few minutes.

Manual setup — Setting up G-CODE



G-CODE is a feature in Sony VCRs that simplifies programming the VCR to make timer recordings. To use G-CODE, each programme position needs to be matched with its G-CODE guide channel. To get the guide channel numbers, look in the programme guide for your area that features G-CODE numbers.

- If you want to record satellite broadcasts using G-CODE, see page 21.

Before you start...

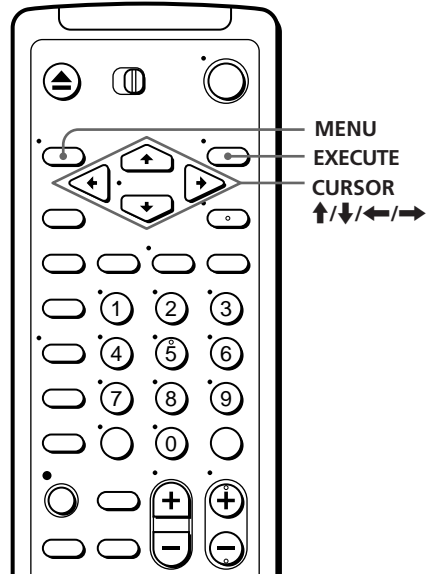
- Turn on the VCR and the TV.
- Set the TV to the video channel.



- 1**
- MENU

 - Press MENU, then press CURSOR ↑/↓ to move the cursor (▶) to SET UP CH AND G-CODE and press EXECUTE.
 - When using the EASY SET UP procedure, skip this step.
 - EXECUTE

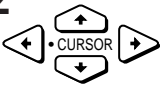
 - The preset channels are displayed on the screen.

SET UP CH AND G-CODE			
PROG	CH	GUIDE	CH
▶ 1	3	-	----
2	9	-	----
3	12	-	----
4	27	-	----
5	56	-	----
SELECT : [♦♦]			
MOVE PROG : [♦]			
ERASE PROG : [TIMER CLEAR]			

- 2**
- CURSOR

 - Press CURSOR ↑/↓ to move the cursor (▶) to the row on which you want to set the guide channel.
 - To display other pages for programme positions 6 to 50, press CURSOR ↑/↓ repeatedly.

SET UP CH AND G-CODE			
PROG	CH	GUIDE	CH
1	3	-	----
2	9	-	----
▶ 3	12	-	----
4	27	-	----
5	56	-	----
SELECT : [♦♦]			
MOVE PROG : [♦]			
ERASE PROG : [TIMER CLEAR]			

continued

Manual setup — Setting up G-CODE (continued)

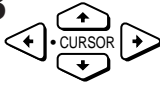
3



Press CURSOR → twice to select the guide channel column.

SET UP CH AND G-CODE			
PROG	CH	GUIDE	CH
1	3	-	---
2	9	-	---
▶ 3	12	-	[---]
4	27	-	---
5	56	-	---
SELECT GUIDE CH	:	[♦♦]	
CONFIRM	:	[♦♦]	

4

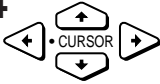

Press CURSOR ↑/↓ to select the guide channel number assigned in the programme guide.

SET UP CH AND G-CODE			
PROG	CH	GUIDE	CH
1	3	-	---
2	9	-	---
▶ 3	12	-	[-6]
4	27	-	---
5	56	-	---
SELECT GUIDE CH	:	[♦♦]	
CONFIRM	:	[♦♦]	

5

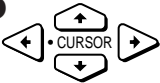

Press CURSOR ←/→ to confirm the setting.

SET UP CH AND G-CODE			
PROG	CH	GUIDE	CH
1	3	-	---
2	9	-	---
▶ 3	12	-	6
4	27	-	---
5	56	-	---
SELECT	:	[♦♦]	
MOVE PROG	:	[♦]	
ERASE PROG	:	[TIMER CLEAR]	

6

To set the guide channel of another station, repeat steps 2 to 5.

If you want to change the programme positions of the stations, proceed to step 2 of “Manual setup — Changing/disabling programme positions” on page 22.

7



Press EXECUTE.

Setting up G-CODE for satellite broadcasts

When your satellite tuner is connected via the AERIAL IN connector, first you have to set the programme position for each satellite channel using the TUNER PRESET menu. Then set the guide channel number for each satellite channel using the SET UP CH AND G-CODE menu.

If your satellite tuner is connected via the LINE-1 IN jacks, you don't have to set programme positions nor guide channel numbers for satellite channels. Skip the following operations.

- 1 Turn on the satellite tuner.
- 2 Press MENU, then select TUNER PRESET and press EXECUTE.
- 3 Press PROG +/- to select a programme position you want to use for watching a satellite channel.
- 4 Select CHANNEL SET, then press CURSOR → to tune the VCR to the satellite tuner.

The channel number displayed beside CHANNEL SET is used for receiving all satellite broadcasts from the satellite tuner.

TUNER PRESET		PROG6
SYSTEM	• B / G	D / K
NORMAL / CATV	• NORM	CATV
AUTO PRESET		
▶ CHANNEL SET	6	
AFT FINE TUNING	• ON	OFF
SELECT :	[▲▲]	
SET :	[◆◆]	

- 5 Press PROG +/- to select another programme position for another satellite channel, and press the programme number buttons to enter the same channel number as the one displayed in step 4.
Repeat this step for all satellite channels.
- 6 Set the guide channel number for each programme position assigned to the satellite channel, following the procedures in "Manual setup — Setting up G-CODE" on page 19.

Notes

- The menu disappears automatically if you don't proceed for more than a few minutes.
- If you inadvertently entered a guide channel number, press CURSOR ↑/↓ repeatedly to reset the "GUIDE CH" column to "----". "----" appears between 1 and 255.
- The VCR does not allow entering the guide channel number, if the same number has been set.
- If you use a satellite tuner connected via the LINE-1 IN jacks, you don't have to setup G-CODE. Just record a satellite programme using G-CODE, and the VCR automatically records the programme from the LINE-1 IN jacks.
- When you record a satellite broadcast using G-CODE, you need to select the desired channel on the satellite tuner manually.

Manual setup — Changing/ disabling programme positions

After setting the channels and G-CODE guide channels, you can change the programme positions as you like. If any programme positions are unused or contain unwanted channels, you can disable them.

Before you start...

- Turn on the VCR and the TV.
- Set the TV to the video channel.

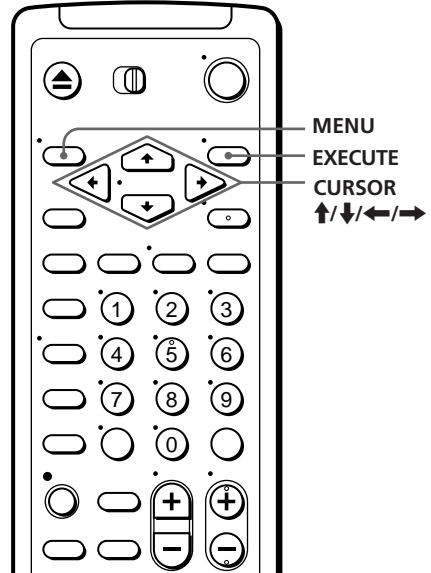

Changing programme positions

e.g. Moving the programme position from 4 to 1

1

• MENU

• EXECUTE

• CURSOR

Press MENU, then press CURSOR \uparrow/\downarrow to move the cursor (\blacktriangleright) to SET UP CH AND G-CODE and press EXECUTE.

When using the EASY SET UP procedure, skip this step.

SET UP CH AND G-CODE			
PROG	CH	GUIDE	CH
\blacktriangleright 1	3	--	16
2	9	--	2
3	12	--	6
4	27	--	12
5	56	--	---
SELECT	:	[\blacktriangle]	
MOVE PROG	:	[\blacktriangleright]	
ERASE PROG	:	[TIMER CLEAR]	

2

• CURSOR

Press CURSOR \uparrow/\downarrow to move the cursor (\blacktriangleright) to the row on which you want to change the programme position, then press CURSOR \rightarrow .

To display other pages for programme positions 6 to 50, press CURSOR \uparrow/\downarrow repeatedly.

SET UP CH AND G-CODE			
PROG	CH	GUIDE	CH
1	3	--	16
2	9	--	2
3	12	--	6
\blacktriangleright 4	[27]	--	12
5	56	--	---
SELECT	:	[\blacktriangle]	
SET GUIDE CH	:	[\blacktriangleright]	
CONFIRM	:	[\blacktriangle]	

3

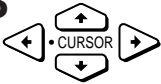

Press CURSOR \uparrow/\downarrow until the selected channel and guide channel row moves to the desired programme position.

The selected channel and guide channel are inserted at the new programme position and the intermediate channels are displaced to fill the gap.

SET UP CH AND G-CODE			
PROG	CH	GUIDE	CH
▶ 1	27	-	12
2	3	-	16
3	9	-	2
4	12	-	6
5	56	-	---
SELECT		:	[$\uparrow\downarrow$]
SET GUIDE CH		:	[\star]
CONFIRM		:	[\blacktriangleleft]

4

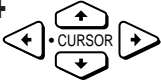

Press CURSOR \leftarrow to confirm the setting.

5

To change the programme position of another station, repeat steps 2 to 4.

6



Press EXECUTE.

continued

Manual setup — Changing/disabling programme positions (continued)

Disabling unwanted programme positions

Note

- Be sure to select the programme position you want to disable correctly. If you disable a programme position by mistake, you need to reset that channel manually.

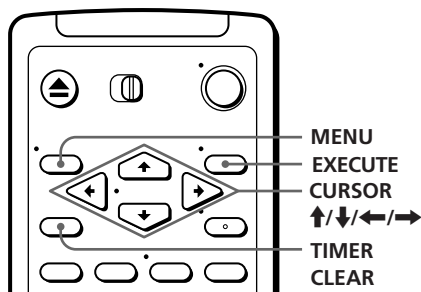

- 1**
- MENU
- Press MENU, then press CURSOR \uparrow/\downarrow to move the cursor (\blacktriangleright) to SET UP CH AND G-CODE and press EXECUTE.
- CURSOR
- When using the EASY SET UP procedure, skip this step.
- EXECUTE

SET UP CH AND G-CODE			
PROG	CH	GUIDE	CH
\blacktriangleright 1	3	-	16
2	9	-	2
3	12	-	6
4	27	-	12
5	56	-	---
SELECT	: [\blacktriangle \blacktriangleright]		
MOVE PROG	: [\blacktriangleright]		
ERASE PROG	: [TIMER CLEAR]		

- 2**
- CURSOR
- Press CURSOR \uparrow/\downarrow to move the cursor (\blacktriangleright) to the row on which you want to disable.

SET UP CH AND G-CODE			
PROG	CH	GUIDE	CH
1	3	-	16
2	9	-	2
\blacktriangleright 3	12	-	6
4	27	-	12
5	56	-	---
SELECT	: [\blacktriangle \blacktriangleright]		
MOVE PROG	: [\blacktriangleright]		
ERASE PROG	: [TIMER CLEAR]		

- 3**
- TIMER CLEAR
- Press TIMER CLEAR.
- The selected row will be cleared as shown on the right.

SET UP CH AND G-CODE			
PROG	CH	GUIDE	CH
1	3	-	16
2	9	-	2
\blacktriangleright 3	0	-	---
4	27	-	12
5	56	-	---
SELECT	: [\blacktriangle \blacktriangleright]		
MOVE PROG	: [\blacktriangleright]		
ERASE PROG	: [TIMER CLEAR]		

- 4**
- Repeat steps 2 and 3 for any other programme positions you want to disable.

- 5**
- EXECUTE
- Press EXECUTE.

Manual setup — Setting the clock

You must set the time and date on the VCR to be able to use the timer recording features properly. If you have not set the VCR clock in the EASY SET UP procedure, you need to set it manually.

Before you start...

- Turn on the VCR and the TV.
- Set the TV to the video channel.

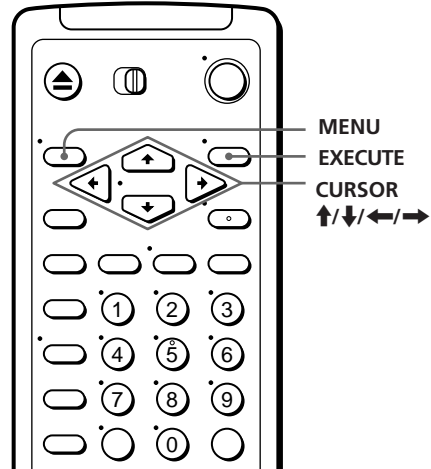

1

• MENU

• EXECUTE

• CURSOR

Press MENU, then press CURSOR \uparrow/\downarrow to move the cursor (\blacktriangleright) to CLOCK SET and press EXECUTE.

When using the EASY SET UP procedure, skip this step.

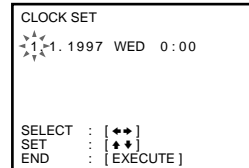

2

• CURSOR

Press CURSOR \uparrow/\downarrow to set the date.

The day of the week is set automatically.

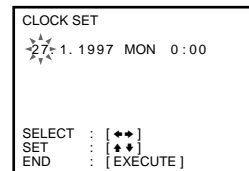

3

• CURSOR

Press CURSOR \rightarrow to select the month and set the month using CURSOR \uparrow/\downarrow .

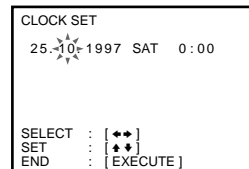

continued

Manual setup — Setting the clock (continued)

4

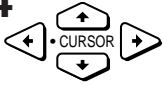

Set the year, hour and minutes in sequence, using CURSOR \rightarrow to select the item to be set, and CURSOR \uparrow/\downarrow to select the digits.

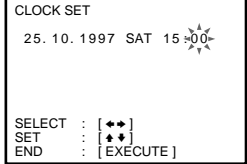

5

• EXECUTE



Press EXECUTE to start the clock.

Tip

- To change the digits during setting, press CURSOR \leftarrow to return to the item to be changed, and select the digits using CURSOR \uparrow/\downarrow .

Note

- The menu disappears automatically if you don't proceed for more than a few minutes.

Playing a tape

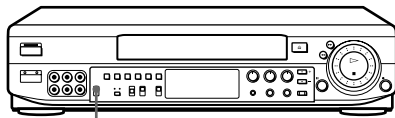

COLOR SYSTEM switch

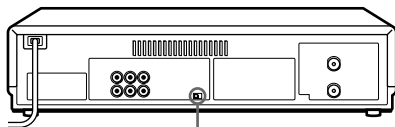

NTSC PB switch

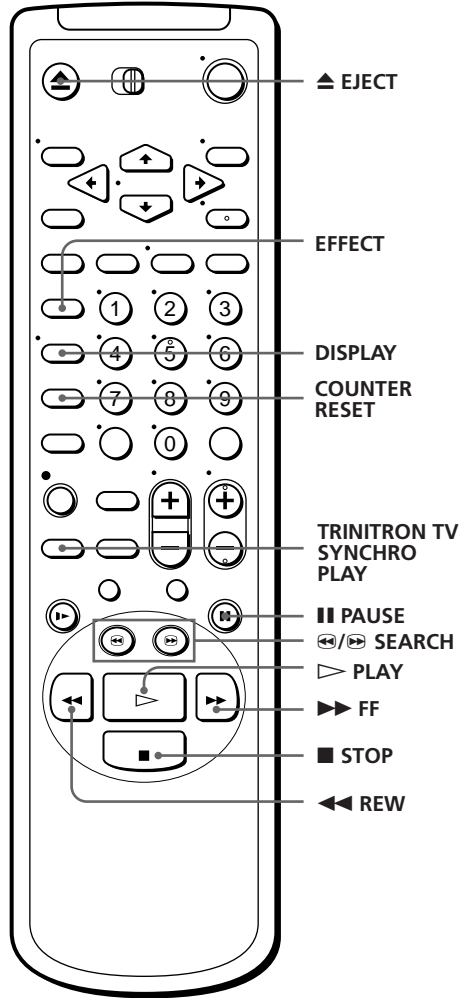

Basic Operations

1 Turn on your TV and set it to the video channel.

2 Insert a tape.
The VCR turns on and starts playing automatically if you insert a tape with its safety tab removed.

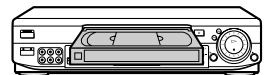

3 Press  PLAY.

When the tape reaches the end, it will rewind automatically.

continued

Playing a tape (continued)

Additional tasks

To	Press
Stop play	■ STOP
Pause play	PAUSE
Resume play after pause	PAUSE or ▷ PLAY
Search forward	▶▶ FF or 🔍 SEARCH during playback
Search backward	◀◀ REW or 🔍 SEARCH during playback
Fast-forward the tape	▶▶ FF during stop
Rewind the tape	◀◀ REW during stop
Eject the tape	▲ EJECT

To set the colour system

If streaks appear during playback, set COLOR SYSTEM on the VCR to conform to the system that the tape was recorded in. (When you select AUTO, normally, the colour system is correctly set whenever the tape is inserted.)

If your tape was recorded in	Set COLOR SYSTEM to
PAL	PAL/MESECAM
NTSC	NTSC
MESECAM	PAL/MESECAM

To play an NTSC-recorded tape

Set NTSC PB at the rear of the VCR according to the colour system of your TV.

If your TV is	Set NTSC PB to
PAL	ON PAL TV
NTSC 4.43	NTSC 4.43
NTSC 3.58	NTSC 3.58

To use the time counter

At the point on the tape that you want to find later, press COUNTER RESET. The counter in the display window resets to "0H00M00S." Search for the point afterwards by referring to the counter.

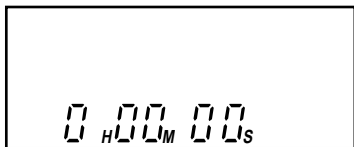

To display the counter on the TV screen, press DISPLAY.

Notes

- When you play back a tape recorded in the PAL or MESECAM colour system, streaks may appear even if the COLOR SYSTEM switch is set to PAL/MESECAM. If so, select the colour system, PAL or MESECAM in the PAL/MESECAM option of the SET UP MENU. (For details, see page 59.)
- The counter resets to "0H00M00S" whenever a tape is reinserted.
- The counter stops counting when it comes to a portion with no recording.
- If a tape has portions recorded in both PAL and NTSC systems, the time counter reading will not be correct. This is due to the difference between the counting cycles of the two video systems.
- Depending on your TV, the following may occur while playing an NTSC-recorded tape:
 - the picture is black and white,
 - the picture shakes,
 - no picture appears on the TV screen,
 - black streaks appear horizontally on the TV screen,
 - the colour density increases or decreases.

continued

Turning on the VCR and TV, and starting playback automatically (Trinitron TV Synchro Play)

You can only use this function if your TV is made by Sony (Trinitron TV).

How to connect to use this function

Connect the VCR and TV with the audio/video cable (see "To a TV that has phono type audio/video input jacks" on page 7.) Be sure to connect the audio/video cable to the VIDEO IN 1 jacks on the TV if the TV has two inputs or more. The TV must be placed where it will respond to the remote commander while you are pointing it at the VCR.

Operation

Make sure that the TV's power is in standby mode.

Press TRINITRON TV SYNCHRO PLAY and hold the remote commander in place for about two seconds.

The VCR and TV turn on, and the TV is set to the video channel. If there is a tape in the VCR, playback starts automatically.

Notes

- If the Trinitron TV Synchro Play function does not work properly:
 - Wait a few moments, and press the button again.
 - Replace both of the batteries with new ones, and press the button again.Note that this function may not operate some Sony TVs because of the remote commander's signal limitations.
- Do not press TRINITRON TV SYNCHRO PLAY while playing back a video tape. If you do so, the TV's input source will momentarily switch to the TV's tuner.

Recording TV programmes

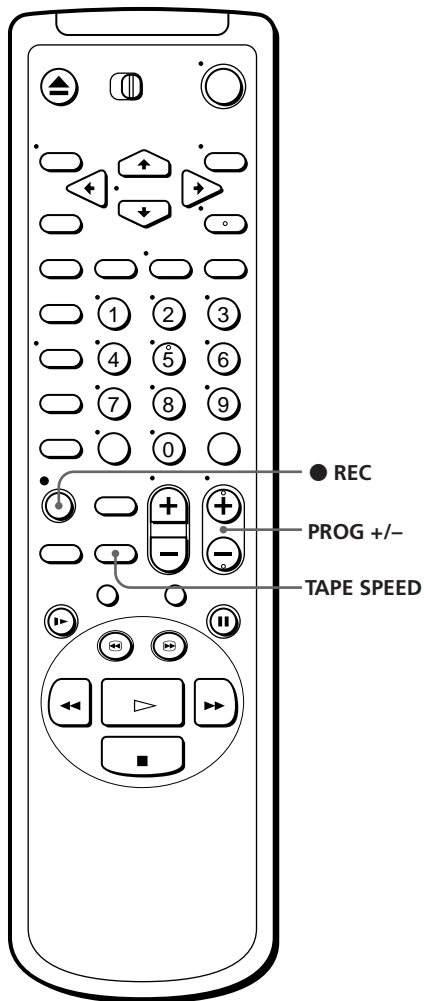

- 1** Turn on your TV and set it to the video channel.
- 2** Insert a tape with its safety tab in place.

continued

Recording TV programmes (continued)

3



Press PROG +/- to select the programme position you want to record.

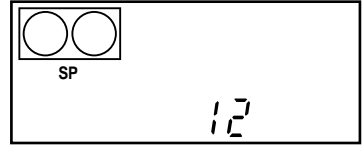

4



Press TAPE SPEED to select the tape speed, SP or LP.

LP provides recording time twice as long as SP, however, SP produces better picture and audio quality.

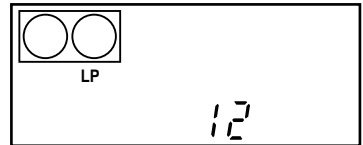

5



Press ● REC to start recording.

To stop recording

Press ■ STOP.

To check the remaining tape length (except for NTSC recorded tapes)

Press DISPLAY. The white bar indicates the approximate length of tape remaining.

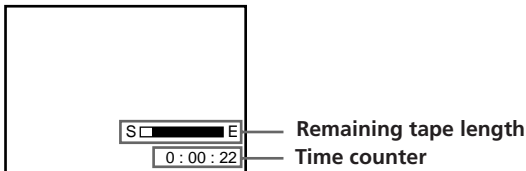

To watch another TV programme while recording

- 1 If the TV is connected to the VCR using an audio/video cable, set the TV to TV input. If the TV is connected to the VCR using only the aerial cable, skip this step.
- 2 Select another programme position on the TV.

To save a recording

To prevent accidental erasure, break off the safety tab as illustrated. To record on a tape again, cover the tab hole with adhesive tape.

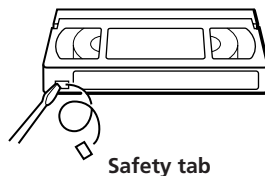

To record NTSC colour system programmes

NTSC colour signals can be recorded on this VCR.

For tape speed, select SP or EP in step 4.

EP provides recording time three times as long as SP, however, SP produces better picture quality.

When playing back, the VCR automatically detects the tape speed.

Tips

- To select a programme position, you can use the programme number buttons on the remote commander. For two-digit numbers, press the -- (ten's digit) button followed by the programme number buttons.
- You can select a video source from the LINE-1 IN or the LINE 2 IN jacks using the INPUT SELECT button.
- The display appears on the TV screen indicating information about the tape, but the information won't be recorded on the tape.
- If you don't want to watch TV while recording, you can turn off the TV.

Notes

- When you play back a tape recorded in the PAL or MESECAM colour system, streaks may appear even if the COLOR SYSTEM switch is set to PAL/MESECAM. If so, select the colour system PAL or MESECAM in the PAL/MESECAM option of the SET UP MENU. (For details, see page 59.)
- When the KARAOKE ON/OFF switch is set to ON, the VCR displays the karaoke information (page 50).

Recording TV programmes using G-CODE

Just enter the programme's G-CODE number listed in the TV programme guide. The date, times and programme position of that programme are set automatically. You can preset up to eight programmes at a time.

Before you start...

- Check that the VCR clock is set to the correct time.
- Insert a tape with its safety tab in place. Make sure the tape is longer than the total recording time.
- Turn on your TV and set it to the video channel.

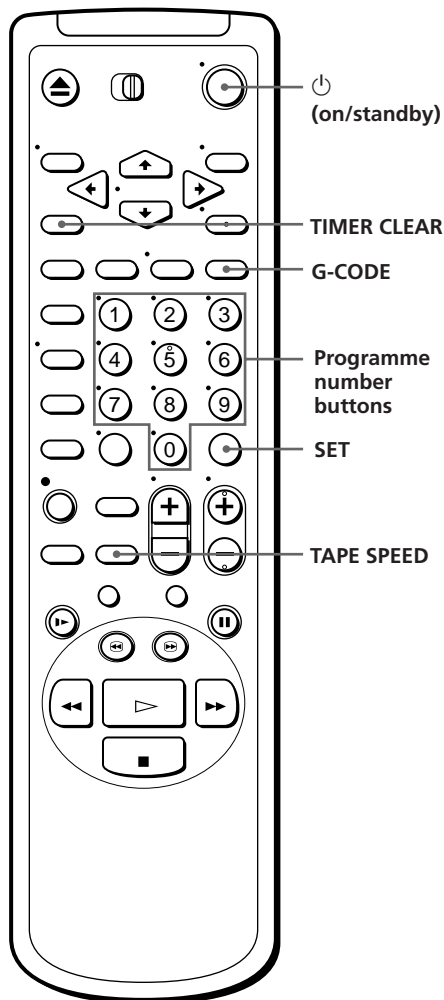

1 G-CODE  Press G-CODE.

G-CODE	
G-CODE No. [-----]	SP/LP [SP]
SET : [0-9]	
SP/LP : [TAPE SPEED]	

2

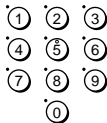

Press the programme number buttons to enter the programme's G-CODE number.

If you make a mistake, press TIMER CLEAR and re-enter the correct number.

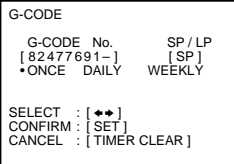

3



Press TAPE SPEED to select SP or LP.

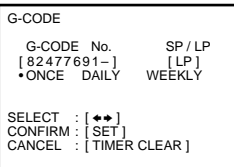

4

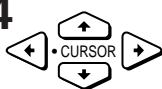

Select ONCE, DAILY or WEEKLY by using CURSOR ←/→, then press SET:

To record	Select
Only once	ONCE
Everyday Monday to Friday	DAILY
Once a week	WEEKLY

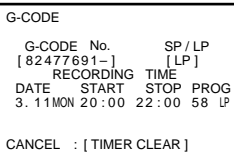

The date, start and stop times, programme position, and tape speed appear on the TV screen.

If the information is not correct, press TIMER CLEAR to cancel the setting.

5

To enter another setting, repeat steps 1 to 4.

6



Press to turn off the VCR.

The TIMER indicator appears in the display window and the VCR stands by for recording.

To stop recording

To stop the VCR while recording, press STOP.

continued

Recording TV programmes using G-CODE (continued)

To record satellite broadcasts

If you connect the satellite tuner and the VCR, you can record satellite programmes.

- 1** Turn on the satellite tuner.
- 2** On the satellite tuner, select the satellite programme for which you wish to make a timer setting.
- 3** Follow the steps on pages 34 and 35.
- 4** Keep the satellite tuner turned on until the VCR finishes recording the satellite programme for which you have made a timer setting.

To use the VCR after setting the timer

To use the VCR before a timer recording begins, just press \odot . The TIMER indicator turns off and the VCR switches on. Remember to press \odot to reset the VCR after using the VCR.

You can also do the following tasks while the VCR is recording:

- Reset the counter.
- Display tape information on the TV screen.
- Check the timer settings.
- Watch another TV programme.

Tips

- To cancel the procedure, press G-CODE before pressing SET.
- To record NTSC signals, set the tape speed to SP or EP. To set the EP mode, press TAPE SPEED to display "LP" in the tape speed position.

Note

- If the VCR beeps repeatedly, this means that:
 - The G-CODE number is incorrect.
 - ONCE, DAILY, or WEEKLY was selected incorrectly. You cannot select DAILY or WEEKLY for a programme that airs more than seven days ahead.

Setting the timer manually

The VCR automatically starts and stops recording TV programmes. You can preset up to eight programmes at a time.

Before you start...

- Check that the VCR clock is set to the correct time.
- Insert a tape with its safety tab in place. Make sure the tape is longer than the total recording time.
- Turn on your TV and set it to the video channel.

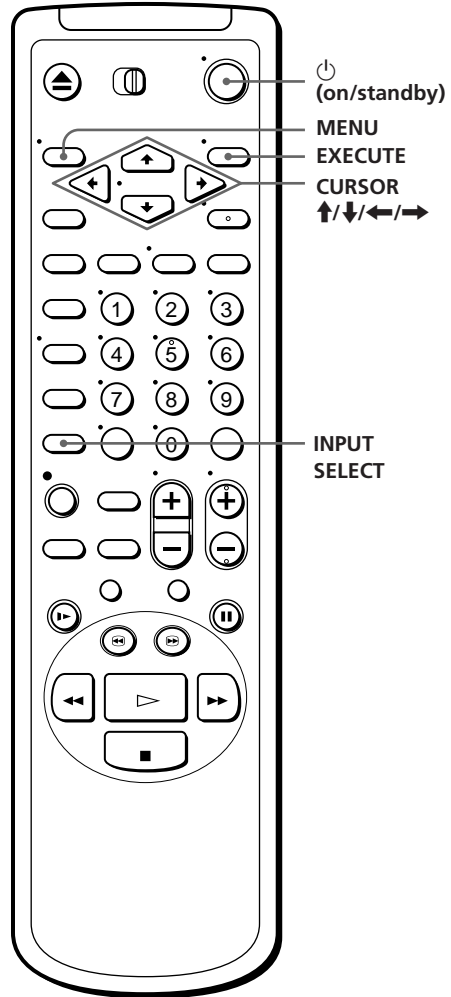

1

• MENU



Press MENU and select TIMER SET / CHECK, then press EXECUTE.

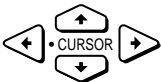

• EXECUTE



TIMER SET / CHECK	25.10	SAT	
DATE	START	STOP	PROG
▶---	---	---	---
---	---	---	---
---	---	---	---
---	---	---	---
---	---	---	---
---	---	---	---
---	---	---	---

continued

Setting the timer manually (continued)

2

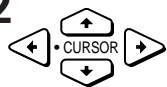

Set the date, start and stop times, programme position, and tape speed:

1 Press CURSOR → to select each item in turn.

2 Press CURSOR ↑/↓ to set each item.

To correct a setting, press CURSOR ← to return to that setting and reset.

To record the same programme every day or the same day every week, press CURSOR ↓ while the date is flashing. For details, see “Daily/weekly recording” below.

To record from a source connected to the LINE-1 IN or the LINE 2 IN jacks, press INPUT SELECT to display “L1” or “L2” in the “PROG” position.

TIMER SET / CHECK	DATE	START	STOP	PROG	SAT
▶	19 . 11 WED	- : -	- : -	-	SP
▶	2 2 1 2 1 1	- : -	- : -	-	-
-	- : -	- : -	- : -	-	-
-	- : -	- : -	- : -	-	-
-	- : -	- : -	- : -	-	-
-	- : -	- : -	- : -	-	-
-	- : -	- : -	- : -	-	-
-	- : -	- : -	- : -	-	-

3

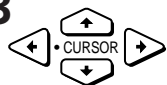

Press CURSOR → to confirm the setting.

To enter another setting, move the cursor to the next line and repeat step 2.

4



Press EXECUTE.

5



Press ⏻ to turn off the VCR.

The TIMER indicator appears in the display window and the VCR stands by for recording.

To record from other equipment, leave the connected equipment switched on.

To stop recording



To stop the VCR while recording, press ■ STOP.

Daily/weekly recording

In step 2 above, press CURSOR ↓ to select the recording pattern. Each time you press CURSOR ↓, the indication changes as shown below. Press CURSOR ↑ to change the indication in reverse order.

the current date → SUN-SAT → MON-SAT → MON-FRI → EVERY SAT
 → EVERY MON → EVERY SUN → 1 month later → (dates count down)
 → the current date

To use the VCR after setting the timer

To use the VCR before a timer recording begins, just press . The TIMER indicator turns off and the VCR switches on. Remember to press  to reset the VCR after using the VCR.

You can also do the following tasks while the VCR is recording:

- Reset the counter.
- Display tape information on the TV screen.
- Check the timer settings.
- Watch another TV programme.

Tips

- To set the programme position, you can also use the PROG +/- or programme number buttons.
- To set the tape speed, you can also use the TAPE SPEED button.
- To record NTSC signals, set the tape speed to SP or EP. To set the EP mode, display "LP" in the tape speed position.

Note

- "TIMER" flashes in the display window when you press  with no tape inserted.

Playing/searching at various speeds

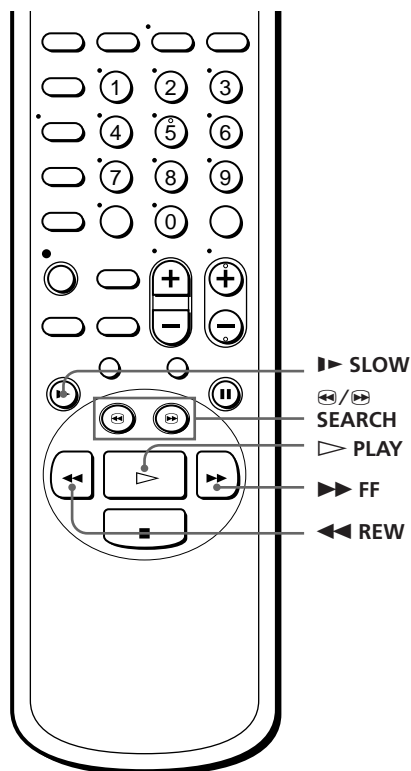

Playback options	Operation
Fast-forward/rewind	During stop, press ►► FF or ◀◀ REW.
View the picture during fast-forward or rewind	During fast-forward, hold ►► FF down. During rewind, hold ◀◀ REW down.
Play at high speed	During playback or pause, press ►► SEARCH or ◀◀ SEARCH. To change direction, press the other one.
Play in slow motion for two minutes	During playback or pause, press ► SLOW.
Rewind to the beginning of a tape and start play	During stop, hold ◀◀ REW down <u>on the VCR</u> , and press ▷ PLAY <u>on the VCR</u> .

To resume normal playback

Press ▷ PLAY.

Using the CLICK SHUTTLE ring

With the CLICK SHUTTLE ring on the VCR you can operate a variety of playback options.

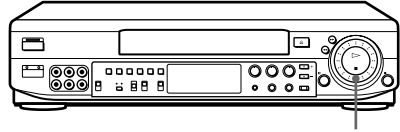

CLICK SHUTTLE ring

During playback or pause, turn the CLICK SHUTTLE ring clockwise or counterclockwise. Each change in the CLICK SHUTTLE ring position changes the playback mode, and the corresponding mark appears on the TV screen for a few seconds in the following way if the on-screen display function is on.

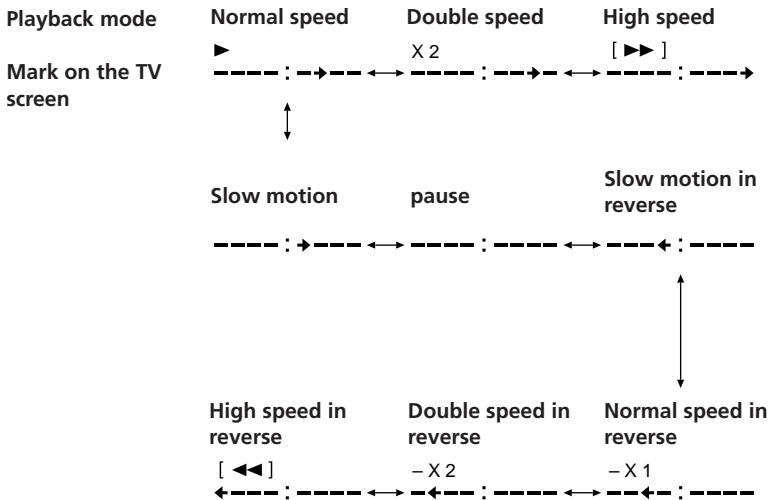

Tip

- Adjust the picture using TRACKING +/- on the VCR if:
 - streaks appear while playing in slow motion.
 - bands appear at the top or bottom while pausing.
 - the picture shakes while pausing.

Notes

- The playback sound is muted during these operations.
- In the LP mode, noise may appear or there may be no colour.
- If the playback mode mark doesn't appear on the TV screen, press DISPLAY.
- The playback mode mark may shake while playing or searching at various speeds.

Recording TV programmes using the quick timer

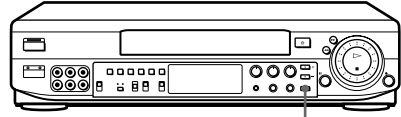

QUICK TIMER

After starting recording in the normal way, you can have the VCR stop recording automatically after a specified duration.

- 1 While recording, press QUICK TIMER on the VCR once.



- 2 Press QUICK TIMER repeatedly to set the duration.
Each press advances the time in increments of 30 minutes.

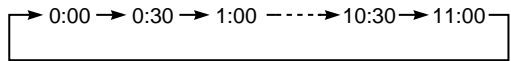

The duration decreases minute by minute to 0:00, then the VCR stops recording and turns off automatically.

To extend the duration

Press QUICK TIMER repeatedly to set to the new duration.

To stop recording

To stop the VCR while recording, press ■ STOP.

Tip

- You can also set the quick timer and start recording during the stop mode.

Checking/ changing/ cancelling timer settings

Before you start...

- Turn on your TV and set it to the video channel.

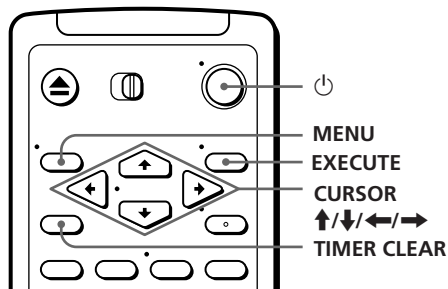

- 1 Press to turn on the VCR.
- 2 Press MENU, then select TIMER SET/CHECK:

- If you want to change a setting, go on to the next step.
- If you do not need to change the settings, press EXECUTE, then turn off the VCR to return to recording standby.

TIMER SET / CHECK	25.10	SAT	
DATE	START	STOP	PROG
▶ 2.11 SUN	7:00	8:00	6 SP
4.11 TUE	21:00	0:00	50 LP
MON-SAT	12:12	13:00	27 LP
EVERY SUN	23:00	0:00	L1 SP
---	---	---	---
---	---	---	---
---	---	---	---

- 3 Press CURSOR to select the setting you want to change or cancel:
 - To change the setting, press CURSOR to select the item you want to change, and press CURSOR to reset it. Then, press CURSOR repeatedly until the cursor (▶) appears at the beginning of the line.
 - To cancel the setting, press TIMER CLEAR.
- 4 Press EXECUTE.

If any settings remain, turn off the VCR to return to recording standby.

When the timer settings overlap

The programme that starts first has priority and the second programme starts recording only after the first programme has finished. If the programmes start at the same time, the programme listed first in the menu has priority.

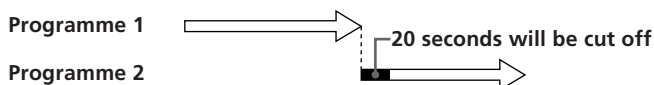
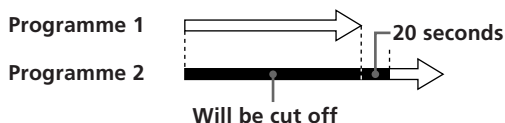

Recording stereo and bilingual programmes

In ZWEITON (German stereo) system

This VCR automatically receives and records stereo and bilingual programmes based on the ZWEITON system. When a stereo or bilingual programme is received, the STEREO indicator appears in the display window.

To select bilingual sound while recording

Press AUDIO MONITOR to select the sound you want.

To listen to	On-screen display	Display window
Main	MAIN	L
Sub	SUB	R
Main and sub	MAIN/SUB	L, R STEREO

Selecting the sound during playback

Press AUDIO MONITOR to select the sound you want.

Stereo programme

To listen to	On-screen display	Display window
Stereo	STEREO	L, R STEREO
Left channel	LCH	L
Right channel	RCH	R
Standard sound*	No indicator	No indicator

* Usually the mixed sound of the left and right channels

Bilingual programme

To listen to	On-screen display	Display window
Main	MAIN	L
Sub	SUB	R
Main and sub	MAIN/SUB	L, R STEREO
Standard sound*	No indicator	No indicator

* Usually the main sound (monaural)

To check audio channel and sound level

You can check the audio channel and sound level visually with the indicators in the display window.

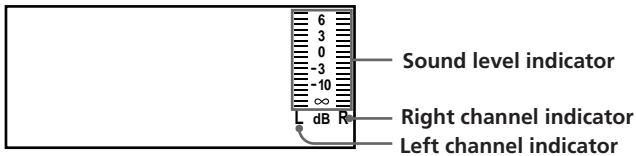

How sound is recorded on a video tape

The VCR records sound onto two separate tracks. Hi-fi audio is recorded onto the main track along with the picture. Monaural sound is recorded onto the normal audio track along the edge of the tape.

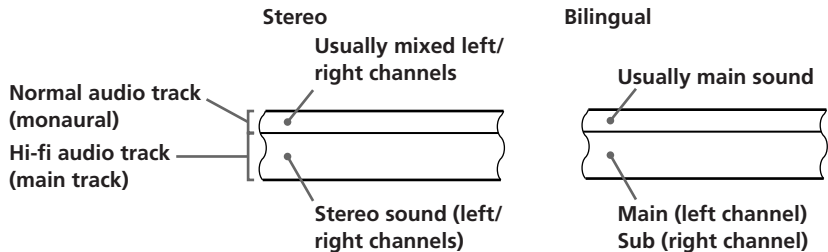

Notes

- To play a tape in stereo, you must use the AUDIO OUT connections.
- When you play a tape recorded in monaural, the sound is heard in monaural regardless of the AUDIO MONITOR setting.
- If the AUDIO MONITOR button does not function, check that AUDIO MIX in the SET UP MENU is set to OFF.

Karaoke sing-along

You can sing along with a karaoke videotape, a TV broadcast, or music played back on equipment connected to the LINE IN jacks on the VCR. You can sing duets if you use an extra microphone (not supplied).

Singing along with karaoke video tapes

Before you start...

- Turn on the VCR and the TV.
- Set the TV to the video channel.
- Connect the supplied microphone to the MIC IN 1 jack and its control plug to the CONTROL jack. To sing duets, connect an optional microphone to the MIC IN 2 jack.

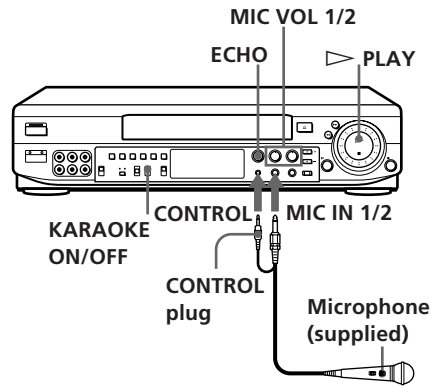

- 1** Set KARAOKE ON/OFF to ON.

“KARAOKE MODE WELCOME TO THE Sony KARAOKE WORLD” appears on the TV screen.

- 2** Insert a karaoke video tape.

The VCR starts playing automatically if you insert a tape with its safety tab removed.

- 3** Press ▷ PLAY.

If you want to playback a specific song, see “Searching with the AMS or index function” on page 55.

- 4** Switch the microphone on.

Now you can enjoy singing karaoke.

To adjust the microphone volume

Turn the MIC VOL 1 control for the microphone connected to MIC IN 1.
Turn the MIC VOL 2 control for the microphone connected to MIC IN 2.

Setting the MIC VOL 1 and/or 2 control(s) to the centre position provides the best microphone volume.

To control the echo effect

Turn the ECHO control. This adjusts both microphones’ echo effect to the same level. To get the best effect, adjust the microphone volume to a slightly higher level than the music volume.

Tip

- When you sing along with TV broadcasts or music played back on equipment connected to the LINE IN jacks on the VCR, play the music source and follow steps 1 and 4.

Notes

- If the sound is reproduced through a stereo amplifier, turn down the volume of amplifier before operation.
- If streaks appear during playback, select the colour system that the tape was recorded in (see "To set the colour system" on page 28).
- If feedback occurs, turn down the microphone or TV volume, or move the microphone away from the speakers.

Using the supplied microphone

You can control some of the VCR's karaoke functions with the microphone.

- 1** CHOI button
Press and hold to rewind the tape while viewing the picture.
- 2** **b/#** buttons
Change the pitch in Key Control mode (page 50).
Set the harmony interval in Self Duet mode (page 51).
- 3** KEY/S.D./OFF selector
Select KEY or S.D. to switch the microphone on in the Key Control mode or the Self Duet mode. Select OFF to switch the microphone off.

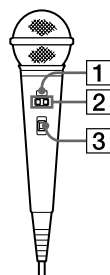

Note

- The **b/#** buttons and KEY/S.D. button on the microphone may not operate with other VCRs.

continued

Karaoke sing-along (continued)

Playing a tape in a programmed order (Karaoke Program)

You can sing songs in the order you want.

Before you start...

- Turn on your TV and set it to the video channel.
- Select the search mode, AMS or INDEX in the SET UP KARAOKE menu. For details, see "Selecting the AMS or index function" on page 55.

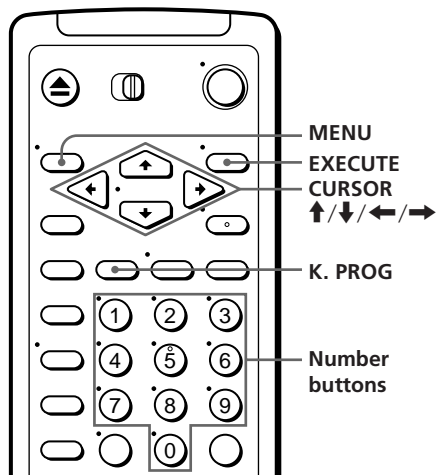

1 Insert a tape and set KARAOKE ON/OFF on the VCR to ON.

2 Press K. PROG.

3 Press the number buttons to select up to ten songs in the order you want.

For single-digit numbers, first press "0" then the song number. To correct a song number, press CURSOR ← to return to that number and reset it.

4 Press EXECUTE.

The tape automatically rewinds to the beginning, and playback starts in the order you selected. While the VCR searches for a song, the song number flashes in the display window.

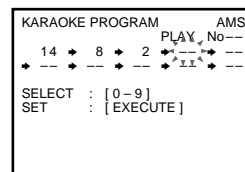
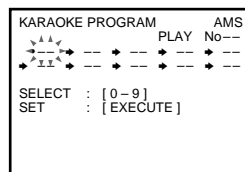

To stop playing

Press ■ STOP.

To change the programme order

Press ■ STOP and repeat steps 2 through 4 above.

Tip

- You can also select the KARAOKE PROGRAM menu by pressing MENU and CURSOR ↑/↓.

Notes

- If you set KARAOKE ON/OFF to OFF, the list settings are cleared.
- When you turn off the VCR, the VCR exits the KARAOKE PROGRAM mode.
- When you press ◀◀/▶▶ SEARCH AMS/INDEX while in Karaoke Program mode, the VCR does not search beyond the current song, but rewinds the tape to the beginning of the song being played back, or fast-forwards to the next song. When the VCR exits KARAOKE PROGRAM mode, ◀◀/▶▶ SEARCH AMS/INDEX returns to its normal function. (See “Searching with the AMS or index function” on page 55.)
- If you press CHOI on the microphone and rewind past the beginning of the current song, the selected song order may not be played correctly.

Displaying the karaoke information

Press DISPLAY when the KARAOKE ON/OFF switch is set to ON. The karaoke information appears on the TV screen. If you press DISPLAY once more, the remaining tape length and time counter will also appear.

To turn off the display, press DISPLAY again.

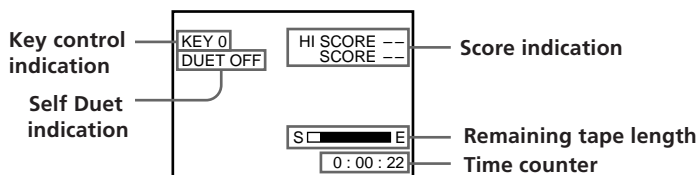

continued

Karaoke sing-along (continued)

Changing the pitch (Key Control)

While you are singing, you can change the pitch of the song to match your vocal range.

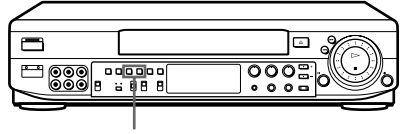

KEY CONTROL ♭/#

Press KEY CONTROL ♭ or # repeatedly to set the pitch you want.

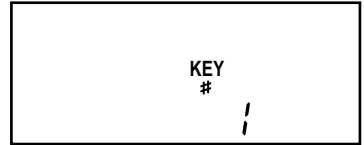

You can change the pitch of the song in half tone intervals.

To	Press	Range	Display window
Raise the pitch	# (sharp)	8 half tones	"#1" to "#8"
Lower the pitch	♭ (flat)	8 half tones	"♭1" to "♭8"

To return to the original pitch

Press KEY CONTROL ♭ or # repeatedly until "0" appears in the display window.

Tip

- You can also change the pitch with the supplied microphone.

Adding harmony (Self Duet)

You can sing duets by yourself.
The VCR creates a harmony voice
at the interval you want.

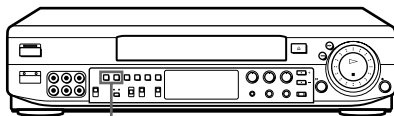

SELF DUET \flat/\sharp

Press SELF DUET \flat/\sharp to select a high or low harmony voice.

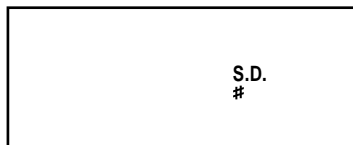

To	Press	Display window
Add a high harmony	\sharp (sharp)	"S.D. \sharp "
Add a low harmony	\flat (flat)	"S.D. \flat "

To cancel the Self Duet

Press SELF DUET \flat/\sharp again.

Tip

- You can also change the pitch with the supplied microphone.

continued

Karaoke sing-along (continued)

Reducing the playback vocals (Karaoke Pon)

This function reduces the vocals on played back music sources. You can use hi-fi stereo music sources for karaoke.

Set KARAOKE MODE to KARAOKE PON.

The singer's voice is reduced.

To cancel Karaoke Pon

Set KARAOKE MODE to OFF.

Note

- Karaoke Pon does not work with the following tapes:
 - Tapes on which different vocal sounds are recorded on the left and right channels, such as a duet
 - Monaural recorded tapes
 - Tapes on which sound sources are recorded with strong echo effects and/or chorus-effects

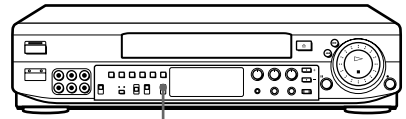

KARAOKE MODE

Backing up your singing (Vocal Assist)

This VCR can assist your singing in case you forget the lyrics while you are singing. The VCR fills in the vocal for you automatically if you stop singing into the microphone. Use karaoke stereo hi-fi tapes which have the accompaniment music on the left channel and the accompaniment plus vocal on the right channel.

Set KARAOKE MODE to VOCAL ASSIST.

To cancel Vocal Assist

Set KARAOKE MODE to OFF.

Note

- Vocal Assist does not work with the following tapes:
 - Hi-fi tapes on which the same sound is recorded on the left and right channels
 - Monaural recorded tapes

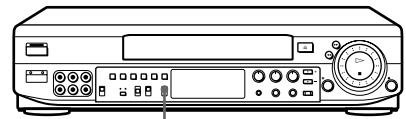

KARAOKE MODE

Grading your singing

As an extra challenge, the VCR can grade your singing.

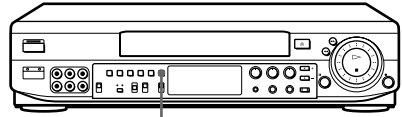

SCORE

1 Start singing and press SCORE.
“SCORE” appears on the TV screen, and the VCR starts analysing your singing.

2 Press SCORE again after singing for more than one minute.

Your score appears on the TV screen for five seconds. The highest score (HI SCORE) is saved, and is indicated above your present score.

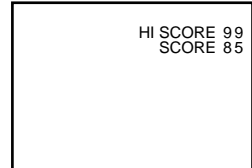

To score automatically (Auto Score)

The VCR automatically scores each song in order during Karaoke Program. Press MENU and select SET UP KARAOKE, then set AUTO SCORE to ON.

Each time a song ends, the score appears for five seconds.

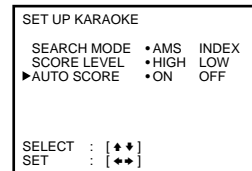

To set the score level

This VCR has two different score levels. To set the score level, press MENU and select SET UP KARAOKE. Then set SCORE LEVEL to HIGH for easy grading or LOW for strict grading.

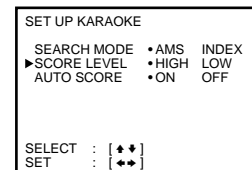

Tips

- The highest possible score is 99 points.
- To display your score on the TV screen again, press DISPLAY.
- The highest score is cleared each time you set the KARAOKE ON/OFF switch to OFF.

Note

- The grading is not absolute. Please use this function for your own amusement.

continued

Karaoke sing-along (continued)

Competing for the loudest voice

The VCR measures and displays the loudness of the voice numerically when you shout into the microphone.

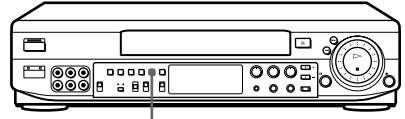

SHOUT

1 Press SHOUT.

“SHOUT” appears in the display window (English on-screen display only) and the VCR starts a countdown on the TV screen.

2 Shout into the microphone when the VCR counts down to 0.

While you are shouting, the highest score (MAX LEVEL) and your current shout level are displayed on the TV screen with a level meter. Below the level meter, a bar appears every second to show the changes in your shout level.

After five seconds, the measurement is complete and the highest score (MAX LEVEL) and your score (YOUR LEVEL) appear.

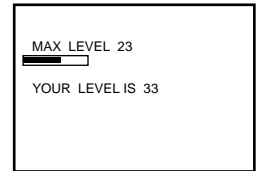

Tips

- To exit SHOUT mode, press SHOUT again.
- The highest score (MAX LEVEL) is cleared each time you set the KARAOKE ON/OFF switch to OFF.

Note

- Adjust the MIC VOL control to the centre position and turn down the TV volume.

Searching with the AMS or index function

You can search for the start of a specific passage or scene. There are two ways for automatic searching depending on the way the tape was recorded.

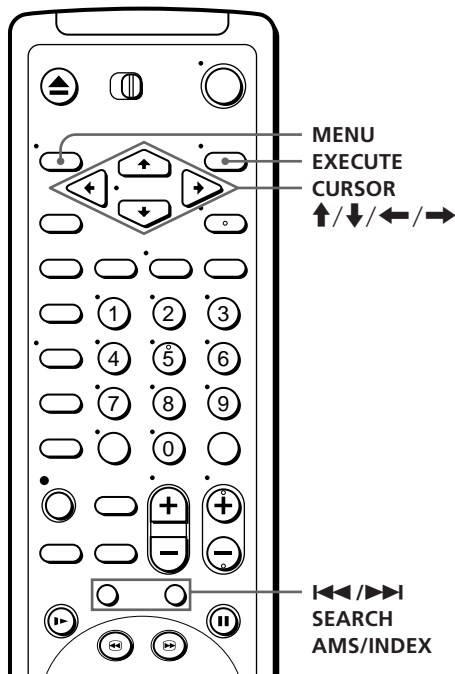

Selecting the AMS or index function

The AMS (Automatic Music Sensor) function is mainly for karaoke tapes. It searches for blank spaces (of at least four seconds) between recorded signals on the sound track of a tape. Use this function to search an index-incompatible tape. If you are not sure of the way the tape was recorded, try AMS first.

The index function is for indexed tapes like the tapes recorded with this VCR. The VCR marks the tape with an index signal at the point where each recording begins. When you use commercially prerecorded tape, check the packaging to see if the tape is index-compatible.

- 1 Press MENU and select SET UP KARAOKE, then press EXECUTE.
- 2 Press CURSOR $\uparrow/\downarrow/\leftarrow/\rightarrow$ to select SEARCH MODE, then select either AMS or INDEX.
- 3 Press EXECUTE.

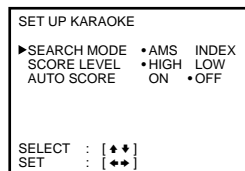

continued

Searching with the AMS or index function (continued)

Searching with the AMS function

The VCR can search up to 99 blank spaces ahead of or behind the current position.

- 1 Set KARAOKE ON/OFF on the VCR to ON.
- 2 Insert a tape into the VCR.
- 3 Press **◀◀ / ▶▶** SEARCH AMS/INDEX repeatedly to specify how many blank spaces ahead or behind you want to search:
 - To search ahead, press **▶▶** SEARCH AMS/INDEX.
 - To search backwards, press **◀◀** SEARCH AMS/INDEX.

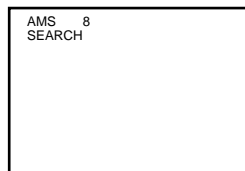

The VCR starts searching and the number of blank spaces on the TV screen counts down to zero. Playback starts automatically from that point.

To stop searching

Press **■** STOP.

Searching with the index function

The VCR can search up to 99 index signals ahead of or behind the current position.

- 1 Insert an indexed tape into the VCR.
- 2 Press **◀◀ / ▶▶** SEARCH AMS/INDEX repeatedly to specify how many index signals ahead or behind you want to search:
 - To search ahead, press **▶▶** SEARCH AMS/INDEX.
 - To search backwards, press **◀◀** SEARCH AMS/INDEX.

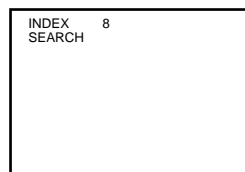

The VCR starts searching and the index number on the TV screen counts down to zero. Playback starts automatically from that point.

To stop searching

Press **■** STOP.

Notes

- No index signal will be added when recording starts from recording pause. However, an index signal will be marked if you change the channel during recording pause.
- The AMS function only works when the KARAOKE ON/OFF switch is set to ON.
- You cannot use the AMS function on tapes that have many blank spaces in a short time span such as dramas and dialogues.

Enjoying the surround sound (Virtual Sound)

You can use the Virtual Sound function to give stereo sources the surround sound effect and monaural sources a simulated stereo effect.

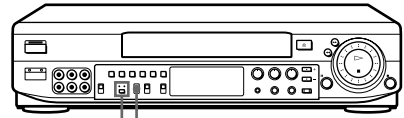

- 1 Select the type of sound source with the VIRTUAL SOUND switch. Select SURROUND when listening to a stereo source; select SIMULATED STEREO for a monaural source.
- 2 Press EFFECT so the WIDE or WARP indicator lights up.

Virtual sound

Type	Effect	For
SURROUND (stereo)	WIDE	A sound effect that spreads out over a large area
	WARP	A sound effect that totally envelopes you in sound
SIMULATED STEREO (monaural)	WIDE	A simulated stereo effect
	WARP	A wide ranging simulated stereo effect

To cancel the Virtual Sound

Press EFFECT repeatedly until both WIDE/WARP indicators turn off.

Notes

- This function is available only when the tape sound is reproduced on a stereo TV (or other stereo audio equipment). If the connected TV or other audio equipment is monaural or simulated stereo, you cannot get a clear effect.
- We recommend that you do not use the surround effect function of this VCR and that of the connected TV (or other audio equipment) at the same time. If you do so, the function may not work properly because the effects overlap each other.

Adjusting the picture

Adjusting the tracking

Although the VCR automatically adjusts the tracking when playing a tape (the tracking indicator  flashes in the display window, then goes off), distortion may occur if the tape was recorded in poor condition. If so, manually adjust the tracking.

Press TRACKING +/- on the VCR to display the tracking meter. The distortion should disappear as you press one of the two buttons (The  indicator lights up). To resume automatic tracking adjustment, eject the tape and reinsert it.

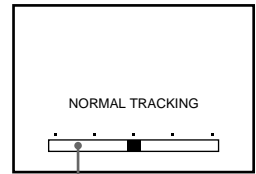

Tracking meter

About Adaptive Picture Control (APC)

Adaptive Picture Control (APC) automatically improves recording and playback quality by adjusting the VCR to the condition of the video heads and tape. To maintain better picture quality, we recommend that you set APC to ON in the SET UP MENU (with the APC indicator in the display window lit).

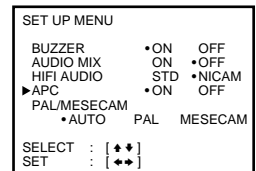

APC playback

The APC function automatically works on all types of tapes, including rental tapes and tapes that were not recorded with APC.



APC recording

Whenever you insert a tape and start recording for the first time, the VCR adjusts to the tape using the APC function (the APC indicator flashes rapidly). This adjustment is retained until the tape is ejected.

To deactivate the APC

Press MENU and select SET UP MENU, then set APC to OFF. The APC indicator in the display window goes off.

Note

- There is a delay of a few seconds before the VCR actually starts recording while the VCR analyses the tape. To avoid the delay, first set the VCR to recording pause (the APC indicator flashes slowly) and press  REC to have the VCR analyse the tape (the APC indicator flashes rapidly). After the APC indicator stops flashing, press  PAUSE to start recording immediately. If you want to start recording quickly without using the APC function, first set the VCR to recording pause (the APC indicator flashes slowly) and press  PAUSE to start recording.

Changing menu options

1 Press MENU, then select SET UP MENU.

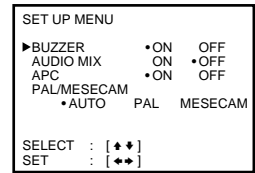

2 Press CURSOR **↑/↓** to select the option to change, then press CURSOR **←/→** to change the setting.

3 Press EXECUTE to return to the original screen.

Menu choices

Initial settings are indicated in bold print.

Menu option	Set this option to
BUZZER	<ul style="list-style-type: none"> • ON to output a beep sound when all illogical operation is made. • OFF to deactivate it.
AUDIO MIX	<ul style="list-style-type: none"> • ON to listen to the hi-fi and normal audio tracks at the same time. The AUDIO MONITOR button will not function. • OFF to listen to hi-fi and normal audio tracks separately. Select the sound using the AUDIO MONITOR button. <p>For details, see page 62.</p>
APC	<ul style="list-style-type: none"> • ON to switch on the APC (Adaptive Picture Control) function and improve picture quality. • OFF to switch off APC. <p>For details, see page 58.</p>
PAL/MESECAM	<ul style="list-style-type: none"> • AUTO to record/play back in the colour system selected automatically. Normally, select AUTO. • PAL to record/play back in the PAL colour system. • MESECAM to record/play back in the MESECAM colour system. <p>For details, see page 29.</p>

Connecting to a VCR or stereo system

How to connect to record on this VCR

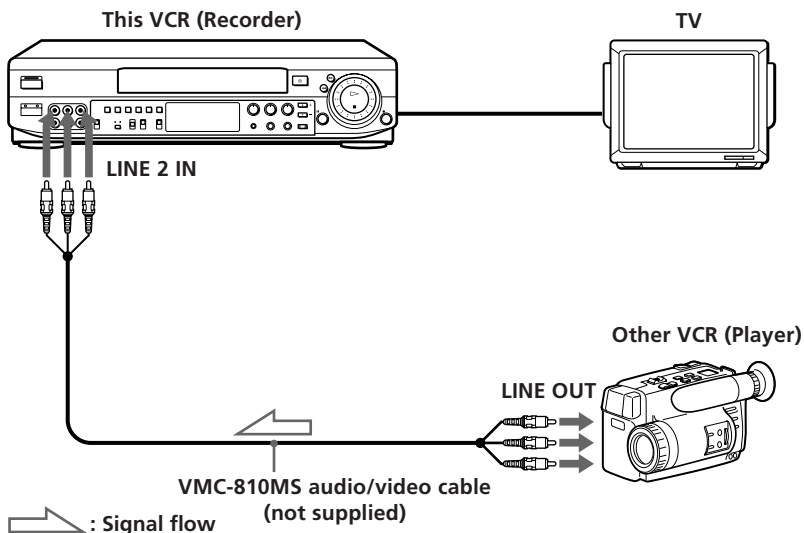

Tip

- You can also use the LINE-1 IN jacks instead.

Notes

- Make sure you connect the plugs to jacks of the same colour.
- If the other VCR is a monaural type, connect the audio plug to the AUDIO L (white) jack. The sound is recorded on both right and left channels. When connecting to the AUDIO R (red) jack, the sound is recorded only on the right channel.
- If you connected this VCR to both the LINE IN and LINE OUT jacks of the other VCR, select the input correctly to prevent a humming noise.

How to connect to a stereo system

Connect LINE 2 IN AUDIO on this VCR to the audio output jacks on the stereo system, using the RK-C510KS audio cable (not supplied).

Basic editing

(when recording on this VCR)

Before you start editing

- Turn on your TV and set it to the video channel.
- Press INPUT SELECT on the remote commander to display "L2" (or "L1") in the display window.
- Press TAPE SPEED on the remote commander to select the tape speed (SP or LP for the PAL system, and SP or EP for the NTSC system).

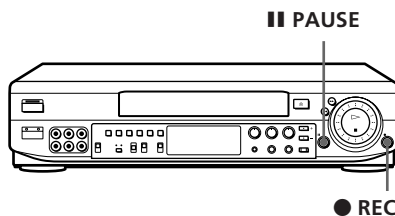

- 1** Insert a source tape with its safety tab removed into the other (playback) VCR. Search for the point to start playback and set it to playback pause.
- 2** Insert a tape with its safety tab in place into this (recording) VCR. Search for the point to start recording and press **II PAUSE**.
- 3** Press **● REC** on this VCR and set it to recording pause.
- 4** To start editing, press the **II PAUSE** buttons on both VCRs at the same time.

To stop editing

Press the **■ STOP** buttons on both VCRs.

Tips

- To edit more precisely, press the **II PAUSE** buttons on the VCRs to release pause.
- To cut out unwanted scenes while editing, press **II PAUSE** on this VCR when an unwanted scene begins. When it ends, press **II PAUSE** again to resume recording (Assemble Editing).
- You can dub sound onto the normal audio track through a microphone while editing. Set KARAOKE ON/OFF to ON before you start dubbing.

Note

- If you start recording following the procedure above, the VCR won't start recording with the APC function. To record a tape with the APC function, press **● REC** again during recording pause in step 3 so that the VCR analyses the tape. Then when you start recording in step 4, press **II PAUSE** after the APC indicator stops flashing. If you press **II PAUSE** before the APC indicator stops flashing, the APC function is cancelled.

Audio dubbing

This feature lets you record over the normal audio track. The monaural sound previously recorded is replaced while the original hi-fi sound remains unchanged. Use this feature to add commentary to a tape that you have recorded with a camcorder. You can also record your karaoke performances.

Audio dubbing from a stereo system or other external source

Before you start dubbing

- Turn on your TV and set it to the video channel.
- Press INPUT SELECT to display “L2” in the display window.

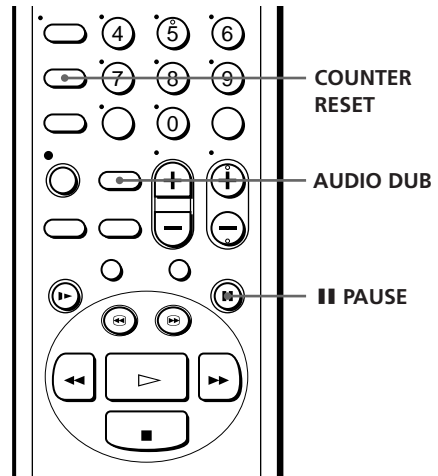

- 1** Insert a source tape into the stereo system (or the playback VCR). Search for the point to start playback and set it to playback pause.
- 2** Insert a prerecorded tape into this (recording) VCR. Search for the end of the section to be replaced and press **|| PAUSE**.
Make sure that the tape has its safety tab in place.
- 3** Press COUNTER RESET on this VCR to reset the counter to “0H00M00S.”
- 4** Rewind the prerecorded tape to the beginning of the section to be replaced.
The VCR pauses.
- 5** Press AUDIO DUB.
The audio dubbing indicator \ominus appears in the display window.
- 6** To start editing, press the **|| PAUSE** buttons on this VCR and the stereo system (or other VCR) at the same time.
When the counter reaches “0H00M00S,” audio dubbing stops automatically.

To stop while recording

Press the **■ STOP** buttons on this VCR and the stereo system (or other VCR).

To listen to both the hi-fi and normal audio

Set AUDIO MIX to ON in the SET UP MENU (page 59). Use this feature to listen to dubbed audio over the original hi-fi audio. When AUDIO MIX is set to ON, the AUDIO MONITOR button does not function. Remember to reset AUDIO MIX to OFF after playing the tape.

To listen to the dubbed sound (normal audio)

Press AUDIO MONITOR until the “L,” “R,” and “STEREO” indicators go off in the display window.

Audio dubbing from the microphone

Using the microphone, you can add songs or narration on a recorded tape. Sound from the microphone is mixed with the original hi-fi sound and recorded on the normal audio track.

Before you start dubbing

- Connect the microphone(s) to the MIC IN 1 and/or 2 jack(s), and turn on the microphone(s).

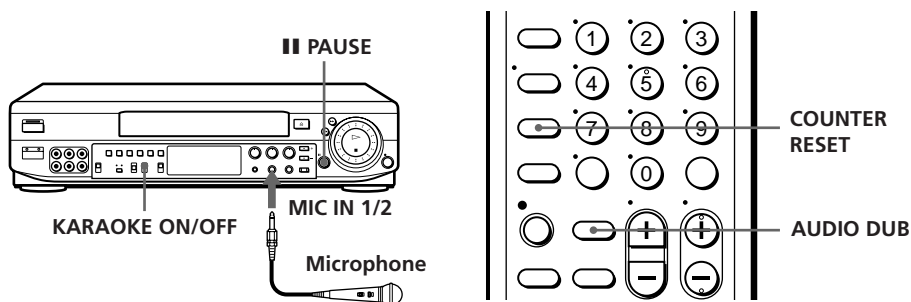

- 1 Set KARAOKE ON/OFF to ON.
- 2 Insert the prerecorded tape into the VCR. Search for the end of the section to be replaced and press **|| PAUSE**.
Make sure that the tape has its safety tab in place.
- 3 Press COUNTER RESET to reset the counter to “0H00M00S.”
- 4 Rewind the prerecorded tape to the beginning of the section to be replaced.
The VCR pauses.
- 5 Press AUDIO DUB.
The audio dubbing indicator \ominus appears in the display window.
- 6 To start editing, press **|| PAUSE** to start dubbing and sing or speak into the microphone.
When the counter reaches “0H00M00S,” audio dubbing stops automatically.

continued

Audio dubbing (continued)

To stop while recording

Press ■ STOP.

To listen to the dubbed sound

Press AUDIO MONITOR until the “L,” “R,” and “STEREO” indicators go off in the display window.

To record sound from the microphone mixed with an external source

If you connect equipment such as a laser disc player to this VCR's LINE 2 IN jacks, you can record while singing along to a karaoke LD. Be sure to press INPUT SELECT to display “L2” before starting recording. The mixed sound is recorded on the normal audio track, and the sound input from the LINE 2 IN jacks is recorded on the hi-fi audio track.

Tip

- When dubbing from the microphone, you can use the functions of echo effect, Key Control, and Self Duet.

Notes

- Do not dub on a tape recorded in LP mode. Audio noise may occur.
- Recording stops if you press COUNTER RESET while audio dubbing.

Troubleshooting

If you have any questions or problems not covered below, please consult your nearest Sony service facility.

	Symptom	Remedy
Power	The ON/STANDBY switch does not function.	<ul style="list-style-type: none"> • Connect the mains lead to mains securely.
	The power is turned on but the VCR does not operate.	<ul style="list-style-type: none"> • Moisture condensation occurs. Turn the power off, unplug the mains lead and leave the VCR to dry for over one hour.
Clock	The clock has stopped and “-:-” lights in the display window.	<ul style="list-style-type: none"> • The clock stops if the VCR is disconnected from the mains for more than an hour. Reset the clock (and timer).
	The playback picture does not appear on the TV screen.	<ul style="list-style-type: none"> • Make sure the TV is set to the video channel. If you are using a monitor, set it to video input.
Playback	The picture is not clear.	<ul style="list-style-type: none"> • Adjust the tracking with the TRACKING +/- buttons. • Make sure the colour system is correctly set to the system that the tape was recorded in. • The video heads are dirty (see below). Clean the video heads using the Sony T-25CLD, E-25CLDR, or T-25CLW video head cleaning cassette. If these cleaning cassettes are not available in your area, have the heads cleaned at your nearest Sony service facility (a standard service fee will be charged). Do not use a commercially available liquid-type cleaning cassette other than Sony's, as it may damage the video heads. • The video heads may have to be replaced. Consult your local Sony service facility for more information.

Symptoms caused by contaminated video heads

- Normal picture
- Rough picture
- Unclear picture
- No picture (or black & white screen appears)

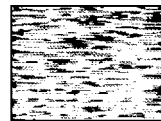

initial



terminal

continued

Troubleshooting (continued)

	Symptom	Remedy
Playback	The picture rolls vertically during picture search.	<ul style="list-style-type: none"> Adjust the vertical hold control on the TV or monitor.
	The picture has no sound.	<ul style="list-style-type: none"> The tape is defective. Use a new tape.
	The sound is unstable or has an echo.	<ul style="list-style-type: none"> When you play a tape with the same sound recorded on both the hi-fi and normal sound tracks, make sure the AUDIO MIX option in the SET UP MENU is set to OFF.
Recording	No TV programmes appear on the TV screen.	<ul style="list-style-type: none"> Make sure the TV is set to the video channel. If you are using a monitor, set it to video input.
	TV reception is poor.	<ul style="list-style-type: none"> Adjust the TV aerial. Make sure SYSTEM, B/G or D/K in the TUNER PRESET menu is set to the system in your area.
	The tape starts playing as soon as it is inserted.	<ul style="list-style-type: none"> The safety tab has been removed. To record on this tape, cover the tab hole.
	The tape is ejected when you press ● REC.	<ul style="list-style-type: none"> Check that the safety tab has not been removed.
	Nothing happens when you press ● REC.	<ul style="list-style-type: none"> Make sure the tape is not at its end. Select the correct source. Select a programme position with the PROG +/- buttons when recording TV programmes; select "L1" or "L2" with the INPUT SELECT button when recording from other equipment.
Timer recording	The timer does not operate.	<ul style="list-style-type: none"> Check that the clock is set. Make sure a tape has been inserted. Check that the safety tab has not been removed. Make sure the tape is not at its end. Make sure a programme has been set for timer recording. Make sure your timer settings have not already passed the current time. Check that the satellite tuner is turned on. The clock stops if the VCR is disconnected from the mains for more than an hour. Reset the clock and timer.

Others	Symptom	Remedy
	A tape cannot be inserted.	<ul style="list-style-type: none"> • Check that a tape isn't already in the tape compartment.
	The remote commander does not function.	<ul style="list-style-type: none"> • Make sure you are pointing the remote commander at the remote sensor on the VCR. • Replace all the batteries in the remote commander with new ones if they are weak. • Make sure the [TV]/[VIDEO] remote control switch is set correctly.
	The tracking indicator does not appear on the screen.	<ul style="list-style-type: none"> • The recording condition of the tape is very poor and tracking cannot be adjusted, or the NTSC system is being used.
	The VCR needs to be cleaned.	<ul style="list-style-type: none"> • Clean the cabinet, panel and controls with a dry, soft cloth, or a soft cloth slightly moistened with a mild detergent solution. Do not use any type of solvent, such as alcohol or benzine.
	The AMS function does not work properly.	<ul style="list-style-type: none"> • The tape has too many blank spaces in a short time span. Change PROGRAM MODE in the SET UP KARAOKE menu from AMS to INDEX.

Specifications

System

Channel coverage

VHF R1 to R12, E2 to E12, NZ1 to NZ11

UHF E21 to E69, R21 to R60

CATV S01 to S05, S1 to S41

RF output signal

UHF channels 21 to 69

Aerial out

75-ohm asymmetrical aerial socket

Inputs and outputs

LINE-1 IN and LINE 2 IN

VIDEO IN, phono jack (1 each)

Input signal: 1 Vp-p, 75 ohms, unbalanced, sync negative

AUDIO IN, phono jack (2 each)

Input level: 327 mVrms

Input impedance: more than 47 kilohms

LINE-1 OUT and LINE 2 OUT

VIDEO OUT, phono jack (1 each)

Output signal: 1 Vp-p, 75 ohms, unbalanced, sync negative

AUDIO OUT, phono jack (2 each)

Standard output: 327 mVrms

Load impedance: 47 kilohms

Output impedance: less than 10 kilohms

General

Power requirements

110 – 240 V AC, 50/60 Hz

Power consumption

28W

Operating temperature

5°C to 40°C

Storage temperature

-20°C to 60°C

Dimensions

Approx. 430 × 100 × 282 mm (w/h/d)

including projecting parts and controls

Mass

Approx. 4.7 kg

Supplied accessories

Remote commander (1)

R6 (size AA) batteries (2)

Aerial cable (1)

Audio/video cable (3-phono to 3-phono) (1)

Microphone (1)

Design and specifications are subject to change without notice.

Index to parts and controls

Refer to the pages indicated in parentheses () for details.

Front panel

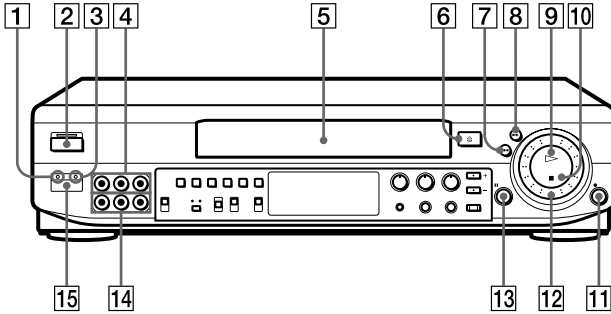

- | | |
|---|--|
| 1 EASY SET UP button (10) | 9 ▷ PLAY button (27) |
| 2 ON/STANDBY switch/indicator (8) | 10 ■ STOP button (28, 32) |
| 3 RF CH SET button (8) | 11 ● REC button (32, 61) |
| 4 LINE 2 IN AUDIO L/R/VIDEO jacks (60) | 12 CLICK SHUTTLE ring (41) |
| 5 Tape compartment | 13 PAUSE button (28, 61) |
| 6 ▲ EJECT button (28) | 14 LINE 2 OUT AUDIO L/R/VIDEO jacks |
| 7 ◀◀ REW button (28, 40) | 15 Remote sensor (5) |
| 8 ▶▶ FF button (28, 40) | |

continued

Index to parts and controls (continued)

Front panel (continued)

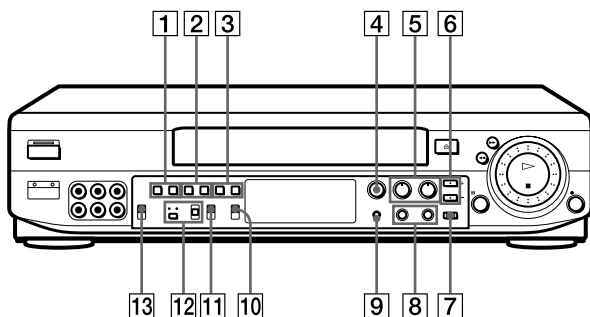

- | | |
|--|---|
| 1 SELF DUET b/# buttons (51) | 8 MIC IN 1/2 jacks (46) |
| 2 KEY CONTROL b/# buttons (50) | 9 CONTROL jack (46) |
| 3 SHOUT button (54)
SCORE button (53) | 10 KARAOKE MODE switch (52) |
| 4 ECHO control (46) | 11 KARAOKE ON/OFF switch (46, 48) |
| 5 MIC VOL 1/2 controls (46) | 12 VIRTUAL SOUND switch (57)
EFFECT button (57) |
| 6 PROGRAM/TRACKING +/-
buttons (9, 58) | WIDE/WARP indicators (57) |
| 7 QUICK TIMER button (42) | 13 COLOR SYSTEM switch (27) |

Display window

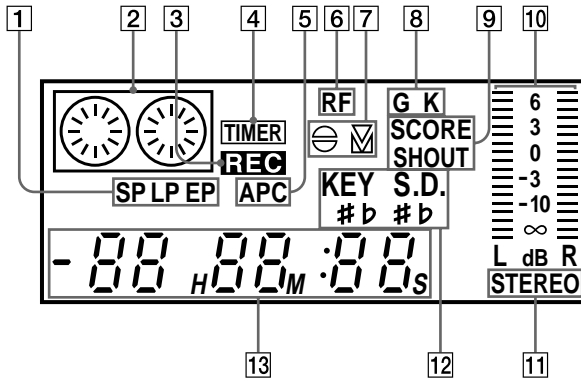

- | | | | |
|---|---|----|--|
| 1 | Tape speed indicator (32) | 8 | TV system indicator (9) |
| 2 | Tape indicator | 9 | SCORE/SHOUT indicator (53, 54) |
| 3 | REC indicator | 10 | Audio channel/sound level indicator (45) |
| 4 | TIMER indicator (35, 38) | 11 | STEREO indicator (44) |
| 5 | APC indicator (58) | 12 | KEY/S.D./#b indicators (50, 51) |
| 6 | RF indicator (8) | 13 | Time counter/clock/line/programme position/pitch adjustment indicator (29, 32, 50) |
| 7 | ⊖ (Audio dub) indicator (62, 63)
☒ (Tracking) indicator (58) | | |

continued

Index to parts and controls (continued)

Rear panel

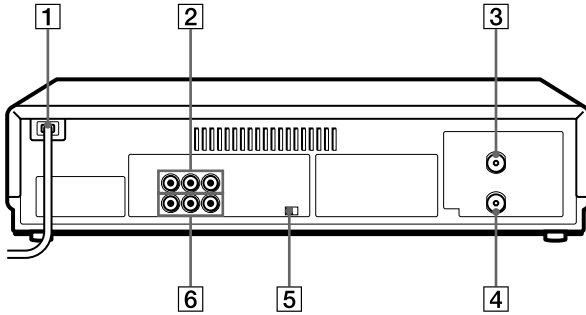

1 Mains lead (6)

2 LINE-1 IN AUDIO L/R/VIDEO
jacks (60)

3 AERIAL OUT connector (6)

4 AERIAL IN connector (6)

5 NTSC PB switch (28)

6 LINE-1 OUT AUDIO L/R/VIDEO
jacks (7)

Remote commander

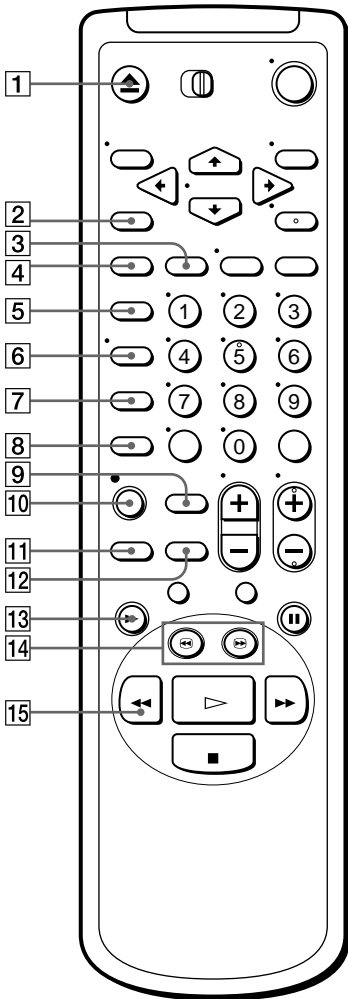

- 1 ▲ EJECT button (28)
- 2 TIMER CLEAR button (24, 35, 43)
- 3 K. PROG button (48)
- 4 SCORE button (53)
- 5 EFFECT button (57)
- 6 DISPLAY button (32)
- 7 COUNTER RESET button (29)
- 8 INPUT SELECT button (33, 37)
- 9 AUDIO DUB button (62)
- 10 ● REC button (32)
- 11 TRINITRON TV SYNCHRO PLAY button (30)
- 12 TAPE SPEED button (32)
- 13 ► SLOW button (40)
- 14 ◀/▶ SEARCH buttons (40)
- 15 ◀◀ REW button (28, 40)

continued

Index to parts and controls (continued)

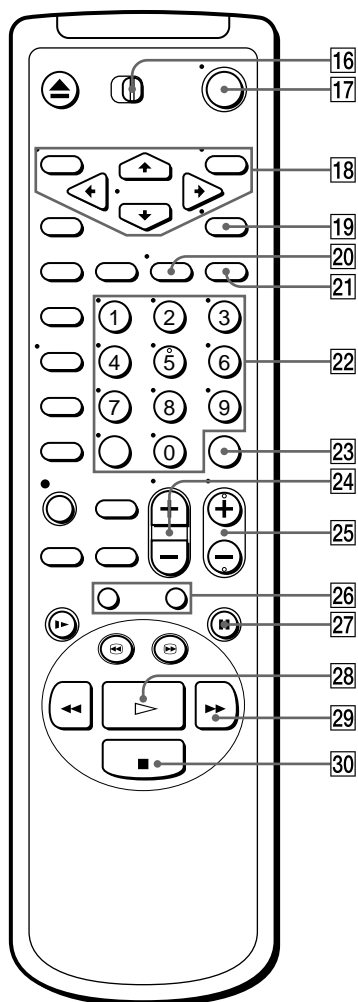

- 16 **TV** / **VIDEO** remote control switch (5)
- 17 **⏻** (on/standby) switch (10)
- 18 Menu buttons (10)
MENU button
CURSOR **↑** / **↓** / **←** / **→** buttons
EXECUTE button
- 19 AUDIO MONITOR button (44, 63)
- 20 TV/VIDEO button (*for TV*) (5)
- 21 G-CODE button (34)
- 22 Programme number / - / - - (ten's digit) buttons (33, 35)
- 23 SET button (35)
- 24 VOL + / - buttons (*for TV*)
- 25 PROG + / - buttons (17, 31)
- 26 **⏮** / **⏭** SEARCH AMS/INDEX buttons (55)
- 27 **⏸** PAUSE button (28)
- 28 **▶** PLAY button (27)
- 29 **⏩** FF button (28, 40)
- 30 **■** STOP button (28)

Index

A, B

- Accessories supplied 4
- Adjusting
 - picture 18, 40, 58
 - tracking 40, 58
- Aerial hookup 6
- AFT (Auto Fine Tuning) 18
- AMS searching 55
- APC (Adaptive Picture Control) 58
- Audio dubbing 62
- Audio track 45
- AV connection 7

C

- Cancelling timer settings 43
- Changing timer settings 43
- Cleaning the video heads 65
- Clock setting 25
- Colour system
 - compatible colour systems 2
 - setting 28
- Connecting
 - to a stereo system 7
 - to a TV with an aerial cable 6
 - to a TV with audio/video jacks 7
- Counter 29

D

- Disabling programme position 18, 24
- Dubbing. *See* Editing

E, F

- EASY SET UP 10
- Editing 60
- EP mode 33

G

- G-CODE
 - recording 34
 - setting 19
- Guide channel setting up 19

H

- Hi-fi audio track 45

I, J

- Index searching 55

K

- Karaoke sing along 46
 - competing for the loudest voice 54
 - grading your singing 53
- Karaoke Pon 52
- Karaoke Program 48
- Key Control 50
- Self Duet 51
- Vocal Assist 52

L

- Language selecting 13
- LP mode 32

M

- Monitoring
 - during playback 44
 - during recording 44

N, O

- Normal audio track 45
- NTSC-recorded tapes 28

P

- Picture adjustment. *See* Adjusting
- Playback 27
 - at various speeds 40
 - slow motion 40
- Presetting channels 14

Q

- Quick timer 42

R

- Recording 31
 - bilingual programmes 44
 - saving 33
 - stereo programmes 44
 - using G-CODE 34
 - while watching another programme 33
- Remote commander 5

S

- Safety tab 33
- Searching
 - at various speeds 40
 - using the index/AMS function 55
- SP mode 32

T, U

- Timer recording 37
 - cancelling timer settings 43
 - changing timer settings 43
 - checking timer settings 43
 - daily/weekly recording 38
 - overlapping timer recordings 42
 - using G-CODE 34
- Tracking adjustment. *See* Adjusting
- Trinitron TV Synchro Play 30

V, W, X, Y

- Virtual Sound 57

Z

- ZWEITON broadcasts 44