

Mini Hi-Fi Component System

Operating Instructions



MHC-W555

WARNING

To prevent fire or shock hazard, do not expose the unit to rain or moisture.

To avoid electrical shock, do not open the cabinet. Refer servicing to qualified personnel only.

Do not install the appliance in a confined space, such as a bookcase or built-in cabinet.

CAUTION

Do not, under any circumstances, place the CD player/stereo cassette deck on top of the A/V control amplifier.

Laser component in this product is capable of emitting radiation exceeding the limit for Class 1.

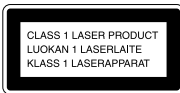

This appliance is classified as a CLASS 1 LASER product. The CLASS 1 LASER PRODUCT MARKING is located on the rear exterior.

This caution label is located inside the unit.



This stereo system is equipped with the Dolby® B-type noise reduction system.

* Dolby noise reduction manufactured under license from Dolby Laboratories Licensing Corporation.

“DOLBY” and the double-D symbol  are trademarks of the Dolby Laboratories Licensing Corporation.

The MHC-W555 consist of the following components:

- A/V control amplifier STR-W555
- CD player/Stereo cassette deck HTC-W555
- Speaker system SS-W777G

Table of Contents

Getting Started

Step 1: Hooking up the system	4
Step 2: Setting the time	6
Step 3: Presetting radio stations	7
Connecting optional AV components .	8

Basic Operations

Playing a CD	11
Recording a CD	13
Listening to the radio	14
Recording from the radio	15
Playing a tape	16
Recording from a tape	17

The CD Player

Using the CD display	19
Playing the CD tracks repeatedly	19
Playing the CD tracks in random order	20
Programming the CD tracks	21
Playing CDs without interruption	22

The Tape Deck

Recording on a tape manually	23
Recording a CD by specifying track order	24

DJ Effects

Looping part of a CD	26
Flashing part of a CD	26

Sound Adjustment

Adjusting the sound	27
Selecting the audio emphasis	28
Adjusting the audio emphasis	29
Making a personal audio emphasis file	30

Other Features

Singing along: Karaoke	32
Falling asleep to music	33
Waking up to music	34
Timer-recording radio programs	35

Additional Information

Precautions	36
Troubleshooting	37
Specifications	40
Index	42

Step 1: Hooking up the system

Do the following procedure **1** to **6** to hook up your system using the supplied cords and accessories.

If you set up the stereo system vertically

Be sure to place the A/V control amplifier on top of the CD player/stereo cassette deck.

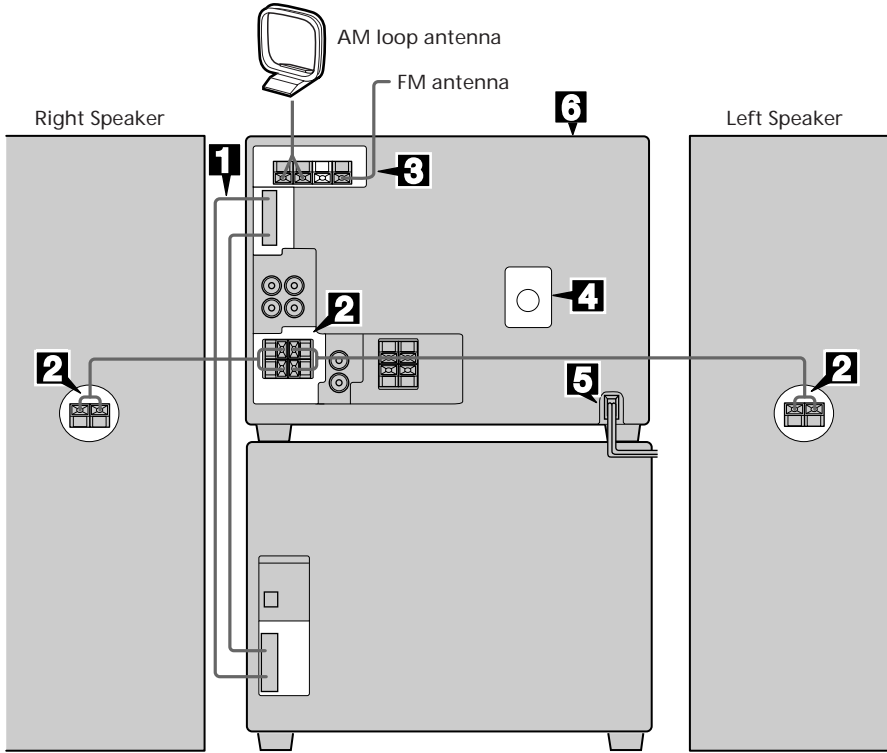

- 1** Connect the flat cord to the SYSTEM CONTROL connectors until it clicks.

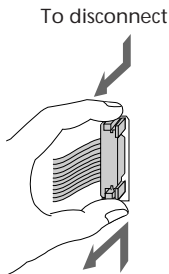

- 2** Connect the speakers.

Connect the speaker cords to the SPEAKER jacks of the same color. Keep the speaker cords away from the antennas to prevent noise.

Insert only the stripped portion.

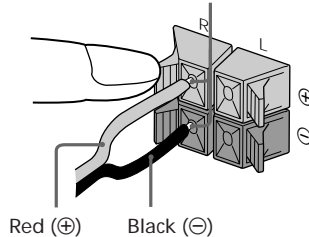

3 Connect the FM/AM antennas.

Set up the AM loop antenna, then connect it.

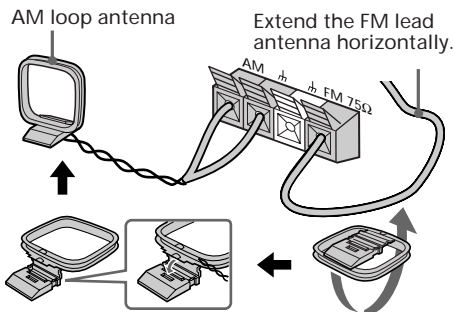

4 Set VOLTAGE SELECTOR to position of your local power line voltage.

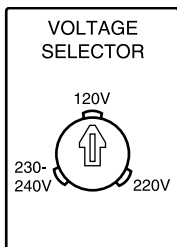

5 Connect the power cord to a wall outlet.

Demo mode appears in the display. If the plug on this unit does not fit your wall outlet, detach the supplied adapter from the plug.

6 Deactivate the demo mode by pressing DISPLAY/DEMO when the system power is turned off.

The demo mode is also deactivated when you set the time.

To activate the automatic sliding panel

Press OPEN/CLOSE to slide the panel. Press OPEN SENSOR ON/OFF, so that AUTO indicator lights up. When you stand within 30 cm from the panel, the panel slides down automatically.

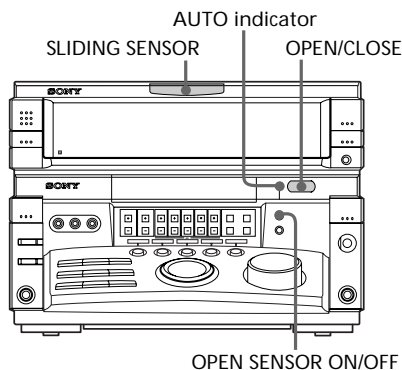

The panel closes automatically if you do not operate on or in the panel for about 30 seconds.

Inserting two size AA (R6) batteries into the remote

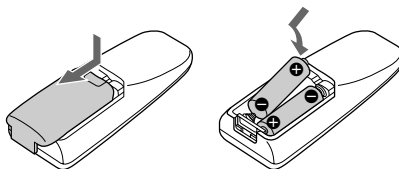

Tip

With normal use, the batteries should last for about six months. When the remote no longer operates the system, replace both batteries with new ones.

Note

If you do not use the remote for a long period of time, remove the batteries to avoid possible damage from battery leakage.

Step 1: Hooking up the system (continued)

When carrying this system

Do the following to protect the CD mechanism.

- 1 Press FUNCTION repeatedly until “CD” appears in the display.
- 2 Hold down LOOP and press I/⏻ (power) so that “LOCK” appears in the display.

To attach the front speaker pads

Attach the supplied front speaker pads to the bottom of the speakers to stabilize the speakers and prevent them from slipping.

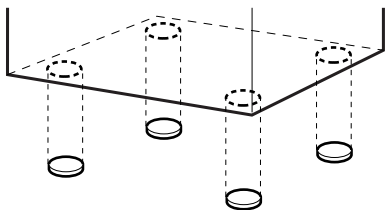

Step 2: Setting the time

You must set the time before using the timer functions.

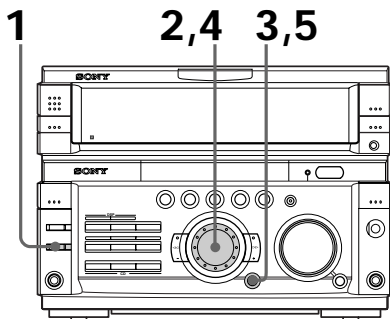

-
- 1 Press CLOCK/TIMER SET.
The hour indication flashes.



-
- 2 Turn the jog dial to set the hour.
The clock is on a 12-hour system.

-
- 3 Press ENTER/NEXT.
The minute indication flashes.



-
- 4 Turn the jog dial to set the minute.

-
- 5 Press ENTER/NEXT.
The clock starts working.
-

Tips

- If you've made a mistake, start over from step 1.
- Setting the time deactivates the demo mode.
If you want to display the demo mode, press DISPLAY/DEMO when the power is off.

Note

The previous explanation shows you how to set the time while the power is off. To change the time while the power is on, do the following:

- 1 Press CLOCK/TIMER SET.
- 2 Turn the jog dial to select SET CLOCK.
- 3 Press ENTER/NEXT.
- 4 Perform steps 2 through 5 above.

Step 3: Presetting radio stations

You can preset up to 40 stations, 20 for FM, 10 for MW and 10 for SW.

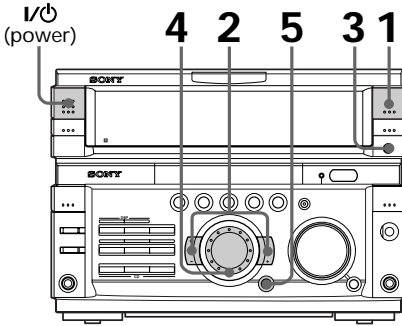

- 1 Press TUNER BAND repeatedly until the band you want appears in the display.

Every time you press this button, the band changes as follows:



- 2 Press and hold ◀◀ - or ▶▶ + until the frequency indication starts to change, then release. Scanning stops when the system tunes in a station. "TUNED" and "STEREO" (for a stereo program) appear.

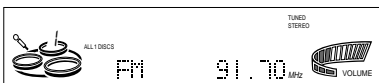

- 3 Press TUNING MEMORY. A preset number appears in the display.

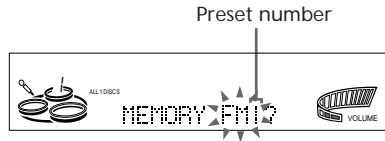

- 4 Turn the jog dial to select the preset number you want.
- 5 Press ENTER/NEXT. The station is stored.
- 6 Repeat steps 1 to 5 to store other stations.

To tune in a station with a weak signal

Press ◀◀ - or ▶▶ + repeatedly to tune in the station manually.

To change the preset number

Start over from step 1.

To change the AM tuning interval

The AM tuning interval is factory-preset to 9 kHz (10 kHz in some areas). To change the AM tuning interval, tune in any AM station first, then turn off the power. While holding down the ENTER/NEXT button, turn the power back on. When you change the interval, AM preset stations will be erased. To reset the interval, repeat the same procedure.

Tip

The preset stations are retained for a day even if you unplug the power cord or if a power failure occurs.

Connecting optional AV components

To enhance your system, you can connect optional components. Refer to the instructions of each component.

Connecting audio components

Select one of the following two connections, depending on the equipment to be connected and method of connecting.

Connecting an MD deck for digital recording

You can record from CD into the MD deck digitally by connecting an optical cable.

To the DIGITAL IN jack of the MD deck

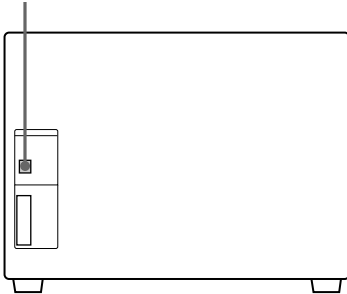

Connecting an MD deck for analog recording

Make sure to match the color of the plugs and the connectors. To listen to the sound of the connected MD deck, press FUNCTION repeatedly until "MD" appears.

To the audio output of the MD deck To the audio input of the MD deck

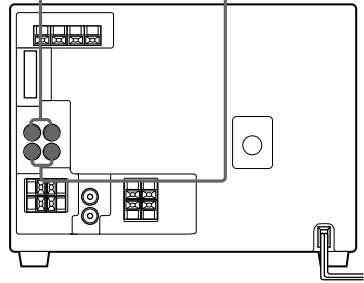

Tip

When you connect a Sony MD deck, you can use the MD ►, ||, and ■ buttons on this unit's remote to perform play, pause and stop operations.

Note

If you cannot select "MD" even when you have pressed FUNCTION, press I/⏻ (power) while pressing FUNCTION when the power is turned off. "VIDEO 1" will be switched to "MD". To return to "VIDEO 1", do the same procedure.

Connecting the surround Speaker

You can connect the optional Surround Speaker.

To the right rear speaker

To the left rear speaker

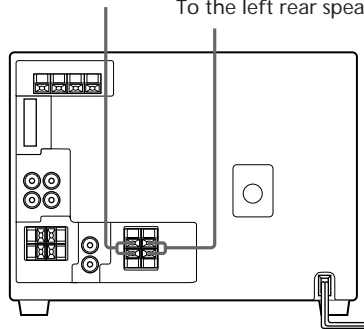

Connecting a super woofer speaker

You can connect an optional super woofer speaker.

To super woofer

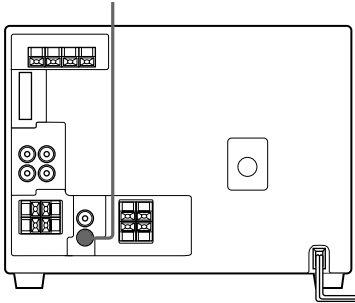

Connecting a VCR

Make sure to match the color of the plugs and the connectors. To listen to the sound of the connected VCR, press FUNCTION repeatedly until "VIDEO 1" appears.

To the audio output of the VCR

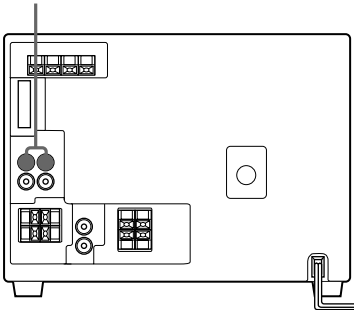

Connecting a video game player

You can enjoy video games with audio emphasis by connecting a video game player. To listen to and watch a video game, press FUNCTION repeatedly until "VIDEO 2" appears.

Press OPEN/CLOSE or place your hand to the sliding sensor to slide the panel. Connect a video game player as shown below:

To the audio/video output of a video game player

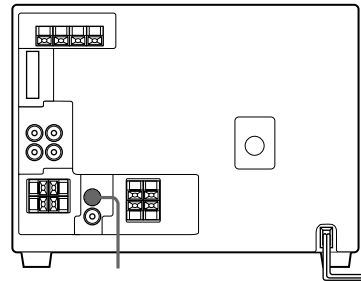
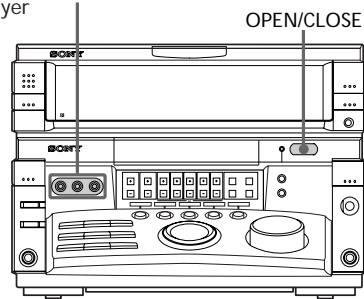

Note

The sliding panel does not close when the AV INPUT jacks are connected.

Connecting optional AV components (continued)

Connecting outdoor antennas

Connect the outdoor antenna to improve the reception.

FM antenna

Connect the optional FM outdoor antenna. You can also use the TV antenna instead.

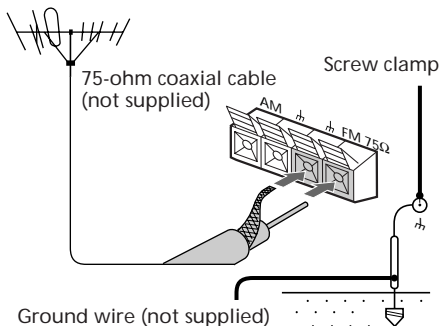

AM antenna

Connect a 6- to 15- meter (20- to 50- feet) insulated wire to the AM antenna terminal. Leave the supplied AM loop antenna connected.

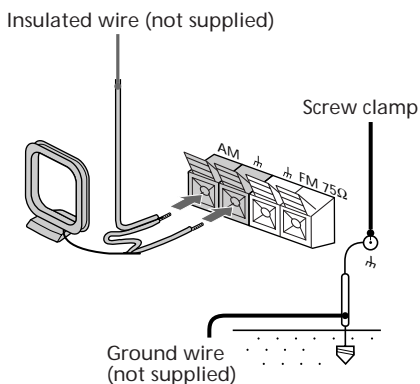

Important

If you connect an outdoor antenna, ground from the terminal with the screw clamp. To prevent a gas explosion, do not connect the ground wire to a gas pipe.

Playing a CD

— Normal play

You can play up to three CDs in a row.

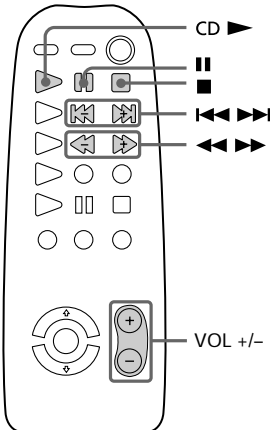
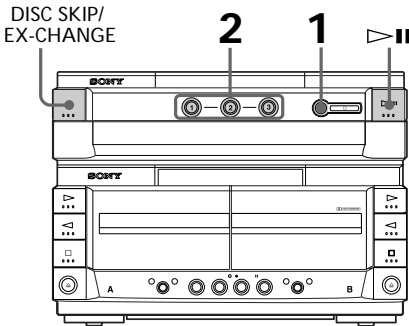
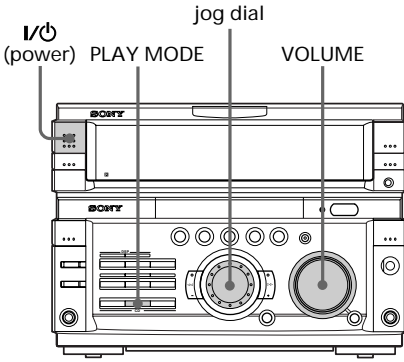

- 1 Press OPEN/CLOSE \blacktriangle and place up to two CDs on the disc tray. If a disc is not placed properly it will not be recognized.

With the label side up. When you play a CD single, place it on the inner circle of the tray.

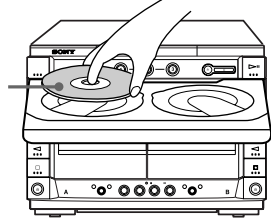

To insert a third disc, press DISC SKIP/EX-CHANGE to rotate the disc tray.

- 2 Press one of the DISC 1~3 buttons. The disc tray closes and play starts. If you press $\blacktriangleright \parallel$ (or CD \blacktriangleright on the remote), play starts from the CD loaded on the tray whose button is lit green.

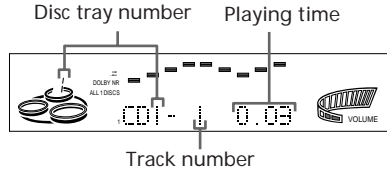

Playing a CD (continued)

To	Do this
Stop play	Press ■ (■ on the remote).
Pause	Press ▷ (on the remote). Press again to resume play.
Select a track	During play or pause, turn the jog dial clockwise (to go forward) or counterclockwise (to go back) and release it when you reach the desired track. (Or press ►► (to go forward) or ◄◄ (to go back) on the remote.)
Find a point in a track	Press and hold down ►► or ◄◄ (or ►►/◄◄ on the remote) during play and release it at the desired point.
Select a CD in stop mode	Press a DISC 1~3 button or DISC SKIP/EX-CHANGE.
Play only the CD you have selected	Press PLAY MODE repeatedly until "1 DISC" appears.
Play all CDs	Press PLAY MODE repeatedly until "ALL DISCS" appears.
Remove the CD	Press OPEN/CLOSE ▲.
Exchange other CDs while playing	Press DISC SKIP/EX-CHANGE.
Adjust the volume	Turn VOLUME (or press VOL +/- on the remote).

Tips

- Pressing ▷|| when the power is off automatically turns the power on and starts CD playback if there is a CD in the tray (One Touch Play).
- You can switch from another source to the CD player and start playing a CD just by pressing ▷|| or the DISC 1~3 buttons (Automatic Source Selection).
- If there is no CD in the player, "CD NO DISC" appears in the display.
- When a disc tray is selected or the CD placed on that tray is playing, the DISC 1~3 button for the respective tray lights green.

Recording a CD

— CD Synchro Recording

The CD SYNCHRO button lets you record from a CD to a tape easily. You can use TYPE I (normal) or TYPE II (CrO₂) tapes. The recording level is adjusted automatically.

DISC SKIP/
EX-CHANGE

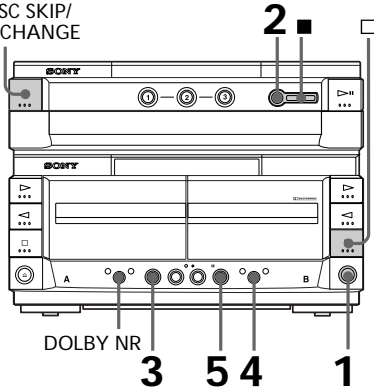

- 1 Press and insert a blank tape into deck B.

With the side you want to record facing forward

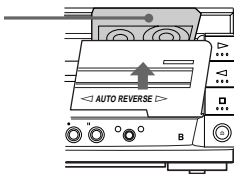

- 2 Press OPEN/CLOSE and place a CD.

Then press again to close the disc tray.

If the indicator for the tray you want to record is not lit green, press DISC SKIP/EX-CHANGE repeatedly so that it lights green.

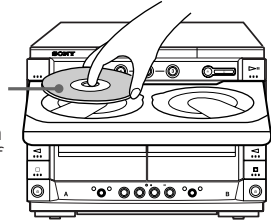

With the label side up. When you play a CD single, place it on the inner circle of the tray.

- 3 Press CD SYNCHRO.

Deck B stands by for recording and the CD player stands by for playback. (for front side) lights up.

- 4 Press DIRECTION MODE repeatedly to select to record on one side. Select (or RELAY) to record on both sides.

- 5 Press PAUSE on deck B. Recording starts.

To stop recording

Press on deck B or on the CD player.

Tips

- If you want to record from the reverse side, press so that (for reverse side) lights up.
- When you record on both sides, be sure to start from the front side. If you start from the reverse side, recording stops at the end of the reverse side.
- When you want to reduce the hiss noise in low-level high-frequency signals, press DOLBY NR so that "DOLBY NR" appears after pressing CD SYNCHRO.

Notes

- You cannot listen to other sources while recording.
- Dolby NR and DIRECTION MODE (or RELAY) is off when the mains AC power supply is switched off.

Listening to the radio

-- Preset Tuning

Preset radio stations in the tuner's memory first (see "Step 3: Presetting radio stations").

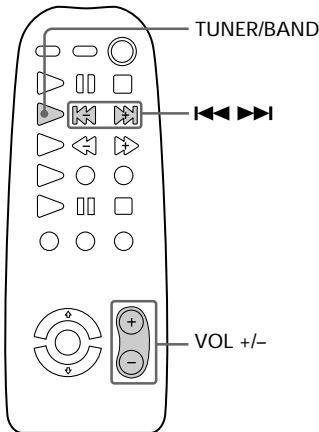
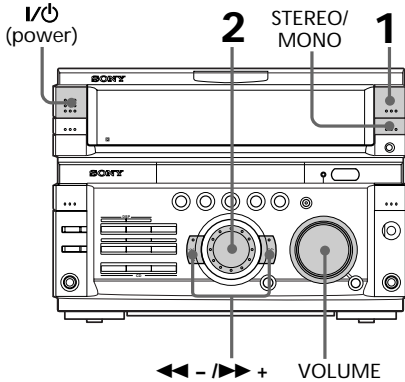

1 Press TUNER BAND repeatedly until the band you want appears in the display.

Every time you press the button, the band changes as follows:

FM → MW → SW



2 Turn the jog dial (or press ◀◀ or ▶▶ on the remote) to tune in the desired preset station.

Turn counter-clockwise (or press ◀◀ on the remote) for lower preset numbers.

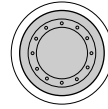

Turn clockwise (or press ▶▶ on the remote) for higher preset numbers.

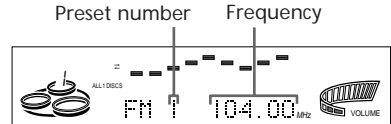

To	Do this
Turn off the radio	Press I/O (power).
Adjust the volume	Turn VOLUME (or press VOL +/- on the remote).

To listen to non-preset radio stations

Use manual or automatic tuning. For manual tuning, press ◀◀ - or ▶▶ + repeatedly. For automatic tuning, press and hold ◀◀ - or ▶▶ +.

Tips

- Pressing TUNER BAND when the power is off automatically turns the power on and tunes to the last received station (One Touch Play).
- You can switch from another source to the radio just by pressing TUNER BAND (Automatic Source Selection).
- When an FM program is noisy, press STEREO/MONO so that "MONO" appears in the display. There will be no stereo effect, but the reception will improve. Press the button again to restore the stereo effect.
- To improve broadcast reception, reorient the supplied antennas.

Recording from the radio

You can record the radio program on a tape by calling up a preset station. You can use TYPE I (normal) or TYPE II (CrO₂) tapes. The recording level is automatically adjusted.

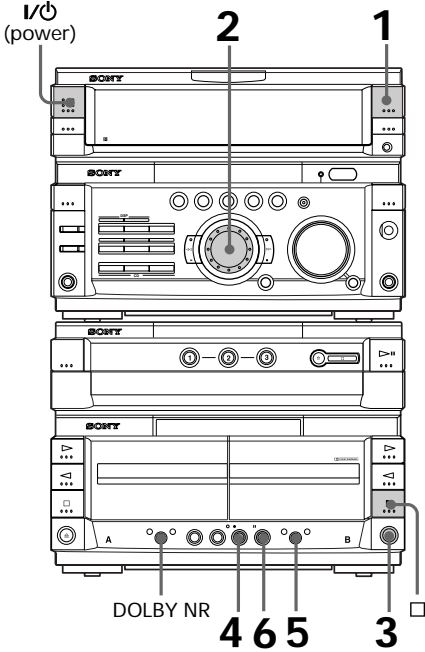

1 Press TUNER BAND to select the band you want.

2 Turn the jog dial to tune in a preset station.

Turn counter-clockwise for lower preset numbers.

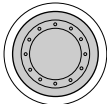

Turn clockwise for higher preset numbers.

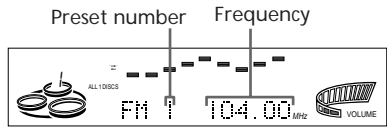

3 Press and insert a blank tape into deck B.

With the side you want to record facing forward

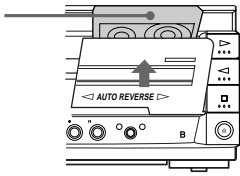

4 Press REC.
Deck B stands by for recording.

5 Press DIRECTION MODE repeatedly to select to record on one side. Select (or RELAY) to record on both sides.

6 Press PAUSE on deck B.
Recording starts.

To stop recording

Press on deck B.

Tips

- If you want to record from the reverse side, press so that (for reverse side) lights up.
- When you record on both sides, be sure to start from the front side. If you start from the reverse side, recording stops at the end of the reverse side.
- To record non-preset stations, use - and + to tune in the desired station manually.
- When you want to reduce the hiss noise in low-level high-frequency signals, press DOLBY NR so that "DOLBY NR ON" appears after pressing REC.
- If noise is heard while recording from the radio, move the respective antenna to reduce the noise.

Note

Dolby NR and DIRECTION MODE (or RELAY) is off when the mains AC power supply is switched off.

Playing a tape

You can use any type of tape, TYPE I (normal), TYPE II (CrO₂) or TYPE IV (metal), since the deck automatically detects the tape type. You can also use the jog dial's AMS* functions to quickly search for songs you want to hear. To select either deck A or B, press DECK A ► or DECK B ► on the remote.

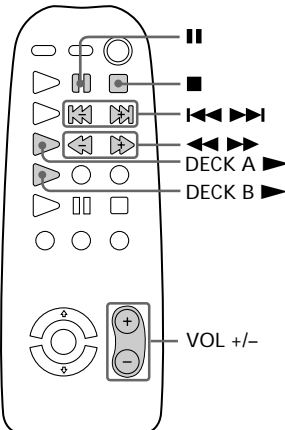
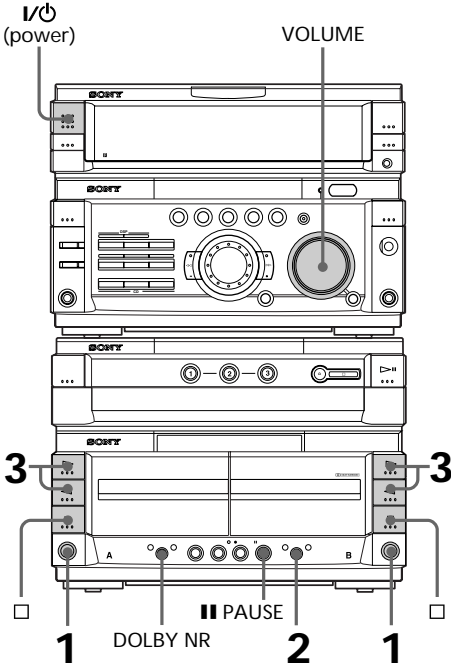

- 1 Press and insert a recorded tape in deck A or B.

With the side you want to play facing forward

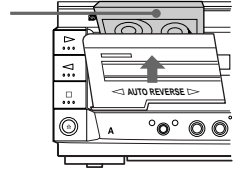

- 2 Press DIRECTION MODE repeatedly to select to play one side. Select ** to play both sides. To play both decks in succession, select RELAY (relay play).***

- 3 Press . Press to play the reverse side. The tape starts playing.

** The deck stops automatically after repeating the sequence five times.

*** Relay play always follows the following sequence:
Deck A (front side), Deck A (reverse side), Deck B (front side), Deck B (reverse side).

To	Do this
Stop play	Press (or on the remote).
Pause (Deck B only)	Press PAUSE. Press again to resume play.
Fast-forward	Press while playing the front side or while playing the reverse side.
Rewind	Press while playing the front side or while playing the reverse side.
Remove the cassette	Press .
Adjust the volume	Turn VOLUME (or press VOL +/- on the remote).

Tips

- Pressing ▷ or ◁ when the power is off automatically turns the power on and starts tape playback if there is a tape in the deck (One Touch Play).
- You can switch from another source to the tape deck just by pressing ▷ or ◁ (Automatic Source Selection).
- If the tape you want to play is recorded with DOLBY NR, you can reduce the noise by pressing the DOLBY NR so that "DOLBY NR ON" appears.
- When dubbing tapes originally recorded with Dolby NR B, the dubbed tape is automatically played with Dolby NR B.

Searching for the beginning of a track (AMS*)

During playback, turn the jog dial the same direction as the ◀ or ▶ indicator to go forward. Turn the opposite direction to go back. (Or press ◀◀ or ▶▶ on the remote.)

The search direction, + (forward) or - (back), and number of songs being skipped (1-9) appear in the display.

Example: searching forward 2 songs

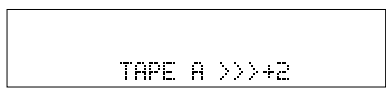

* AMS (Automatic Music Sensor)

Notes

- The AMS function may not operate correctly under the following circumstances:
 - When the unrecorded space between songs is less than 4 seconds long.
 - If completely different information is recorded on the left and right channels.
 - When there are continuous sections of extremely low level or low frequency sound (like those of a baritone sax).
 - When the unit is placed near a television. (In this case, we recommend moving the unit farther away from the television or turning off the television.)
- Dolby NR and DIRECTION MODE (◀↔▶) or RELAY is off when the mains AC power supply is switched off.

Recording from a tape

— High-speed Dubbing

You can use TYPE I (normal) or TYPE II (CrO₂) tapes. The recording level is automatically adjusted.

I/O
(power)

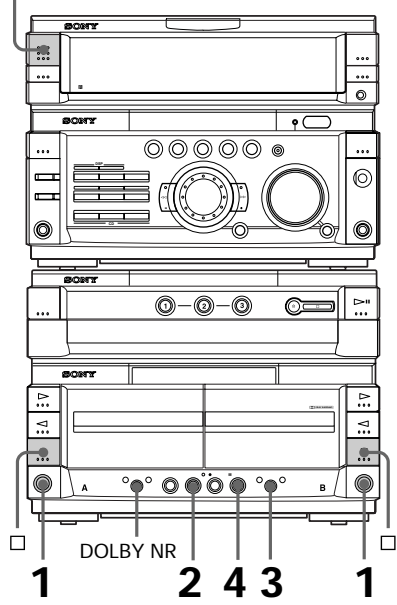

1 Press and insert a recorded tape in deck A and a blank tape in deck B.

With the side you want to play/record facing forward

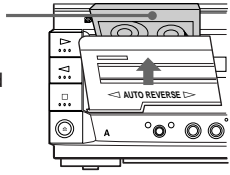

2 Press HI-SPEED DUBBING. Deck B stands by for recording.

continued

Recording from a tape (continued)

3 Press DIRECTION MODE repeatedly to select \rightleftarrows to record on one side. Select \leftrightarrow (or RELAY) to record on both sides.

4 Press **II** PAUSE.
Dubbing starts.

To stop dubbing

Press \square on deck A or B.

Tips

- When you dub on both sides, start recording from the front side. If you record from the reverse side, recording stops at the end of the reverse side.
- If you set DIRECTION MODE to \leftrightarrow when the tapes you use have different lengths, the tape in each deck reverses independently. If you select RELAY, the tapes in both decks reverse together.
- You don't have to set DOLBY NR, since the tape in deck B is automatically recorded in the same state as the tape in deck A.

Note

Dolby NR and DIRECTION MODE (\leftrightarrow or RELAY) is off when the mains AC power supply is switched off.

Using the CD display

You can check the remaining time of the current track or that of the CD.

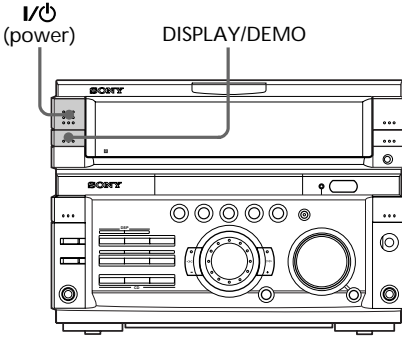

➔ Press DISPLAY/DEMO during playback.

Each time you press the button during normal playback, the display changes as follows:

- Playing time on the current track
- ↓
- Remaining time on the current track
- ↓
- Remaining time on current CD (1 DISC mode) or "PLAY" display (ALL DISCS mode)
- ↓
- Clock display (for eight seconds)
- ↓
- Effect (P FILE) name or "EFFECT ON (OFF)"
- ↓
- Name of spectrum analyzer display pattern.

To check the total playing time and the number of tracks on a CD

Press DISPLAY/DEMO in the stop mode.

If you press DISPLAY/DEMO again, the clock display appears for eight seconds then the display returns to the previous indication.

Playing the CD tracks repeatedly

-- Repeat Play

This function lets you repeat a single CD or all CDs in normal play, Shuffle Play and Program Play.

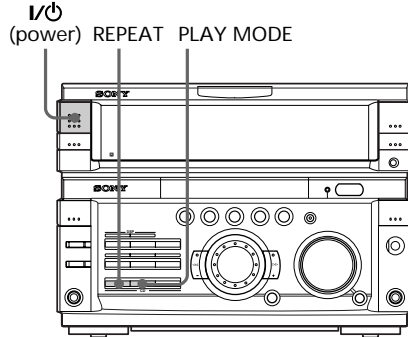

➔ Press REPEAT during playback until "REPEAT" appears in the display.

Repeat Play starts. Do the following procedure to change the repeat mode.

To repeat	Press
All the tracks on the current CD	PLAY MODE repeatedly until "1 DISC" appears in the display.
All the tracks on all CDs	PLAY MODE repeatedly until "ALL DISCS" appears in the display.
Only one track	REPEAT repeatedly until "REPEAT 1" appears in the display while playing the track you want to repeat.

To cancel Repeat Play

Press REPEAT so that "REPEAT" or "REPEAT 1" disappears from the display.

Playing the CD tracks in random order

-- Shuffle Play

You can play all the tracks on one CD or all CDs in random order.

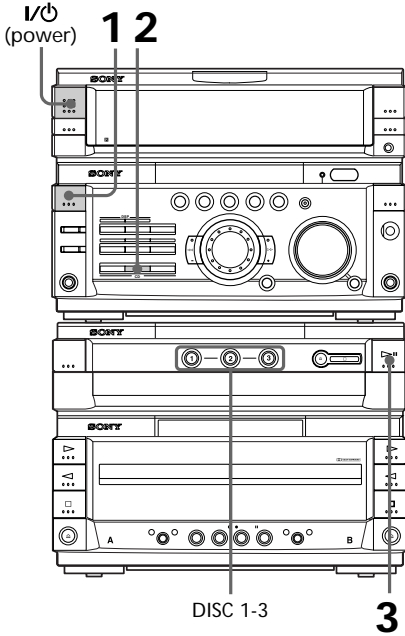

-
- 1** Press **FUNCTION** repeatedly until “CD” appears in the display, then place a CD.

 - 2** Press **PLAY MODE** repeatedly until “1 DISC SHUFFLE” or “ALL DISCS SHUFFLE” appears in the display. “ALL DISCS” shuffles all the CDs in the player. “1 DISC” shuffles the CD whose DISC indicator is green.

 - 3** Press **▷||**. “” appears and then all the tracks play in random order.
-

To cancel Shuffle Play

Press **PLAY MODE** repeatedly until “SHUFFLE” or “PROGRAM” disappears from the display. The tracks continue playing in their original order.

To select a desired CD

Press **DISC 1~3**.

Tips

- You can start Shuffle Play during normal play by pressing **PLAY MODE** repeatedly to select “SHUFFLE”.
- To skip a track, turn the jog dial clockwise (or press **▶▶** on the remote).

Programming the CD tracks

-- Program Play

You can make a program of up to 32 tracks from all the CDs in the order you want them to be played.

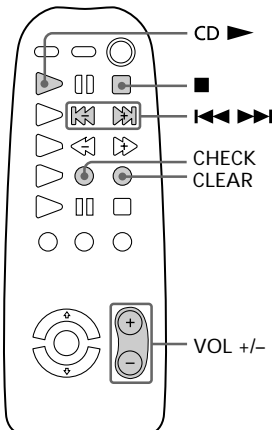
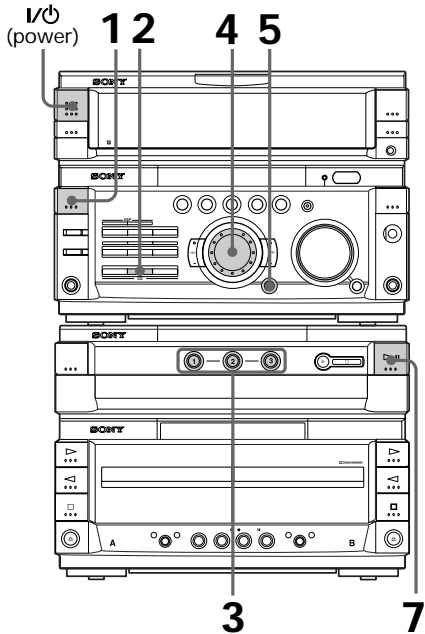

1 Press FUNCTION repeatedly until “CD” appears in the display, then place a CD.

2 Press PLAY MODE repeatedly until “PROGRAM” appears in the display.

3 Press one of the DISC 1~3 buttons to select a CD.

4 Turn the jog dial until the desired track appears in the display.

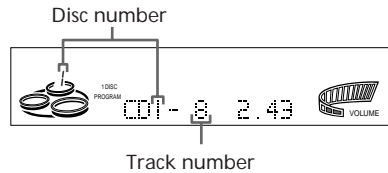

5 Press ENTER/NEXT. The track is programmed. “STEP” and the programmed playing order appear, followed by the total playing time.

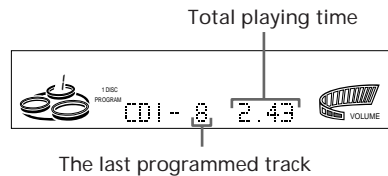

6 To program additional tracks, repeat steps 3 to 5. Skip step 3 to select tracks from the same disc.

7 Press . All the tracks play in the order you selected.

To cancel Program Play

Press PLAY MODE repeatedly until “PROGRAM” or “SHUFFLE” disappears from the display.

Programming the CD tracks (continued)

To	Press
Check the program	CHECK on the remote repeatedly. After the last track, "CHECK END" appears.
Clear a track from the end	CLEAR on the remote in stop mode.
Clear a specific track	CHECK on the remote repeatedly until the number of the track to be erased lights up, then press CLEAR.
Add a track to the program	1 Select the disc tray with a DISC 1-3 button. 2 Select the track by turning the jog dial. 3 Press ENTER/NEXT.
Clear the entire program	■ once in stop mode or twice while playing.

Tips

- The program you made remains in the CD player even after it has been played back. Press ▷|| to play the same program again.
- If "...:" appears instead of the total playing time during programming, this means:
 - you have programmed a track number which exceeds 20
 - the total playing time has exceeded 100 minutes.

Playing CDs without interruption

-- Non-Stop Play

You can play CDs without pausing between tracks.

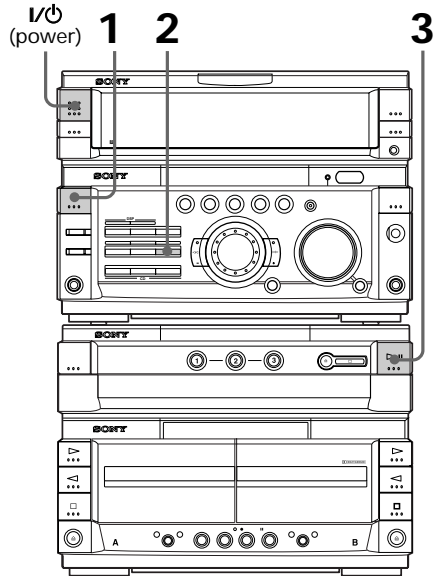

1 Press FUNCTION repeatedly until "CD" appears in the display, then place a CD.

2 Press NON-STOP to light the indicator. "NON-STOP ON" appears in the display.

3 Press ▷||.

To cancel Non-Stop Play

Press NON-STOP so that the indicator goes out and "NON-STOP OFF" appears in the display.

Recording on a tape manually

You can record from CD, tape, or radio as you like. For example, you can record just the songs you want or record from the middle of the tape. The recording level is adjusted automatically.

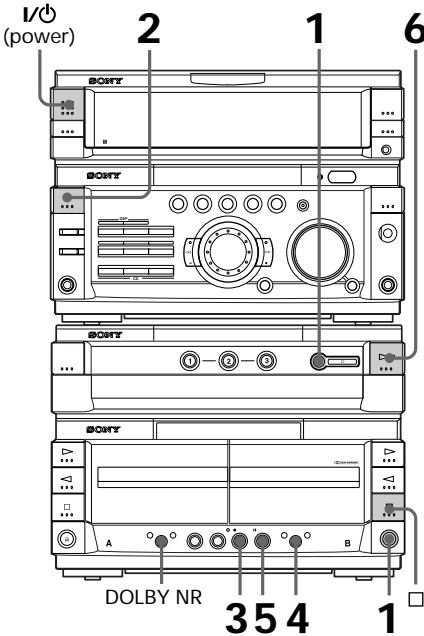

1 Insert a blank tape into deck B.

2 Press FUNCTION repeatedly until the source you want to record (e.g., CD) appears.

3 Press ● REC.
Deck B stands by for recording. ▷ (for front side) lights up.

4 Press DIRECTION MODE repeatedly to select ⇄ to record on one side. Select ↔ (or RELAY) to record on both sides.

5 Press || PAUSE on deck B.
Recording starts.

6 Start playing the source to be recorded.

To	Press
Stop recording	□ on the deck B
Pause recording	PAUSE on the deck B

Tips

- If you want to record from the reverse side, press ◀ so that ◀ (for reverse side) lights up.
- When you want to reduce the hiss noise in low-level high-frequency signals, press DOLBY NR so that "DOLBY NR" appears after pressing ● REC.
- When recording from a CD, you can use the jog dial to select tracks during recording pause mode (after pressing ● REC on step 3 and before pressing || PAUSE in step 5).

Note

Dolby NR and DIRECTION MODE (↔ or RELAY) is off when the mains AC power supply is switched off.

Recording a CD by specifying track order

— Program Edit

You can record tracks from all the CDs in the order you want. When programming, make sure the playing times for each side do not exceed the length of one side of the tape.

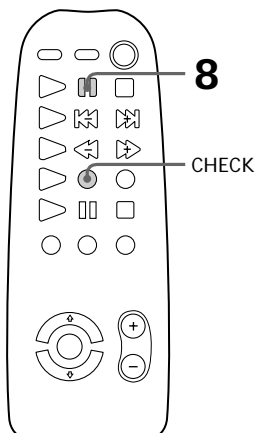
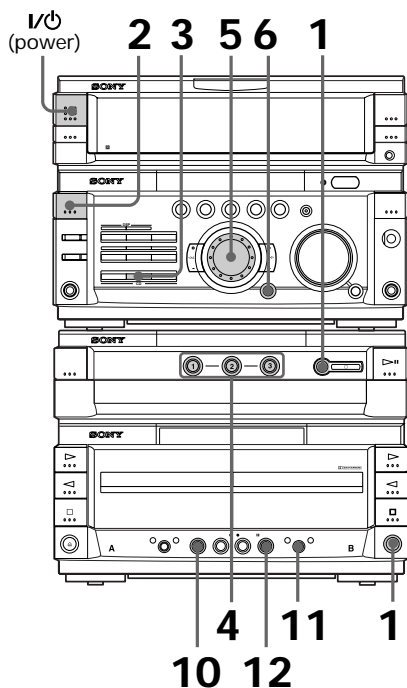

- 1 Place a CD and insert a blank tape into deck B.
- 2 Press FUNCTION repeatedly until “CD” appears in the display.
- 3 Press PLAY MODE repeatedly until “PROGRAM” and “DISC” appear in the display.
- 4 Press one of the DISC 1~3 buttons to select a CD.
- 5 Turn the jog dial until the desired track appears in the display.

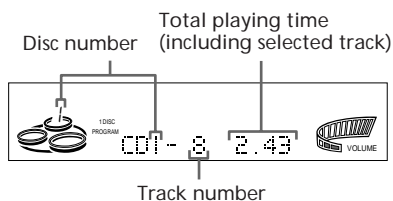

- 6 Press ENTER/NEXT. The track is programmed. “STEP” and the programmed playing order appear, followed by the total playing time.



- 7 To program additional tracks to be recorded on side A, repeat steps 4 to 6. Skip step 4 to select tracks from the same disc.

8 Press **II** on the remote to insert a pause at the end of side A.
“P” appears in the display and the total playing time resets to “0.00” in the display.

9 Repeat steps 5 and 6 for tracks from the same disc or steps 4 to 6 for tracks from another disc to program the remaining tracks to be recorded on side B.

10 Press CD SYNCHRO.
Deck B stands by for recording and the CD player stands by for playback. ▷ (for front side) lights up.

11 Press DIRECTION MODE repeatedly to select ⇌ to record on one side. Select ⇔ (or RELAY) to record on both sides.

12 Press **II** PAUSE on deck B.
Recording starts.

To stop recording

Press □ on the deck B or ■ on the CD player.

To check the order

Press CHECK on the remote repeatedly. After the last track, “CHECK END” appears.

To cancel Program Edit

Press PLAY MODE repeatedly until “PROGRAM” or “SHUFFLE” disappears from the display.

Tip

When you want to reduce the hiss noise in low-level high-frequency signals, press DOLBY NR so that “DOLBY NR” appears after pressing CD SYNCHRO.

Selecting tape length automatically

— *Tape Select Edit*

You can check the most suitable tape length for recording a CD. Note that you cannot use Tape Select Edit for discs containing more than 20 tracks.

1 Insert a CD.

2 Press FUNCTION repeatedly until “CD” appears in the display.

3 Press EDIT once so that “EDIT” flashes. The required tape length for the currently selected CD appears, followed by the total playing time for side A and side B respectively.

Note

You cannot use this function after programming. In order to use this function, you must first cancel the program by pressing PLAY MODE repeatedly until “PROGRAM” or “SHUFFLE” disappears from the display.

Looping part of a CD

— Loop

With the loop function, you can repeat part of a CD during playback. This lets you create original recordings.

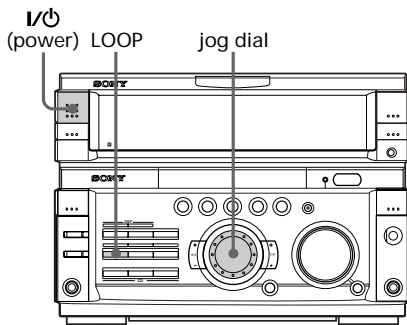

➔ Press and hold LOOP (or LOOP on the remote) during playback at the point you want to start the Loop function, and release to resume normal play.

To adjust the loop length

Turn the jog dial while holding LOOP (or press FILE SELECT $\blacktriangle/\blacktriangledown$ while holding LOOP on the remote) to select different loop lengths (LOOP 1~20).

Flashing part of a CD

— Flash

With the flash function, you can “flash” the CD sound during playback. This lets you create original recordings.

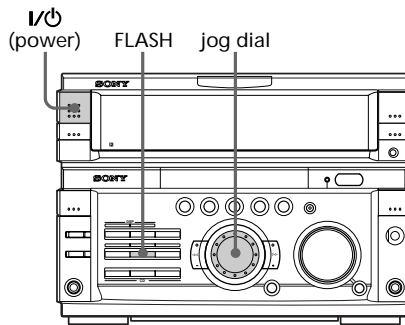

➔ Press and hold FLASH (or FLASH on the remote) during playback at the point you want to start the Flash function, and release to resume normal play.

To adjust the flash length

Turn the jog dial while holding FLASH (or press FILE SELECT $\blacktriangle/\blacktriangledown$ while holding FLASH on the remote) to select different flash lengths (FLASH 1~20).

To use LOOP and FLASH together

Press and hold both LOOP and FLASH (or LOOP and FLASH on the remote) at the same time.

Notes

- The loop and flash length cannot be adjusted during this operation. Adjust the loop and flash lengths independently beforehand if necessary.
- To record the flash effect, use the analog MD/VIDEO 1 OUT connections or this unit's tape deck.

Adjusting the sound

You can reinforce the bass, create a more powerful sound, and listen with headphones.

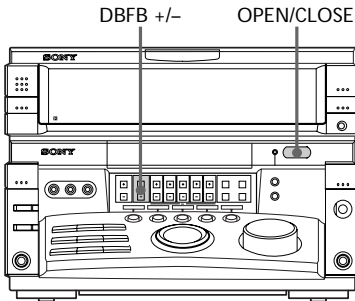
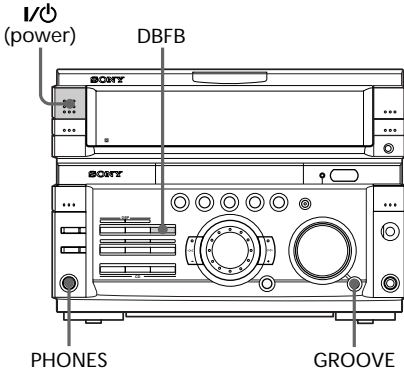

To reinforce bass (DBFB)

1 Press DBFB*.

Every time you press the button, the display changes as follows:

DBFB (level) → DBFB OFF

↑

2 Press OPEN/CLOSE or place your hand to the sliding sensor to slide the panel.

Press DBFB + or DBFB - to adjust DBFB level.

The display change as follows:

DBFB MAX ↔ DBFB HIGH ↔ DBFB MID ↔ DBFB LOW

* DBFB = Dynamic Bass Feedback

For a powerful sound (GROOVE)

Press GROOVE. The volume switches to power mode, DBFB is automatically set to full strength, the equalizer curve changes, and the GROOVE button lights up. Press GROOVE again to return to the previous volume.

Notes

- With some songs, the music will sound distorted when you use the DBFB system with the graphic equalizer if the bass is too strong. Adjust the bass slowly while listening to music so that you can monitor the effect of the adjustment.
- Canceling GROOVE sets DBFB to DBFB LOW and flattens the equalizer curve. Press DBFB +/- to adjust DBFB level. Adjust the equalization to obtain the effect you desire.

To listen through the headphones

Connect the headphones to PHONES jack. No sound will come from the speakers.

Selecting the audio emphasis

The audio emphasis menu lets you select the sound characteristic according to the sound you are listening to.

The personal file function (see “Making a personal audio emphasis file”) lets you store your own effects.

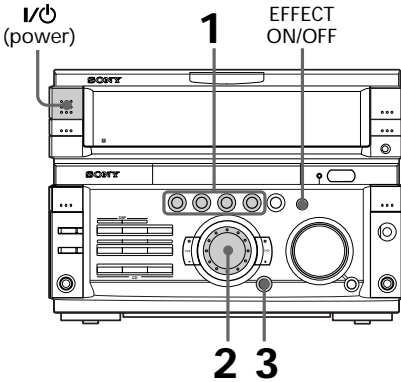

- 1** Press MOVIE, MUSIC, GAME, or PLACE to select a menu.
See the chart “Music menu options” below. The last effect chosen from that menu appears in the display.
- 2** Use the jog dial (or press FILE SELECT \uparrow/\downarrow on the remote repeatedly) to select the preset you desire.
The preset name appears in the display.
- 3** Press ENTER/NEXT.
You don’t need to press ENTER/NEXT when you use the remote.

To cancel the effect

Press EFFECT ON/OFF repeatedly (or FILE SELECT ON/OFF on the remote) so that “EFFECT OFF” appears in the display.

Music menu options

“SUR $\blacksquare\blacksquare\blacksquare\blacksquare$ ” appears if you select an effect with surround effects.

MENU button	Effect	For
MOVIE	ACTION ROMANCE SF DRAMA SPORTS	Soundtracks and special listening situations
MUSIC	ROCK POP JAZZ DANCE SOUL	Standard music sources
GAME	SHOOTING RACING RPG BATTLE ADVENTURE	Video games
PLACE	DISCO CLUB LIVE HOUSE CHURCH CONCERT HALL	Special listening locations
P FILE	P FILE 1 ~ 5	Personal music file

To change the spectrum analyzer display

Press DISPLAY/DEMO repeatedly to select one of the displays below.

Spectrum analyzer

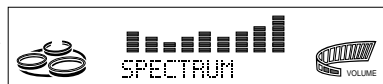

Graphic equalizer curve



Note

The spectrum analyzer display changes each time you cycle through the information display (e.g. function → clock → effect)

Adjusting the audio emphasis

You can adjust the audio emphasis using the graphic equalizer and surround effect.

Adjusting the graphic equalizer

You can adjust the sound by raising or lowering the levels of specific frequency ranges.

Before operation, first select the audio emphasis you want for your basic sound.

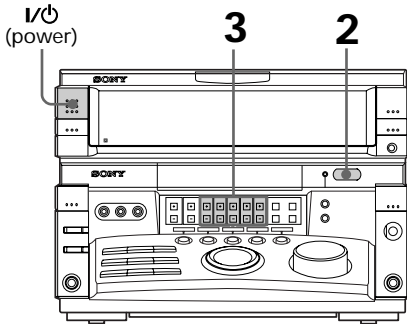

- 1 Select the audio emphasis you want for your basic sound (see “Selecting the audio emphasis”).
- 2 Press OPEN/CLOSE or place your hand to the sliding sensor to slide the panel.
- 3 Press EQ +/- button for the desired frequency band to adjust level.

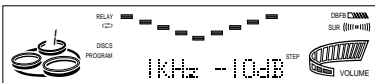

Note

If you choose another menu of audio emphasis (other than “EFFECT OFF”), the adjusted sound effect is lost. To retain the adjusted sound effect for future use, store it in a personal file. (See “Making a personal audio emphasis file”.)

Activating the surround effect

You can enjoy the surround effect.

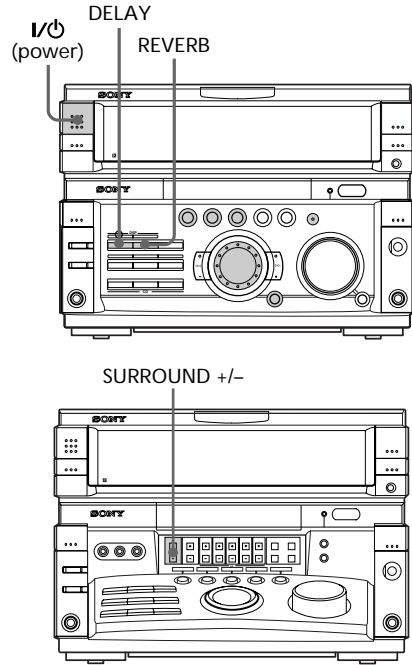

- ➔ Press DSP - DELAY or REVERB to activate the delay or reverb effects. “DELAY” or “REVERB” appear in the display.

To adjust the surround level

Press OPEN/CLOSE or place your hand to the sliding sensor to slide the panel. Press SURROUND +/- to adjust level. The Delay level and the reverb level are adjusted at the same time.

Note

When you choose other sound effects, the surround effects will be canceled. If you want to memorize the effect, store it into a personal file (see “Making a personal audio emphasis file”).

Making a personal audio emphasis file

— Personal file

You can create a personal file of audio patterns (surround effect and graphic equalizer) and store them in the memory of the unit. Later call up an audio pattern to play a favorite tape, CD, or radio program. Create up to five audio files.

Before operation, first select the audio emphasis you want for your basic sound.

1 Obtain the sound effect you want by using the graphic equalizer and surround effect. (See “Adjusting the Audio Emphasis”)

2 Press EQ MEMORY.
The personal file number appears in the display.



3 Use the jog dial to select the file number (P FILE) where you want to store the sound effect.

4 Press ENTER/NEXT.
The adjusted sound effects are stored under the selected file number. The settings previously stored at this memory location are erased and replaced by the new settings.

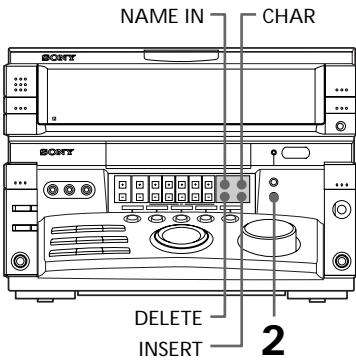
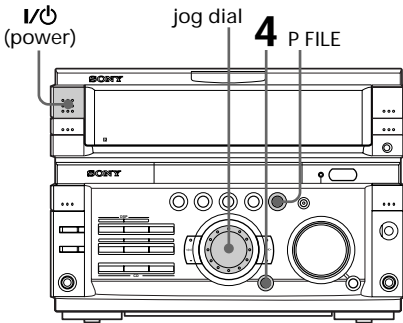

Naming the personal file

- 1 Press OPEN/CLOSE or place your hand to the sliding sensor to slide the panel. Press NAME IN.



- 2 Use the jog dial to select the file number you want to name.
- 3 Press ENTER/NEXT.

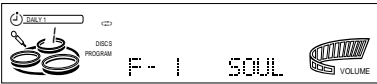

- 4 Use the jog dial to select a character then press ►► + to enter the next character.
- 5 Press ENTER/NEXT when you have entered the file name. The file name is stored.

Tips

- To change the type of characters quickly, press CHAR.
- To move to the previous character, press ◀◀ -.
- To delete the character, press DELETE.
- To insert a character, press INSERT.

To call up the personal file

- 1 Press P FILE to display the last selected personal file.
- 2 Use the jog dial (or press FILE SELECT ▲/▼ on the remote repeatedly) to select the personal file you desire.
- 3 Press ENTER/NEXT.
You don't need to press ENTER/NEXT when you use the remote.

Tip

The programmed P file will be retained for a day if the power cord is unplugged or there is a power failure.

Singing along: Karaoke

You can sing along with any stereo CD or tape by turning down the singer's voice. You need to connect an optional microphone.

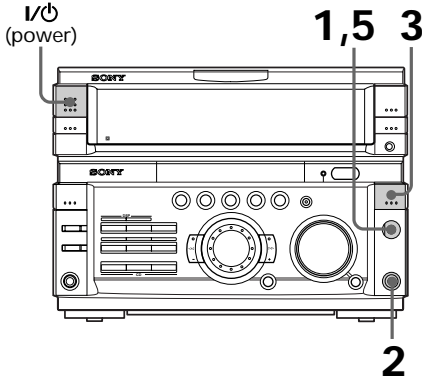

- 1 Turn MIC LEVEL to MIN to turn down the microphone control level.
- 2 Connect an optional microphone to MIX MIC.
- 3 Press KARAOKE PON/MPX repeatedly to obtain the karaoke effect you desire.

Every time you press the button, the display changes as follows:

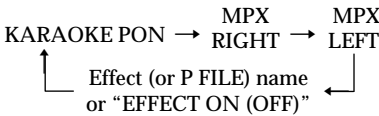

The indicator appears in the display when a karaoke mode is activated. To sing karaoke with decreasing the vocal level of a CD, select KARAOKE PON. To sing karaoke of multiplex CD or tape, select MPX RIGHT or MPX LEFT.

- 4 Start playing the music and adjust the volume.

- 5 Adjust the microphone volume by turning MIC LEVEL.

When you are done

Turn MIC LEVEL to MIN and disconnect the microphone from MIX MIC, then press KARAOKE PON/MPX repeatedly so that disappears.

Mixing and recording sounds

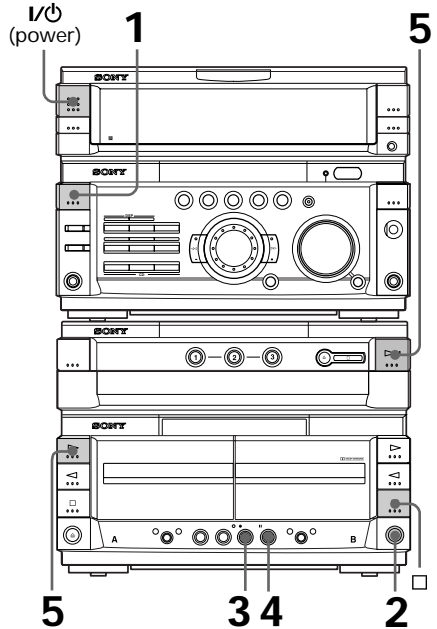

- 1 Press FUNCTION repeatedly to select the source you desire and set it to pause mode.
- 2 Do the above steps 1 to 5. Then, insert a tape in deck B.

3 Press ● REC.

4 Press || PAUSE.

5 Start playing the source selected in step 1.
Playback starts. Start singing along with the music.

To stop recording

Press □ on deck B.

Tips

- If acoustic feedback (howling) occurs, move the microphone away from the speakers or change the direction of the microphone.
- If you want to record your voice through the microphone only, you can do so by selecting the CD function and not playing a CD.

Notes

- If you press EFFECT ON/OFF or recall a sound effect, the karaoke mode is cancelled.
- The instrumental sound may be reduced as well as the singer's voice when the sound is recorded in monaural.
- The singer's voice may not be reduced when:
 - only a few instruments are playing
 - a duet is being played
 - the source has strong echoes or chorus
 - the singer's voice deviates from the center.
 - the voice on the source is singing in high soprano or tenor.

Falling asleep to music

— Sleep Timer

You can let the system turn off at the preset time, so you can sleep to the music. You can preset the time to be turned off by 10 minutes.

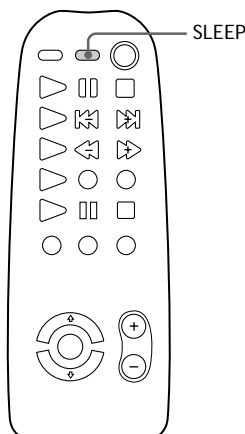

➔ Press SLEEP on the remote.

Every time you press the button, the minute display (the turn-off time) changes as follows:

AUTO → 90min → 80min → 70min
→ ... → 10min → OFF → AUTO ...

When you choose "AUTO"

The power turns off when the current CD or tape finishes playback (for up to 100 minutes).

To check the remaining time

Press SLEEP on the remote once.

To change the time to turn off

Select the time you want by pressing SLEEP on the remote.

To cancel the Sleep Timer function

Press SLEEP on the remote repeatedly until "SLEEP OFF" appears.

Waking up to music

— Wake-up Timer

You can wake up to music at a preset time every day. Make sure you have set the clock (see “Step 2: Setting the time”).

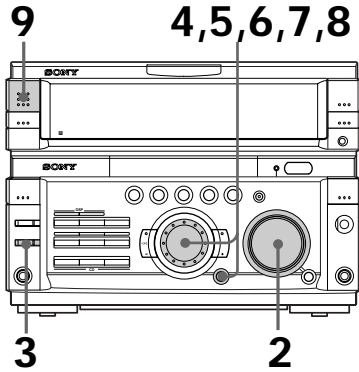

1 Prepare the music source you want to play.

- CD: Insert a CD. To start from a specific track, make a program (see “Programming the CD tracks”).
- Tape: Insert a tape with the side you want to play facing forward.
- Radio: Tune in the preset station you want (see “Step 3: Presetting radio stations”).

2 Adjust the volume.

3 Press CLOCK/TIMER SET.
“SET (DAILY 1)” appears.

4 Turn jog dial to select DAILY 1 or 2, then press ENTER/NEXT.
“ON” appears and the hour digits flash in the display.



5 Set the time to start playback.
Turn jog dial to set the hour, then press ENTER/NEXT.
The minute indication starts flashing.

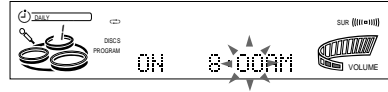

Turn jog dial to set the minute, then press ENTER/NEXT.
The hour indication flashes again.

6 Set the time to stop playback following the above procedure.

7 Turn jog dial until the music source you want appears.

The indications change as follows:

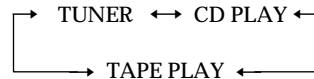

8 Press ENTER/NEXT.
The type of timer (DAILY 1 or DAILY 2), followed by the start time, stop time and the music source, appears, then the original display appears.

9 Turn off the power.

To check the setting

Press TIMER SELECT and turn the jog dial to select the respective mode (DAILY 1 or DAILY 2), then press ENTER/NEXT. To change the setting, start over from step 1.

To cancel the timer operation

Press TIMER SELECT and turn the jog dial to select “TIMER OFF”, then press ENTER/NEXT.

Tip

The power turns on 15 seconds before the preset time.

Timer-recording radio programs

To timer-record, you must preset the radio station (see “Step 3: Presetting radio stations”) and set the clock (see “Step 2: Setting the time”) beforehand.

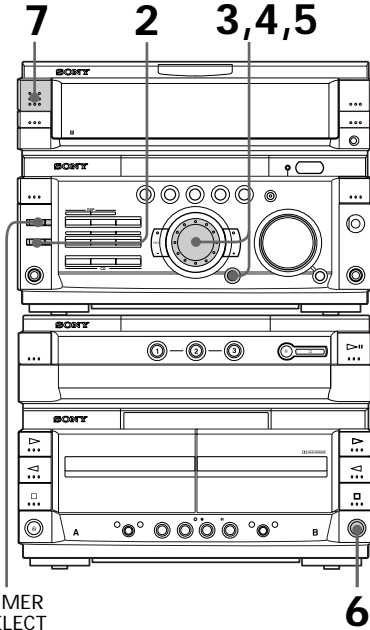

- 1** Tune in the preset radio station (see “Listening to the radio”).
- 2** Press **CLOCK/TIMER SET**. “SET (DAILY 1)” appears.
- 3** Turn jog dial to select “REC”, then press **ENTER/NEXT**. “ON” appears and the hour digits flash in the display.



- 4** Set the time to start recording.
Turn jog dial to set the hour, then press **ENTER/NEXT**.
The minute indication starts flashing.

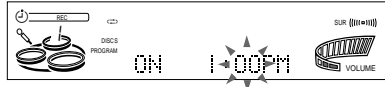

- 5** Turn jog dial to set the minute, then press **ENTER/NEXT**.
The hour indication flashes again.

- 5** Set the time to stop recording following the above procedure.
The start time appears, followed by the stop time, the recording source and the radio station, then the original display appears.

- 6** Insert a recordable tape.

- 7** Turn off the power.
When the recording starts, the volume level is set to the minimum.

To check the setting

Press **TIMER SELECT** and turn the jog dial to select “REC”, then press **ENTER/NEXT**. To change the setting, start over from step 1.

To cancel the timer operation

Press **TIMER SELECT** and turn the jog dial to select “TIMER OFF”, then press **ENTER/NEXT**.

Note

If the power is on at the preset time, the recording will not be made.

Precautions

On operating voltage

Before operating the system, check that the operating voltage of your system is identical with the voltage of your local power supply.

On safety

- The unit is not disconnected from the AC power source (mains) as long as it is connected to the wall outlet, even if the unit itself has been turned off.
- Unplug the system from the wall outlet (mains) if it is not to be used for an extended period of time. To disconnect the cord (mains lead), pull it out by the plug. Never pull the cord itself.
- Should any solid object or liquid fall into the component, unplug the stereo system and have the component checked by qualified personnel before operating it any further.
- The AC power cord must be changed only at the qualified service shop.

On placement

- Place the stereo system in a location with adequate ventilation to prevent heat build-up in the stereo system.
- Do not place the unit in an inclined position.
- Do not place the unit in locations where it is;
 - Extremely hot or cold
 - Dusty or dirty
 - Very humid
 - Vibrating
 - Subject to direct sunlight

On operation

- If the stereo system is brought directly from a cold to a warm location, or is placed in a very damp room, moisture may condense on the lens inside the CD player. Should this occur, the system will not operate properly. Remove the CD and leave the system turned on for about an hour until the moisture evaporates.
- When you move the system, take out any discs.

If you have any questions or problems concerning your stereo system, please consult your nearest Sony dealer.

Notes on CDs

- Before playing, clean the CD with a cleaning cloth. Wipe the CD from the center out.
- Do not use solvents such as benzene, thinner, commercially available cleaners or anti-static spray intended for vinyl LPs.
- Do not expose the CD to direct sunlight or heat sources such as hot air ducts, nor leave it in a car parked in direct sunlight.

Cleaning the cabinet

Use a soft cloth slightly moistened with mild detergent solution.

To remove the speaker grille

Use both hands and pull the grille straight forward to prevent the ribs from breaking.

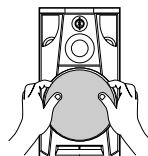

To save a tape permanently

To prevent a tape from being accidentally recorded over, break off the cassette tab from side A or B as illustrated.

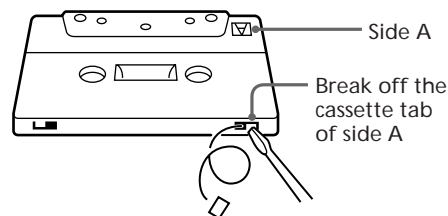
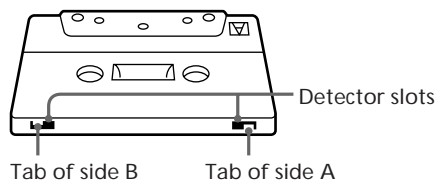

If you later want to reuse the tape for recording, cover the broken tab with adhesive tape. However, be careful not to cover the detector slots which allow the tape player to automatically detect the type of tape.

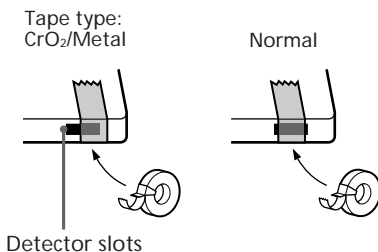

Before placing a cassette in the tape deck

Take up any slack in the tape. Otherwise the tape may get entangled in the parts of the tape deck and become damaged.

When using a tape longer than 90 minutes

The tape is very elastic. Do not change the tape operations such as play, stop, and fast-winding etc. frequently. The tape may get entangled in the tape deck.

Cleaning the tape heads

Clean the tape heads after every 10 hours of use.

When the tape heads become dirty

- the sound is distorted
- there is a decrease in sound level
- the sound drops out
- the tape does not erase completely
- the tape does not record

Make sure to clean the tape heads before you start an important recording or after playing an old tape. Use separately sold dry-type or wet-type cleaning cassette. For details, refer to the instructions of the cleaning cassette.

Demagnetizing the tape heads

Demagnetize the tape heads and the metal parts that have contact with the tape every 20 to 30 hours of use with a separately sold demagnetizing cassette. For details, refer to the instructions of the demagnetizing cassette.

Troubleshooting

If you run into any problem using this stereo system, use the following check list.

First, check that the power cord is connected firmly and the speakers are connected correctly and firmly.

Should any problem persist, consult your nearest Sony dealer.

General

The display starts flashing as soon as you plug in the power cord even though you haven't turned on the power (demonstration mode).

- Press DISPLAY/DEMO when the power is turned off.

The demonstration mode appears automatically the first time you plug in the power cord. If there is a power outage lasting longer than a day, do the following again:

- Clock setting (see "Step 2: Setting the time")
- Preset stations (see "Step 3: Presetting radio stations")
- Timer settings (see "Waking up to music" and "Timer-recording radio programs").

"12:00 AM" flashes in the display.

- A power interruption occurred. Set the clock and timer settings again.

There is no sound.

- Rotate VOLUME clockwise.
- The headphones are connected.
- Insert only the stripped portion of the speaker cord into the SPEAKER jack. Inserting the vinyl portion of the speaker cord will obstruct the speaker connections.

Troubleshooting (continued)

There is severe hum or noise.

- A TV or VCR is placed too close to the stereo system. Move the stereo system away from the TV or VCR.
-

The sound from the connected source is distorted.

- If “VIDEO 1” appears in the display when you press FUNCTION, switch the display to “MD” (see “Notes: Connecting a VCR” on page 9).
-

The timer does not function.

- Set the clock correctly.
-

DAILY1, DAILY 2, and REC do not appear when you press the TIMER SELECT button.

- Set the timer correctly.
 - Set the clock.
-

The remote does not function.

- There is an obstacle between the remote and the system.
 - The remote is not pointing in the direction of the system’s sensor.
 - The batteries have run down. Replace the batteries.
-

There is acoustic feedback.

- Decrease the volume level.
 - Move the microphone away from the speakers or change the direction of the microphone.
-

The color irregularity on a TV screen persists.

- Turn off the TV set once, then turn it on after 15 to 30 minutes. If the color irregularity still persists, place the speaker farther away from the TV set.
-

Speakers

Sound comes from one channel or unbalanced left and right volume.

- Check the speaker connection and speaker placement.
-

Sound lacks bass.

- Check that the speaker’s + and – jacks are connected correctly.
-

CD Player

The CD tray does not close.

- The CD is not placed properly.
-

The CD will not play.

- The CD is not lying flat in the disc tray.
 - The CD is dirty.
 - The CD is inserted label side down.
 - Moisture condensation has built up. Remove the CD and leave the system turned on for about an hour until the moisture evaporates.
-

Play does not start from the first track.

- The player is in program or shuffle mode. Press PLAY MODE repeatedly until “PROGRAM” or “SHUFFLE” disappear.
-

“OVER” is displayed.

- You have reached the end of the CD. Press and hold ◀◀ to return.
-

Tape Deck

The tape does not record.

- No tape in the cassette holder.
- The tab has been removed from the cassette (see “To save a tape permanently” on page 36).
- The tape has reeled to the end.

The tape does not record nor play or there is a decrease in sound level.

- The heads are dirty. Clean them (see “Cleaning the tape heads” on page 37).
- The record/playback heads are magnetized. Demagnetize them (see “Demagnetizing the tape heads” on page 37).

The tape does not erase completely.

- The record/playback heads are magnetized. Demagnetize them (see “Demagnetizing the tape heads” on page 37).

There is excessive wow or flutter, or the sound drops out.

- The capstans or pinch rollers are dirty. Clean them (see “Cleaning the tape heads” on page 37).

Noise increases or the high frequencies are erased.

- The record/playback heads are magnetized. Demagnetize them (see “Demagnetizing the tape heads” on page 37).

After pressing **▶** (**◀**) or **⏏**, there is a mechanical noise, “EJECT” appears in the display, and the unit enters standby mode automatically.

- The cassette tape was not inserted correctly. Eject the tape and turn the power back on.
-

Tuner

Severe hum or noise (“TUNED” or “STEREO” flashes in the display.)

- Adjust the antenna.
- The signal strength is too weak. Connect the external antenna.

A stereo FM program cannot be received in stereo.

- Press STEREO/MONO so that “STEREO” appears.
-

If other troubles not described above occur, reset the system as follows:

- 1 Unplug the power cord.
- 2 Plug the power cord back in.
- 3 Press DISPLAY/DEMO, ENTER/NEXT, and EDIT at the same time.

Specifications

Amplifier section

The following measured at AC 230 V, 50/60 Hz
DIN power output (rated)

95 + 95 watts
(6 ohms at 1 kHz, DIN)

Continuous RMS power output

110 + 110 watts
(6 ohms at 1 kHz,
10% THD)

The following measured at AC 120, 220, 240 V, 50/
60 Hz

DIN power output (rated)

100 + 100 watts
(6 ohms at 1 kHz, DIN)

Continuous RMS power output (reference)

120 + 120 watts
(6 ohms at 1 kHz,
10% THD)

Peak music power output 2000 watts

Inputs

MD/VIDEO 1 IN (phono
jacks): voltage 450/250
mV, impedance 47
kilohms

AV INPUT AUDIO

(phono jacks):
voltage 250 mV,
impedance 47 kilohms
MIX MIC (phono jack):
sensitivity 1 mV,
impedance 10 kilohms

Outputs

MD/VIDEO 1 OUT
(phono jacks): voltage
450/250 mV, impedance
1 kilohm
PHONES (stereo phone
jack): accepts headphones
of 8 ohms or more.
FRONT SPEAKER:
accepts impedance of 6 to
16 ohms
REAR SPEAKER: accepts
impedance of 16 ohms
SUPER WOOFER:
voltage 1 V, impedance
1 kilohm

Video section

Inputs

AV INPUT VIDEO
(phono jack):

1 V_{p-p}, 75 ohms

Outputs

MONITOR OUT

(phono jack):
1 V_{p-p}, 75 ohms

CD player section

System

Compact disc and digital
audio system

Laser

Semiconductor laser
($\lambda=780\text{nm}$)

Emission duration:
continuous

Laser output

Max. 44.6 μW^*

*This output is the value
measured at a distance of
200 mm from the
objective lens surface on
the Optical Pick-up Block
with 7 mm aperture.

Frequency response

20 Hz - 20 kHz (± 1 dB)

Wavelength

780 - 790 nm

Signal-to-noise ratio

More than 90 dB

Dynamic range

More than 90 dB

CD OPTICAL DIGITAL OUT

(Square optical connector jack, rear panel)

Wavelength

600 nm

Output Level

-18 dBm

Tape player section

Recording system

4-track 2-channel stereo

Frequency response

40 - 13,000 Hz (± 3 dB),

(DOLBY NR OFF)

using Sony TYPE I
cassette

40 - 14,000 Hz (± 3 dB),

using Sony TYPE II

cassette

Wow and flutter

$\pm 0.15\%$ W.Peak (IEC)

0.1% W.RMS (NAB)

$\pm 0.2\%$ W.Peak (DIN)

Tuner section

FM stereo, FM/AM superheterodyne tuner

FM tuner section

Tuning range 87.5 – 108.0 MHz
Antenna FM lead antenna
Antenna terminals 75 ohm unbalanced
Intermediate frequency 10.7 MHz

AM tuner section

Tuning range MW:
531 – 1,602 kHz
(with the MW tuning interval set at 9 kHz)
530 – 1,710 kHz
(with the MW tuning interval set at 10 kHz)
SW:
5.95 – 17.90 MHz
(with the SW tuning interval set at 5 kHz)
Intermediate frequency 450 kHz
Antenna AM loop antenna
External antenna terminal

Speaker

SS-W777G

Speaker system 4-way, 5-unit,
bass-reflex type,
magnetically shielded
type
Speaker units
Woofer: 20 cm dia., cone type
Center Tweeter: 3 cm dia., dome type
Side Tweeter: 5 cm dia., cone type x 2
Super Tweeter: 2 cm dia., dome type
Nominal impedance 6 ohms
Dimensions (w/h/d) Approx. 227 x 410 x 340
mm
Mass Approx. 6.5 kg net per
speaker

General

Power requirements 120 V , 220 V or 230 -
240 V AC, 50/60 Hz
Adjustable with voltage
selector
Power consumption 240 watts
Dimensions (w/h/d) STR-W555
Approx. 288x 205 x 375
mm
HTC-W555
Approx. 288 x 205 x 360
mm
Mass STR-W555 : Approx. 7.8
kg
HTC-W555 : Approx. 4.4
kg
Supplied accessories:
AM loop antenna (1)
Remote RM-SR5 (1)
Size AA (R6) batteries (2)
FM lead antenna (1)
Speaker cords (2)
Speaker pads (8)

Design and specifications are subject to change
without notice.

Index

A

- Adjusting
 - the audio emphasis 29
 - the sound 27
 - the volume 12, 14, 16
- Antennas 5, 10
- Automatic Source Selection 12, 14, 17
- Automatic sliding sensor 5

B

- Batteries 5

C

- CD player 11, 19
- CD Synchro Recording 13
- Clock setting 6
- Connecting. *See* Hooking up

D

- Display 5, 19, 28

E

- Edit 25, 39

F, G

- Flash 26

H, I, J

- Hooking up
 - optional components 8
 - optional speakers 8, 9
 - the antennas 5, 10
 - the power 5
 - the system 4

K

- Karaoke 32

L, M

- Loop 26

N

- Non-Stop Play 22
- Normal Play 11

O

- One Touch Play 12, 14, 17

P, Q

- Personal file 30
- Playing
 - a CD 11
 - a preset radio station 14
 - a tape 16
 - tracks in random order (Shuffle Play) 20
 - tracks in the desired order (Program Play) 21
 - tracks repeatedly (Repeat Play) 19
 - without interruption (Non-Stop Play) 22
- Presetting radio stations 7
- Preset tuning 14
- Program Play 21
- Protecting recordings 36

R

- Radio stations
 - presetting 7
 - tuning in 14
- Recording
 - a CD 13
 - a radio program 15
 - timer recording 35
- Repeat Play 19
- Resetting the system 39

S

- Saving recordings 36
- Selecting the audio emphasis 28
- Setting the time 6
- Shuffle Play 20
- Sleep Timer 33
- Sound adjustment 27
- Speakers 4, 9

T, U, V

- Timer
 - falling asleep to music 33
 - timer recording 35
 - waking up to music 34
- Troubleshooting 37
- Tuner 7, 14
- Tuning interval 7, 41

W, X, Y, Z

- Wake-up timer 34

