

Compact Hi-Fi Stereo System

Operating Instructions

Owner's Record

The model and serial numbers are located on the rear panel. Record the serial number in the space provided below. Refer to them whenever you call upon your Sony dealer regarding this product.

Model No. _____ Serial No. _____



*LBT-G2500 / LBT-XB20
LBT-XB22*

WARNING

To prevent fire or shock hazard, do not expose the unit to rain or moisture.

To avoid electrical shock, do not open the cabinet. Refer servicing to qualified personnel only.

Do not install the appliance in a confined space, such as a bookcase or built-in cabinet.

Laser component in this product is capable of emitting radiation exceeding the limit for Class 1.

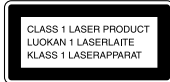

This appliance is classified as a CLASS 1 LASER product. The CLASS 1 LASER PRODUCT MARKING is located on the rear exterior.

This caution label is located inside the unit.



NOTICE FOR THE CUSTOMERS IN THE U.S.A.

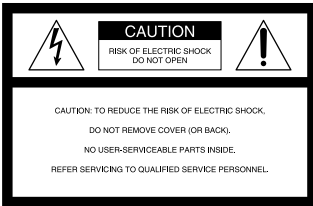

This symbol is intended to alert the user to the presence of uninsulated “dangerous voltage” within the product’s enclosure that may be of sufficient magnitude to constitute a risk of electric shock to persons.



This symbol is intended to alert the user to the presence of important operating and maintenance (servicing) instructions in the literature accompanying the appliance.

CAUTION

The use of optical instruments with this product will increase eye hazard.

INFORMATION

This equipment has been tested and found to comply with the limits for a Class B digital device, pursuant to Part 15 of the FCC Rules. These limits are designed to provide reasonable protection against harmful interference in a residential installation. This equipment generates, uses, and can radiate radio frequency energy and, if not installed and used in accordance with the instructions, may cause harmful interference to radio communications. However, there is no guarantee that interference will not occur in a particular installation. If this equipment does cause harmful interference to radio or television reception, which can be determined by turning the equipment off and on, the user is encouraged to try to correct the interference by one or more of the following measures:

- Reorient or relocate the receiving antenna.
- Increase the separation between the equipment and receiver.
- Connect the equipment into an outlet on a circuit different from that to which the receiver is connected.
- Consult the dealer or an experienced radio/TV technician for help.

CAUTION

You are cautioned that any changes or modifications not expressly approved in this manual could void your authority to operate this equipment.

Note on CATV system installer:

This reminder is provided to call CATV system installer’s attention to Article 820–40 of the NEC that provides guidelines for proper grounding and, in particular, specifies that the cable ground shall be connected to the grounding system of the building, as close to the point of cable entry as practical.

This stereo system is equipped with the Dolby® B-type noise reduction system.

* Dolby noise reduction manufactured under license from Dolby Laboratories Licensing Corporation. “DOLBY” and the double-D symbol  are trademarks of Dolby Laboratories Licensing Corporation.



(LBT-XB20 only)

Table of Contents

Getting Started

Step 1: Hooking up the system	4
Step 2: Setting the time	6
Step 3: Presetting radio stations	7
Connecting optional AV components	8
Connecting outdoor antennas	9

Basic Operations

Playing a CD	10
Recording a CD	12
Listening to the radio	13
Recording from the radio	14
Playing a tape	16
Recording from a tape	18

The CD Player

Using the CD display	19
Playing the CD tracks repeatedly	19
Playing the CD tracks in random order	20
Programming the CD tracks	21

The Tape Deck

Recording CDs by specifying the track order	23
--	----

Sound Adjustment

Adjusting the sound	25
Selecting the audio emphasis	25
Activating the surround effect	26

Other Features

Falling asleep to music	27
Waking up to music	27

Additional Information

Precautions	29
Troubleshooting	30
Specifications	33
Index	35

Step 1: Hooking up the system

Follow steps **1** through **5** to hook up your system using the supplied cords and accessories.

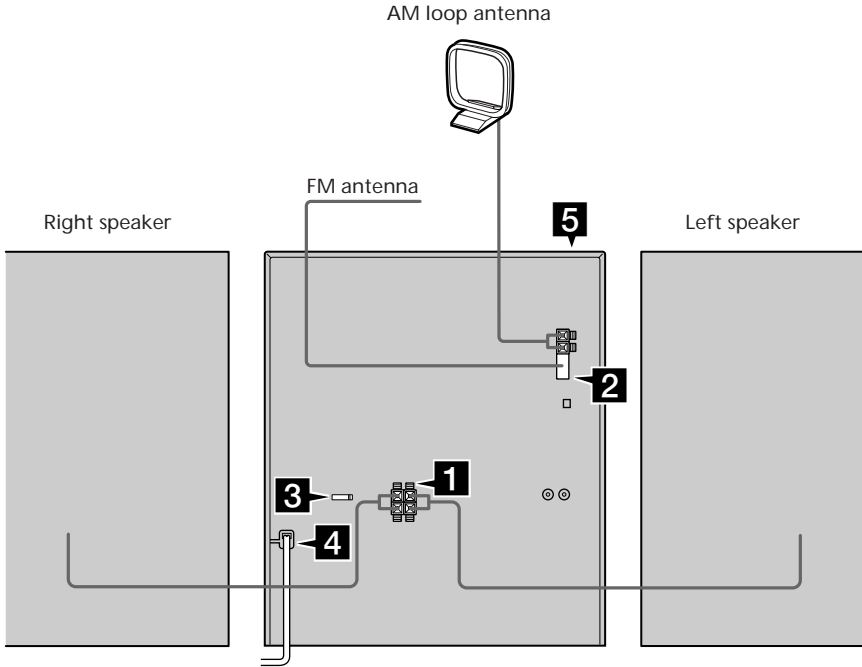

1 Connect the speakers.

- 1 Connect the speaker cords to SPEAKER jacks of the same color. Keep the speaker cords away from the antennas to prevent noise.

- 2 Insert only the stripped portion of the cord. Inserting the vinyl portion will interfere with the speaker connection and no sound will come from the speaker.

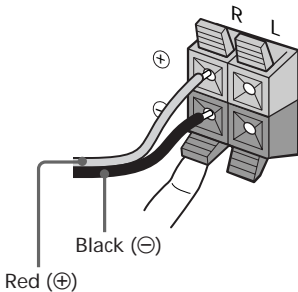

-
- 2** Connect the FM/AM antennas. Set up the AM loop antenna, then connect it.

Jack type ①

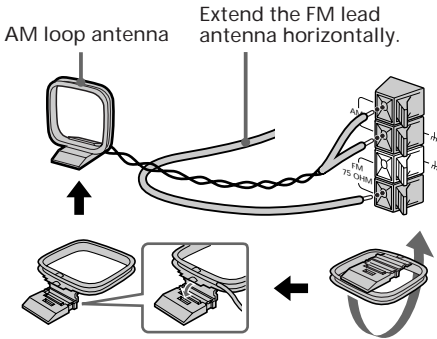

Jack type ②

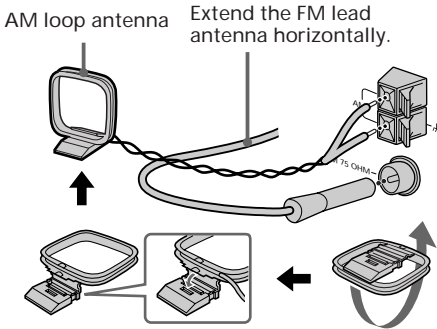

-
- 3** Set VOLTAGE SELECTOR to the position of your local power line voltage (for models with a voltage selector).

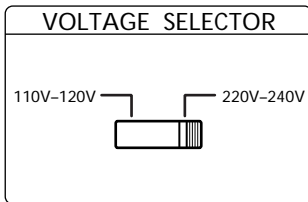

-
- 4** Connect the power cord to a wall outlet. The demonstration appears in the display.

-
- 5** Deactivate the demonstration mode by pressing DISPLAY/DEMO while the system is off. The demonstration mode is also deactivated when you set the time.

Inserting two size AAA (R03) batteries into the remote

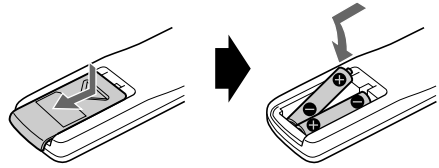

Tip

With normal use, the batteries should last for about six months. When the remote no longer operates the system, replace both batteries with new ones.

Note

If you do not use the remote for a long period of time, remove the batteries to avoid possible damage from battery leakage.

Step 2: Setting the time

You must set the time before using the timer functions.

You can set the time while the power is off.

For European models, the clock is on a 24-hour system.

For other models, the clock is on a 12-hour (AM/PM) system.

The 24-hour system model is used for illustration purpose.

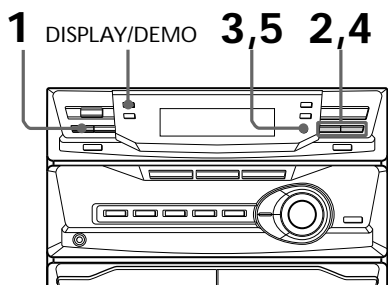

-
- 1 Press \ominus /CLOCK SET.
The hour indication flashes.



-
- 2 Press TUNING +/- to set the hour.



-
- 3 Press ENTER/NEXT.
The minutes indication flashes.



-
- 4 Press TUNING +/- to set the minutes.

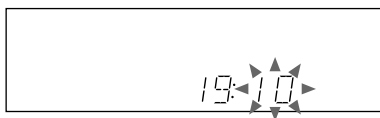

-
- 5 Press ENTER/NEXT.
The clock starts working.
-

To change the preset time

You can also change the time while the power is on.

- 1 Press \ominus /CLOCK SET.
- 2 Press TUNING +/- repeatedly until "SET CLOCK" appears, then press ENTER/NEXT.
- 3 Repeat steps 2 to 5 in "Setting the time".

Tips

- If you've made a mistake, start over from step 1.
- Setting the time deactivates the demonstration mode.

If you want to display the demonstration mode, press DISPLAY/DEMO when the power is off.

Step 3: Presetting radio stations

You can preset the following number of stations:

- 2 band model: 20 for FM and 10 for AM
- 3 band model: 20 for FM, 10 for MW, and 10 for LW

The band you can select depends on the kind of tuner built into your system. Confirm the bands by pressing TUNER/BAND repeatedly.

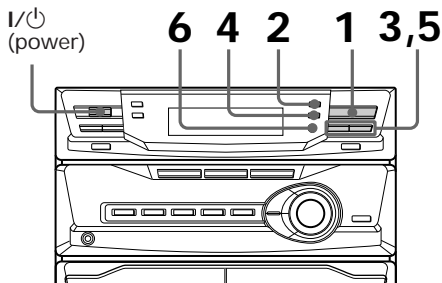

- 1** Press TUNER/BAND repeatedly until the band you want appears in the display.

Each time you press this button, the band changes as follows:

2 band model:

FM ↔ AM

3 band model:

FM → MW → LW



- 2** Press TUNING MODE repeatedly until “AUTO” appears in the display.

- 3** Press TUNING +/-.
The frequency indication changes and scanning stops when the system tunes in a station. “TUNED” and “STEREO” (for a stereo program) appear.

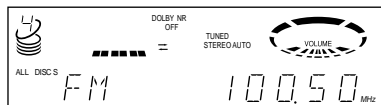

- 4** Press TUNER MEMORY.
A preset number flashes in the display.

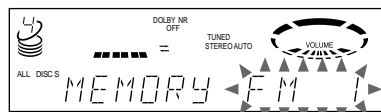

- 5** Press TUNING +/- to select the preset number you want.

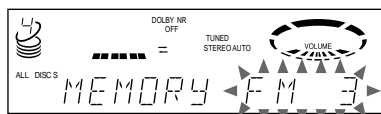

- 6** Press ENTER/NEXT.
The station is stored.

- 7** Repeat steps 1 through 6 to store other stations.

continued

Step 3: Presetting radio stations (continued)

To tune in a station with a weak signal

Press TUNING MODE repeatedly in step 2 until "MANUAL" appears, then press TUNING +/- to tune in the station manually.

To change the preset number

Start over from step 1.

To change the AM tuning interval (for models with the AM TUNING STEP switch on the rear panel)

The AM tuning interval is factory-preset to 9 kHz (10 kHz in some areas). To change the AM tuning interval, turn off the power and set the AM TUNING STEP switch on the rear panel to 10 kHz (or 9 kHz). Then turn the power back on. When you change the interval, all the preset stations will be erased.

Tip

The preset stations are retained for half a day even if you unplug the power cord or if a power failure occurs.

Connecting optional AV components

To enhance your system, you can connect optional components. Refer to the instructions included with each component for details.

Connecting a turntable

Be sure to match the color of the plugs and the connectors. To listen to the sound from the connected turntable, press PHONO.

To the audio output of the turntable

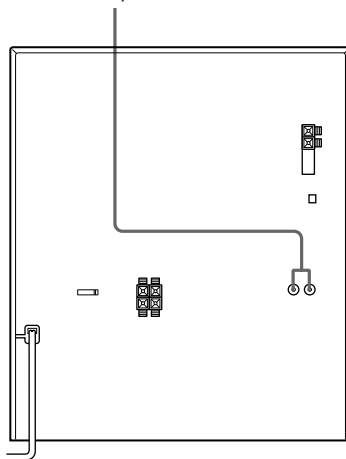

Note

Using the turntable at high volume may cause distortion or howling. This is often caused by the bass sound from the speakers. The bass sound may be picked up by the needle of the turntable, and produce the distortion or howling. To avoid this, do the following:

- 1 Keep some distance between the speakers and the turntable.
- 2 Stop using the surround effect.
- 3 Install the speakers or the turntable on a firm and stable surface.
- 4 Press DBFB repeatedly until "DBFB ■■■■■" disappears from the display.

Connecting outdoor antennas

Connect an outdoor antenna to improve the reception.

FM antenna

Connect an optional FM outdoor antenna. You can also use the TV antenna instead.

Jack type (A)

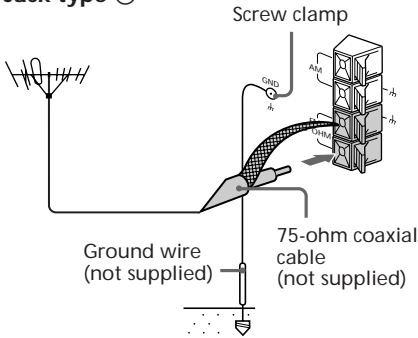

Jack type (B)

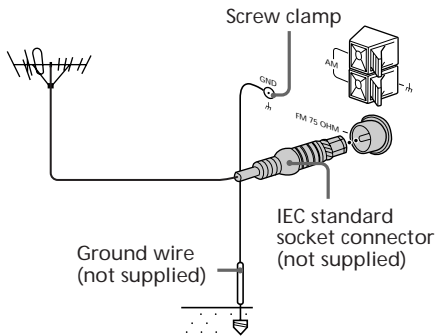

AM antenna

Connect a 6 to 15 meter (20 to 50 feet) insulated wire to the AM antenna terminal. Leave the supplied AM loop antenna connected.

Jack type (A)

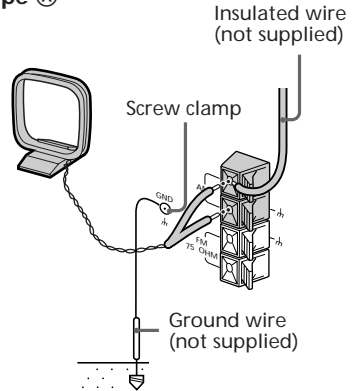

Jack type (B)

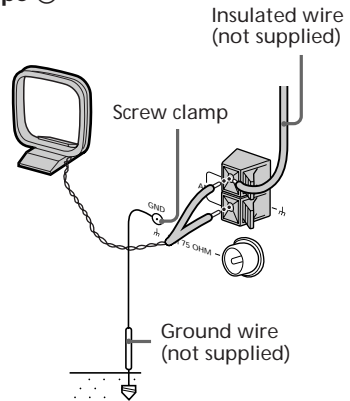

Important

If you connect an outdoor antenna, connect a ground wire to the GND terminal with the screw clamp. To prevent a gas explosion, do not connect the ground wire to a gas pipe.

Playing a CD

— Normal Play

You can play up to five CDs in a row.

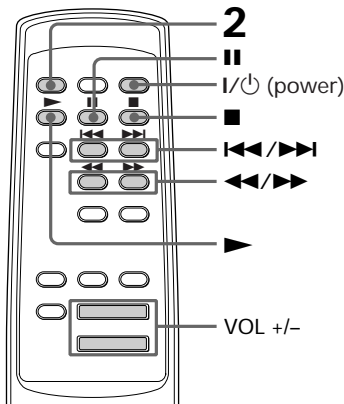
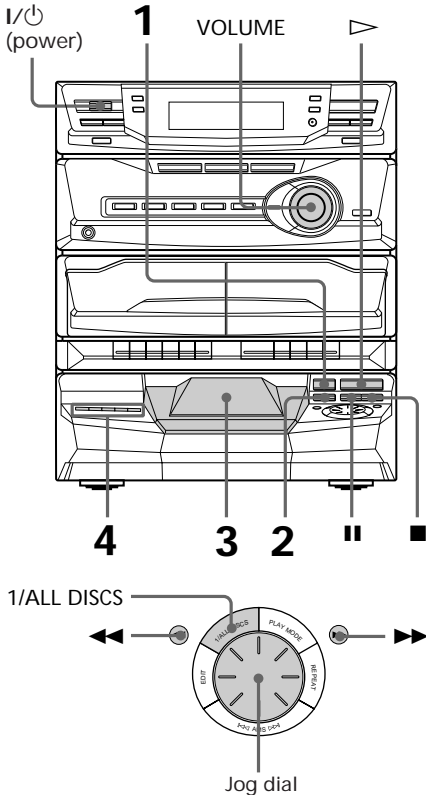

- 1 Press and place a CD on the disc tray.

If the disc is not placed properly, it will not be recognized.

With the label side up. When you play a CD single, place it on the inner circle of the tray.

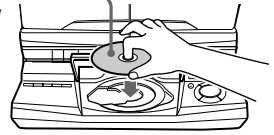

- 2 Press DISC SKIP to place up to four more CDs on the tray.

The disc tray rotates so you can insert other CDs.

- 3 Close the front cover.

- 4 Press one of the DIRECT PLAY buttons.

Play starts.

If you press (or on the remote), play starts from the CD in the playing position.

Disc number in the playing position

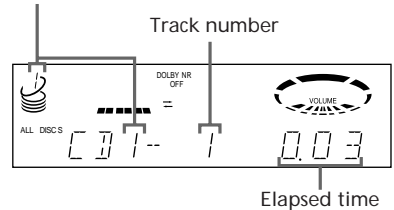

To	Do this
Stop play	Press ■.
Pause	Press ■■. Press again to resume play.
Go to the next track or go back to the start of the current track	During play or pause, turn the jog dial clockwise (to go forward) or counterclockwise (to go back). Or press ►► (to go forward) or ◄◄ (to go back) on the remote.
Find a point in a track	Press and hold down ►► or ◄◄ during play, and release it at the desired point.
Select a CD in stop mode	Press DISC SKIP.
Play only the CD you have selected	Press 1/ALL DISCS repeatedly until "1 DISC" appears.
Play all CDs	Press 1/ALL DISCS repeatedly until "ALL DISCS" appears.
Remove the CD	Press ⏏ in stop mode.
Exchange other CDs while playing	Press ⏏.
Adjust the volume	Turn VOLUME (or press VOL +/- on the remote).

Tips

- Pressing ▷ while the system power is off automatically turns on the system and starts CD playback if there is a CD on the tray (One Touch Play).
- You can switch from another source to the CD player and start playing a CD just by pressing ▷ or one of the DIRECT PLAY buttons (Automatic Source Selection).
- If there is no CD in the player, "NO DISC" appears in the display.
- You can change the CD in the loading position during play.

Recording a CD

You can use a TYPE I (normal) tape.

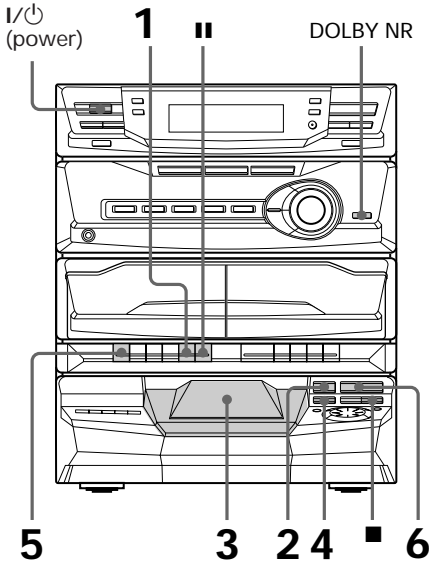

- 3 Close the front cover.
- 4 Press DISC SKIP repeatedly until the disc number you want to record appears in the playing position indicator.
- 5 Press ● on deck A. Recording starts.
- 6 Press ▷ on the CD player. The CD player starts playing.

To stop recording

Press ■ ▲ on deck A and then ■.

To pause recording

Press || on deck A.

Tip

When you want to reduce the hiss noise in low-level high-frequency signals, press DOLBY NR before step 5 so that "DOLBY NR B" appears in the display.

Note

You cannot listen to other sources while recording.

- 1 Press ■ ▲ and insert a blank tape into deck A.

With the side you want to record on facing forward

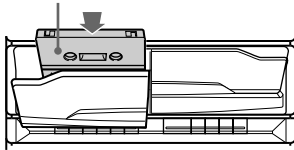

- 2 Press ⏪ and place a CD.

With the label side up. When you play a CD single, place it on the inner circle of the tray.

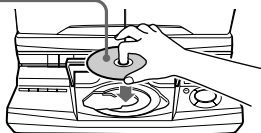

Listening to the radio

— Preset Tuning

Preset radio stations in the tuner's memory first (see "Step 3: Presetting radio stations").

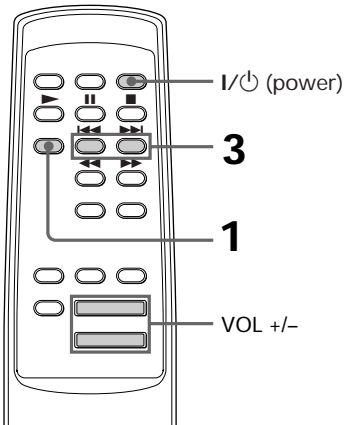
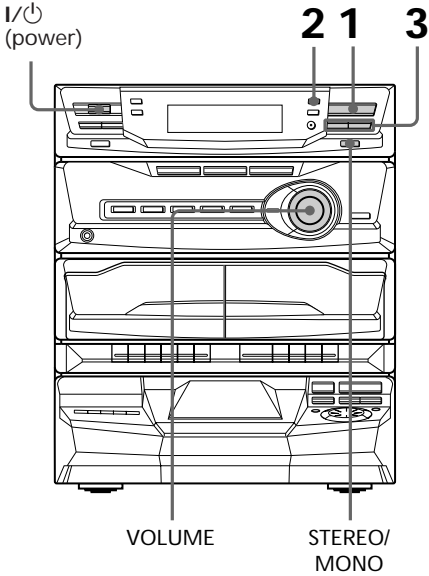

- 1 Press TUNER/BAND repeatedly until the band you want appears in the display.

Each time you press this button, the band changes as follows:

2 band model:

FM ↔ AM

3 band model:

FM → MW → LW



- 2 Press TUNING MODE repeatedly until "PRESET" appears.
MANUAL → AUTO → PRESET



- 3 Press TUNING +/- (or ◀◀ or ▶▶ on the remote) to tune in the desired preset station.
Press TUNING - (or ◀◀) for lower preset numbers.
Press TUNING + (or ▶▶) for higher preset numbers.

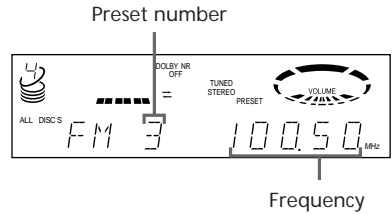

To	Do this
Turn off the radio	Press I/⏻ (power).
Adjust the volume	Turn VOLUME (or press VOL +/- on the remote).

continued

To listen to non-preset radio stations

Press TUNING MODE repeatedly in step 2 until "AUTO" or "MANUAL" appears, then press TUNING +/- to tune in the desired station.

Tips

- Pressing TUNER/BAND while the system power is off automatically turns on the system and tunes to the last received station (One Touch Play).
- You can switch from another source to the radio just by pressing TUNER/BAND (Automatic Source Selection).
- If an FM program is noisy, press STEREO/MONO so that "MONO" appears in the display. There will be no stereo effect, but the reception will improve. Press this button again to restore the stereo effect.
- To improve broadcast reception, move the supplied antennas.

Recording from the radio

You can record a radio program on a tape by tuning in a preset station. You can use a TYPE I (normal) tape.

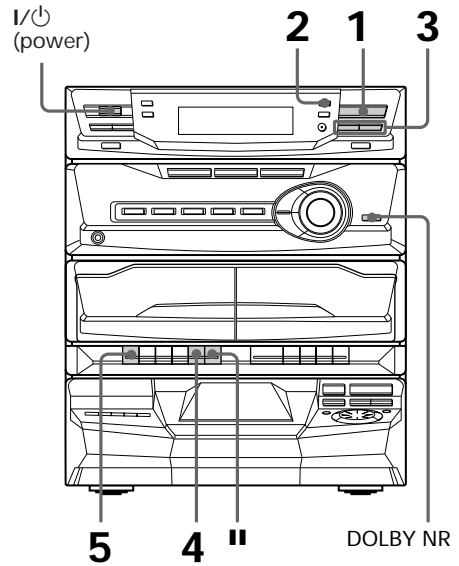

1 Press TUNER/BAND repeatedly until the band you want appears in the display.

2 Press TUNING MODE repeatedly until "PRESET" appears.

3 Press TUNING +/- (or ◀◀ or ▶▶ on the remote) to tune in a preset station.

Press TUNING - (or ◀◀) for lower preset numbers.
 Press TUNING + (or ▶▶) for higher preset numbers.

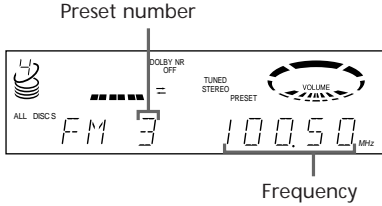

Tips

- To record non-preset stations, select “AUTO” or “MANUAL” in step 2, then press TUNING +/- to tune in the desired station.
- When you want to reduce the hiss noise in low-level high-frequency signals, press DOLBY NR before step 5 so that “DOLBY NR B” appears in the display.
- If noise is heard while recording from the radio, move the appropriate antenna to reduce the noise.

4 Press ■▲ and insert a blank tape into deck A.

With the side you want to record on facing forward

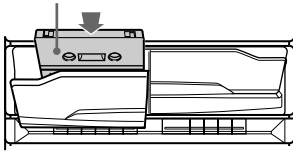

5 Press ● on deck A.
 Recording starts.

To stop recording

Press ■▲ on deck A.

To pause recording

Press || on deck A.

Playing a tape

You can play a TYPE I (normal) tape.

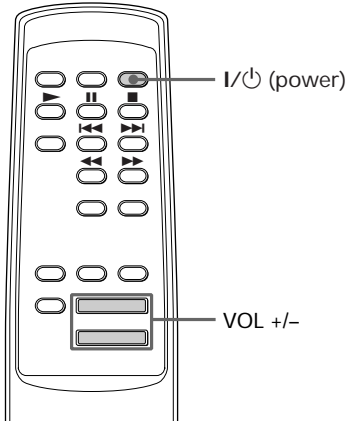
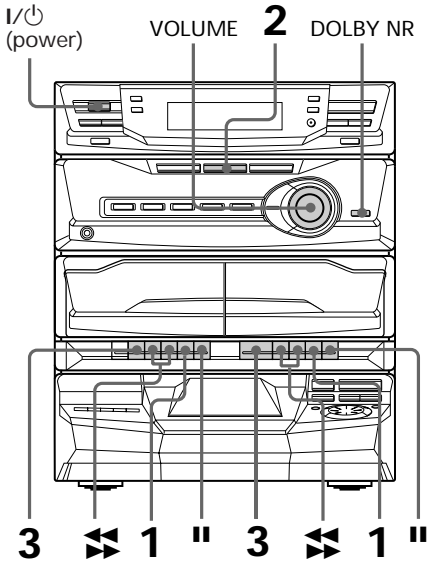

- 1 Press **■▲** and insert a recorded tape into deck A or B.

With the side you want to play facing forward

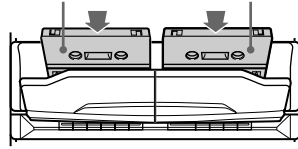





- 2 Press **TAPE**.
"TAPE" appears in the display.
- 3 Press **▶** on deck A or B.
The tape starts playing.

To	Do this
Stop play	Press ■▲ .
Pause	Press ⏸ . Press again to resume play.
Fast-forward	Press ⏭ .
Rewind	Press ⏮ .
Remove the cassette	Press ■▲ .
Adjust the volume	Turn VOLUME (or press VOL +/- on the remote).

To play both decks in succession (relay play)

You can listen to one side of the tapes in deck B and deck A in succession. When the tape in deck B finishes playing, the tape in deck A starts playing.

- 1 Press   and insert recorded tapes in both decks.
- 2 Press  on deck B.
- 3 Press  and  on deck A.

The tape on deck A is paused and automatically released when the playback on deck B ends.

Tips

- If you play both decks at the same time, you will hear the sound from deck B.
- When you want to reduce the hiss noise in low-level high-frequency signals, press DOLBY NR so that “DOLBY NR B” appears in the display.

Recording from a tape

You can use a TYPE I (normal) tape.

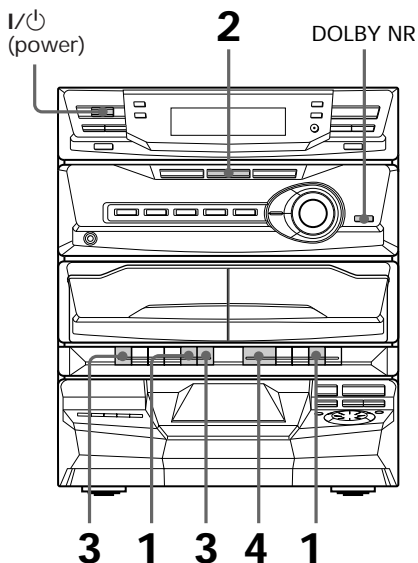

3 Press **⏸** and then **●** on deck A.
Deck A stands by for recording.

4 Press **▶** on deck B.
The tape starts dubbing.

To stop recording

Press **■ ▲** on deck A and deck B.

To pause recording

Press **⏸** on deck A.

Tip

When you want to reduce the hiss noise in low-level high-frequency signals, press DOLBY NR before step 3 so that "DOLBY NR B" appears in the display.

1 Press **■ ▲** and insert a recorded tape in deck B and a blank tape in deck A.

With the side you want to play/record on facing forward

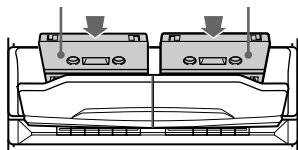

2 Press **TAPE**.
"TAPE" appears in the display.

Using the CD display

You can check the remaining time of the current track.

DISPLAY/DEMO

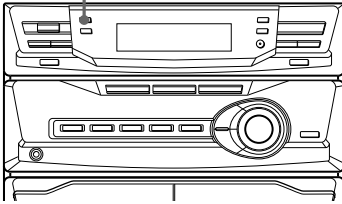

➔ Press DISPLAY/DEMO during playback.

Each time you press this button during normal play, the display changes as follows:

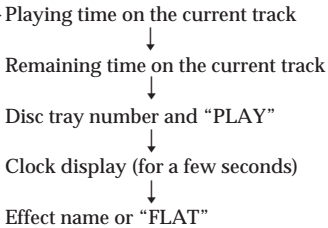

To check the total playing time and the number of tracks on a CD

Press DISPLAY/DEMO in stop mode.

If you press DISPLAY/DEMO again, the clock display appears for a few seconds then the display returns to the previous indication.

Playing the CD tracks repeatedly

— Repeat Play

This function lets you repeat a single CD or all CDs in normal play, Shuffle Play, and Program Play.

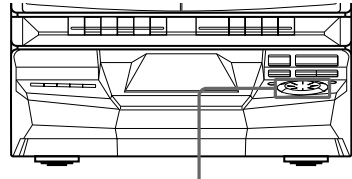

1/ALL DISCS

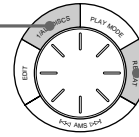

REPEAT

➔ Press REPEAT repeatedly during playback until "REPEAT" appears in the display.

Repeat Play starts. The following table describes the various repeat modes.

To repeat	Press
All the tracks on the current CD	1/ALL DISCS repeatedly until "1 DISC" appears in the display.
All the tracks on all CDs	1/ALL DISCS repeatedly until "ALL DISCS" appears in the display.
Only one track*	REPEAT repeatedly while playing the track you want to repeat until "REPEAT 1" appears in the display.

* You can't repeat a single track during Shuffle Play and Program Play.

To cancel Repeat Play

Press REPEAT repeatedly until "REPEAT" or "REPEAT 1" disappears from the display.

Playing the CD tracks in random order

— Shuffle Play

You can play all the tracks on one CD or all the CDs in random order.

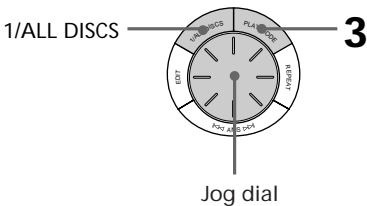
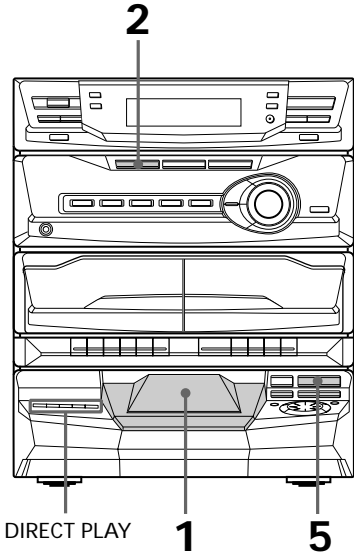

- 1** Place CDs and close the front cover.
- 2** Press CD.
“CD” appears in the display.
- 3** Press PLAY MODE repeatedly until “SHUFFLE” appears in the display.

- 4** Press 1/ALL DISCS to select “1 DISC” or “ALL DISCS.”
“ALL DISCS” shuffles the tracks on all the CDs in the player. “1 DISC” shuffles the tracks on the CD in the playing position.

- 5** Press \triangleright on the CD player.
“ \square ” appears and all the tracks play in random order.

To cancel Shuffle Play

Press PLAY MODE repeatedly until “SHUFFLE” or “PROGRAM” disappears from the display. The tracks continue playing in their original order.

To select a desired CD

Press one of the DIRECT PLAY buttons during 1 Disc Shuffle Play.

Tips

- You can start Shuffle Play during normal play by pressing PLAY MODE repeatedly until “SHUFFLE” appears in the display.
- To skip a track, turn the jog dial clockwise (or press \blacktriangleright on the remote).

Programming the CD tracks

— Program Play

You can create a program of up to 32 tracks from all the CDs in the order you want them to be played.

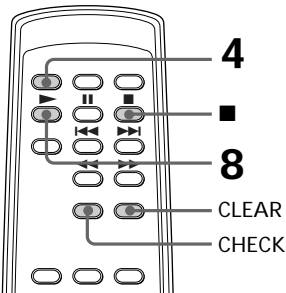
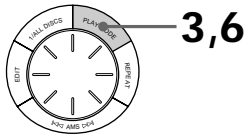
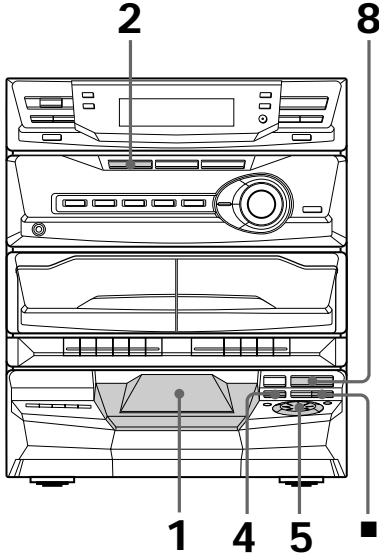

- 1 Place CDs and close the front cover.
- 2 Press CD.
"CD" appears in the display.
- 3 Press PLAY MODE repeatedly until "PROGRAM" appears in the display.
- 4 Press DISC SKIP repeatedly to select a CD.

- 5 Turn the jog dial until the desired track appears in the display.

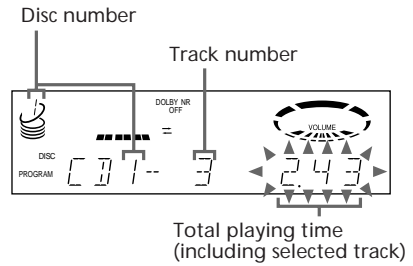

- 6 Press PLAY MODE once.
The track is programmed. The program step number appears, followed by the total playing time.

The last programmed track

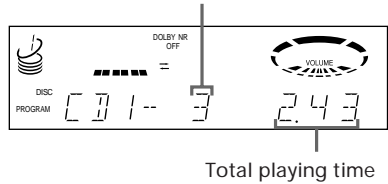

continued

Programming the CD tracks (continued)

7 To program additional tracks, repeat steps 4 through 6.
Skip step 4 to select tracks from the same disc.

8 Press \triangleright on the CD player.
All the tracks play in the order you selected.

To cancel Program Play

Press PLAY MODE repeatedly until "PROGRAM" or "SHUFFLE" disappears from the display.

To	Press
Check the program	CHECK on the remote repeatedly. After the last track, "CHECK END" appears.
Clear the last selected track	CLEAR on the remote in stop mode.
Clear a specific track	CHECK on the remote repeatedly until the number of the track to be cleared appears, then press CLEAR.
Add a track to the program	1 Press DISC SKIP to select a CD. 2 Turn the jog dial to select a track. 3 Press PLAY MODE.
Clear the entire program	■ once in stop mode or twice while playing.

Tips

- The program you created remains in the CD player's memory even after it has been played. Press \triangleright to play the same program again.
- If "--" appears instead of the total playing time while programming, this means:
 - you have programmed a track numbered over 20, or
 - the total playing time has exceeded 100 minutes.

Recording CDs by specifying the track order

— Program Edit

You can record tracks from all the CDs in the order you want. When programming, make sure the playing times for each side do not exceed the length of one side of the tape.

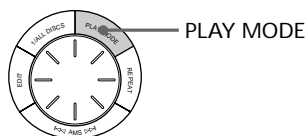
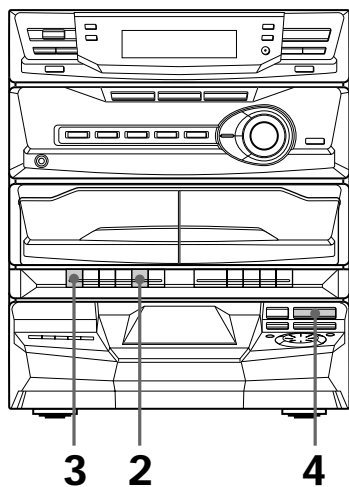

1 Follow steps 1 through 7 in “Programming the CD tracks” (see pages 21 and 22).

2 Press ■▲ and insert a blank tape into deck A.

3 Press ● on deck A.
Recording starts.

4 Press ▷ on the CD player.
The tracks play in the order you selected.

To stop recording

Press ■▲ on deck A.

To cancel Program Edit

Press PLAY MODE repeatedly until “PROGRAM” or “SHUFFLE” disappears from the display.

continued

Recording CDs by specifying the track order (continued)

Selecting the tape length automatically

— Tape Select Edit

You can check the most suitable tape length for recording a CD. Note that you cannot use Tape Select Edit for discs containing more than 20 tracks.

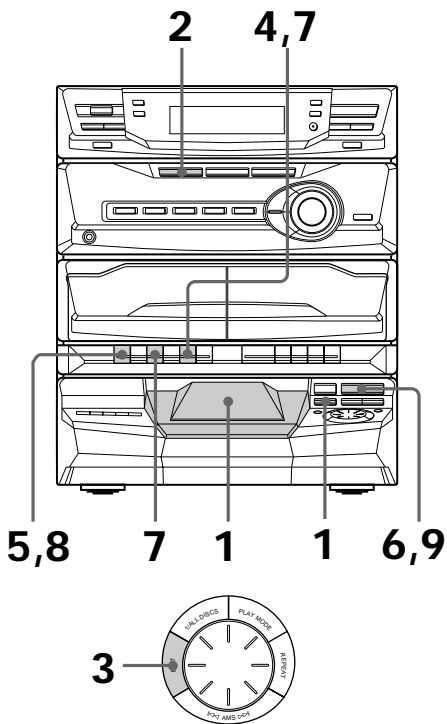

- 1 Place a CD on the disc tray.
If the disc number you want to record is not displayed, press DISC SKIP repeatedly so that it appears.

- 2 Press CD.
“CD” appears in the display.

- 3 Press EDIT once so that “EDIT” flashes.
The required tape length for the CD in the playing position appears, followed by the total playing time for sides A and B respectively.

- 4 Press and insert a blank tape into deck A.

- 5 Press on deck A.
Recording starts.

- 6 Press on the CD player.
The CD player starts playing the tracks to be recorded on side A.
When the last track for side A finishes playing, the CD player changes to playing pause automatically.

- 7 Press to remove the tape from deck A, and insert it again with the side B facing forward. Then press to rewind the tape completely.

- 8 Press on deck A.
Recording starts for side B.

- 9 Press on the CD player.
The CD player starts playing the tracks to be recorded on side B.

Note

You cannot use this function after programming. In order to use this function, you must first erase the program (see “Clear the entire program” in the table on page 22).

Adjusting the sound

You can reinforce the bass and listen with headphones.

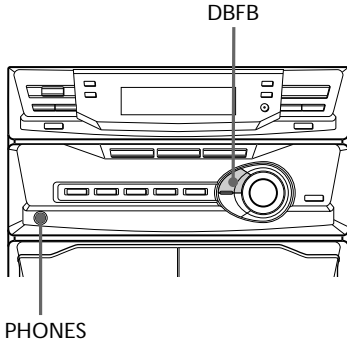

To reinforce the bass (DBFB)

Press DBFB.*

Each time you press this button, the DBFB level display changes as follows:

DBFB ■■■ → DBFB ■■■■■ → DBFB OFF

“DBFB ■■■■■” reinforces the bass more than “DBFB ■■■”.

* DBFB = Dynamic Bass Feedback

To listen through the headphones

Connect the headphones to the PHONES jack. No sound will come from the speakers.

Selecting the audio emphasis

The audio emphasis menu lets you select the sound characteristics according to the music you are listening to.

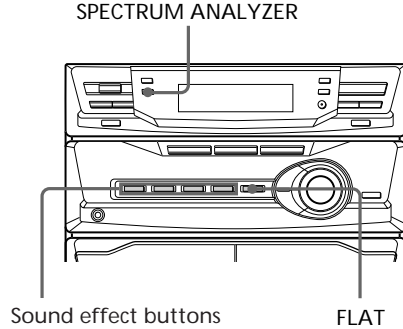

➔ Press one of the sound effect buttons (ROCK, POP, JAZZ or SALSA) you desire (or press FILE SELECT on the remote repeatedly until the indicator on the desired effect button lights up).

To cancel the audio emphasis

Press FLAT so that the indicator on the sound effect button goes off.

Tip

“SUR (|||||)” appears if you select an audio emphasis with a surround effect.

continued

Selecting the audio emphasis (continued)

To change the equalizer display

Each time you press SPECTRUM ANALYZER, the equalizer display changes to show one of the four displays below.

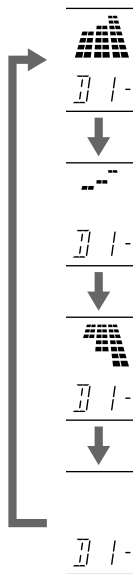

Activating the surround effect

You can enjoy the surround effect.

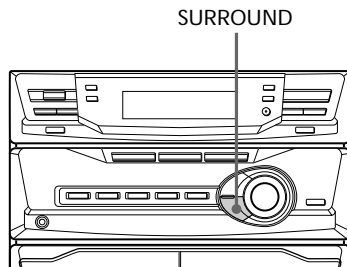

➔ Press SURROUND so that “SUR ((■■■■))” appears in the display.

Note

If you choose other sound effects, the surround effect will be canceled.

Waking up to music (continued)

-
- 4** Press TUNING +/- to select “DAILY 1”.

-
- 5** Press ENTER/NEXT.
“ON” appears and the hour indication flashes in the display.

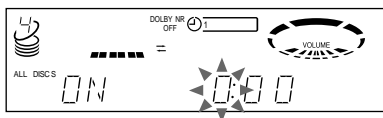

-
- 6** Set the time to start playback.
Press TUNING +/- to set the hour, then press ENTER/NEXT.
The minutes indication flashes.

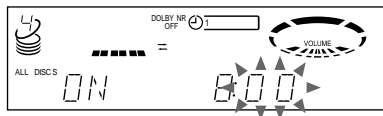

Press TUNING +/- to set the minutes, then press ENTER/NEXT.
“OFF” appears and the hour indication flashes again.

-
- 7** Set the time to stop playback following the above procedure.

-
- 8** Press TUNING +/- until the music source you want appears.
The indication changes as follows:
TUNER ↔ CD PLAY

-
- 9** Press ENTER/NEXT.
The start time, the stop time, and the music source appear in turn before the original display returns.

-
- 10** Turn off the system.

To check the setting

- 1** Press DAILY 1 so that “TIMER OFF” appears in the display.

- 2** Press DAILY 1 again.

To change the setting, start over from step 1.

To cancel the timer operation

Press DAILY 1 so that “TIMER OFF” appears in the display.

Tips

- The system turns on 15 seconds before the preset time.
- You cannot set the timer if the timer on and off times are the same.
- When you set the Sleep Timer, the Wake-up Timer will not turn on the system until the Sleep Timer turns it off.

Precautions

On operating voltage

Before operating the system, check that the operating voltage of your system is identical with the voltage of your local power supply.

On safety

- The unit is not disconnected from the AC power source (mains) as long as it is connected to the wall outlet, even if the unit itself has been turned off.
- Unplug the system from the wall outlet (mains) if it is not to be used for an extended period of time. To disconnect the cord (mains lead), pull it out by the plug. Never pull the cord itself.
- Should any solid object or liquid fall into the component, unplug the stereo system and have the component checked by qualified personnel before operating it any further.
- The AC power cord must be changed only at the qualified service shop.

On placement

- Place the stereo system in a location with adequate ventilation to prevent heat build-up in the stereo system.
- Do not place the unit in an inclined position.
- Do not place the unit in locations where it is;
 - Extremely hot or cold
 - Dusty or dirty
 - Very humid
 - Vibrating
 - Subject to direct sunlight

On operation

- If the stereo system is brought directly from a cold to a warm location, or is placed in a very damp room, moisture may condense on the lens inside the CD player. Should this occur, the system will not operate properly. Remove the CD and leave the system turned on for about an hour until the moisture evaporates.
- When you move the system, take out any discs.

If you have any questions or problems concerning your stereo system, please consult your nearest Sony dealer.

Notes on CDs

- Before playing, clean the CD with a cleaning cloth. Wipe the CD from the center out.
- Do not use solvents such as benzene, thinner, commercially available cleaners or anti-static spray intended for vinyl LPs.
- Do not expose the CD to direct sunlight or heat sources such as hot air ducts, nor leave it in a car parked in direct sunlight.

Cleaning the cabinet

Use a soft cloth slightly moistened with mild detergent solution.

To save a tape permanently

To prevent a tape from being accidentally recorded over, break off the cassette tab from side A or B as illustrated.

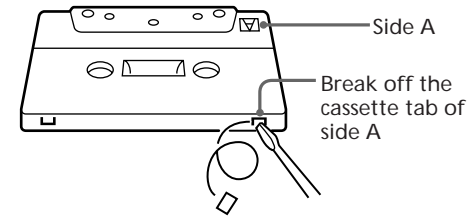
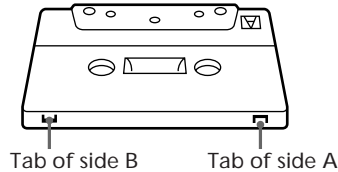

If you later want to reuse the tape for recording, cover the broken tab with adhesive tape.

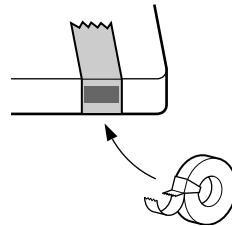

continued

Precautions (continued)

Before placing a cassette in the tape deck

Take up any slack in the tape. Otherwise the tape may get entangled in the parts of the tape deck and become damaged.

When using a tape longer than 90 minutes

The tape is very elastic. Do not change the tape operations such as play, stop, and fast-winding etc. frequently. The tape may get entangled in the tape deck.

Cleaning the tape heads

Clean the tape heads after every 10 hours of use.

When the tape heads become dirty

- the sound is distorted
- there is a decrease in sound level
- the sound drops out
- the tape does not erase completely
- the tape does not record

Make sure to clean the tape heads before you start an important recording or after playing an old tape. Use separately sold dry-type or wet-type cleaning cassette. For details, refer to the instructions of the cleaning cassette.

Demagnetizing the tape heads

Demagnetize the tape heads and the metal parts that have contact with the tape every 20 to 30 hours of use with a separately sold demagnetizing cassette. For details, refer to the instructions of the demagnetizing cassette.

Troubleshooting

If you run into any problem using this stereo system, use the following checklist.

First, check that the power cord is connected firmly and the speakers are connected correctly and firmly.

Should any problem persist, consult your nearest Sony dealer.

General

The display starts flashing as soon as you plug in the power cord even though you haven't turned on the system (demonstration mode).

- Press DISPLAY/DEMO while the system is off.

The demonstration appears automatically the first time you plug in the power cord, or if there is a power outage lasting longer than half a day.

In this case, reset the following:

- Clock setting (see "Step 2: Setting the time")
- Preset stations (see "Step 3: Presetting radio stations")
- Timer settings (see "Waking up to music")

There is no sound.

- Turn VOLUME clockwise.
- The headphones are connected.
- Insert only the stripped portion of the speaker cord into the SPEAKER jack. Inserting the vinyl portion of the speaker cord will interfere with the speaker connection.

There is severe hum or noise.

- A TV or VCR is placed too close to the stereo system. Move the stereo system away from the TV or VCR.

"0:00" (or "12:00AM") flashes in the display.

- A power failure occurred. Reset the clock and timer settings.

The timer does not function.

- Set the clock correctly.

"DAILY 1" does not appear when you press /CLOCK SET.

- Set the timer correctly.
- Set the clock.

The remote does not function.

- There is an obstacle between the remote and the unit.
- The remote is not pointing in the direction of the system's sensor.
- The batteries have run down. Replace the batteries.

There is acoustic feedback.

- Decrease the volume level.

The color irregularity on a TV screen persists.

- Place the speakers farther away from the TV set.
-

Speakers

Sound comes from only one channel or the left and right volumes are unbalanced.

- Check the speaker connections and placement.
-

CD Player

The CD tray does not rotate.

- A CD is not placed properly.
-

A CD will not play.

- The CD is not lying flat in the disc tray.
 - The CD is dirty.
 - The CD is inserted label side down.
 - Moisture condensation has built up. Remove the CD and leave the system turned on for about an hour until the moisture evaporates.
-

Play does not start from the first track.

- The player is in Program or Shuffle Play mode. Press PLAY MODE repeatedly until "PROGRAM" or "SHUFFLE" disappears from the display.
-

"OVER" is displayed.

- You have reached the end of the CD. Press and hold  to return.
-

continued

Troubleshooting (continued)

Tape Deck

The tape does not record.

- No tape is in the cassette holder.
- The tab has been removed from the cassette (see page 29).
- The tape has reeled to the end.

The tape does not record nor play, or there is a decrease in sound level.

- The heads are dirty. Clean them (see page 30).
- The record/playback heads are magnetized. Demagnetize them (see page 30).

The tape does not erase completely.

- The record/playback heads are magnetized. Demagnetize them (see page 30).

There is excessive wow or flutter, or the sound drops out.

- The capstans or pinch rollers are dirty. Clean them (see page 30).

Noise increases or the high frequencies are missing.

- The record/playback heads are magnetized. Demagnetize them (see page 30).
-

Tuner

Severe hum or noise ("TUNED" or "STEREO" flashes in the display).

- Adjust the antenna.
- The signal strength is too weak. Connect an external antenna.

A stereo FM program cannot be received in stereo.

- Press STEREO/MONO so that "STEREO" appears in the display.
-

If other problems not described above occur, reset the system as follows:

- 1 Unplug the power cord.
- 2 Plug the power cord back in.

Specifications

AUDIO POWER SPECIFICATIONS: (U.S.A. model only)

POWER OUTPUT AND TOTAL HARMONIC DISTORTION:

With 6 ohm loads, both channels driven, from 70 – 20,000 Hz; rated 60 watts per channel minimum RMS power, with no more than 0.9% total harmonic distortion from 250 milliwatts to rated output.

Amplifier section

North American model

Continuous RMS power output
70 watts + 70 watts
(6 ohms at 1 kHz,
10% THD)

Total harmonic distortion
less than 0.09%
(6 ohms at 1 kHz,
30 watts)

European model

DIN power output (Rated)
60 watts + 60 watts
(6 ohms at 1 kHz, DIN)

Continuous RMS power output (Reference)
70 watts + 70 watts
(6 ohms at 1 kHz,
10% THD)

Music power output (Reference)
120 watts + 120 watts
(6 ohms at 1 kHz,
10% THD)

Other models

The following measured at AC 110, 220 V 60 Hz;
DIN power output (Rated)

45 watts + 45 watts
(6 ohms at 1 kHz, DIN)

Continuous RMS power output (Reference)
55 watts + 55 watts
(6 ohms at 1 kHz,
10% THD)

The following measured at AC 120, 240 V 60 Hz;
DIN power output (Rated)

50 watts + 50 watts
(6 ohms at 1 kHz, DIN)

Continuous RMS power output (Reference)
60 watts + 60 watts
(6 ohms at 1 kHz,
10% THD)

Peak music power output (Reference)
800 watts

Inputs

PHONO IN (phono jacks):
sensitivity 3 mV,
impedance 47 kilohms

Outputs

PHONES (stereo phone jack):
accepts headphones of
8 ohms or more

SPEAKER:
accepts impedance of 6 to
16 ohms

CD player section

System
Compact disc and digital
audio system

Laser
Semiconductor laser
($\lambda = 780 \text{ nm}$)
Emission duration:
continuous

Laser output
Max. 44.6 μW *
* This output is the value
measured at a distance of
200 mm from the
objective lens surface on
the Optical Pick-up Block
with 7 mm aperture.

Frequency response
Wavelength
20 Hz – 20 kHz ($\pm 0.5 \text{ dB}$)
780 – 790 nm

Tape deck section

Recording system
Frequency response
(DOLBY NR OFF)
4-track 2-channel stereo
60 – 13,000 Hz ($\pm 3 \text{ dB}$),
using a Sony TYPE I
cassette

Wow and flutter
 $\pm 0.15\% \text{ W. Peak (IEC)}$
 $0.1\% \text{ W. RMS (NAB)}$
 $\pm 0.2\% \text{ W. Peak (DIN)}$

continued

Specifications (continued)

Tuner section

FM stereo, FM/AM superheterodyne tuner

FM tuner section

Tuning range 87.5 – 108.0 MHz
Antenna FM lead antenna
Antenna terminals 75 ohm unbalanced
Intermediate frequency 10.7 MHz

AM tuner section

Tuning range
(2 band model)
North American model:
530 – 1,710 kHz
(with the tuning interval
set at 10 kHz)
Other models:
531 – 1,602 kHz
(with the tuning interval
set at 9 kHz)
530 – 1,710 kHz
(with the tuning interval
set at 10 kHz)
(3 band model)
MW: 531 – 1,602 kHz
(with the tuning interval
set at 9 kHz)
LW: 153 – 279 kHz
(with the tuning interval
set at 3 kHz)
Antenna AM loop antenna
Antenna terminals External antenna terminal
Intermediate frequency 450 kHz

Speakers

Speaker system 2-way, bass-reflex type
Speaker units
Woofer: 17 cm dia., cone type
Tweeter: 5 cm dia., cone type
Nominal impedance 6 ohms
Dimensions (w/h/d) Approx. 245 × 423 × 298 mm
(9^{3/4} × 16^{3/4} × 11^{3/4} in)
Mass Approx. 5.4 kg (11 lb
14 oz.) net per speaker

General

Power requirements
North American model: 120 V AC, 60 Hz
Mexican model: 120 V AC, 50/60 Hz
European model: 230 V AC, 50/60 Hz
Australian, South African and Thailand models: 220 – 240 V AC, 50/60 Hz
Other models: 110 – 120 V AC or 220 – 240 V AC, 50/60 Hz (adjustable with voltage selector)
Power consumption 130 watts
Dimensions (w/h/d) incl. projecting parts and controls Approx. 355 × 423 × 440 mm
(14 × 16^{3/4} × 17^{3/8} in)
Mass Approx. 14.0 kg (30 lb 14 oz.)
Supplied accessories AM loop antenna (1)
Remote RM-SG5 (1)
FM lead antenna (1)

Design and specifications are subject to change without notice.

Index

A

- Adjusting
 - the sound 25
 - the volume 10, 13, 16
- Antennas 5, 9
- Audio emphasis 25
- Automatic Source Selection 11, 14

B

- Batteries 5

C

- CD player 10, 12, 19
- Clock setting 6
- Connecting. *See* Hooking up

D

- Display 6, 7, 10, 19
- Dolby Noise Reduction 2, 15
- Dubbing 18

E, F, G

- Edit 23, 24

H, I, J, K, L, M

- Hooking up
 - optional components 8
 - the antennas 5, 9
 - the power 5
 - the system 4

N

- Normal Play 10

O

- One Touch Play 11, 14

P, Q

- Playing
 - a CD 10
 - a preset radio station 13
 - a tape 16
 - tracks in random order (Shuffle Play) 20
 - tracks in the desired order (Program Play) 21
 - tracks repeatedly (Repeat Play) 19
- Precautions 29
- Presetting radio stations 7
- Preset tuning 13
- Program Edit 23
- Program Play 21
- Protecting recordings 29

R

- Radio stations
 - presetting 7
 - tuning in 13
- Recording
 - a CD 12
 - a radio program 14
 - a tape 18
 - CDs by specifying the track order 23
 - selecting tape length automatically 24
- Relay Play 17
- Repeat Play 19
- Resetting the system 32

S

- Saving recordings 29
- Selecting the audio emphasis 25
- Setting the time 6
- Shuffle Play 20
- Sleep Timer 27
- Sound adjustment 25
- Speakers 4
- Surround effect 26

T, U, V

- Tape Select Edit 24
- Timer
 - falling asleep to music 27
 - waking up to music 27
- Troubleshooting 30
- Tuner 7, 13, 14
- Tuning interval 8, 34
- Turntable 8

W, X, Y, Z

- Wake-up timer 27

