

Compact Disc Player

Operating Instructions



CDP-CA80ES

WARNING

To prevent fire or shock hazard, do not expose the unit to rain or moisture.

To avoid electrical shock, do not open the cabinet. Refer servicing to qualified personnel only.

For the customers in the United States

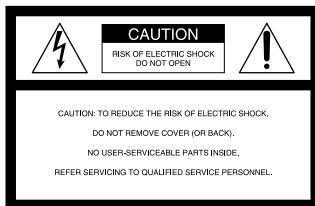

This symbol is intended to alert the user to the presence of uninsulated "dangerous voltage" within the product's enclosure that may be of sufficient magnitude to constitute a risk of electric shock to persons.



This symbol is intended to alert the user to the presence of important operating and maintenance (servicing) instructions in the literature accompanying the appliance.

INFORMATION

This equipment has been tested and found to comply with the limits for a Class B digital device, pursuant to Part 15 of the FCC Rules. These limits are designed to provide reasonable protection against harmful interference in a residential installation. This equipment generates, uses, and can radiate radio frequency energy and, if not installed and used in accordance with the instructions, may cause harmful interference to radio communications. However, there is no guarantee that interference will not occur in a particular installation. If this equipment does cause harmful interference to radio or television reception, which can be determined by turning the equipment off and on, the user is encouraged to try to correct the interference by one or more of the following measures:

- Reorient or relocate the receiving antenna.
- Increase the separation between the equipment and receiver.
- Connect the equipment into an outlet on a circuit different from that to which the receiver is connected.
- Consult the dealer or an experienced radio/TV technician for help.

CAUTION

You are cautioned that any changes or modification not expressly approved in this manual could void your authority to operate this equipment.

Owner's Record

The model and serial numbers are located at the rear of the unit.

Record the serial number in the space provided below. Refer to them whenever you call upon your Sony dealer regarding this product.

Model No. _____

Serial No. _____

For the customers in Europe and Australia

The following caution label is located inside the unit.



This appliance is classified as a CLASS 1 LASER product.

The CLASS 1 LASER PRODUCT MARKING is located on the rear exterior.

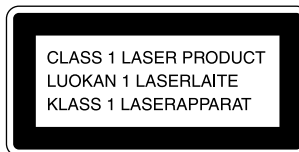

Welcome!

Thank you for purchasing the Sony Compact Disc Player. Before operating the unit, please read this manual thoroughly and retain it for future reference.

About This Manual

The instructions in this manual are for model CDP-CA80ES.

Conventions

- Instructions in this manual describe the controls on the player. You can also use the controls on the remote if they have the same or similar names as those on the player.
- The following icons are used in this manual:



Indicates that you can do the task using the remote.



Indicates hints and tips for making the task easier.

TABLE OF CONTENTS

Getting Started

Unpacking	4
Hooking Up the System	4

Playing a CD	6
--------------------	---

Playing CDs

Using the Display	8
Replacing Other Discs While Playing a Disc	10
Locating a Specific Disc	11
Locating a Specific Track	11
Locating a Particular Point in a Track	12
Playing Repeatedly	12
Playing in Random Order (Shuffle Play)	13
Creating Your Own Program (Program Play)	13

Recording From CDs

Recording Your Own Program	16
Fading In or Out	16

Storing Information About CDs (Custom Files)

What You Can Do With the Custom Files	17
Labeling Discs (Disc Memo)	17
Storing Specific Tracks (Delete Bank)	19

Additional Information

Precautions	20
Notes on CDs	20
Troubleshooting	21
Specifications	21

Index

Index	22
-------------	----

Unpacking

Check that you received the following items:

- Audio connecting cord (1)
- Remote commander (remote) (1)
- Size AA (R6) batteries (2)

Inserting batteries into the remote

You can control the player using the supplied remote. Insert two size AA (R6) batteries by matching the + and – ends on the batteries to the diagram inside the battery compartment. When using the remote, point it at the remote sensor  on the player.

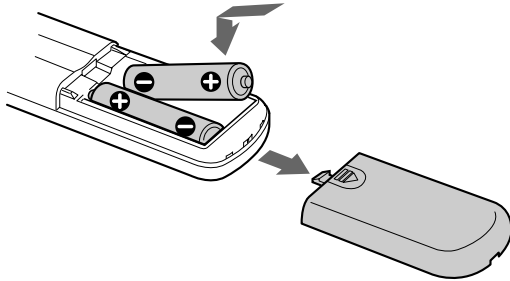

When to replace batteries

With normal use, the batteries should last for about six months. When the remote no longer operates the player, replace all the batteries with new ones.

Notes

- Do not leave the remote near an extremely hot or humid place.
- Do not drop any foreign object into the remote casing, particularly when replacing the batteries.
- Do not expose the remote sensor to direct sunlight or lighting apparatuses. Doing so may cause a malfunction.
- If you are not going to use the remote for an extended period of time, remove the batteries to avoid possible damage from battery leakage and corrosion.

Hooking Up the System

Overview

This section describes how to hook up the CD player to an amplifier. Be sure to turn off the power of each component before making the connections.

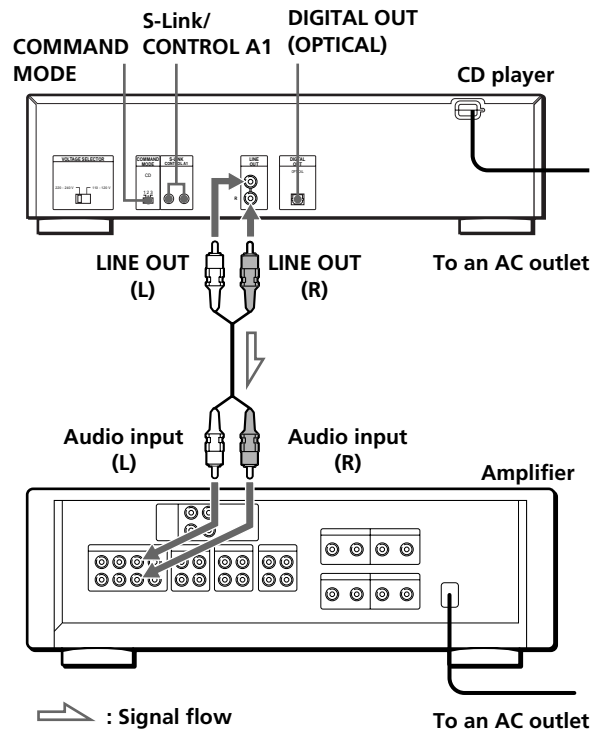

What cords will I need?

Audio cord (supplied) (1)

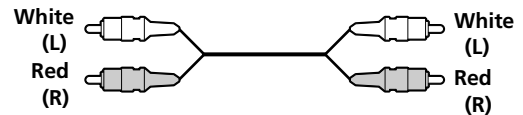

Hookups

When connecting an audio cord, be sure to match the color-coded cord to the appropriate jacks on the components: Red (right) to Red and White (left) to White. Be sure to make connections firmly to avoid hum and noise.

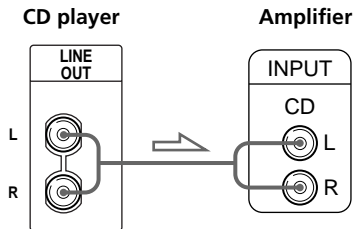

You can adjust the output level to the amplifier

Press LINE OUT LEVEL +/- on the remote. You can reduce the output level to -20 dB. When you reduce the output level, "FADE" appears in the display.

Note

If you press the LINE OUT LEVEL +/- buttons on the remote while recording, the recording level will change even when it is preset on the tape deck, etc.

• If you have a digital component such as a digital amplifier, D/A converter, DAT or MD

Connect the component via the DIGITAL OUT (OPTICAL) connector using the optical cable (not supplied). Take off the cap and plug in the optical cable. Note that you cannot use the fade in or out (page 16) functions when using this connection.

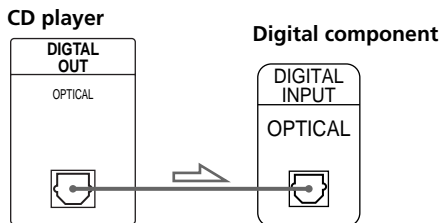
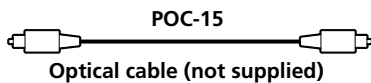

Note

When you connect via the DIGITAL OUT (OPTICAL) connector, noise may occur when you play CD software other than music, such as a CD-ROM.

If you have a Sony component with the CONTROL A1 jack

Connect the component via the CONTROL A1 jack. You can simplify the operation of audio systems composed of separate Sony components. For details, refer to the supplementary "S-Link™/CONTROL-A1 Control System" instructions.

When using another Sony CD player together with this player

You can make the supplied remote so that it is effective only for this player.

- When using a player equipped with the COMMAND MODE selector:
Set the command mode selector of this player to CD1 (Factory preset position) and that of another player to CD2 or CD3. Then set the CD 1/2/3 switch on the remote supplied for each player accordingly.
- When using a player not equipped with the COMMAND MODE selector:
The command mode of the player without the COMMAND MODE selector is set to CD 1. Set the COMMAND MODE selector of this player and the CD 1/2/3 switch on the remote to CD 2 or CD 3.

Setting the voltage selector (voltage selector equipped models only)

Check that the voltage selector on the rear panel of the player is set to the local power line voltage. If not, set the selector to the correct position using a screwdriver before connecting the AC power cord to a wall outlet.

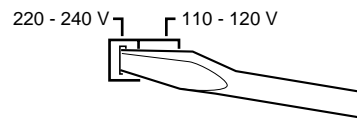

Connecting the AC power cord

Connect the AC power cord to a wall outlet.

Transporting the player

Before transporting the player, follow the procedure below to return the internal mechanisms back to their original position.

- 1 Remove all the discs from the disc tray.
- 2 Press OPEN/CLOSE to close the disc tray. "NO DISC" appears in the display.
- 3 Wait for 10 seconds, then press I/⏻ to turn off the player.

Playing a CD

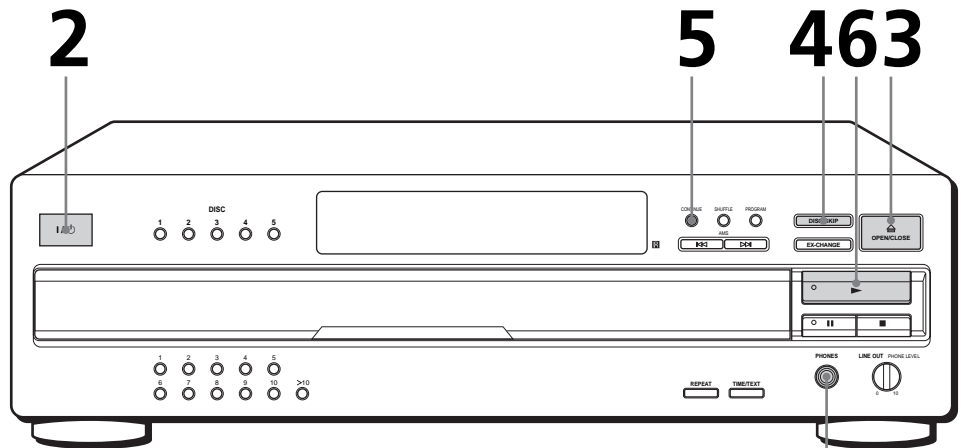

Connect the headphones.

- See pages 4 – 5 for the hookup information.

- 1 Turn on the amplifier and select the CD player position so that you can listen to the sound from this player.
- 2 Press I/⏻ to turn on the player.
- 3 Press ≡ OPEN/CLOSE, and place a disc on the disc tray.

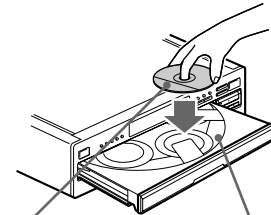

With the label side up

Disc number

- 4 To place other discs, press DISC SKIP and place the discs in the order you want to play.
Each time you press the button, the disc tray turns and you can place the discs in the empty disc compartments. The player plays the disc in the loading position first.
- 5 Press CONTINUE to select ALL DISCS or 1 DISC Continuous Play mode.
Each time you press the CONTINUE button, "ALL DISCS" or "1 DISC" appears in the display.

When you select	The player plays
ALL DISCS	All discs in the player consecutively in the order of disc number
1 DISC	Only the disc you have selected

💡 You can select the disc you want to start playing first
Press one of the DISC 1 – 5 buttons.

💡 You can adjust the output level to the amplifier 
Press LINE OUT LEVEL +/- on the remote. You can reduce the output level up to -20 dB.
When you reduce the output level, "FADE" appears in the display.
The headphones volume will also change when you adjust the output level.

Note





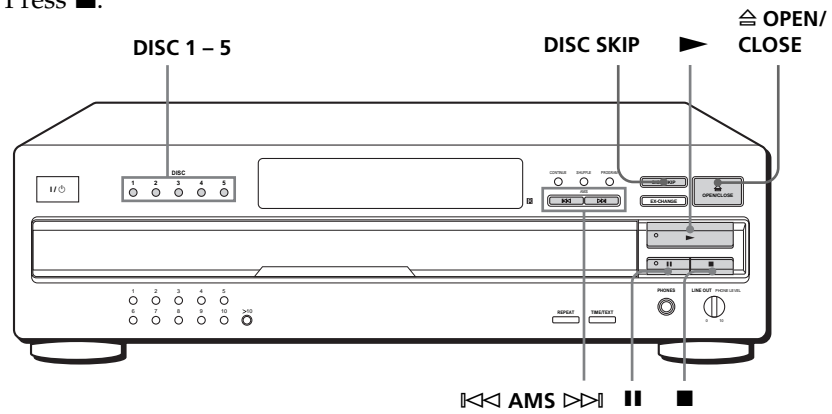

If you press the LINE OUT LEVEL +/- buttons on the remote while recording, the recording level will change even when it is preset on the tape deck, etc.

6 Press  (the indicator lights up green).
The disc tray closes and the player plays all the tracks once (Continuous Play). Adjust the volume on the amplifier.

To stop play

Press .



To	You need to
Pause	Press  (The indicator lights up orange.)
Resume play after pause	Press  or 
Go to the next track	Press 
Go back to the preceding track	Press 
Go to the next disc	Press DISC SKIP
Select a disc directly	Press DISC 1 – 5
Stop play and remove the CD	Press 

Using the Display

You can check information about the disc using the display.

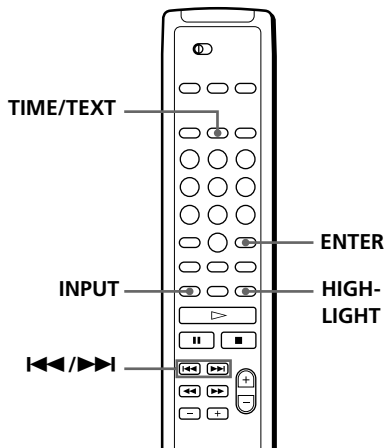
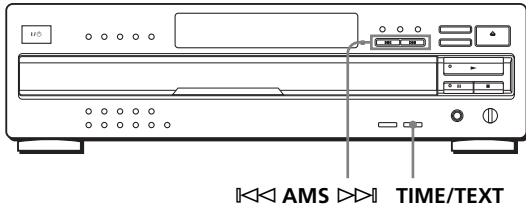

Checking the total number and playing time of the tracks

Press TIME/TEXT before you start playing. The display shows the current disc number, the total number of tracks, total playing time, and music calendar.

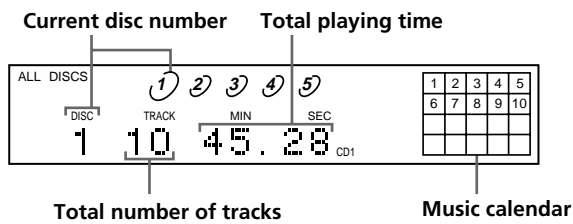

The information also appears when you press the OPEN/CLOSE button to close the disc tray. The tracks numbered over 20 cannot be displayed in the music calendar.

Notes on the disc number indications

- The red circle around a disc number indicates the disc is ready to be played.
- When all the tracks on a disc have been played, the semi-circle around the disc number disappears.
- When a disc compartment is recognized as empty, the semi-circled disc number disappears.

Display information while playing a disc

While playing a disc, the display shows the current disc number, current track number, playing time of the track, and the music calendar.

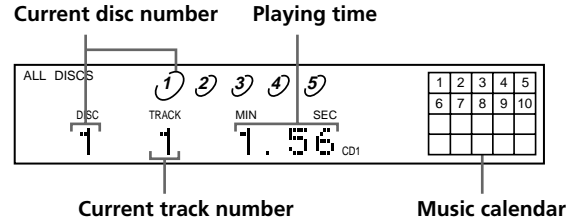

The track numbers in the music calendar disappear after they are played.

Checking the remaining time

Each time you press the TIME/TEXT button while playing a disc, the display changes as shown in the chart below.

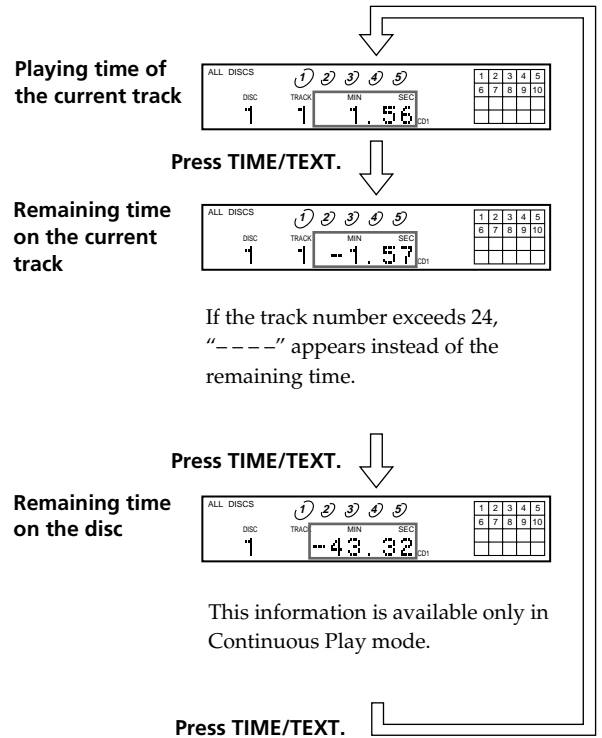

This information is available only in Continuous Play mode.

Checking the information of CD TEXT discs

CD TEXT discs have information, such as the disc titles or artist names, memorized in a blank space on the discs where on normal discs there is no information. The display shows the CD TEXT information of the disc so that you can check the current disc title, artist name and track title. When the player detects CD TEXT discs, the "CD-TEXT" indication lights up in the display. Each time you press the TIME/TEXT button, the display changes as shown in the charts below.

• Before you start playing

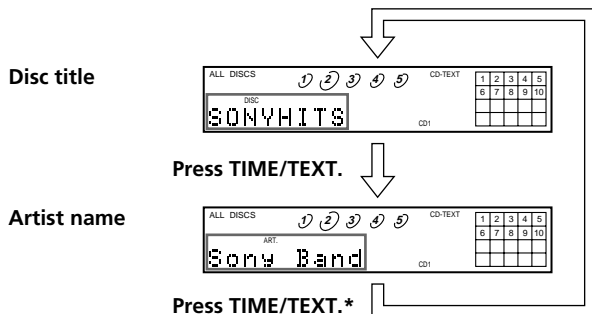

* The display shows the current disc number, total number of tracks, and total playing time of the disc for a few seconds before returning to the disc title indication.

• While playing a disc

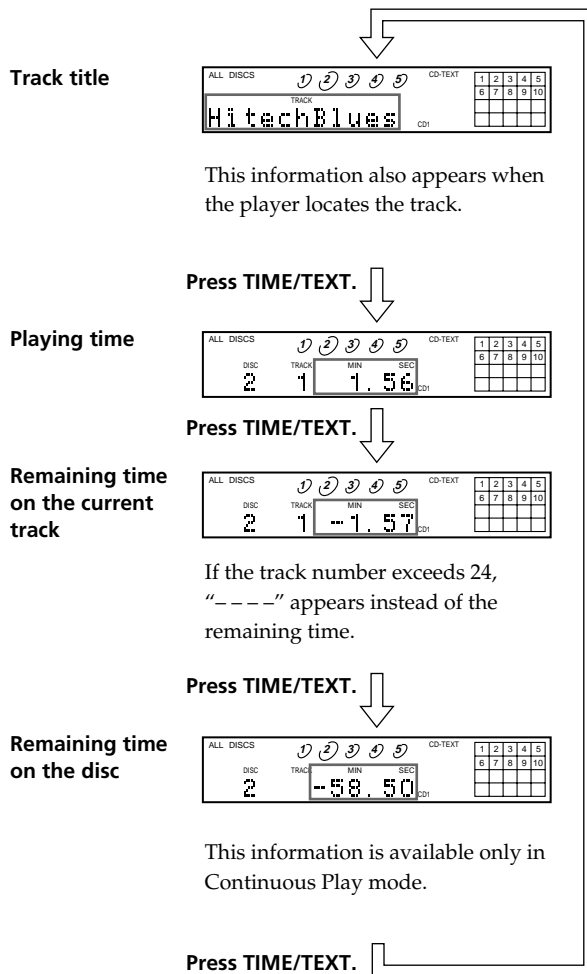

If each CD TEXT information has more than 12 characters, the first 12 characters light up after all the characters are first scrolled by in the display.

Note

This player can only display the disc titles, track titles and artist names from CD TEXT discs. The other CD TEXT information cannot be displayed.

To play disc highlights

Some CD TEXT discs have a feature which plays only the highlights of the discs. When you select such a disc, "HIGH LIGHT" appears in the display. Press HIGH-LIGHT on the remote to start playing disc highlights in the stop mode. "HIGH LIGHT" flashes in the display while playing disc highlights.

Selecting the language of the CD TEXT information

You can select the language used to display the CD TEXT information when you select a CD TEXT disc with multi-language information. Once you select the language, the display shows the information in the selected language until you turn off the player. If the player cannot read the language memorised in a CD TEXT disc, the display shows “<other lang>.”

- 1 Press INPUT in stop mode. “SELECT LANG.” appears momentarily, then “ENGLISH” appears in the display.

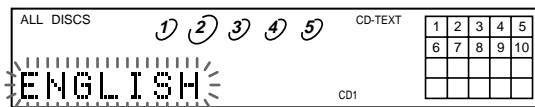

- 2 Press ◀▶ until the language you want appears in the display.
- 3 Press ENTER to select the language. “Reading Text” appears momentarily, then the display shows the information in the selected language.

To check the current language

- 1 Press INPUT while playing a CD TEXT disc. “SHOW LANG.” appears in the display.
- 2 Press ENTER. The current language appears momentarily. You can also check the current language while selecting a CD TEXT disc without multi-language information.

Note

If you select a CD TEXT disc which does not contain the information of the selected language, the display shows the information in another language according to the disc’s priority.

Replacing Other Discs While Playing a Disc

You can open the disc tray while playing a disc so that you can check what discs are to be played next and replace discs without interrupting play of the current disc.

EX-CHANGE DISC SKIP

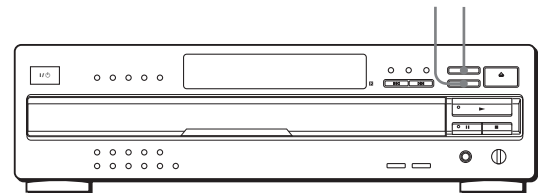

- 1 Press EX-CHANGE. The disc tray opens and two disc compartments appear. Even if the player is playing a disc, it doesn’t stop playing.
- 2 Replace discs in the compartments with new ones. The player plays the disc on the left side compartment after the current disc, and then the one on the right side compartment.
- 3 Press DISC SKIP. The disc tray turns and another two disc compartments appear.
- 4 Replace discs in the compartments with new ones.
- 5 Press EX-CHANGE. The disc tray closes.

While the disc tray is open by pressing the EX-CHANGE button

- If the play of the current disc ends, the player stops playing. If the disc is played in 1 DISC Repeat Play mode (see page 12), the current disc starts playing again.
- In ALL DISCS Shuffle Play mode (see page 13), tracks are reshuffled on the current disc.
- In Program Play mode (see page 13), only the tracks on the current disc are played.
- Do not push the disc tray to close it in Step 5, as you may damage the player.

Locating a Specific Disc

You can locate any disc before or while playing a disc.

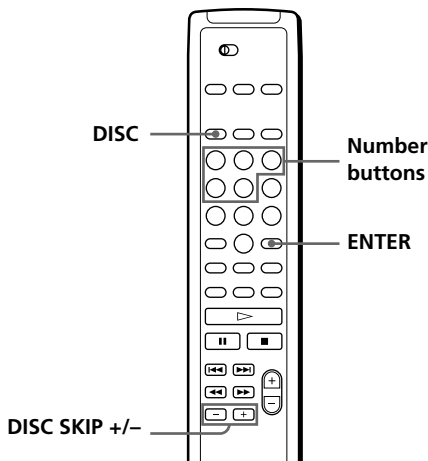
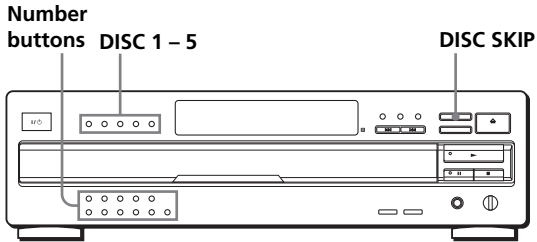

To locate	Press
The next disc	DISC SKIP while playing a disc
The next or succeeding discs	DISC SKIP + repeatedly until you find the disc
The current or preceding discs	DISC SKIP - repeatedly until you find the disc
A specific disc directly	DISC 1 - 5. When using the remote, follow the procedure below. 1 Press DISC. 2 Press the number button of the disc. 3 Press ENTER.

Locating a Specific Track

You can quickly locate any track while playing a disc using the AMS (AMS: Automatic Music Sensor) button or number buttons on the remote.

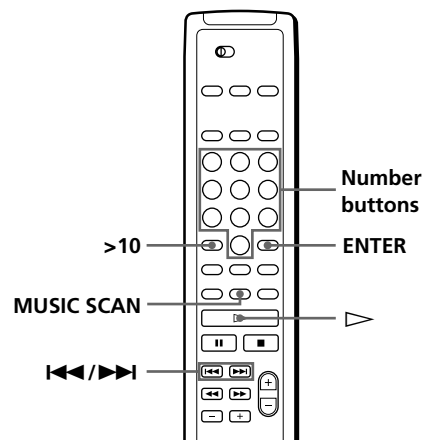
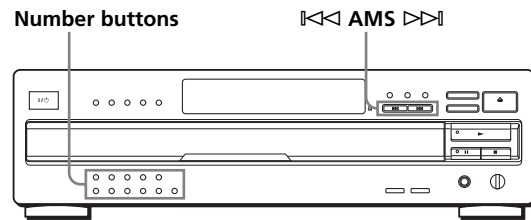

To locate	You need to
The next or succeeding tracks	Press until you find the track. When using the remote, press repeatedly until you find the track.
The current or preceding tracks	Press until you find the track. When using the remote, press repeatedly until you find the track.
A specific track directly	Press the number button of the track
A track by scanning each track for 10 seconds (Music Scan)	Press MUSIC SCAN on the remote before you start playing. When you find the track you want, press (the indicator lights up green) to start playing.

To directly locate a track numbered over 10

Press >10 first, then the corresponding number buttons. To enter "0," use button 10/0.

Example: To play track number 30

Press >10 first, then 3 and 10/0.

You can extend the playing time during Music Scan

Press MUSIC SCAN repeatedly until the playing time you want (10, 20 or 30) appears in the display. Each time you press the button, the playing time changes cyclically.

Locating a Particular Point in a Track

You can also locate a specific point in a track while playing a disc.

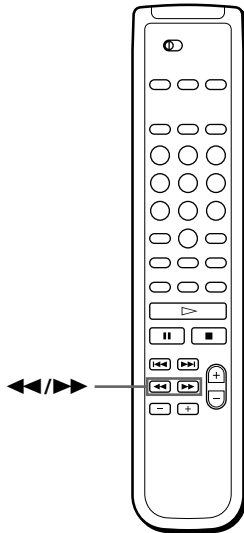

To locate	Press
A point while monitoring the sound	▶▶ (forward) or ◀◀ (backward) and hold down until you find the point
A point quickly by observing the display during pause	▶▶ (forward) or ◀◀ (backward) and hold down until you find the point. You will not hear the sound during the operation.

Note

If "OVER" appears in the display, the disc has reached the end while you were pressing the ▶▶ button. Press ◀◀ to go back.

Playing Repeatedly

You can play discs/tracks repeatedly in any play mode.

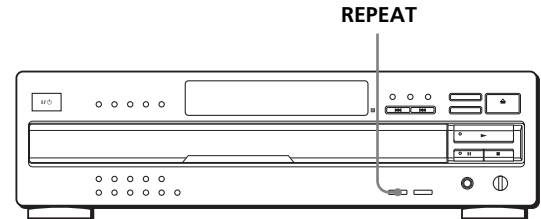

Press REPEAT while playing a disc. "REPEAT" appears in the display. The player repeats the discs/tracks as follows:

When the disc is played in	The player repeats
ALL DISCS Continuous Play (page 6)	All the tracks on all discs
1 DISC Continuous Play (page 6)	All the tracks on the current disc
ALL DISCS Shuffle Play (page 13)	All the tracks on all discs in random order
1 DISC Shuffle Play (page 13)	All the tracks on the current disc in random order
Program Play (page 13)	The same program

To cancel Repeat Play

Press REPEAT repeatedly until "REPEAT OFF" appears in the display.

Repeating the current track

You can repeat only the current track while the disc is played in any play mode.

While the track you want is being played, press REPEAT repeatedly until "REPEAT 1" appears in the display.

To cancel Repeat 1

Press REPEAT.

Playing in Random Order (Shuffle Play)

You can have the player “shuffle” tracks and play in random order. The player shuffles all the tracks on all discs or on the disc you’ve specified.

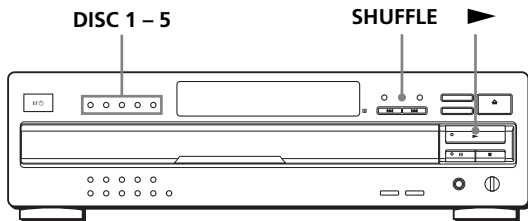

Shuffle Play on all discs

You can play all tracks on all discs in a random order.

- 1 Press SHUFFLE repeatedly until “ALL DISCS” appears in the display.
- 2 Press ► (the indicator lights up green) to start ALL DISCS Shuffle Play. The [CD] indication appears while the player is “shuffling” the tracks.

To cancel Shuffle Play

Press CONTINUE.

You can start Shuffle Play while playing

Press SHUFFLE, and Shuffle Play starts from the current track.

You can specify discs during Shuffle Play (Select Shuffle Play)

You can specify discs during ALL DISCS Shuffle Play mode, and the tracks on the specified discs are played in a random order.

Press DISC 1 – 5 to specify the discs after Step 1. Semi-circles appear around the specified disc numbers in the display. To cancel the selected discs, press DISC 1 – 5 again. The semi-circles disappear. To return to ALL DISCS Shuffle Play, press SHUFFLE twice.

Shuffle Play on one disc

You can play all tracks on the specific disc in a random order.

- 1 Press SHUFFLE repeatedly until “1 DISC” appears in the display.
- 2 Press DISC 1 – 5 to start 1 DISC Shuffle Play on the selected disc. The indicator lights up green. The [CD] indication appears while the player is “shuffling” the tracks.

To cancel Shuffle Play

Press CONTINUE.

You can start Shuffle Play while playing

Press SHUFFLE, and Shuffle Play starts from the current track.

Creating Your Own Program (Program Play)

You can arrange the order of the tracks on the discs and create your own program. The program can contain up to 32 “steps” — one “step” may contain a track or a whole disc.

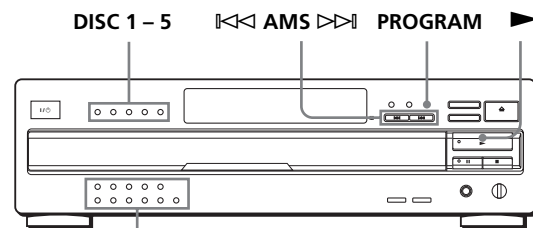

Number buttons

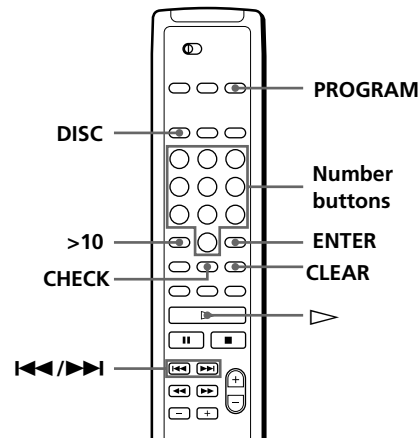

Creating a program on the player

- 1 Press PROGRAM. “PROGRAM” appears in the display. If a program is already stored, the last step of the program appears in the display. When you want to erase the whole program, hold down CLEAR until “CLEAR” appears in the display (see page 15).
- 2 Press DISC 1 – 5 to select the disc.



“AL” in the display stands for “all” tracks.

When you want to program the whole disc as one step, skip Step 3 and go to Step 4.

(Continued)

- 3** Press the number buttons of the tracks you want to program in the order you want.
To program, the track numbered over 10, use the >10 button.

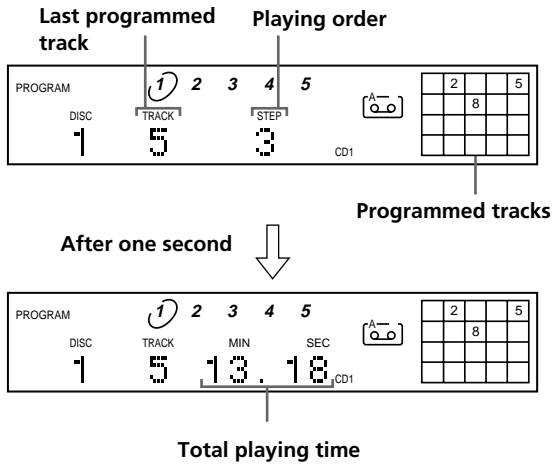

To make a correction

Press CLEAR, then repeat this step.

- 4** To program other discs or tracks, do the following:

To program	Repeat Step(s)
All tracks on other discs	2
Other tracks on the same disc	3
Other tracks on other discs	2 and 3

- 5** Press ► (the indicator lights up green) to start Program Play.

To cancel Program Play

Press CONTINUE.

💡 You can create your program while checking the disc labels

While the disc tray is open, follow Steps 1 to 5 while pressing the DISC SKIP button after each step to check the disc labels. If you close the disc tray before Step 5, the total playing time appears in the display after a while. Note that, if the programmed track number isn't found on the disc, that step is automatically erased.

💡 The program remains even after the Program Play ends

When you press the ► button, you can play the same program again.

💡 The program remains until you erase it or turn off the player

If you replace discs, the programmed disc and track numbers remain. So, the player plays only the existing disc and track numbers. However, the disc and track numbers that aren't found in the player or on the disc are deleted from the program, and the rest of the program is played in the programmed order.

Note

- The total playing time doesn't appear when:
 - You have programmed a track whose number exceeds 20.
 - The total playing time of the program exceeds 200 minutes.

Creating a program using the remote

- Press PROGRAM.
"PROGRAM" appears in the display.
- Press DISC.

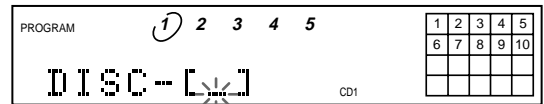

- Press the number button of the disc.

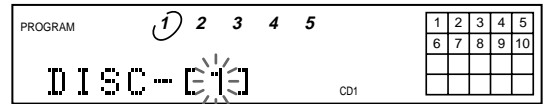

- Press ENTER to select the disc.

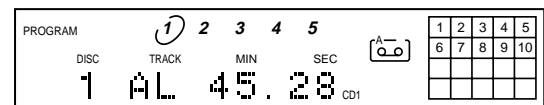

When you want to program the whole disc as one step, skip Steps 5 to 6, and go to Step 7.

- Press ◀▶ until the track number you want appears in the display.

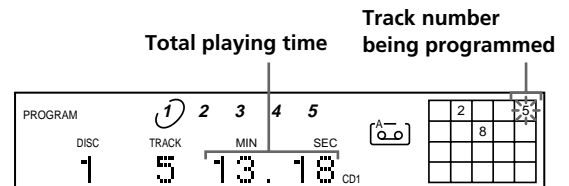

6 Press ENTER to select the track.

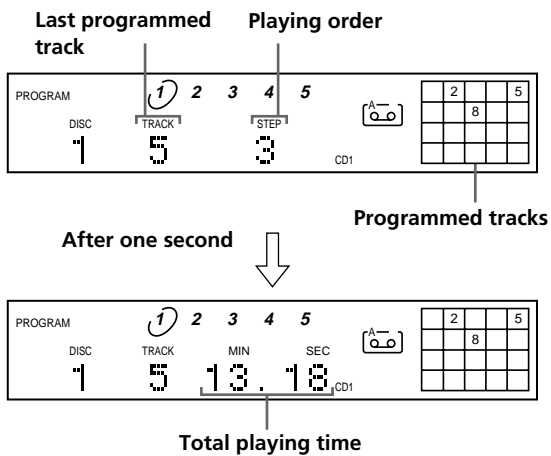

7 To program other discs or tracks, do the following:

To program	Repeat Steps
All tracks on other discs	2 through 4
Other tracks on the same disc	5 and 6
Other tracks on other discs	2 through 6

8 Press ► (the indicator lights up green) to start Program Play.

To cancel Program Play

Press CONTINUE.

💡 You can select a track directly using the number buttons

Press the number button of the track in Step 5. To select a track numbered over 10, use the >10 button (see page 11).

💡 You can create your program while checking the disc labels

While the disc tray is open, follow Steps 1 to 8 with pressing the DISC SKIP button to check the disc labels. If you close the disc tray before Step 8, the total playing time appears in the display after a while.

Note that, if the programmed track number isn't found on the disc, that step is automatically erased.

Note

The total playing time doesn't appear when:

- You have programmed a track whose number exceeds 20.
- The total playing time of the program exceeds 200 minutes.

Checking the track order

You can check your program before or after you start playing.

Press CHECK.

Each time you press this button, the display shows the track (the disc and track numbers) or the disc (the disc number and "AL" indication) of each step in the programmed order. After the last step in the program, the display shows "– END –" and returns to the original display. If you check the order after you start playing, the display shows only the remaining steps.

Changing the track order

You can change your program before you start playing.

To	You need to
Erase a track	Press CHECK until the track you don't want appears in the display, then press CLEAR
Erase the last track in the program	Press CLEAR. Each time you press the button, the last track will be cleared.
Add tracks to the end of the program	Follow the programming procedure
Erase the whole program completely	Hold down CLEAR until "CLEAR" appears in the display. Create a new program following the programming procedure.

Recording Your Own Program

You can record the program you've created on a tape, etc. The program can contain up to 32 steps. By inserting a pause during programming, you can divide the program into two for recording on both sides of a tape.

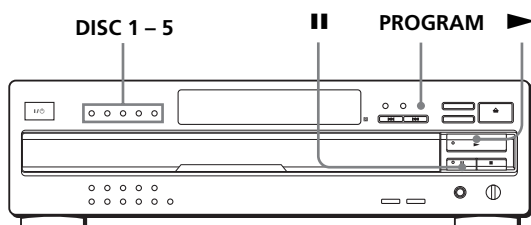

- 1 Create your program (for side A when recording on a tape) while checking the total playing time indicated in the display. Follow Steps 1 through 4 in "Creating a program on the player" on page 13. The indication appears in the display.
- 2 When you record on both sides of the tape, press **||** to insert a pause. The "PAUSE" and indications appear in the display and the playing time is reset to "0.00." When you record on one side of the tape, skip this step and go to Step 4.

A pause is counted as one step
You can program up to 31 steps when you insert a pause.
- 3 Repeat Steps 2 through 4 in "Creating a program on the player" to create the program for side B.
- 4 Start recording on the deck and then press **▶** (the indicator lights up green) on the player. When you record on both sides of the tape, the player pauses at the end of the program for side A.
- 5 When you record on side B, reverse the tape and press **▶** or **||** on the player to resume playing.

You can check and change your program

See page 15.
The indication appears while checking the program for side A and while checking the program for side B.

Fading In or Out

You can manually fade the sound in or out to prevent tracks from starting or ending abruptly. Note that you cannot use this effect when you use the DIGITAL OUT (OPTICAL) connector.

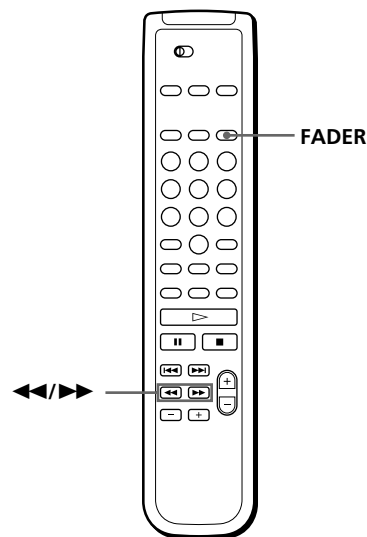

To	Press FADER
Start play fading in	During pause. lights up in the display and the indication flashes. The play fades in.
End play fading out	When you want to start fading out. lights up in the display and the indication flashes. The play fades out and the player pauses.

Note

Fading lasts for about 5 seconds. However, when you press the FADER button during Music Scan (see page 11), the play fades out for about 2 seconds.

Changing the fading time

You can change the fading time from 2 to 10 seconds before fading in or out. If you don't change it, fading lasts for 5 seconds.

- 1 Press FADER before you start playing. "FADE 5 SEC" appears in the display.
- 2 Press **◀/▶** to specify the fading time.

What You Can Do With the Custom Files

The player can store two types of information called "Custom Files" for each disc. Once you have stored Custom Files for a disc, the player automatically recalls what you have stored whenever you select the disc. Note that Custom Files will be erased if you do not use the player for about one month.

You can store this information:

When you use	You can
Disc Memo (page 17)	Label discs using up to 12 characters
Delete Bank (page 19)	Delete unwanted tracks and store only the tracks you want

Where are Custom Files stored?

Custom Files are stored not on the disc, but in the player's memory. Therefore you cannot use Custom Files when you play the disc on other players.

Erasing all Custom Files of all discs

Turn off the player. While holding down >10, press I/⏻ to turn on the player. "ALL ERASE" appears in the display, and all Custom Files will be erased.

How many discs can you file?

You can file up to 255 discs in the Custom File. You can check how many discs you can file as follows: Remove all the discs in the player, then press ≡ OPEN/CLOSE. Wait for "-NO DISC-" to appear in the display, then press TIME/TEXT. "REMAIN: XXX" appears in the display to show you how many discs you can file. Each time you press TIME/TEXT, the display shows the Custom Files for each disc. After the last Custom File, "- END -" appears for a while, then "-NO DISC-" appears.

Labeling Discs (Disc Memo)

You can label discs using up to 12 characters and have the player display the Disc Memo each time you select the disc. The Disc Memo can be anything you like, such as a title, musician's name, category, or date of purchase.

When you select a CD TEXT disc

The disc title is stored as the Disc Memo automatically. If the disc title has more than 12 characters, the first 12 characters of the disc title are stored (see page 9). Note that you cannot change the Disc Memo of the CD TEXT disc.

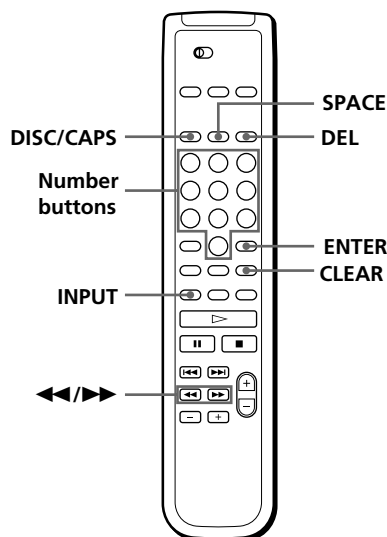

- 1 Select the disc.
- 2 Press INPUT. "MEMO INPUT" appears momentarily, then the flashing cursor (◀) appears.
- 3 Press DISC/CAPS to find the letter type you want. Each time you press the button, the letter type changes cyclically among capital letters (ABC), small letters (abc) and numbers (123). To select a symbol, you have to select the capital or small letter type.
- 4 To input a letter, press the number button corresponding to the letter you want (indicated beside each number button). The cursor disappears and the first space for the Disc Memo flashes. Each time you press the button, the letter changes cyclically among the ones indicated beside the button.

(Continued)

Storing Information About CDs (Custom Files)

To input symbols, press the number button 1 repeatedly until the symbol you want appears in the display.

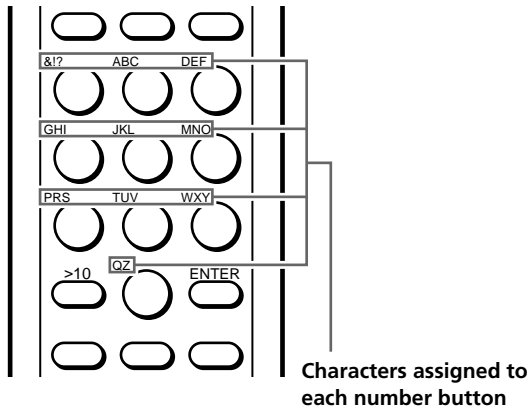

Example: To select the letter E
Press the number button 3 twice.

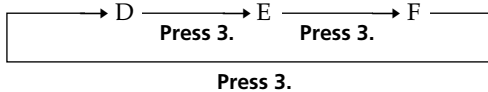

To insert a space, press SPACE once.

To input a number, press the number button you want.

- 5 Press ENTER to select the character.
The selected character lights up, and the flashing cursor appears to indicate the next space to be input.
You can also go to the next space by pressing other number buttons.
- 6 Repeat Steps 3 through 5 to input more characters.
- 7 Press INPUT to store the Disc Memo.
Repeat Steps 1 through 7 to assign Disc Memos to other discs.

💡 If you make a mistake while inputting the character

To correct the character which has been input

- 1 Press ◀ or ▶ until the cursor moves next to the incorrect character.

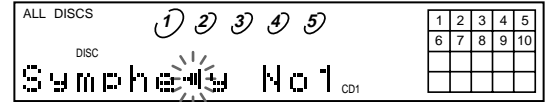

- 2 Press DEL to delete the incorrect character.

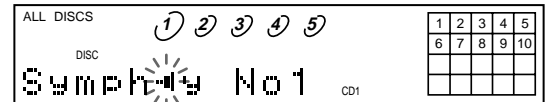

- 3 Input the correct character.

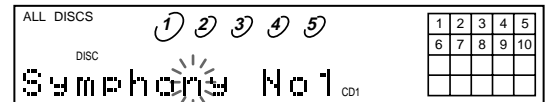

To correct the character currently being input

- 1 Press DEL to delete the incorrect character.
- 2 Input the correct character.

To insert a character between the input characters

Press ◀ or ▶ until the cursor moves next to the point you want to insert, and enter the character.

Erasing the Disc Memo

- 1 Follow Steps 1 and 2 in "Labeling discs" on page 17 to select the Disc Memo you want to erase.
- 2 Press CLEAR.
The Disc Memo disappears.
- 3 Press INPUT.

Storing Specific Tracks (Delete Bank)

You can delete unwanted tracks and store only the tracks you want. When you select the disc containing a Delete Bank, you can play only the remaining tracks.

Note

The deleted tracks are skipped even in the Program Play mode (when the whole disc containing a Delete Bank is programmed as one step).

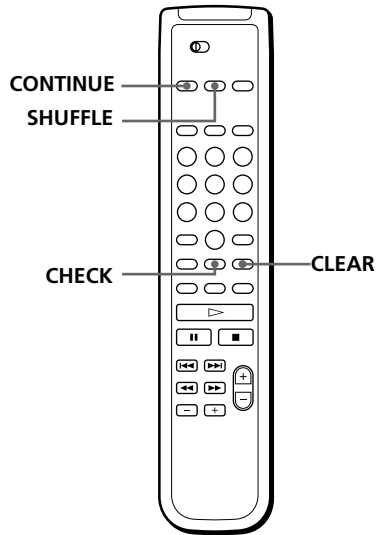

- 1 Select the disc.
- 2 Press CONTINUE or SHUFFLE before you start playing.
- 3 Press CHECK repeatedly until the track you want to delete appears in the display.

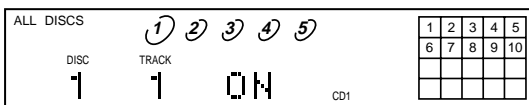

- 4 Press CLEAR.
"DELETE" and "OFF" appear in the display.

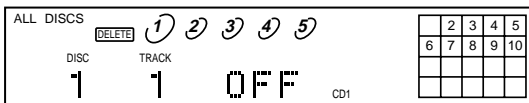

If you want to recover the track, press CLEAR again.

- 5 Repeat Steps 3 and 4 to delete more tracks.



You can recover all the tracks you have deleted

Hold down CLEAR until "ALL SELECT" appears in the display.

Precautions

On safety

- Caution — The use of optical instruments with this product will increase eye hazard.
- Should any solid object or liquid fall into the cabinet, unplug the player and have it checked by qualified personnel before operating it any further.

On power sources

- Before operating the player, check that the operating voltage of the player is identical with your local power supply. The operating voltage is indicated on the nameplate at the rear of the player.
- The player is not disconnected from the AC power source (mains) as long as it is connected to the wall outlet, even if the player itself has been turned off.
- If you are not going to use the player for a long time, be sure to disconnect the player from the wall outlet. To disconnect the AC power cord (mains lead), grasp the plug itself; never pull the cord.
- AC power cord must be changed only at the qualified service shop.

On placement

- Place the player in a location with adequate ventilation to prevent heat build-up in the player.
- Do not place the player on a soft surface such as a rug that might block the ventilation holes on the bottom.
- Do not place the player in a location near heat sources, or in a place subject to direct sunlight, excessive dust or mechanical shock.

On operation

- If the player is brought directly from a cold to a warm location, or is placed in a very damp room, moisture may condense on the lenses inside the player. Should this occur, the player may not operate properly. In this case, remove the disc and leave the player turned on for about an hour until the moisture evaporates.

On adjusting volume

- Do not turn up the volume while listening to a portion with very low level inputs or no audio signals. If you do, the speakers may be damaged when a peak level portion is played.

On cleaning

- Clean the cabinet, panel and controls with a soft cloth slightly moistened with a mild detergent solution. Do not use any type of abrasive pad, scouring powder or solvent such as alcohol or benzine.

If you have any questions or problems concerning your player, please consult your nearest Sony dealer.

Notes on CDs

On handling CDs

- To keep the disc clean, handle the disc by its edge. Do not touch the surface.
- Do not stick paper or tape on the disc.

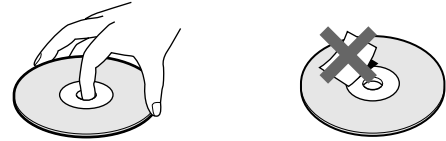

- Do not expose the disc to direct sunlight or heat sources such as hot air ducts, nor leave it in a car parked in direct sunlight as there can be considerable rise in temperature inside the car.
- Do not use any commercially available stabilizer. If you do, the disc and the player may be damaged.
- After playing, store the disc in its case.

On cleaning

- Before playing, clean the disc with a cleaning cloth. Wipe the disc from the center out.

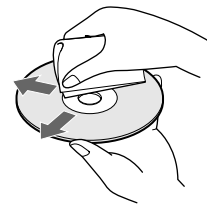

- Do not use solvents such as benzine, thinner, commercially available cleaners or anti-static spray intended for vinyl LPs.

Troubleshooting

If you experience any of the following difficulties while using the player, use this troubleshooting guide to help you remedy the problem. Should any problem persist, consult your nearest Sony dealer.

There's no sound.

- ➔ Check that the player is connected securely.
- ➔ Make sure you operate the amplifier correctly.
- ➔ Adjust the output level using the LINE OUT LEVEL +/- buttons on the remote.

The CD does not play.

- ➔ There's no CD inside the player ("–NO DISC–" appears). Insert a CD.
- ➔ Place the CD with the label side up on the disc tray correctly.
- ➔ Clean the CD (see page 20).
- ➔ Moisture has condensed inside the player. Remove the disc and leave the player turned on for about an hour (see page 20).
- ➔ Place the CD in the correct position on the disc tray.

The remote does not function.

- ➔ Remove the obstacles in the path of the remote and the player.
- ➔ Point the remote at the remote sensor  on the player.
- ➔ Replace all the batteries in the remote with new ones if they are weak.
- ➔ Set the CD 1/2/3 switch on the remote according to the position of the COMMAND MODE selector at the rear panel of the player.

The player functions incorrectly.

- ➔ The microcomputer chips may be operating incorrectly. Turn the power off, then turn it back on to reset the player.

Specifications

Compact disc player

Laser	Semiconductor laser ($\lambda = 780 \text{ nm}$) Emission duration: continuous
Laser output	Max 44.6 μW * * This output is the value measured at a distance of 200 mm from the objective lens surface on the Optical Pick-up block with 7 mm aperture.
Frequency response	2 Hz to 20 kHz $\pm 0.3 \text{ dB}$
Signal-to-noise ratio	More than 117 dB
Dynamic range	More than 99 dB
Harmonic distortion	Less than 0.0025%
Channel separation	More than 110 dB

Output

	Jack type	Maximum output level	Load impedance
LINE OUT	Phono jacks	2 V (at 50 kilohms)	Over 10 kilohms
DIGITAL OUT (OPTICAL)	Optical output connector	-18 dBm	Wave length: 660 nm
PHONES	Stereo phone jack	15 mW	32 ohms

General

Power requirements

Where purchased	Power requirements
USA	120 V AC, 60 Hz
Europe/ Certain countries in Asia	220 V – 230 V AC, 50/60 Hz
Other countries	110 V – 120 V AC or 220 V – 240 V AC adjustable, 50/60 Hz

Power consumption	15 W
Dimensions (approx.) (w/h/d)	430 × 125 × 400 mm (17 × 5 × 15 3/4 in.) incl. projecting parts
Mass (approx.)	7.0 kg (15 lbs 7 oz)

Supplied accessories

- Audio cord (2 phono plugs – 2 phono plugs) (1)
- Remote commander (remote) (1)
- Size AA (R6) batteries (2)

Design and specifications are subject to change without notice.

Index

A, B

- AMS 11
- Automatic Music Sensor. *See* AMS

C, D

- CD TEXT 9
- Connecting 4
- Continuous Play 6
- Custom Files
 - Delete Bank 19
 - Disc Memo 17
 - what you can do with 17

E

- Editing. *See* Recording
- Erasing
 - Custom Files 17
 - Delete Bank 19
 - Disc Memo 17

F, G

- Fading 16

H, I, J, K

- Handling CDs 20
- Hookups 4
 - overview 4

L

- Labeling a disc 17
- Locating
 - directly 11
 - using AMS 11

M, N, O

- Music Scan 11

P, Q

- Playback
 - Continuous Play 6
 - Program Play 13
 - Repeat Play 12
 - Shuffle Play 13
- Program 13
 - changing 15
 - checking 15
 - for recording 16

R

- Recording 16
 - a program 16
- Remaining time 8
- Remote control 4
- Repeating 12
- Replacing discs while playing
 - a disc 10

S

- Scanning. *See* Music Scan
- Searching. *See* Locating
- Select Shuffle Play 13
- Selecting the language 10
- Shuffle Play 13
- Storing
 - information about CDs 20
 - specific tracks 19

T

- Total playing time 8
- Troubleshooting 21

U, V, W, X, Y, Z

- Unpacking 4

Names of controls

Buttons

- CHECK 15
- CLEAR 15
- CONTINUE 6
- DISC 11
- DISC 1-5 11
- DISC/CAPS 17
- DISC SKIP 11
- ENTER 11
- EX-CHANGE 10
- FADER 16
- HIGH-LIGHT 9
- INPUT 10, 17
- LINE OUT LEVEL +/- 5
- INPUT 18
- MUSIC SCAN 11
- Number 11
- ≡ OPEN/CLOSE 6
- PROGRAM 13
- REPEAT 12
- SHUFFLE 13
- TIME/TEXT 8
- ▶ 7
- ⏏ 7
- 7
- ⏮ AMS ⏭ 7
- ◀/▶ 12
- ⏮/▶ 11
- > 10 11

Jack

- PHONES 6

Switch

- I/⏻ 6

Others

- Disc tray 6
- Display 8
- ⏏ 4

