

# *Compact Hi-Fi Stereo System*

---

Operating Instructions



<i>LBT-D390</i>	<i>LBT-XB44K</i>
<i>LBT-D790</i>	<i>LBT-XB50</i>
<i>LBT-G5500</i>	<i>LBT-XB60</i>
<i>LBT-XB33</i>	<i>LBT-XB66</i>
<i>LBT-XB33K</i>	<i>LBT-XB66K</i>
<i>LBT-XB44</i>	<i>LBT-XB660</i>

## WARNING

**To prevent fire or shock hazard, do not expose the unit to rain or moisture.**

To avoid electrical shock, do not open the cabinet. Refer servicing to qualified personnel only.

Do not install the appliance in a confined space, such as a bookcase or built-in cabinet.

Laser component in this product is capable of emitting radiation exceeding the limit for Class 1.

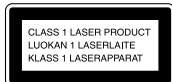

This appliance is classified as a CLASS 1 LASER product. The CLASS 1 LASER PRODUCT MARKING is located on the rear exterior.

This caution label is located inside the unit.



This stereo system is equipped with the Dolby\* B-type noise reduction system.

\* Dolby noise reduction manufactured under license from Dolby Laboratories Licensing Corporation.

“DOLBY” and the double-D symbol  are trademarks of the Dolby Laboratories Licensing Corporation.

# Table of Contents

## Getting Started

Step 1: Hooking up the system .....	4
Step 2: Setting the time .....	6
Step 3: Presetting radio stations .....	7
Connecting optional AV components .....	8

## Basic Operations

Playing a CD .....	11
Recording a CD .....	13
Listening to the radio .....	14
Recording from the radio .....	15
Playing a tape .....	16
Recording from a tape .....	18

## The CD Player

Using the CD display .....	19
Playing CD tracks repeatedly .....	19
Playing CD tracks in random order .....	20
Programming CD tracks .....	21
Playing CDs without interruption .....	22

## The Tape Deck

Recording on a tape manually .....	23
Recording CDs by specifying the track order .....	24

## DJ Effects

Looping part of a CD .....	26
Flashing part of a CD .....	26
Waving the equalizer .....	27

## Sound Adjustment

Adjusting the sound .....	28
Selecting the audio emphasis .....	29
Adjusting the audio emphasis .....	30
Making a personal audio emphasis file .....	31

## Other Features

Using the Radio Data System (RDS)* .....	32
Singing along: Karaoke .....	34
Falling asleep to music .....	36
Waking up to music .....	37
Timer-recording radio programs .....	38

## Additional Information

Precautions .....	40
Troubleshooting .....	41
Specifications .....	43
Index .....	46

\* For European model only

### Notice for customers in the United Kingdom

The AC power cord has been fixed on the rear panel with the plug band temporarily for shipment.

Unlock the plug band to remove the plug.

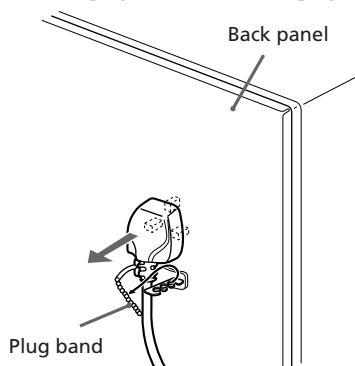

## Step 1: Hooking up the system

Follow steps **1** through **5** to hook up your system using the supplied cords and accessories.

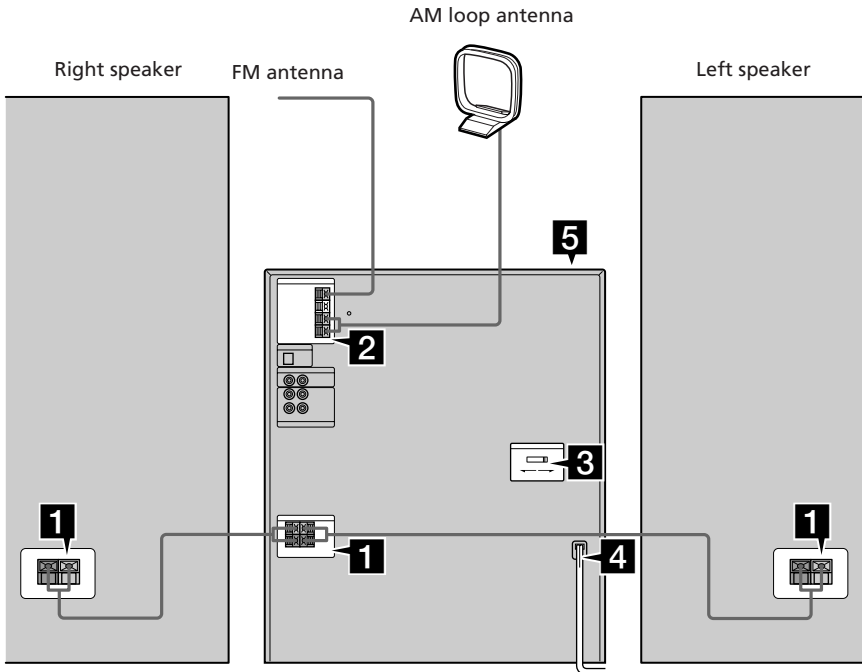

The above illustration is of the LBT-XB66K.

### **1** Connect the speakers.

- 1** Connect the speaker cords to SPEAKER jacks of the same color. Keep the speaker cords away from the antennas to prevent noise.

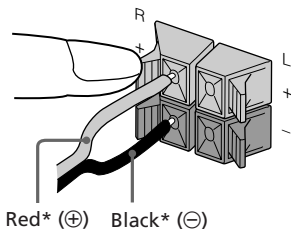

- 2** Insert only the stripped portion of the cord. Inserting the vinyl portion will interfere with the speaker connection and no sound will come from the speaker.

### **Note**

The speakers for LBT-D390/G5500/XB33/XB33K/XB50 do not have the speaker jacks. Connect the speaker cords to the speaker jacks on the unit.

\* The color of your speaker cords might be different. See the speakers' manual for details if supplied.

- 2** Connect the FM/AM antennas.  
Set up the AM loop antenna, then connect it.

**For European model**

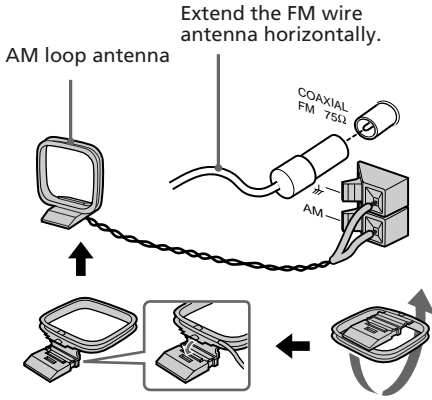

**For other models**

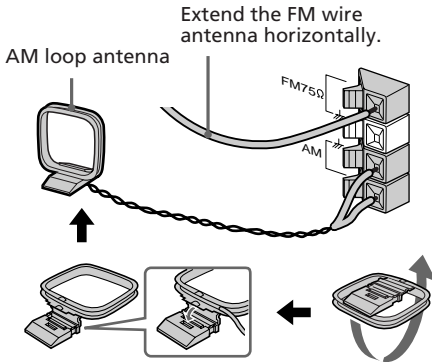

- 3** Set VOLTAGE SELECTOR to the position of your local power line voltage (except for North American, European, Mexican, South African, Thailand and Australian models).

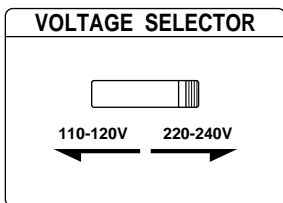

- 4** Connect the power cord to a wall outlet.

The demonstration appears in the display.  
If the plug on this unit does not fit your wall outlet, detach the supplied adapter from the plug (except for North and South American countries, Europe and Australia).

- 5** Deactivate the demonstration mode by pressing DISPLAY/DEMO while the system is off.

**Inserting two size AA (R6) batteries into the remote**

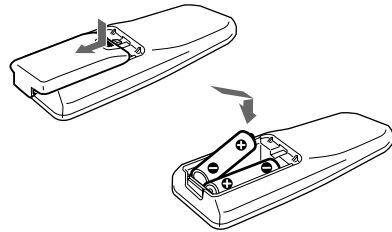

**Tips**

- With normal use, the batteries should last for about six months. When the remote no longer operates the system, replace both batteries with new ones.
- When you set the time, the demonstration is deactivated.

To activate the demonstration again, press DISPLAY/DEMO while the system is off.

**Note**

If you do not use the remote for a long period of time, remove the batteries to avoid possible damage from battery leakage.

**When carrying this system**

Do the following to protect the CD mechanism.

- 1** Press FUNCTION repeatedly until "CD" appears in the display.
- 2** Hold down PLAY MODE and press I/⏻ to turn off the system.

## Step 2: Setting the time

You must set the time before using the timer functions. The clock is on a 24-hour system for the European and Brazilian models, and a 12-hour system for other models.

The 24-hour system model is used for illustration purpose.

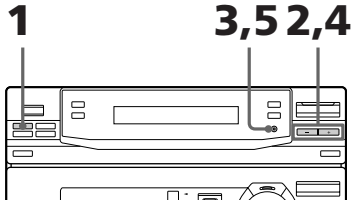

### LBT-D390/D790/G5500/XB33/XB33K/XB44/XB44K/XB50/XB60 only

- 1 Press /CLOCK SET.  
The hour indication flashes.

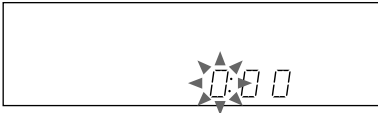

- 2 Press TUNING +/- to set the hour.

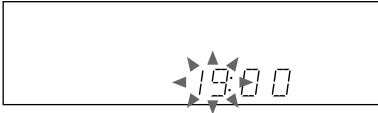

- 3 Press ENTER/NEXT.  
The minutes indication flashes.



- 4 Press TUNING +/- to set the minutes.

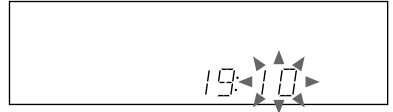

- 5 Press ENTER/NEXT.  
The clock starts.

### LBT-XB66/XB66K/XB660 only

- 1 Press /CLOCK SET.  
The hour indication flashes.



- 2 Press TUNING +/- to set the hour.



- 3 Press ENTER/NEXT.  
The minutes indication flashes.



- 4 Press TUNING +/- to set the minutes.



- 5 Press ENTER/NEXT.  
The clock starts.

### Tip

If you make a mistake, start over from step 1.

# Step 3: Presetting radio stations

You can preset the following number of stations:

- 2 band model: 20 for FM and 10 for AM
- 3 band model: 20 for FM, 10 for MW, and 10 for LW
- 4 band model: 20 for FM, 10 for MW, 10 for LW, and 5 for UKV

The bands you can select depend on the kind of tuner built into your system. Confirm the bands by pressing TUNER/BAND repeatedly.

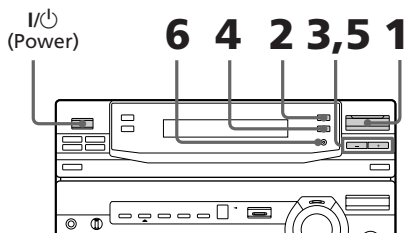

**1** Press TUNER/BAND repeatedly until the band you want appears in the display.

Each time you press this button, the band changes as follows:

2 band model:

FM ↔ AM

3 band model:

FM → MW → LW



4 band model:

FM → MW → LW → UKV\*



\* When you select this band, “STEREO Plus” appears in the display.

**2** Press TUNING MODE repeatedly until “AUTO” appears in the display.

**3** Press TUNING +/-.

The frequency indication changes and scanning stops when the system tunes in a station. “TUNED” and “STEREO” (for a stereo program) appear.

**LBT-D390/D790/G5500/XB33/XB33K/XB44/XB44K/XB50/XB60**

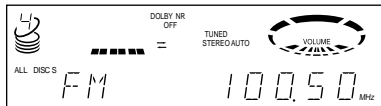

**LBT-XB66/XB66K/XB660**



**4** Press TUNER MEMORY.

A preset number flashes in the display.

**LBT-D390/D790/G5500/XB33/XB33K/XB44/XB44K/XB50/XB60**

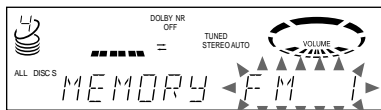

**LBT-XB66/XB66K/XB660**



**5** Press TUNING +/- to select the preset number you want.

**LBT-D390/D790/G5500/XB33/XB33K/XB44/XB44K/XB50/XB60**

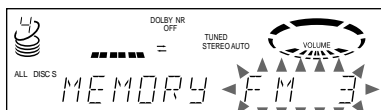

**LBT-XB66/XB66K/XB660**



**6** Press ENTER/NEXT.

The station is stored.

**7** Repeat steps 1 through 6 to store other stations.

### Step 3: Presetting radio stations (continued)

#### To tune in a station with a weak signal

Press TUNING MODE repeatedly until "MANUAL" appears in step 2, then press TUNING +/- to tune in the station.

#### To change the preset number

Start over from step 1.

#### To change the AM tuning interval (Except for the European and the Middle Eastern models)

The AM tuning interval is factory-preset to 9 kHz (10 kHz in some areas). To change the AM tuning interval to 10 kHz (or 9 kHz), press TUNER/BAND repeatedly until "AM" appears first, then turn off the system. While holding down ENTER/NEXT, turn the system back on. When you change the interval, the AM preset stations will be erased. To reset the interval, repeat the same procedure.

#### Note

The preset stations are canceled when you disconnect the power cord or if a power failure occurs for half a day.

## Connecting optional AV components

To enhance your system, you can connect optional components. Refer to the instructions included with each component for details.

## Connecting audio components

### Connecting a turntable

Be sure to match the color of the plugs and the connectors. To listen to the sound from the connected turntable, press FUNCTION repeatedly until "PHONO" appears.

To the audio output of the turntable

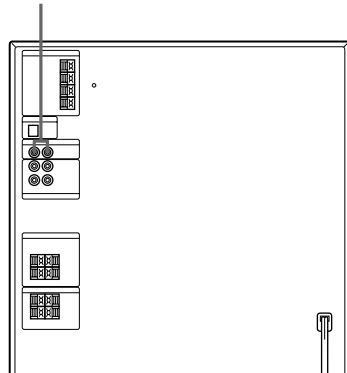

#### Note

Using the turntable at high volume may cause distortion or howling. This is often caused by the bass sound from the speakers. The bass sound may be picked up by the needle of the turntable, and produce the distortion or howling. To avoid this, do the following:

- 1 Keep some distance between the speakers and the turntable.
- 2 Stop using the surround effect.
- 3 Install the speakers or the turntable on a firm and stable surface.
- 4 Press DBFB repeatedly until "DBFB ■■■■■" disappears from the display (LBT-D390/G5500/XB33/XB33K/XB50 only).

Press SUPER WOOFER repeatedly until the indicator on this button goes off (except for LBT-D390/G5500/XB33/XB33K/XB50).



## Connecting an MD deck for digital recording (except for LBT-D390/D790/G5500)

You can record a CD to an MD digitally by connecting your MD deck using an optical cable.

To the digital input of the MD deck

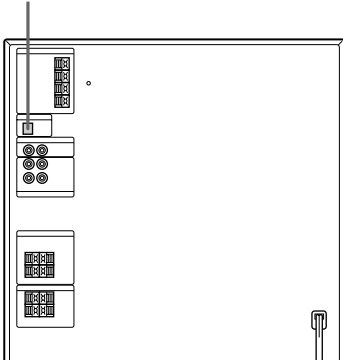

## Connecting surround speakers (LBT-D790/XB33/XB33K/XB50/XB60 only)

You can connect optional surround speakers.

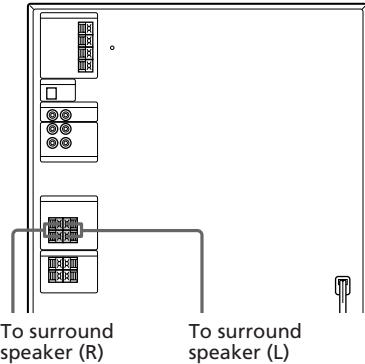

### Note

You need to connect both left and right surround speakers. Otherwise, the sound will not be heard.

## Connecting an MD deck for analog recording (except for LBT-D390/D790/G5500)

Be sure to match the color of the plugs and the connectors. To listen to the sound of the connected MD deck, press FUNCTION repeatedly until "MD" appears.

To the audio outputs of the MD deck      To the audio inputs of the MD deck

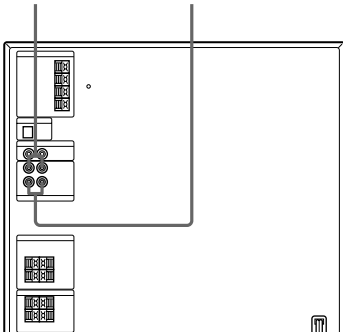

## Connecting a VCR

Be sure to match the color of the plugs and the connectors. To listen to the sound from the connected VCR, press FUNCTION repeatedly until "VIDEO" appears.

To the audio output of the VCR

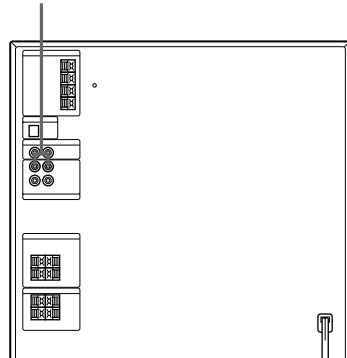

### Note

If you cannot select "MD" by pressing FUNCTION, press I/⏻ while pressing FUNCTION when the power is turned off. "VIDEO" will be switched to "MD." To return to "VIDEO," do the same procedure.

## Connecting optional AV components (continued)

### Connecting outdoor antennas

Connect an outdoor antenna to improve the reception.

#### FM antenna

Connect an optional FM outdoor antenna. You can also use the TV antenna instead.

##### For European model

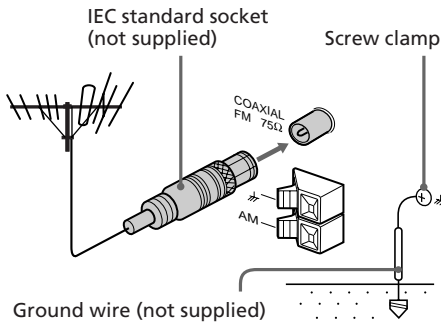

##### For other models

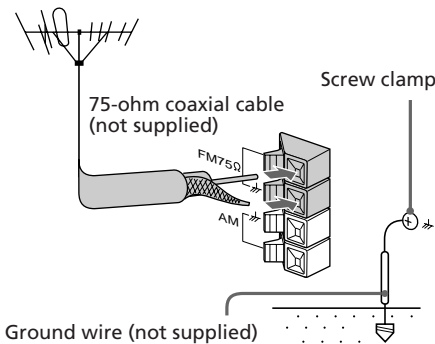

#### AM antenna

Connect a 6 to 15 meter (20 to 50 feet) insulated wire to the AM antenna terminal. Leave the supplied AM loop antenna connected.

##### For European model

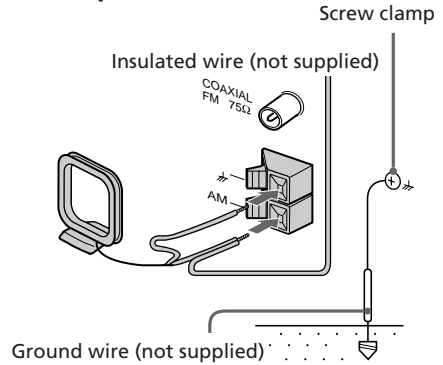

##### For other models

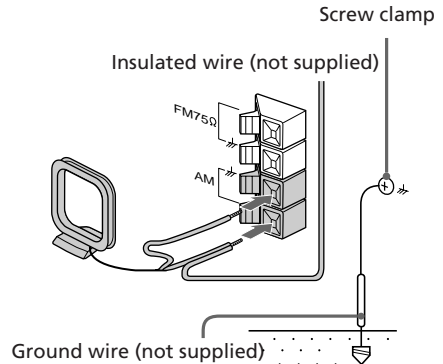

#### Important

If you connect an outdoor antenna, connect a ground wire to the ⚡ terminal with the screw clamp. To prevent a gas explosion, do not connect the ground wire to a gas pipe.

## Playing a CD

### — Normal Play

You can play up to five CDs in a row.

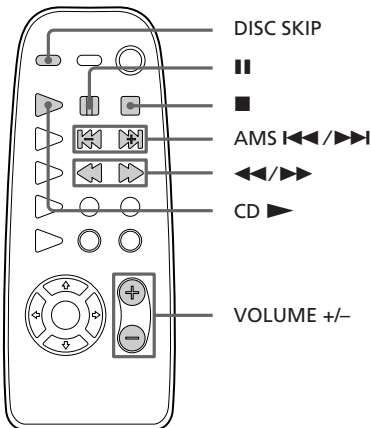
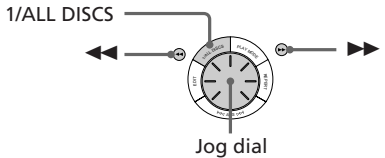
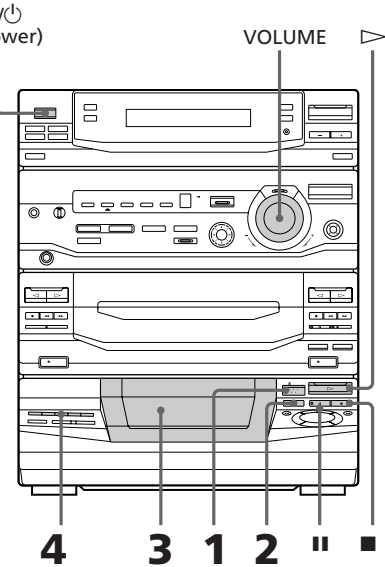

- 1 Press **▲ OPEN** and place a CD on the disc tray.  
If the disc is not placed properly it will not be recognized.

With the label side up. When you play a CD single, place it on the inner circle of the tray.

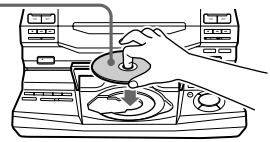

- 2 Press **DISC SKIP** to place up to four more CDs on the tray.  
The disc tray rotates so you can insert other CDs.

- 3 Close the front cover.

- 4 Press one of the **DIRECT PLAY** buttons.  
Playback starts.  
If you press **▷** (or **CD ▷** on the remote), playback starts from the CD in the playing position.

**LBT-D390/D790/G5500/XB33/XB33K/XB44/XB44K/XB50/XB60**

Disc number in the playing position  
Track number

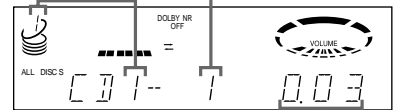

Elapsed time

**LBT-XB66/XB66K/XB660**

Disc number in the playing position

Track number



Elapsed time

continued

## Playing a CD (continued)

To	Do this
Stop playback	Press ■.
Pause	Press ■■. Press again to resume playback.
Select a track	During playback or pause, turn the jog dial clockwise (to go forward) or counterclockwise (to go backward) and release it when you reach the desired track. Or press AMS* ►► (to go forward) or AMS* ◄◄ (to go backward) on the remote.
Find a point in a track	Press and hold ►► or ◄◄ during playback, and release at the desired point.
Select a CD	Press one of the DIRECT PLAY buttons (or DISC SKIP).
Play only the CD you have selected	Press 1/ALL DISCS repeatedly until "1 DISC" appears.
Play all CDs	Press 1/ALL DISCS repeatedly until "ALL DISCS" appears.
Remove or change the CDs	Press ▲ OPEN.
Adjust the volume	Turn VOLUME (or press VOLUME +/- on the remote).

\* AMS: Automatic Music Sensor.

### Tips

- Pressing ▷ while the system power is off automatically turns on the system and starts CD playback if there is a CD on the tray (One Touch Play).
- You can switch from another source to the CD player and start playing a CD just by pressing ▷ or one of the DIRECT PLAY buttons (Automatic Source Selection).
- If there is no CD in the player, "NO DISC" appears in the display.
- You can change the CD in the loading position during playback.

# Recording a CD

## — CD Synchro Recording

This function lets you record from a CD to a tape easily. You can use TYPE I (normal) or TYPE II (CrO<sub>2</sub>) tapes. The recording level is adjusted automatically.

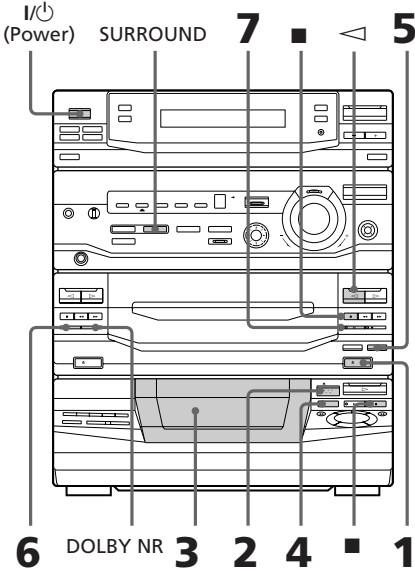

**1** Press **▲** EJECT and insert a blank tape into deck B.

With the side you want to record on facing forward

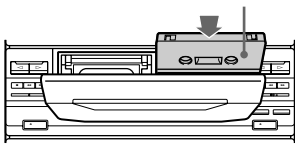

**2** Press **▲** OPEN and place a CD.

With the label side up. When you play a CD single, place it on the inner circle of the tray.

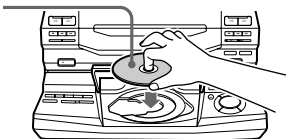

**3** Close the front cover.

**4** Press DISC SKIP repeatedly until the disc number you want to record appears in the playing position indicator.

**5** Press CD SYNC.

Deck B stands by for recording and the CD player stands by for playback, and the indicator on the **▷** button (for the front side) lights up green.

**6** Press DIRECTION repeatedly to select **↔** to record on one side or **↔↔** (or RELAY) to record on both sides.

**7** Press **||** on deck B. Recording starts.

### To stop recording

Press **■** on deck B or on the CD player.

### Tips

- If you want to record on the reverse side, press **◁** so the indicator on the **◁** button (for the reverse side) lights up green.
- When you record on both sides, be sure to start from the front side. If you start from the reverse side, recording stops at the end of the reverse side.
- When you want to reduce the hiss noise in low-level high-frequency signals, press DOLBY NR before step 7 so "DOLBY NR B" appears in the display.
- To record with the surround effect, press SURROUND so "SUR (|||||)" appears in the display. The equalizer settings will not be recorded.

### Note

You cannot listen to other sources while recording.

# Listening to the radio

## — Preset Tuning

Before using this function, preset radio stations in the tuner's memory (see "Step 3: Presetting radio stations").

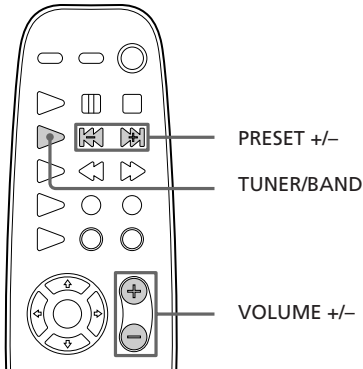
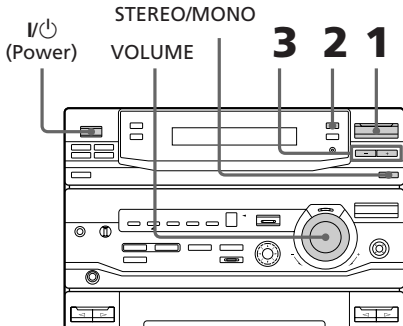

**1** Press TUNER/BAND repeatedly until the band you want appears in the display.

Each time you press this button, the band changes as follows:

2 band model:

FM ↔ AM

3 band model:

FM → MW → LW

↑

4 band model:

FM → MW → LW → UKV\*

↑

\* When you select this band, "STEREO Plus" appears in the display.

**2** Press TUNING MODE repeatedly until "PRESET" appears in the display.

MANUAL → AUTO → PRESET



**3** Press TUNING +/- (or PRESET +/- on the remote) to tune in the desired preset station.

LBT-D390/D790/G5500/XB33/XB33K/XB44/XB44K/XB50/XB60

Preset number

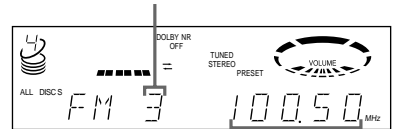

LBT-XB66/XB66K/XB660

Frequency

Preset number



Frequency

To	Do this
Turn off the radio	Press I/⏻.
Adjust the volume	Turn VOLUME (or press VOLUME +/- on the remote).

## To listen to non-preset radio stations

Press TUNING MODE repeatedly in step 2 until "MANUAL" appears, then press TUNING +/- to tune in the desired station.

### Tips

- Pressing TUNER/BAND while the system power is off automatically turns on the system and tunes to the last received station (One Touch Play).
- You can switch from another source to the radio just by pressing TUNER/BAND (Automatic Source Selection).
- If an FM program is noisy, press STEREO/MONO so "MONO" appears in the display. There will be no stereo effect, but the reception will improve. Press this button again to restore the stereo effect.
- To improve broadcast reception, move the supplied antennas.

# Recording from the radio

You can record a radio program on a tape by tuning in a preset station. You can use TYPE I (normal) or TYPE II (CrO<sub>2</sub>) tapes. The recording level is automatically adjusted.

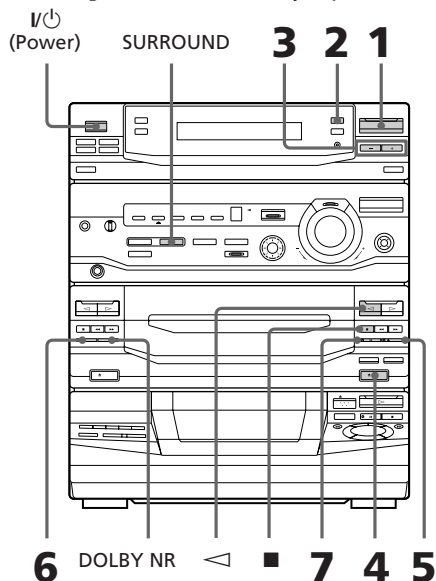

- 1 Press TUNER/BAND repeatedly until the band you want appears in the display.
- 2 Press TUNING MODE repeatedly until "PRESET" appears in the display.

- 3 Press TUNING +/- to tune in a preset station.

LBT-D390/D790/G5500/XB33/XB33K/XB44/XB44K/XB50/XB60

Preset number

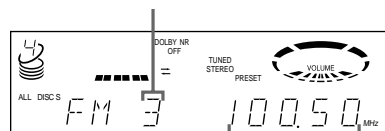

Frequency

LBT-XB66/XB66K/XB660

Preset number



Frequency

- 4 Press ▲ EJECT and insert a blank tape into deck B.

With the side you want to record on facing forward

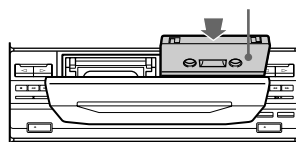

- 5 Press ● REC. Deck B stands by for recording, and the indicator on the ▷ button (for the front side) lights up green.
- 6 Press DIRECTION repeatedly to select ⇌ to record on one side or ↔ (or RELAY) to record on both sides.
- 7 Press || on deck B. Recording starts.

## To stop recording

Press ■ on deck B.

continued

## Recording from the radio (continued)

### Tips

- If you want to record on the reverse side, press ◀ so the indicator on the ◀ button (for the reverse side) lights up green after pressing ● REC in step 5.
- When you record on both sides, be sure to start from the front side. If you start from the reverse side, recording stops at the end of the reverse side.
- To record non-preset stations, select "MANUAL" in step 2, then press TUNING +/- to tune in the desired station.
- When you want to reduce the hiss noise in low-level high-frequency signals, press DOLBY NR before step 7 so "DOLBY NR B" appears in the display.
- To record with surround effect, press SURROUND so "SUR ((||||))" appears in the display.  
The equalizer settings will not be recorded.
- If noise is heard while recording from the radio, move the appropriate antenna to reduce the noise.

## Playing a tape

You can play any type of tape, TYPE I (normal), TYPE II (CrO<sub>2</sub>) or TYPE IV (metal). The deck automatically detects the tape type. To select either deck A or B, press DECK A ▶ or DECK B ▶ on the remote.

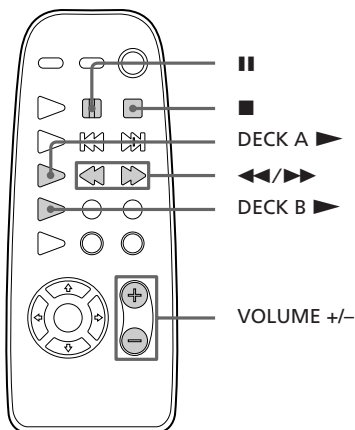
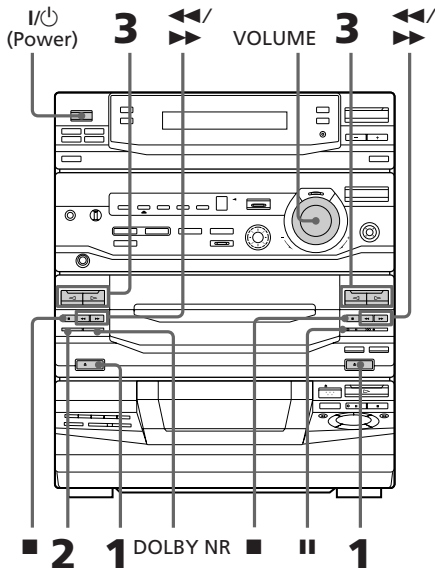



- 1 Press **EJECT** and insert a recorded tape in deck A or B.

With the side you want to play facing forward

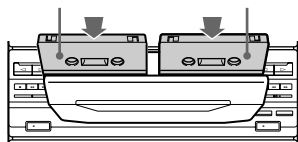

- 2 Press **DIRECTION** repeatedly to select **→** to play one side, **↔**\* to play both sides, or **RELAY** (Relay Play)\*\* to play both decks in succession.

- 3 Press **▷**. Press **◁** to play the reverse side. The tape starts playing.

\* The deck stops automatically after playing both sides five times.

\*\* Relay Play always plays according to the following sequence:

Deck A (front side), Deck A (reverse side), Deck B (front side), Deck B (reverse side).

To	Do this
Stop play	Press <b>■</b> .
Pause (Deck B only)	Press <b>⏸</b> . Press again to resume play.
Fast-forward	Press <b>▶▶</b> while playing the front side or <b>◀◀</b> while playing the reverse side.
Rewind	Press <b>◀◀</b> while playing the front side or <b>▶▶</b> while playing the reverse side.
Remove the cassette	Press <b>EJECT</b> .
Adjust the volume	Turn <b>VOLUME</b> (or press <b>VOLUME +/-</b> on the remote).

### Tips

- Pressing **▷** or **◁** while the system power is off automatically turns on the system and starts tape playback if there is a tape in the deck (One Touch Play).
- You can switch from another source to the tape deck just by pressing **▷** or **◁** (Automatic Source Selection).
- When you want to reduce the hiss noise in low-level high-frequency signals, press **DOLBY NR** so "DOLBY NR B" appears in the display.

# Recording from a tape

## — High-speed Dubbing

You can use TYPE I (normal) or TYPE II (CrO<sub>2</sub>) tapes. The recording level is automatically adjusted.

⏻  
(Power)

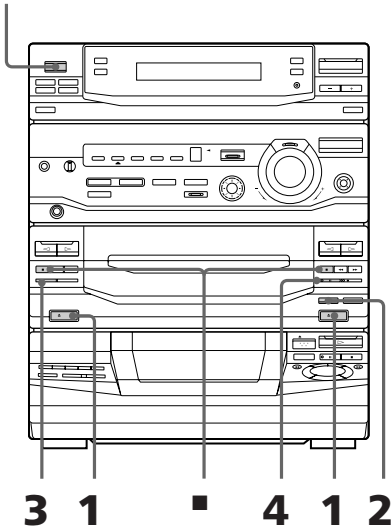

- 1 Press **▲** EJECT and insert a recorded tape in deck A and a blank tape in deck B.

With the side you want to play/record on facing forward

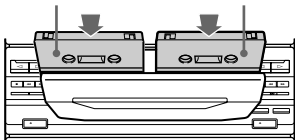

- 2 Press **H SPEED DUB**.  
Deck B stands by for recording.

- 3 Press **DIRECTION** repeatedly to select **↔** to record on one side or **↔↔** to record on both sides.

- 4 Press **II**.

Dubbing starts.

When dubbing ends, decks A and B automatically stop.

### To stop dubbing

Press **■** on deck A or B.

### Tips

- When you dub on both sides, start recording from the front side. If you start from the reverse side, recording stops at the end of the reverse side.
- You don't have to set DOLBY NR, since the tape in deck B is automatically recorded in the same state as the tape in deck A.

### Notes

- If you set **DIRECTION** to **↔↔** when the tapes you use have different lengths, the tape in each deck reverses independently. If you want to start dubbing from the same point for the other side, set **DIRECTION** to **↔** and reverse tapes manually after both decks stop. Then press **H SPEED DUB** again to start recording the other side.
- You cannot record the surround effect.

## Using the CD display

You can check the remaining time of the current track or the whole CD.

DISPLAY/DEMO

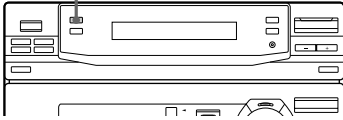

➔ Press DISPLAY/DEMO during playback.

Each time you press this button in Normal Play, the display changes as follows:

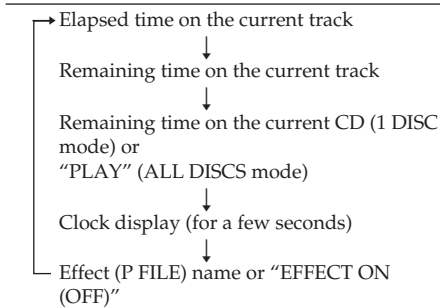

### To check the total playing time and the number of tracks on a CD

Press DISPLAY/DEMO in stop mode.

If you press DISPLAY/DEMO again, the clock display appears for a few seconds then the display returns to the previous indication.

## Playing CD tracks repeatedly

### — Repeat Play

This function lets you repeat a single CD or all CDs in Normal Play, Shuffle Play, and Program Play.

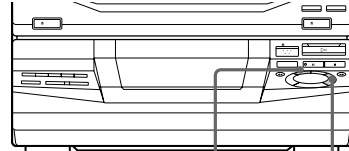

1/ALL DISCS REPEAT

➔ Press REPEAT repeatedly during playback until “REPEAT” appears in the display.

Repeat Play starts. The following table describes the various repeat modes.

To repeat	Press
All the tracks on the current CD	1/ALL DISCS repeatedly until “1 DISC” appears in the display.
All the tracks on all CDs	1/ALL DISCS repeatedly until “ALL DISCS” appears in the display.
Only one track*	REPEAT repeatedly while playing the track you want to repeat until “REPEAT 1” appears in the display.

\* You can't repeat a single track during Shuffle Play and Program Play.

### To cancel Repeat Play

Press REPEAT repeatedly until “REPEAT” or “REPEAT 1” disappears from the display.

---

# Playing CD tracks in random order

## — Shuffle Play

You can play all the tracks on one CD or all the CDs in random order.

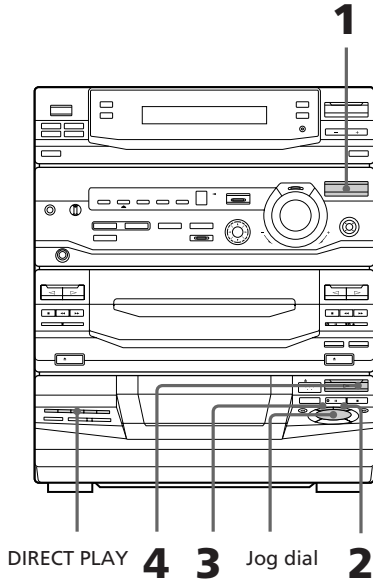

### To cancel Shuffle Play

Press PLAY MODE repeatedly until "SHUFFLE" or "PROGRAM" disappears from the display. The tracks continue playing in their original order.

### To select a desired CD

Press one of the DIRECT PLAY buttons during 1 Disc Shuffle Play.

### Tips

- You can start Shuffle Play during Normal Play by pressing PLAY MODE repeatedly until "SHUFFLE" appears in the display.
- To skip a track, turn the jog dial clockwise (or press AMS ►► on the remote).

---

**1** Press FUNCTION repeatedly until "CD" appears in the display.

---

**2** Press PLAY MODE repeatedly until "SHUFFLE" appears in the display.

---

**3** Press 1/ALL DISCS to choose "1 DISC" or "ALL DISCS."  
"ALL DISCS" shuffles the tracks on all the CDs in the player. "1 DISC" shuffles the tracks on the CD in the playing position.

---

**4** Press ▷.  
"▷" appears and all the tracks play in random order.

---

# Programming CD tracks

## — Program Play

You can create a program of up to 32 tracks from all the CDs in the order you want them to be played.

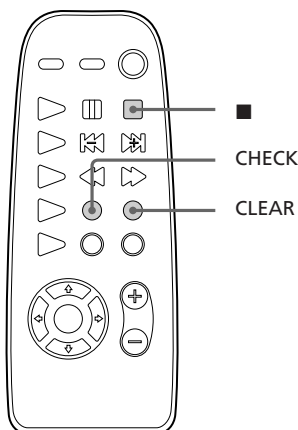
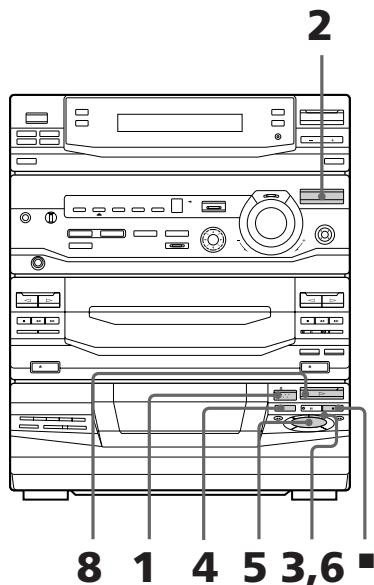

**1** Place CDs and close the front cover.

**2** Press **FUNCTION** repeatedly until “CD” appears in the display.

**3** Press **PLAY MODE** repeatedly until “PROGRAM” appears in the display.

**4** Press **DISC SKIP** to select a CD.

**5** Turn the jog dial until the desired track appears in the display.

**LBT-D390/D790/G5500/XB33/XB33K/XB44/XB44K/XB50/XB60**

Disc number

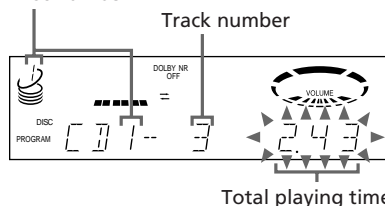

**LBT-XB66/XB66K/XB660**

Disc number

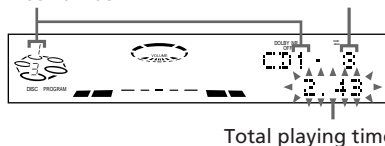

**6** Press **PLAY MODE** once.

The track is programmed. “STEP” and the programmed playing order appear, followed by the total playing time.

**LBT-D390/D790/G5500/XB33/XB33K/XB44/XB44K/XB50/XB60**

The last programmed track

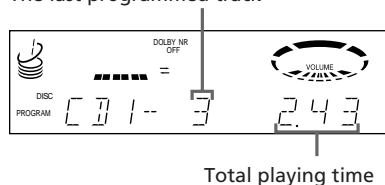

**LBT-XB66/XB66K/XB660**

The last programmed track



Total playing time

## Programming CD tracks (continued)

**7** Repeat steps 4 through 6 to program additional tracks.  
Skip step 4 to select tracks from the same disc.

**8** Press  $\triangleright$ .  
All the tracks play in the order you selected.

### To cancel Program Play

Press PLAY MODE repeatedly until "PROGRAM" or "SHUFFLE" disappears from the display.

To	Press
Check the program	CHECK on the remote repeatedly. After the last track, "CHECK END" appears.
Clear the last selected track	CLEAR on the remote in stop mode.
Clear a specific track	CHECK on the remote repeatedly until the number of the track to be cleared lights up, then press CLEAR.
Add a track to the program	1 Press DISC SKIP to select a CD. 2 Turn the jog dial to select a track. 3 Press PLAY MODE.
Clear the entire program	■ once in stop mode or twice while playing.

### Tips

- The program you created remains in the CD player's memory even after it has been played. Press  $\triangleright$  to play the same program again.
- If "--:--" appears instead of the total playing time while programming, this means:
  - you have programmed a track numbered over 20, or
  - the total playing time has exceeded 100 minutes.

## Playing CDs without interruption

### — Non-Stop Play

You can play CDs without pausing between tracks.

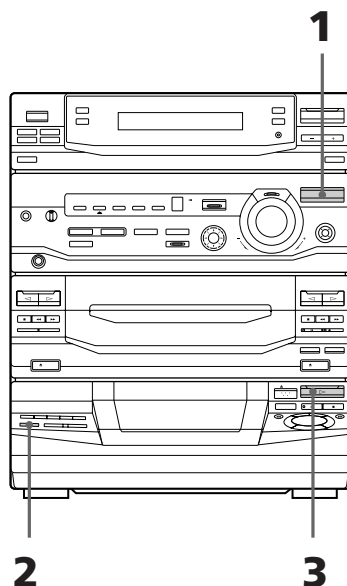

**1** Press FUNCTION repeatedly until "CD" appears in the display.

**2** Press NON-STOP so the indicator on this button lights up.

**3** Press  $\triangleright$ .

### To cancel Non-Stop Play

Press NON-STOP so the indicator on this button goes off.

## Recording on a tape manually

You can record from CDs, tapes, or the radio as you like. For example, you can record just the songs you want or begin recording from the middle of the tape. The recording level is adjusted automatically.

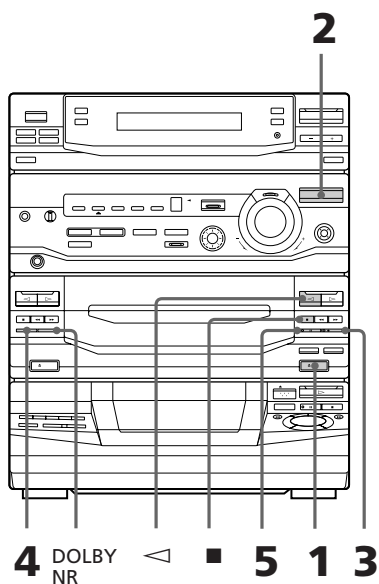

- 1** Insert a blank tape into deck B.
- 2** Press FUNCTION repeatedly until the source you want to record (e.g., CD) appears in the display.
- 3** Press ● REC.  
Deck B stands by for recording, and the indicator on the ▷ button (for the front side) lights up green.
- 4** Press DIRECTION repeatedly to select ↔ to record on one side or ⇄ (or RELAY) to record on both sides.

- 5** Press || on deck B.  
Recording starts.
- 6** Start playing the source to be recorded.

To	Press
Stop recording	■ on deck B
Pause recording	on deck B

### Tips

- If you want to record on the reverse side, press ◀ so the indicator on the ◀ button (for the reverse side) lights up green.
- When you want to reduce the hiss noise in low-level high-frequency signals, press DOLBY NR before step 5 so "DOLBY NR B" appears in the display.

# Recording CDs by specifying the track order

## — Program Edit

You can record tracks from all the CDs in the order you want. When programming, make sure the playing times for each side do not exceed the length of one side of the tape.

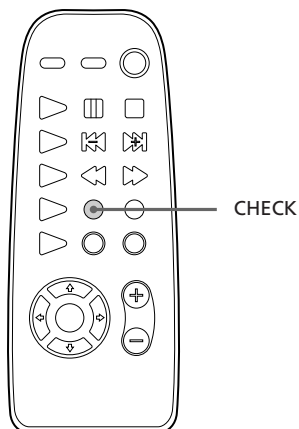
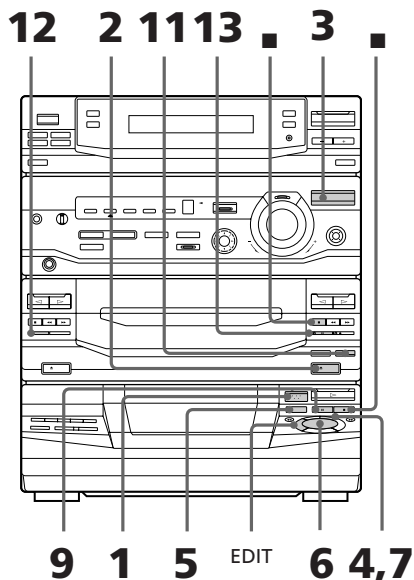

- 1 Place CDs and close the front cover.
- 2 Insert a blank tape into deck B.
- 3 Press FUNCTION repeatedly until "CD" appears in the display.
- 4 Press PLAY MODE repeatedly until "PROGRAM" appears in the display.
- 5 Press DISC SKIP to select a CD.
- 6 Turn the jog dial until the desired track appears in the display.

LBT-D390/D790/G5500/XB33/XB33K/XB44/  
XB44K/XB50/XB60

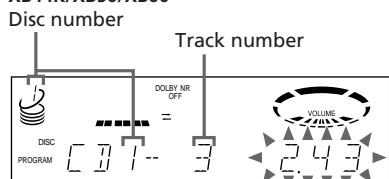

Total playing time  
(including selected track)

LBT-XB66/XB66K/XB660

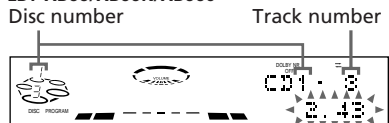

Total playing time  
(including selected track)



---

## 7 Press PLAY MODE once.

The track is programmed. "STEP" and the programmed playing order appear, followed by the total playing time.

LBT-D390/D790/G5500/XB33/XB33K/XB44/  
XB44K/XB50/XB60

The last programmed track

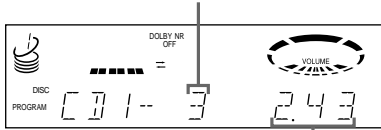

Total playing time

LBT-XB66/XB66K/XB660

The last programmed track

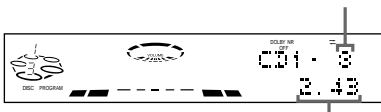

Total playing time

---

## 8 Repeat steps 5 through 7 to program additional tracks to be recorded on side A.

Skip step 5 to select tracks from the same disc.

---

## 9 Press II to insert a pause at the end of side A.

"P" appears in the display and the total playing time resets to "0.00" in the display.

---

## 10 Repeat steps 5 through 7 to program the tracks to be recorded on side B.

Skip step 5 to select tracks from the same disc.

---

## 11 Press CD SYNC.

Deck B stands by for recording, the CD player stands by for playback, and the indicator on the > button (for the front side) lights up green.

---

## 12 Press DIRECTION repeatedly to select ⇌ to record on one side or ⇄ (or RELAY) to record on both sides.

---

## 13 Press II on deck B.

Recording starts.

---

### To stop recording

Press ■ on deck B or on the CD player.

### To check the order

Press CHECK on the remote repeatedly. After the last track, "CHECK END" appears.

### To cancel Program Edit

Press PLAY MODE repeatedly until "PROGRAM" or "SHUFFLE" disappears from the display.

---

## Selecting the tape length automatically

### — Tape Select Edit

You can check the most suitable tape length for recording a CD. Note that you cannot use Tape Select Edit for discs containing more than 20 tracks.

---

➔ After inserting a CD, press EDIT once so "EDIT" flashes.

The required tape length for the CD in the playing position appears, followed by the total playing time for sides A and B.

---

### Note

You cannot use this function when Program Play mode has been set. After clearing the entire program (see "Clear the entire program" in the table on page 22), follow the above procedure.

## Looping part of a CD

### — Loop

With the loop function, you can repeat part of a CD during playback. This lets you create original recordings.

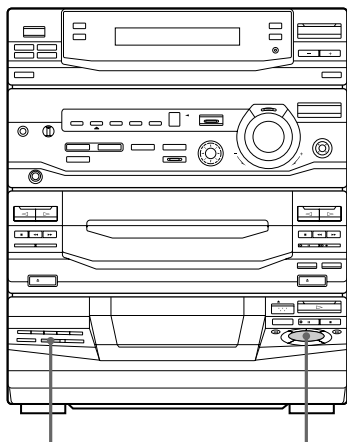

LOOP

Jog dial

➔ Press and hold LOOP during playback at the point you want to start the Loop function, and release to resume normal playback.

### To adjust the loop length

Turn the jog dial while holding LOOP (or press MUSIC MENU ◀/▶ while holding LOOP on the remote) to select different loop lengths.

## Flashing part of a CD

### — Flash

With the flash function, you can “flash” the CD sound during playback. This lets you create original recordings.

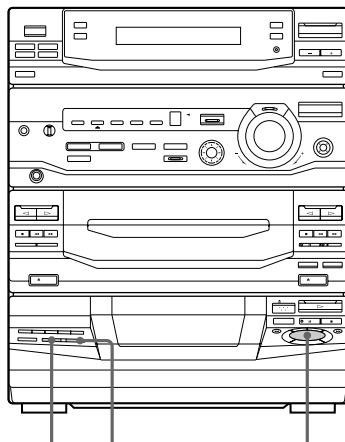

LOOP FLASH

Jog dial

➔ Press and hold FLASH during playback at the point you want to start the Flash function, and release to resume normal playback.

### To adjust the flash length

Turn the jog dial while holding FLASH (or press MUSIC MENU ◀/▶ while holding FLASH on the remote) to select different flash lengths.

### To use LOOP and FLASH together

Press and hold both LOOP and FLASH at the same time.

### Note

The loop and flash length cannot be adjusted in stop mode. Adjust the loop and flash lengths during operation.

---

# Waving the equalizer

## — Wave

With the Wave function, you can fluctuate the graphic equalizer automatically while listening to a source. This effect can be used with any source, but it cannot be recorded.

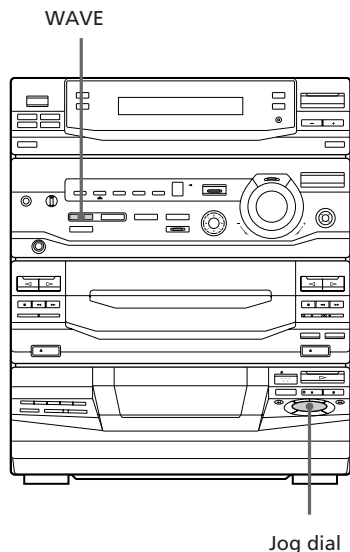

- 
- ➔ Press and hold WAVE while listening to a source at the point you want to start the Wave function, and release to resume normal playback.
- 

### To adjust the wave length

Turn the jog dial while holding WAVE to select different wave lengths.

## Adjusting the sound

You can reinforce the bass, create a more powerful sound, and listen with headphones.

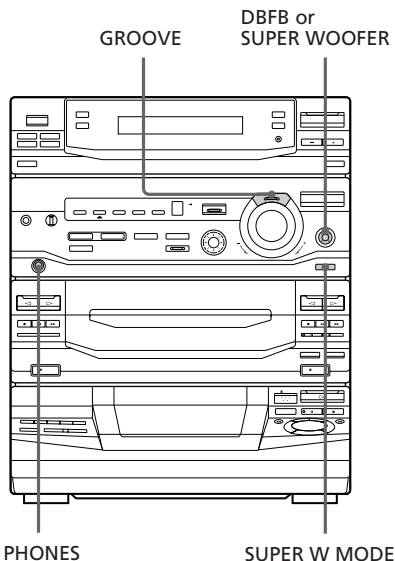

### To reinforce the bass (DBFB) (LBT-D390/G5500/XB33/XB33K/XB50 only)

Press DBFB.\*

Each time you press this button, the DBFB level display changes as follows:

DBFB ███ → DBFB █████ → display off

"DBFB █████" reinforces the bass more than "DBFB ███".

\* DBFB = Dynamic Bass Feedback

### To reinforce the bass from the super woofer (SUPER WOOFER) (except for LBT-D390/G5500/XB33/XB33K/XB50)

Press SUPER WOOFER.

Each time you press this button, the super woofer level display changes as follows:

SUPER WOOFER FLAT → LOW → HIGH

### To select the super woofer mode (except for LBT-D390/G5500/XB33/XB33K/XB50)

Press SUPER W MODE while the super woofer is on.

Each time you press this button, the super woofer mode display changes as follows:

MOVIE ↔ MUSIC

### For a powerful sound (GROOVE)

Press GROOVE.

The volume switches to power mode, the equalizer curve changes, the bass level (DBFB or SUPER WOOFER) changes to "HIGH," and the indicator on the GROOVE button lights up. Press GROOVE again to return to the previous volume.

### Notes

- The music sound will be distorted when you use the DBFB system with the graphic equalizer if the bass is too strong. Adjust the bass slowly while listening to the music so you can monitor the effect of the adjustment.
- Canceling GROOVE cancels the equalizer curve and bass level. Adjust the equalization to obtain the effect you desire.

### To listen through the headphones

Connect the headphones to the PHONES jack.

No sound will come from the speakers.



# Adjusting the audio emphasis

You can adjust the audio emphasis using the graphic equalizer and surround effect.

## Adjusting the graphic equalizer

You can adjust the sound by raising or lowering the levels of specific frequency ranges.

Before operation, first select the basic audio emphasis you want for your sound.

**6 2 3,4**

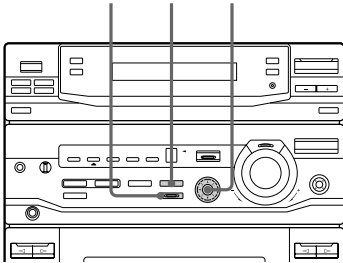

- 1** Select the basic audio emphasis you want for your sound (see "Selecting the audio emphasis").
- 2** Press GEQ CONTROL.  
The frequency range appears and the level value flashes in the display.
- 3** Press GEQ  $\leftarrow/\rightarrow$  repeatedly to select a frequency band.

LBT-D390/D790/G5500/XB33/XB33K/XB44/XB44K/XB50/XB60

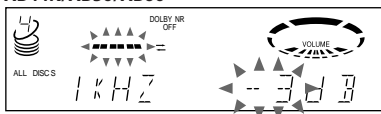

LBT-XB66/XB66K/XB660



- 4** Press GEQ  $\uparrow/\downarrow$  to adjust the level.

LBT-D390/D790/G5500/XB33/XB33K/XB44/XB44K/XB50/XB60

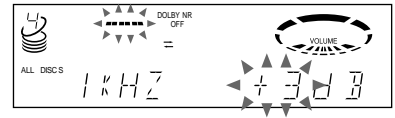

LBT-XB66/XB66K/XB660



- 5** Repeat steps 3 and 4 to adjust the other frequency bands.

- 6** Press ENTER when finished.

### Note

If you choose another audio emphasis (other than "EFFECT OFF"), the adjusted sound effect is lost. To retain the adjusted sound effect for future use, store it in a personal file (see "Making a personal audio emphasis file").

## Activating the surround effect

You can enjoy the surround effect.

SURROUND

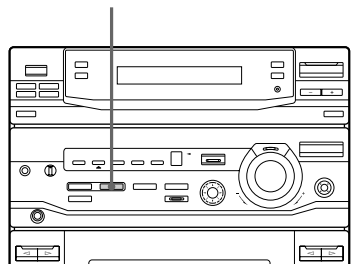

- Press SURROUND so "SUR ((|||||))" appears in the display.

### Note

If you choose other sound effects, the surround effect will be canceled. To retain the effect, store it in a personal file (see "Making a personal audio emphasis file").

# Making a personal audio emphasis file

## — Personal File

You can create personal files of audio patterns (surround effect and graphic equalizer) and store them in the unit's memory. Later call up an audio pattern to play a favorite tape, CD, or radio program. You can create up to five audio files. Before operation, first select the basic audio emphasis you want for your sound.

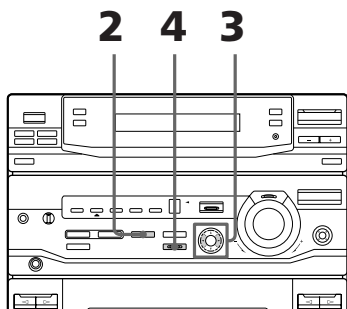

**1** Create the sound effect you want by using the graphic equalizer and surround effect (see “Adjusting the audio emphasis”).

**2** Press P FILE MEMORY.  
A personal file number appears in the display.

LBT-D390/D790/G5500/XB33/XB33K/XB44/  
XB44K/XB50/XB60

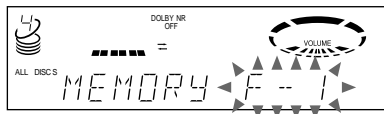

LBT-XB66/XB66K/XB660



**3** Press GEQ  $\leftarrow/\rightarrow$  to select the file number (P FILE) where you want to store the sound effect.

**4** Press ENTER.

The adjusted sound effects are stored under the selected file number. Any settings previously stored at this memory location are erased and replaced by the new settings.

## To call up the personal file

- 1 Press GEQ  $\uparrow/\downarrow$  (or MUSIC MENU  $\uparrow/\downarrow$  on the remote) repeatedly to display the last selected personal file.
- 2 Press GEQ  $\leftarrow/\rightarrow$  (or MUSIC MENU  $\leftarrow/\rightarrow$  on the remote) repeatedly to select the desired personal file.

## Using the Radio Data System (RDS) (For European model only)

### What is the Radio Data System?

The Radio Data System (RDS) is a broadcasting service that allows radio stations to send additional information along with the regular program signal. This tuner offers convenient RDS features, such as monitoring traffic, news, or information programs and locating a station by program type. RDS is available only on FM stations.\*

#### Note

RDS may not work properly if the station you are tuned to is not transmitting the RDS signal properly or if the signal strength is weak.

\* Not all FM stations provide RDS service, nor do they provide the same types of services. If you are not familiar with the RDS system, check with your local radio stations for details on RDS services in your area.

### Receiving RDS broadcasts

➔ Simply select a station from the FM band.

When you tune in a station that provides RDS services, the station name appears in the display.

#### To check the RDS information

Each time you press DISPLAY/DEMO, the display changes as follows:

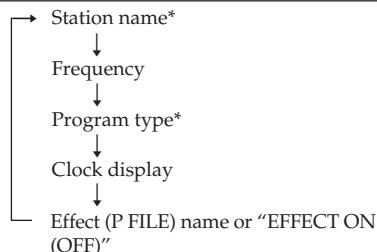

\* If the RDS broadcast is not received, the station name and the program type may not appear in the display.

### Locating a station by program type (PTY)

You can locate the station you want by selecting a program type. The unit tunes in that type of program currently being broadcast from the RDS stations stored in the tuner's preset memory.

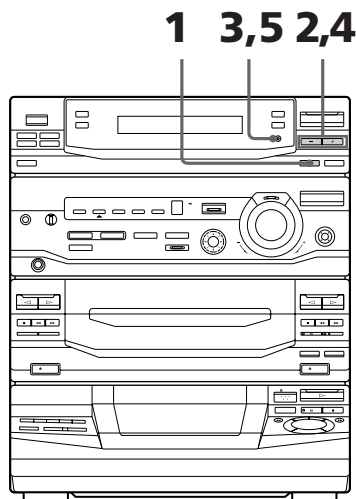

**1** Press PTY.

**2** Press TUNING +/- to select the program type you want. See the "List of program types (PTY)" section below.

**3** Press ENTER/NEXT.

The unit starts searching for the preset RDS stations ("SEARCH" and the selected program type appear alternately in the display).

When the tuner receives a program, the preset station number flashes.

**4** Press TUNING +/- until the desired preset station number flashes in the display.

**5** Press ENTER/NEXT while the preset station number is flashing.



---

**To stop the search while it is in progress**

Press PTY.

---

**List of program types (PTY)**

---

**AFFAIRS**

Topical programs that expand on current news topics.

---

**ALARM**

Emergency broadcasts.

---

**CULTURE**

Programs about national or regional culture.

---

**DRAMA**

Radio plays and serials.

---

**EDUCATE (Education)**

Educational programs, such as “how-to” programs and advice.

---

**INFO (Information)**

Programs about consumer affairs, medical advice, and weather.

---

**LIGHT MUSIC**

Classical music, such as instrumentals, vocal, and choral works.

---

**M.O.R. MUSIC**

Easy listening (middle of the road) music.

---

**NEWS**

News programs.

---

**OTHER MUSIC**

Music, such as jazz, rhythm and blues, and reggae.

---

**POP MUSIC**

Popular music programs.

---

**ROCK MUSIC**

Rock music programs.

---

**SCIENCE**

Programs about the natural sciences

---

**CLASSICS**

Performances of major orchestras, chamber music, opera, etc.

---

**SPORT**

Sports programs.

---

**VARIED**

Programs containing celebrity interviews, panel games, and comedy.

---

**NONE**

Any programming not defined above.

---

**Note**

“NO PTY” appears when the program type you selected is not currently being broadcasted.

# Singing along: Karaoke

You can sing along with any stereo CD or tape by turning down the singer's voice. You need to connect an optional microphone.

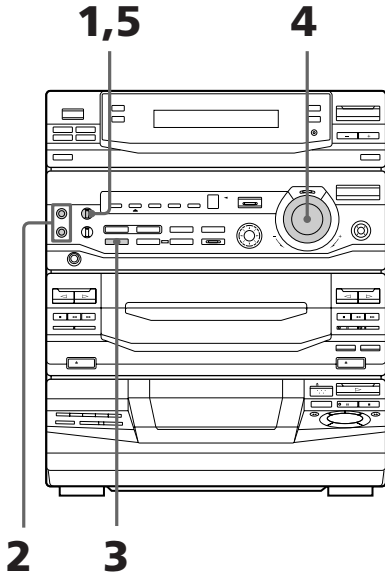

- 1** Turn MIC LEVEL to MIN to turn down the microphone level.
- 2** Connect an optional microphone to the MIC (MIC 1\*) jack.  
When you use two microphones at the same time, connect the other one to the MIC 2\* jack.  
(\* LBT-XB33K/XB44K/XB66K only)
- 3** Press KARAOKE PON/MPX repeatedly to obtain the desired karaoke effect.  
Each time you press this button, the display changes as follows:  
KARAOKE PON → MPX R → MPX L  
↑ EFFECT OFF (ON) ↓  
“🎤” appears in the display when the karaoke mode is activated.

To	Select
Reduce the singer's voice on a CD or tape	KARAOKE PON
Reduce the left channel on a multiplex CD or tape	MPX R
Reduce the right channel on a multiplex CD or tape	MPX L

- 4** Start playing the music and adjust the volume.
- 5** Turn MIC LEVEL to adjust the microphone volume.

## When you are done

Turn MIC LEVEL to MIN and disconnect the microphone from MIC, then press KARAOKE PON/MPX repeatedly until “🎤” disappears from the display.

## Adjusting the microphone echo

(LBT-XB33K/XB44K/XB66K only)

ECHO LEVEL

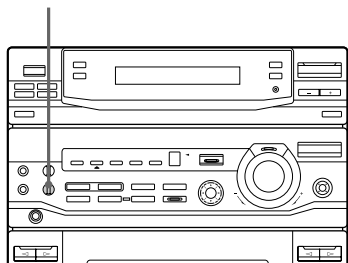

➔ Turn ECHO LEVEL to adjust the echo effect.

### To cancel the echoing

Turn ECHO LEVEL to MIN.

## Adjusting the key

(LBT-XB33K/XB44K/XB66K only)

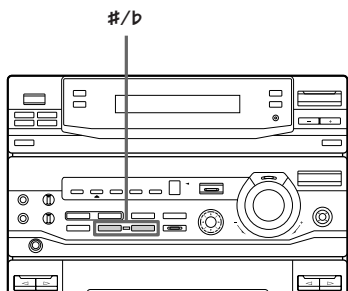

➔ Press **b** or **#**.

You can adjust the key higher or lower in 13 halftone steps (-3.0 to 3.0).

## Mixing and recording sounds

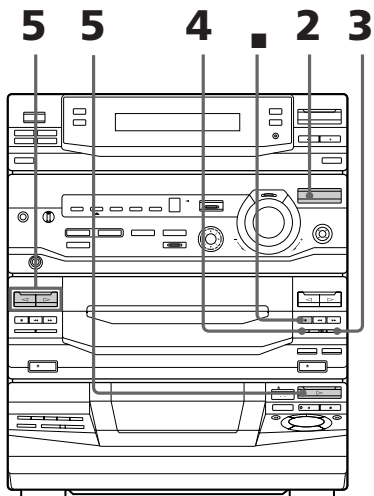

- 1** Prepare the microphone and the karaoke effect. Then, insert a blank tape in deck B.
- 2** Press FUNCTION repeatedly to select the source you desire and set it to pause mode.
- 3** Press ● REC.
- 4** Press II.
- 5** Press ▷ to start playing the CD (or tape in deck A). Playback starts. Start singing along with the music.

### To stop recording

Press ■ on deck B.



# Waking up to music

## — Wake-up Timer

You can wake up to music at a preset time every day. Make sure you have set the clock (see "Step 2: Setting the time").

The 24-hour system model is used for illustration purpose.

**9 3 4,5,6,7,8**

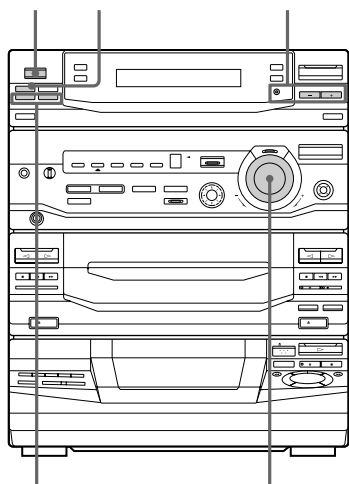

DAILY 1/DAILY 2

**2**

**1** Prepare the music source you want to play.

- CD: Insert a CD. To start from a specific track, create a program (see "Programming CD tracks").
- Tape: Insert a tape with the side you want to play facing forward.
- Radio: Tune in the preset station you want (see "Step 3: Presetting radio stations").

**2** Turn VOLUME to adjust the volume.

**3** Press  $\odot$ /CLOCK SET.  
"SET" appears and "DAILY 1" flashes in the display.

**4** Press TUNING +/- to select DAILY 1 or DAILY 2, then press ENTER/NEXT.

"ON" appears and the hour indication flashes in the display.

**LBT-D390/D790/G5500/XB33/XB33K/XB44/XB44K/XB50/XB60**

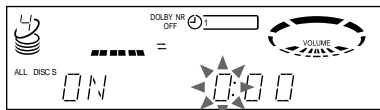

**LBT-XB66/XB66K/XB660**



**5** Set the time to start playback.

Press TUNING +/- to set the hour, then press ENTER/NEXT.

The minutes indication flashes.

**LBT-D390/D790/G5500/XB33/XB33K/XB44/XB44K/XB50/XB60**

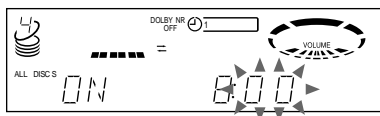

**LBT-XB66/XB66K/XB660**



Press TUNING +/- to set the minutes, then press ENTER/NEXT.

The hour indication flashes again.

**6** Set the time to stop playback following the above procedure.

**7** Press TUNING +/- until the music source you want appears.

The indication changes as follows:

TUNER → CD PLAY → TAPE PLAY



**8** Press ENTER/NEXT.

The start time, the stop time, and the music source appear in turn before the original display returns.

continued

---

**9** Turn off the system.

---

**To check the setting**

- 1 Press the timer button you have set, DAILY 1 or DAILY 2.
- 2 "TIMER OFF" appears in the display.
- 3 Press DAILY 1 or DAILY 2 again.

**To cancel the timer operation**

- 1 Press the timer button you have set, DAILY 1 or DAILY 2.
- 2 "TIMER OFF" appears in the display.

**Notes**

- The system turns on 15 seconds before the preset time.
- You cannot activate DAILY 1 and DAILY 2 at the same time.
- You cannot set the timer if the timer on and off times are the same.
- When you set the Sleep Timer, the Wake-up Timer will not turn on the system until the Sleep Timer turns it off.
- You cannot activate the Wake-up Timer and Timer-recording at the same time.

---

## Timer-recording radio programs

To timer-record, you must preset the radio station (see "Step 3: Presetting radio stations") and set the clock (see "Step 2: Setting the time") beforehand.

**2 7 REC 6 3,4,5**

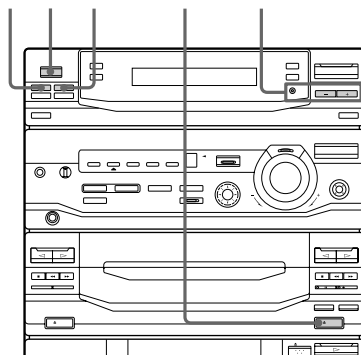

- 
- 1 Tune in the preset radio station (see "Listening to the radio").
  - 2 Press  $\ominus$ /CLOCK SET.  
"SET" appears and "DAILY 1" flashes in the display.
  - 3 Press TUNING +/- to select REC, then press ENTER/NEXT.  
"ON" appears and the hour indication flashes in the display.
- 

LBT-D390/D790/G5500/XB33/XB33K/XB44/XB44K/XB50/XB60

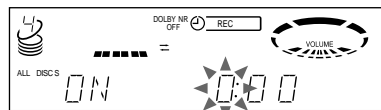

LBT-XB66/XB66K/XB660



- 
- 4** Set the time to start recording.  
Press TUNING +/- to set the hour, then press ENTER/NEXT.  
The minutes indication flashes.

LBT-D390/D790/G5500/XB33/XB33K/XB44/  
XB44K/XB50/XB60

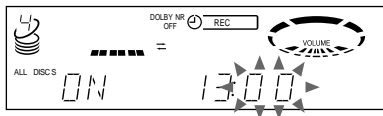

LBT-XB66/XB66K/XB660



Press TUNING +/- to set the minutes,  
then press ENTER/NEXT.  
The hour indication flashes again.

- 
- 5** Set the time to stop recording  
following the above procedure.  
The start time, the stop time, the  
recording source, and the preset station  
appear in turn before the original display  
returns.

- 
- 6** Insert a blank tape in deck B.

- 
- 7** Turn off the system.  
When recording starts, the volume level  
is set to the minimum.
- 

## To check the setting

- 1 Press REC.
  - 2 "TIMER OFF" appears in the display.
  - 3 Press REC again.
- To change the setting, start over from step 1.

## To cancel the timer operation

- 1 Press REC.
- 2 "TIMER OFF" appears in the display.

## Notes

- The system turns on 15 seconds before the preset time.
- If the system is on at the preset time, the recording will not be made.
- You cannot set the timer if the timer on and off times are the same.
- When you set the Sleep Timer, the Timer-recording will not start until the Sleep Timer turns off the system.
- You cannot activate the Wake-up Timer and Timer-recording at the same time.
- Recording starts from the front side.

## Precautions

### On operating voltage

Before operating the system, check that the operating voltage of your system is identical with the voltage of your local power supply.

### On safety

- The unit is not disconnected from the AC power source (mains) as long as it is connected to the wall outlet, even if the unit itself has been turned off.
- Unplug the system from the wall outlet (mains) if it is not to be used for an extended period of time. To disconnect the cord (mains lead), pull it out by the plug. Never pull the cord itself.
- Should any solid object or liquid fall into the component, unplug the stereo system and have the component checked by qualified personnel before operating it any further.
- The AC power cord must be changed only at the qualified service shop.

### On placement

- Place the stereo system in a location with adequate ventilation to prevent heat build-up in the stereo system.
- Do not place the unit in an inclined position.
- Do not place the unit in locations where it is;
  - Extremely hot or cold
  - Dusty or dirty
  - Very humid
  - Vibrating
  - Subject to direct sunlight

### On operation

- If the stereo system is brought directly from a cold to a warm location, or is placed in a very damp room, moisture may condense on the lens inside the CD player. Should this occur, the system will not operate properly. Remove the CD and leave the system turned on for about an hour until the moisture evaporates.
- When you move the system, take out any discs.

If you have any questions or problems concerning your stereo system, please consult your nearest Sony dealer.

### Notes on CDs

- Before playing, clean the CD with a cleaning cloth. Wipe the CD from the center out.
- Do not use solvents such as benzene, thinner, commercially available cleaners or anti-static spray intended for vinyl LPs.
- Do not expose the CD to direct sunlight or heat sources such as hot air ducts, nor leave it in a car parked in direct sunlight.

### Cleaning the cabinet

Use a soft cloth slightly moistened with mild detergent solution.

### To save a tape permanently

To prevent a tape from being accidentally recorded over, break off the cassette tab from side A or B as illustrated. If you later want to reuse the tape for recording, cover the broken tab with adhesive tape.

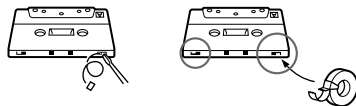

When you are using a TYPE II (CrO<sub>2</sub>) or TYPE IV (metal) cassette, be careful not to cover the detector slots which allow the tape player to automatically detect the type of tape.

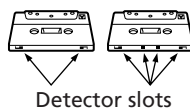

### Before placing a cassette in the tape deck

Take up any slack in the tape. Otherwise the tape may get entangled in the parts of the tape deck and become damaged.

### When using a tape longer than 90 minutes

The tape is very elastic. Do not change the tape operations such as play, stop, and fast-winding etc. frequently. The tape may get entangled in the tape deck.

### Cleaning the tape heads

Clean the tape heads after every 10 hours of use.

When the tape heads become dirty

- the sound is distorted
- there is a decrease in sound level
- the sound drops out
- the tape does not erase completely
- the tape does not record

Make sure to clean the tape heads before you start an important recording or after playing an old tape. Use separately sold dry-type or wet-type cleaning cassette. For details, refer to the instructions of the cleaning cassette.

### Demagnetizing the tape heads

Demagnetize the tape heads and the metal parts that have contact with the tape every 20 to 30 hours of use with a separately sold demagnetizing cassette. For details, refer to the instructions of the demagnetizing cassette.



---

# Troubleshooting

If you run into any problem using this stereo system, use the following checklist.

First, check that the power cord is connected firmly and the speakers are connected correctly and firmly.

Should any problem persist, consult your nearest Sony dealer.

---

## General

---

**The display starts flashing as soon as you plug in the power cord even though you haven't turned on the system (demonstration mode).**

- Press DISPLAY/DEMO while the system is off.

The demonstration appears automatically the first time you plug in the power cord, or if there is a power outage lasting longer than half a day.

In this case, reset the following:

- Clock setting (see "Step 2: Setting the time")
- Press DISPLAY/DEMO while the system is off.

---

**There is no sound.**

- Turn VOLUME clockwise.
- The headphones are connected.
- Insert only the stripped portion of the speaker cord into the SPEAKER jack. Inserting the vinyl portion of the speaker cord will interfere with the speaker connection.

---

**There is no microphone sound**

- Turn VOLUME or MIC LEVEL to adjust the microphone volume.
- Make sure the microphone is connected to the MIC jack correctly.

---

**There is severe hum or noise.**

- A TV or VCR is placed too close to the stereo system. Move the stereo system away from the TV or VCR.

---

**"0:00" (for European and Brazilian models) or "12:00AM" (for other models) flashes in the display.**

- A power interruption occurred. Reset the clock and timer settings.

---

**The timer does not function.**

- Set the clock correctly.

---

**DAILY 1, DAILY 2, and REC do not appear when you press ☺/CLOCK SET.**

- Set the timer correctly.
- Set the clock.

---

**The remote does not function.**

- There is an obstacle between the remote and the unit.
- The remote is not pointing in the direction of the system's sensor.
- The batteries have run down. Replace the batteries.

---

**There is acoustic feedback.**

- Decrease the volume level.
- Move the microphone away from the speakers or change the direction of the microphone.

---

**The color irregularity on a TV screen persists.**

- Turn off the TV set once, then turn it on after 15 to 30 minutes. If the color irregularity still persists, place the speakers farther away from the TV set.

---

**The sound from the connected source is distorted.**

- If "VIDEO" appears in the display when you press FUNCTION, switch the display to "MD" (see the note in the "Connecting an MD deck for analog recording" section on page 9).

---

## Speakers

---

**Sound comes from only one channel or the left and right volumes are unbalanced.**

- Check the speaker connections and placement.

---

**There is no sound from the surround speakers (LBT-D790/XB33/XB33K/XB50/XB60 only).**

- Press SURROUND to turn on the surround effect.
-

## CD Player

---

### The CD tray does not rotate.

- A CD is not placed properly.

### A CD will not play.

- The CD is not lying flat in the disc tray.
- The CD is dirty.
- The CD is inserted label side down.
- Moisture condensation has built up. Remove the CD and leave the system turned on for about an hour until the moisture evaporates.

### Play does not start from the first track.

- The player is in Program or Shuffle Play mode. Press PLAY MODE repeatedly until "PROGRAM" or "SHUFFLE" disappear from the display.

## Tape Deck

---

### The tape does not record.

- No tape is in the cassette holder.
- The tab has been removed from the cassette (see page 40).
- The tape has reeled to the end.

### The tape does not record nor play, or there is a decrease in sound level.

- The heads are dirty. Clean them (see page 40).
- The record/playback heads are magnetized. Demagnetize them (see page 40).

### The tape does not erase completely.

- The record/playback heads are magnetized. Demagnetize them (see page 40).

### There is excessive wow or flutter, or the sound drops out.

- The capstans or pinch rollers are dirty. Clean them (see page 40).

### Noise increases or the high frequencies are missing.

- The record/playback heads are magnetized. Demagnetize them (see page 40).

## Tuner

---

### Severe hum or noise ("TUNED" or "STEREO" flashes in the display).

- Adjust the antenna.
- The signal strength is too weak. Connect an external antenna.

### A stereo FM program cannot be received in stereo.

- Press STEREO/MONO so "STEREO" appears in the display.

### If other problems not described above occur, reset the system as follows:

#### (LBT-D390/D790/G5500/XB33/XB33K/XB44/XB44K/XB50/XB60 only)

- 1 Unplug the power cord.
- 2 Plug the power cord back in.
- 3 Press GROOVE, ENTER/NEXT, and DISC 1 at the same time.

#### (LBT-XB66/XB66K/XB660 only)

- 1 Unplug the power cord.
- 2 Plug the power cord back in.
- 3 Press SPECTRUM ANALYZER, ENTER, and DISC 1 at the same time.

# Specifications

## Amplifier section

(LBT-D390/D790/G5500)

Continuous RMS power output  
120 + 120 watts  
(8 ohms at 1 kHz, 10% THD)

Total harmonics distortion  
Less than 0.07%  
(8 ohms at 1 kHz, 50 W)

(LBT-XB50)

DIN power output (Rated)  
80 + 80 watts  
(8 ohms at 1 kHz, DIN)

Continuous RMS power output (Reference)  
100 + 100 watts  
(8 ohms at 1 kHz, 10% THD)

Music power output (Reference)  
170 + 170 watts  
(8 ohms at 1 kHz, 10% THD)

(LBT-XB60)

DIN power output (Rated)  
100 + 100 watts  
(8 ohms at 1 kHz, DIN)

Continuous RMS power output (Reference)  
120 + 120 watts  
(8 ohms at 1 kHz, 10% THD)

Music power output (Reference)  
210 + 210 watts  
(8 ohms at 1 kHz, 10% THD)

(LBT-XB33/XB33K)

The following measured at AC 120/240 V, 50 Hz

DIN power output (Rated)  
100 + 100 watts  
(6 ohms at 1 kHz, DIN)

Continuous RMS power output (Reference)  
120 + 120 watts  
(6 ohms at 1 kHz, 10% THD)

Peak music power output (Reference)  
1,500 watts

(LBT-XB44/XB44K)

The following measured at AC 120/240 V, 50 Hz  
DIN power output (Rated)

120 + 120 watts  
(6 ohms at 1 kHz, DIN)

Continuous RMS power output (Reference)  
140 + 140 watts  
(6 ohms at 1 kHz, 10% THD)

Peak music power output (Reference)  
2,000 watts

(LBT-XB66/XB66K/XB660)

The following measured at AC 120/240 V, 50 Hz  
DIN power output (Rated)

140 + 140 watts  
(8 ohms at 1 kHz, DIN)

Continuous RMS power output (Reference)  
170 + 170 watts  
(8 ohms at 1 kHz, 10% THD)

Peak music power output (Reference)  
3,000 watts

Inputs

PHONO IN (phono jacks):  
sensitivity 3 mV,  
impedance 47 kilohms

MIX MIC (phone jack):  
sensitivity 1 mV,  
impedance 10 kilohms

(LBT-D390/D790/G5500)

VIDEO (AUDIO) IN (phono jacks):  
sensitivity 250 mV,  
impedance 47 kilohms

(LBT-XB33/XB33K/XB44/XB44K/XB50/XB60/  
XB66/XB66K/XB660)

VIDEO/MD (AUDIO) IN (phono jacks):  
sensitivity 250 mV,  
impedance 47 kilohms

Outputs

PHONES (stereo phone jack):  
accepts headphones of 8  
ohms or more

(LBT-XB33/XB33K/XB44/XB44K/XB50/XB60/  
XB66/XB66K/XB660)

VIDEO/MD (AUDIO) OUT (phono jacks):  
voltage 250 mV,  
impedance 1 kilohm

SPEAKER:

(LBT-D390/D790/G5500/XB50/XB60/XB66/  
XB66K/XB660)  
accepts impedance of 8 to  
16 ohms.

(LBT-XB33/XB33K/XB44/XB44K) accepts  
impedance of 6 to 16  
ohms.

SURROUND SPEAKER

(LBT-D790/XB33/XB33K/XB50/XB60 only)  
accepts impedance of 16  
ohms

## CD player section

System	Compact disc and digital audio system
Laser	Semiconductor laser ( $\lambda = 780 \text{ nm}$ ) Emission duration: continuous Max. $44.6 \mu\text{W}^*$ * This output is the value measured at a distance of 200 mm from the objective lens surface on the Optical Pick-up Block with 7 mm aperture.
Laser output	780 – 790 nm
Wavelength	2 Hz – 20 kHz ( $\pm 0.5 \text{ dB}$ )
Frequency response	More than 90 dB
Signal-to-noise ratio	More than 90 dB
Dynamic range	(LBT-XB33/XB33K/XB44/XB44K/XB50/XB60/XB66/XB66K/XB660)
CD DIGITAL OUT	(square optical connector jack, rear panel)
Wave length:	600 nm
Output level:	-18 dBm

## Tape player section

Recording system	4-track 2-channel stereo
Frequency response (DOLBY NR OFF)	60 – 13,000 Hz ( $\pm 3 \text{ dB}$ ), using a Sony TYPE I cassette
	60 – 14,000 Hz ( $\pm 3 \text{ dB}$ ), using a Sony TYPE II cassette
Wow and flutter	$\pm 0.15\%$ W. Peak (IEC) 0.1% W. RMS (NAB) $\pm 0.2\%$ W. Peak (DIN)

## Tuner section

FM stereo, FM/AM superheterodyne tuner

### FM tuner section

Tuning range (2 band model)	
North American model:	87.5 – 108.0 MHz (100 kHz step)
Other models:	87.5 – 108.0 MHz (50 kHz step)
(3 band model)	87.5 – 108.0 MHz (50 kHz step)
(4 band model)	
FM:	87.5 – 108.0 MHz (50 kHz step) 65.0 – 74.0 MHz (10 kHz step) OIRT
UKV:	65.0 – 74.0 MHz (10 kHz step) POLAR STEREO
Antenna	FM wire antenna
Antenna terminals	75 ohm unbalanced
Intermediate frequency	10.7 MHz

## AM tuner section

Tuning range (2 band model)	
North American model:	530 – 1,710 kHz (with the tuning interval set at 10 kHz) 531 – 1,710 kHz (with the tuning interval set at 9 kHz)
Other models:	531 – 1,602 kHz (with the tuning interval set at 9 kHz) 530 – 1,710 kHz (with the tuning interval set at 10 kHz)
(3 band and 4 band models)	
MW:	531 – 1,602 kHz (with the tuning interval set at 9 kHz)
LW:	153 – 279 kHz (with the tuning interval set at 3 kHz)
Antenna	AM loop antenna, External antenna terminals
Intermediate frequency	450 kHz

## Speakers

### SS-D3900/G5500/XB33/XB33V/XB50 for LBT-D390/G5500/XB33/XB33K/XB50

Speaker system (SS-D3900/G5500/XB33/XB50)	3-way, 3-unit, bass-reflex type
(SS-XB33V)	3-way, 3-unit, bass-reflex, Magnetically shielded type
Speaker units	
Woofers:	17 cm dia., cone type
Tweeters:	6 cm dia., cone type
Super Tweeter:	2 cm dia., dome type
Rated impedance:	
(SS-D3900/G5500/XB50)	8 ohms
(SS-XB33/XB33V)	6 ohms
Dimensions (w/h/d)	Approx. $245 \times 480 \times 320 \text{ mm}$ ( $9 \frac{3}{4} \times 19 \times 12 \frac{5}{8} \text{ in}$ )
Mass	
(SS-D3900/G5500/XB33/XB50)	Approx. 6.5 kg (14 lb 5 oz.) net per speaker
(SS-XB33V)	Approx. 6.7 kg (14 lb 12 oz.) net per speaker

**SS-D7900/XB44/XB44V/XB60/XB660 for LBT-D790/XB44/XB44K/XB60/XB660**

Speaker system	3-way, 3-unit, SAW Magnetically shielded type (SS-XB44V only)
Speaker units	
Super Woofer:	17 cm dia., cone type
Woofer:	17 cm dia., cone type
Tweeter:	6 cm dia., cone type
Rated impedance:	
(SS-D7900/XB60/XB660)	

(SS-XB44/XB44V)	8 ohms
(SS-XB44/XB44V)	6 ohms
Dimensions (w/h/d)	Approx. 260 × 525 × 395 mm (10 <sup>1</sup> / <sub>4</sub> × 20 <sup>3</sup> / <sub>4</sub> × 15 <sup>5</sup> / <sub>8</sub> in)

Mass	Approx. 10.0 kg (22 lb 1 oz.) net per speaker
------	---

**SS-XB66V for LBT-XB66/XB66K**

Speaker system	4-way, 4-unit, SAW, Magnetically shielded type
----------------	---

Speaker units	
Super Woofer:	17 cm dia., cone type
Woofer:	20 cm dia., cone type
Tweeter:	6 cm dia., cone type
Super Tweeter:	2 cm dia., dome type
Rated impedance:	
(SS-XB66V)	8 ohms
Dimensions (w/h/d)	Approx. 285 × 590 × 425 mm (11 <sup>1</sup> / <sub>4</sub> × 23 <sup>1</sup> / <sub>4</sub> × 16 <sup>3</sup> / <sub>4</sub> in)

Mass	Approx. 15.0 kg (33 lb 1 oz.) net per speaker
------	---

**General**

## Power requirements

North American model:	120 V AC, 60 Hz
European model:	230 V AC, 50/60 Hz
Mexican model:	120 V AC, 50/60 Hz
Australian and South African models:	220 – 240 V AC, 50/60 Hz
Thailand model:	220 – 240 V AC, 50/60 Hz
Other models:	110 – 120 V or 220 – 240 V AC, 50/60 Hz Adjustable with voltage selector

## Power consumption

(LBT-D390/G5500)	170 watts
(LBT-D790)	198 watts
(LBT-XB50)	190 watts
(LBT-XB60)	230 watts
(LBT-XB33/XB33K)	240 watts
(LBT-XB44/XB44K)	250 watts
(LBT-XB66/XB66K/XB660)	320 watts

Dimensions (w/h/d)	Approx. 355 × 425 × 435 mm (14 × 16 <sup>3</sup> / <sub>4</sub> × 17 <sup>1</sup> / <sub>4</sub> in) incl. projecting parts and controls
--------------------	---

Mass	
(LBT-D390/G5500)	Approx. 12.5 kg (27 lb 9 oz.)
(LBT-D790/XB50/XB60)	Approx. 13.0 kg (28 lb 11 oz.)
(LBT-XB33/XB33K/XB44)	Approx. 14.0 kg (30 lb 14 oz.)
(LBT-XB44K/XB66/XB660)	Approx. 14.5 kg (31 lb 16 oz.)
(LBT-XB66K)	Approx. 15.5 kg (34 lb 2 oz.)

Supplied accessories	AM loop antenna (1) Remote RM-SD70S (1) Size AA (R6) batteries (2) FM wire antenna (1) Speaker cords* (2)
----------------------	---

\* except for LBT-D390/G5500/XB33/XB33K/XB50

**Optional accessory (for LBT-D790)****Surround speaker SS-SR120**

Speaker system	Full range, bass-reflex type
Speaker unit	10 cm dia., cone type
Nominal impedance	16 ohms
Dimensions (w/h/d)	Approx. 175 × 127 × 185 mm (7 × 5 × 7 <sup>3</sup> / <sub>8</sub> in)
Mass	Approx. 1.3 kg (2 lb 14 oz.) net per speaker

Design and specifications are subject to change without notice.

# Index

## A

- Adjusting
  - the audio emphasis 30
  - the sound 28
  - the volume 12, 14, 17
- Antennas 5, 10
- Audio emphasis 29, 30
- Automatic Source Selection 12, 14, 17

## B

- Batteries 5

## C

- CD player 11, 19
- CD Synchro Recording 13
- Clock setting 6
- Connecting. *See* Hooking up

## D, E

- Display 5, 19, 29
- Dubbing 18

## F, G

- Flash 26

## H, I, J

- Hooking up
  - optional components 8
  - optional speakers 9
  - the antennas 5, 10
  - the power 5
  - the system 4

## K

- Karaoke 34
  - to reduce the vocals (KARAOKE PON) 34
  - to sing along with a multiplex CD or tape (MPX R/MPX L) 34
  - to adjust the key (LBT-XB33K/XB44K/XB66K only) 35
  - to adjust the microphone echo (LBT-XB33K/XB44K/XB66K only) 35

## L

- Loop 26

## M

- Microphone
  - mixing 35
- Mixing sound 35

## N

- Normal Play 11
- Non-Stop Play 22

## O

- One Touch Play 12, 14, 17

## P, Q

- Personal File 31
- Playing
  - a CD 11
  - a preset radio station 14
  - a tape 16
  - tracks in random order (Shuffle Play) 20
  - tracks in the desired order (Program Play) 21
  - tracks repeatedly (Repeat Play) 19
  - without interruption 22
- Presetting radio stations 7
- Preset tuning 14
- Program Edit 24
- Program Play 21
- Protecting recordings 40
- PTY\* 32

## R

- Radio stations
  - presetting 7
  - tuning in 14
- RDS\* 32
- Recording
  - a CD 13
  - a radio program 15
  - a tape manually 23
  - another tape 18
  - CDs by specifying the track order 24
  - selecting tape length automatically 25
  - timer recording 38
- Repeat Play 19
- Resetting the system 42

## S

- Saving recordings 40
- Setting the time 6
- Shuffle Play 20
- Sleep Timer 36
- Sound adjustment 28
- Speakers 4, 9
- Surround effect 30

## T, U, V

- Tape Select Edit 25
- Timer
  - falling asleep to music 36
  - timer recording 38
  - waking up to music 37
- Troubleshooting 41
- Tuner 7, 14, 15
- Tuning interval 7
- Turntable 8

## W, X, Y, Z

- Wake-up timer 37
- Wave 27

\* For European model only



