

FM/AM Cassette Car Stereo

Operating Instructions _____

EN

Owner's Record

The model and serial numbers are located on the bottom of the unit.

Record the serial number in the space provided below.

Refer to these numbers whenever you call upon your Sony dealer regarding this product.

Model No. XR-C6100 Serial No. _____

For installation and connections, see the supplied Installation/Connections manual.

XR-C6100

Warning

This equipment has been tested and found to comply with the limits for a Class B digital device, pursuant to Part 15 of the FCC Rules. These limits are designed to provide reasonable protection against harmful interference in a residential installation. This equipment generates, uses, and can radiate radio frequency energy and, if not installed and used in accordance with the instructions, may cause harmful interference to radio communications. However, there is no guarantee that interference will not occur in a particular installation. If this equipment does cause harmful interference to radio or television reception, which can be determined by turning the equipment off and on, the user is encouraged to try to correct the interference by one or more of the following measures:

- Reorient or relocate the receiving antenna.
- Increase the separation between the equipment and receiver.
- Connect the equipment into an outlet on a circuit different from that to which the receiver is connected.
- Consult the dealer or an experienced radio/TV technician for help.

You are cautioned that any changes or modifications not expressly approved in this manual could void your authority to operate this equipment.

Welcome!

Thank you for purchasing the Sony Cassette Car Stereo. This unit lets you enjoy a variety of features by using an optional rotary commander and wireless remote commander.

In addition to the tape playback and the radio operation you can expand your system by connecting optional CD/MD unit*.

* *You can connect to an CD changer, MD changer, or an CD player, MD player.*

Table of contents

This Unit Only

Getting Started

Resetting the unit	4
Detaching the front panel	4
Setting the clock	5

Cassette Player

Listening to a tape	5
Playing a tape in various modes	6

Radio

Memorizing stations automatically	
— Best Tuning Memory (BTM)	7
Memorizing only the desired stations	7
Receiving the memorized stations	7
Storing the station names	
— Station Memo	8

Other Functions

Adjusting the sound characteristics	9
Attenuating the sound	9
Changing the sound and beep tone	9

With Optional Equipment

CD/MD Unit

Playing a CD/MD	10
Scanning the tracks	
— Intro scan	11
Playing tracks repeatedly	
— Repeat play	11
Playing tracks in random order	
— Shuffle play	11
Labeling a CD	
— Disc Memo (CD unit with custom file function)	12
Selecting the specific tracks for playback	
— Bank (CD unit with custom file function) 12	

EN

Additional Information

Precautions	13
Maintenance	14
Dismounting the unit	15
The rotary commander labels	15
Location of controls	16
Specifications	18
Troubleshooting guide	19
Index	21

Getting Started

Resetting the unit

Before operating the unit for the first time or after replacing the car battery, you must reset the unit.

Press the reset button with a pointed object, such as a ball-point pen.

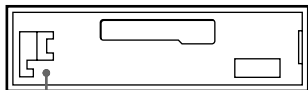

Reset button

Note

Pressing the reset button will erase all the memorized programme and memory functions.

EN

Detaching the front panel

The front panel of this unit can be detached to prevent the unit from being stolen.

- 1 Press **OFF**.
- 2 Press **RELEASE** to open up the front panel. Then slide the front panel a little to the left, and pull it off towards you.

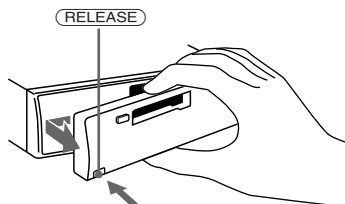

Notes

- Be sure not to drop the panel when detaching it from the unit.
- If you press **RELEASE** to detach the panel while the unit is still turned on, the power will automatically turn off to protect the speakers from being damaged.

Attaching the front panel

Attach part **A** of the front panel to part **B** of the unit as illustrated and push until it clicks.

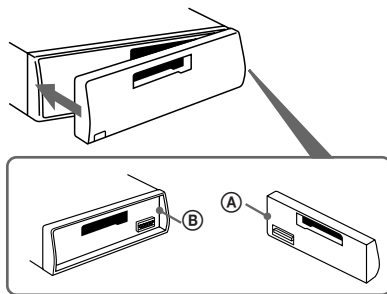

Notes

- Make sure the front panel is right side up when attaching it to the unit as it cannot be attached upside down.
- Do not press the front panel too hard when attaching it to the unit. It can easily be attached by pressing it lightly against the unit.
- When you carry the front panel with you, keep it in the supplied case.
- Do not press hard or put excessive pressure on the display windows of the front panel.
- Do not expose the front panel to direct sunlight, heat sources such as hot air ducts or leave it in a humid place. Never leave it on the dashboard etc. of a car parked in direct sunlight where there may be a considerable rise in temperature inside the car.

Caution alarm

If you turn the ignition key to the OFF position without removing the front panel, the caution alarm will beep for a few seconds (only when the POWER SELECT switch is set to the **A** position).

If you connect an optional power amplifier to the LINE OUT and do not use the built-in amplifier, the beep tone will be disabled.

Setting the clock

The clock has a 12-hour digital indication.
For example, setting it to 10:08

- 1 Press **(OFF)** or **(DSPL)** during operation.
- 2 Press **(DSPL)** for two seconds.



The hour digit blinks.

- 1 Set the hour digits.



to go forward

to go backward



- 2 Press **(SEL)** momentarily.



The minute digit blinks.

- 3 Set the minute digits.



to go forward

to go backward

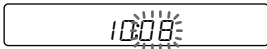

- 3 Press **(DSPL)** momentarily.

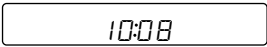

The clock activates.

Note

If the **POWER SELECT** switch on the bottom of the unit is set to the **(B)** position, the clock cannot be set unless the power is turned on. Set the clock after you have turned on the radio.

Cassette Player

Listening to a tape

Insert a cassette.

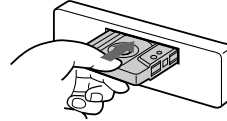

Playback will start automatically.

If a cassette is already inserted, press **(SOURCE)** repeatedly until "PLAY" is displayed.

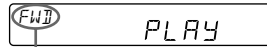

The side facing up is being played.

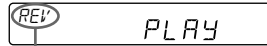

The side facing down is being played.

Tip

To change the tape transport direction, press **(MODE)** (**<▶>**) during tape playback.

To	Press
Stop playback	(OFF)
Eject the cassette	▲

Fast-winding the tape

During playback, press either side of **(SEEK/AMS)** more than two second.



Fast-forward

Rewind

To start playback during fast-forwarding or rewinding, press **(MODE)** (**<▶>**).

Locating the beginning of a track

— Automatic Music Sensor (AMS)

You can skip up to nine tracks at one time.

During playback, press either side of **(SEEK/AMS)** momentarily.



To locate the succeeding tracks

To locate the preceding tracks

Note

The AMS function may not work when :

- the blanks between tracks are shorter than 4 seconds
- there is noise between tracks
- there are long sections of low volume or quiet sections.

Changing the displayed items

Each time you press **(DSPL)** momentarily during tape playback, the displayed item changes as follows:



* While the ATA function activated.

EN

Playing a tape in various modes

Searching for the desired track

— Intro scan

Press **(1)** during playback.

“INTRO” appears on the display.

The first 10 seconds of all the tracks are played.

When you find the desired track, press again. The unit returns to the normal playback mode.

Playing tracks repeatedly

— Repeat play

Press **(2)** during playback.

“REP” appears on the display.

When the currently played track is over, it will be played again from the beginning.

To cancel this function, press **(2)** again.

Switching to the radio while fast-winding a tape

— Automatic Tuner Activation (ATA)

Press **(5)** during playback.

“ATA” appears on the display.

When fast-forwarding or rewinding with **(SEEK/AMS)** for two seconds, the tuner will turn on automatically.

To cancel this function, press **(5)** again.

Skipping blanks during tape playback — Blank skip

Press **(6)** during playback.

“BL SKIP” appears on the display.

Blanks longer than eight seconds will automatically be skipped during tape playback.

To cancel this function, press **(6)** again.

Playing a tape recorded in the Dolby B NR system

Press the **(3)** when you want to listen to a tape recorded in the Dolby* B NR system.

“□□” appears on the display.

To cancel this function, press **(3)** again.

* Dolby noise reduction manufactured under license from Dolby Laboratories Licensing Corporation. “DOLBY” and the double-D symbol □□ are trademarks of Dolby Laboratories Licensing Corporation.

Playing a CrO₂ or metal tape

Press **(4)** when you want to listen to a CrO₂ (TYPE II) or metal (TYPE IV) tape.

“MTL” appears on the display.

To cancel this function, press **(4)** again.

Memorizing stations automatically

— Best Tuning Memory (BTM)

This function selects from the currently received band the stations with the strongest signals and memorizes them in order of their frequency.

PREVENTING ACCIDENTS!

When tuning in while driving, use the automatic tuning or memory preset search function instead of manual tuning.

- 1 Press **(SOURCE)** repeatedly to select the tuner.
Each time you press **(SOURCE)**, the source changes as follows:

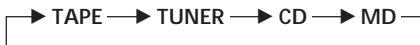

- 2 Press **(MODE)** repeatedly to select the band.
Each time you press **(MODE)**, the band changes as follows:



- 3 Press **(LCL/BTM)** for two seconds.

Notes

- The unit will not store stations with weak signals on the preset number buttons. If there are only a few stations received, some preset number buttons will remain empty.
- When a preset number indicated on the display, the unit starts storing station from the one currently display.

Memorizing only the desired stations

Up to 6 stations on each band (FM1, FM2, FM3, AM1, and AM2) can be stored on the preset number buttons in the order of your choice. Therefore, 18 FM stations can be memorized. If you try to store another station on the same preset number button, the most recent stored station will be erased.

- 1 Press **(SOURCE)** repeatedly to select the tuner.
- 2 Press **(MODE)** repeatedly to select the band.
- 3 Press **(SEEK/AMS)** to search for the station you wish to store on a preset number button.
- 4 Press the desired preset number button (① to ⑥) for two seconds.

The number of the selected preset number button appears on the display.

Receiving the memorized stations

- 1 Press **(SOURCE)** repeatedly to select the tuner.
- 2 Press **(MODE)** repeatedly to select the band.
- 3 Press the preset number button momentarily (① to ⑥) on which the desired station is stored.

Tip

Press either side of **(PRESET/DISC)** to receive in order the stations stored in the memory (Preset Search Function).

Changing the displayed items

Each time you press **(DSPL)**, the display changes between the frequency and the clock.

If you cannot tune in a preset station

Press either side of **(SEEK/AMS)** momentarily to search for the station (automatic tuning).
Scanning stops when a station is received.
Press either side of **(SEEK/AMS)** repeatedly until the desired station is received.

Note

If the automatic tuning stops too frequently, press **(LCU/BTM)** momentarily until "LCL" light up on the display (local seek mode). Only the stations with relatively strong signals are tuned in.

Tip

If you know the frequency, press and hold either side of **(SEEK/AMS)** until the desired station is received (manual tuning).

3 Enter the characters.

1 Press **(+)** to select the desired characters.

(A → B → C → ... Z → 0 → 1 → 2 → ... 9 → + → - → * → / → \ → > → < → . → _)

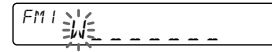

If you press **(-)**, the characters appear in the reverse order.

If you want to put a blank space between characters, select "_" (under-bar).

2 Press **(SEL)** after locating the desired character.

The flashing cursor moves to the next space.

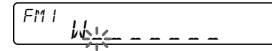

If you press **(SEL)** when the eighth character (farthest right character) is flashing, the flashing part goes back to the first character (farthest left character).

3 Repeat steps 1 and 2 to enter the entire name.

4 To return to the normal radio reception, press **(FILE)** for two seconds.

Tip

To erase/correct a name, enter "_" (under-bar) for each character.

Displaying the station name

Press **(DSPL)** during radio reception.

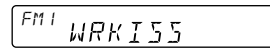

Each time you press **(DSPL)**, the item changes as follows:



* If the station name is not stored, "NO NAME" appears in the display for one second.

Storing the station names

— Station Memo

You can assign a name to each radio station and store it in memory. The name of the station currently tuned in appears in the display. You can store up to eight characters for a station.

Storing the station names

1 Tune in a station whose name you want to store.

2 Press **(FILE)** for two seconds.

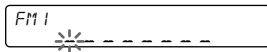

Erasing the station name

- 1 Tune in any station and press **(FILE)** for two seconds.
- 2 Press **(5)** while pressing **(SEL)**.
- 3 Press **(+)** or **(-)** to select the name that you want to erase.
- 4 Press **(SEL)** for two seconds.
The name is erased.
Repeat steps 3 and 4 if you want to erase other names.
- 5 Press **(FILE)** for two seconds.
The unit returns to the normal radio reception mode.

Other Functions

Adjusting the sound characteristics

- 1 Select the item you want to adjust by pressing **(SEL)** repeatedly.
VOL (volume) → BAS (bass) → TRE (treble)
→ BAL (left-right) → FAD (front-rear)
- 2 Adjust the selected item by pressing either **(+)** or **(-)**.

Adjust within three seconds after selecting.
(After three seconds the button will again serve as the volume control button.)

Attenuating the sound

Press **(ATT)**.
The "ATT" indication flashes.

To restore the previous volume level, press again.

Changing the sound and beep tone

Boosting the bass sound — D-bass

You can enjoy clear and powerful bass sound. The D-bass function boosts the low frequency signal with a sharper curve than conventional bass boost.

You can hear the bass line more clearly even if the vocal volume remains the same. You can emphasize and adjust the bass sound easily with the D-bass control. This effect is similar to the one you get when you use an optional subwoofer system.

Moreover, the Digital D-bass* function creates even sharper and more powerful bass sounds than Analog D-bass.

continue to next page →

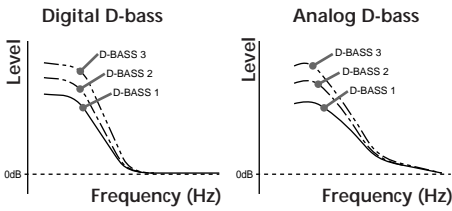

Adjusting the bass curve

Turn the D-BASS control to adjust the bass level (1, 2 or 3).
 “D-BASS”* appears in the display.

To cancel, turn the control to the OFF position.

* If an optional CD changer has the Digital D-bass function, “DIGITAL D-BASS” appears on the display during CD playback.

Note
 If the bass sound becomes distorted, adjust the D-BASS control or volume button.

Attenuating the beep tone

Press **(6)** while pressing **(SEL)**.
 To obtain the beep tone again, press these buttons again.

Note
 If you connect an optional power amplifier to the LINE OUT and do not use the builtin amplifier, the beep tone will be disabled.

With Optional Equipment CD/MD Unit

This unit can control a maximum of seven external CD/MD units in this configuration:
 CD unit - maximum of five
 MD unit - maximum of five.
 Any combination up to seven will work.

Playing a CD/MD

Press **(SOURCE)** until the desired unit indication appears on the display.
 CD/MD playback starts.

When a CD/MD unit is connected, all the tracks play from the beginning.

Selecting CD/MD units (when several CD/MD units are connected)

Press **(MODE)** repeatedly to select the desired CD/MD unit.

Changing the displayed items

Each time you press **(DSPL)** during CD/MD playback, the item changes as follows:

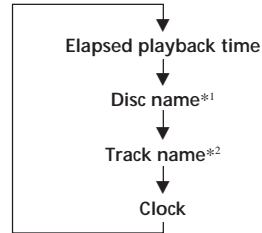

*1 If there is no prerecorded name for a CD or MD, “NO NAME” appears in the display.

*2 If the track name of an MD is not prerecorded “NO NAME” appears in the display.

Tip
 If the name of the MD is too long, only the first eight characters appear in the display.

Locating a specific track — Automatic Music Sensor (AMS)

During playback, press either side of **(SEEK/AMS)** once for each track you wish to skip the tracks.



To locate the succeeding tracks

To locate the preceding tracks

Locating a specific point in a track

— Manual Search

During playback, press and hold either side of (SEEK/AMS). Release the button when you have found the desired part.



To search forward

To search backward

Switching to other discs

During playback, press either side of (PRESET/DISC).

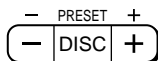

To return to the previous disc

To advance to the next disc

Scanning the tracks

— Intro scan

The first 10 seconds of all the tracks on the current disc are played in order. After the first disc is over, the next disc is played.

Press (1) during playback. "INTRO" appears on the display.

When you find the desired track, press again. The unit returns to the normal CD/MD playback mode.

Playing tracks repeatedly

— Repeat play

To repeat a track

Press (2) repeatedly during CD/MD playback until "REP 1" is displayed.

To repeat a disc

Press (2) repeatedly during CD/MD playback until "REP 2" is displayed.

To repeat all the discs in the current unit

Press (2) repeatedly during CD/MD playback until "REP 3" is displayed.

Each time you press (2) the display changes as follows:

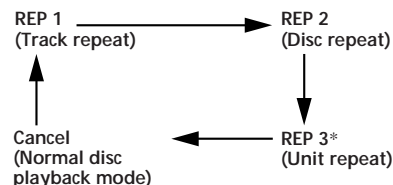

* "REP 3" only when two or more CD/MD units are connected the unit.

Playing tracks in random order — Shuffle play

To play the tracks on the current disc in random order

Press (3) repeatedly during CD/MD playback until "SHUF 1" is displayed.

To play all the discs in the unit in random order

Press (3) repeatedly during CD/MD playback until "SHUF 2" is displayed.

To play all the discs in the current connected CD/MD units in random order

Press (3) repeatedly during CD/MD playback until "SHUF 3" is displayed.

Each time you press (3) the display changes as follows:

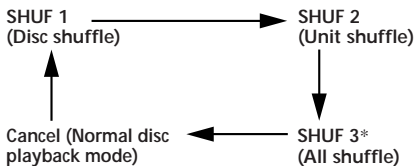

* "SHUF 3" only when two or more CD/MD units are connected the unit.

Note
CD/MD units are operated separately.

If you press (1) during shuffle play, the first 10 seconds of all tracks will be played in random order.

Labeling a CD

— Disc Memo
(CD unit with custom file function)

You can label each disc with a personalized name. You can enter up to 8 characters for a disc. If you label a CD, you can locate a disc by name and select the specific tracks for playback.

- 1 Play the CD and press **(FILE)** for two seconds.

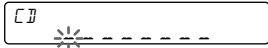

- 2 Enter the characters.

- 1 Press **(+)** to select the desired characters.
(A → B → C → ... Z → 0 → 1 → 2 → ... 9 → + → - → * → / → \ → > → < → . → _)

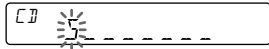

If you press **(-)**, the characters appear in the reverse order.

If you want to put a blank space between characters, select “_” (under-bar).

- 2 Press **(SEL)** after locating the desired character.
The flashing cursor moves to the next space.



If you press **(SEL)** when the eighth character (farthest right character) is flashing, the flashing part goes back to the first character (farthest left character).

- 3 Repeat steps 1 and 2 to enter the entire name.

- 3 To return to the normal CD playback mode, press **(FILE)** for two seconds.

Tip

To erase/correct a name, enter “_” (under-bar) for each character.

Note

If you try to label an MD and you have not connected a CD changer with the custom file function, “*FULL*” then “- - - - -” appear in the display, but you cannot input characters. In this case, press **(FILE)** for two seconds.

Displaying the disc memo

Press **(DSPL)** during CD playback.



Each time you press **(DSPL)** during CD playback, the item changes as follows:

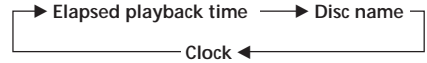

Erasing the disc memo

- 1 Press **(SOURCE)** to select the CD unit.
- 2 Play the CD and press **(FILE)** for two seconds.
- 3 Press **(5)** while pressing **(SEL)**.
- 4 Press **(+)** or **(-)** to select the name that you want to erase.
- 5 Press **(SEL)** for two seconds.
The name is erased.
Repeat steps 4 and 5 if you want to erase other names.
- 6 Press **(FILE)** for two seconds.
The unit returns to the normal CD playback mode.

Selecting the specific tracks for playback

— Bank
(CD unit with custom file function)

If you label the disc, you can set the unit to skip tracks and play only the tracks you want.

- 1 Start playing the disc and press **(FILE)** for two seconds. Then press **(FILE)** momentarily.
Bank edit mode

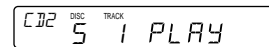

Note

If you have not labeled the disc, you cannot use this function. For more information on “Labelling a CD”, refer to this page.

Additional Information

Precautions

- If your car was parked in direct sunlight resulting in a considerable rise in temperature inside the car, allow the unit to cool off before operating it.
- If no power is being supplied to the unit, check the connections first. If everything is in order, check the fuse.
- If no sound comes from the speakers of a 2-speaker system, set the fader control to the center position.
- When the tape is played back for a long period, the cassette may become warm because of the built-in power amplifier. However, this is not a sign of malfunction.

If you have any questions or problems concerning your unit that are not covered in this manual, please consult your nearest Sony dealer.

To maintain high quality sound

If you have drink holders near your audio equipment, be careful not to splash juice or other soft drinks onto the car audio. Sugary residues on this unit or cassette tapes may contaminate the playback heads, reduce the sound quality, or prevent sound reproduction altogether. Cassette cleaning kits cannot remove sugar from the tape heads.



- 2 Press either side of (SEEK/AMS) to select the track number you want to skip and press (SEL).

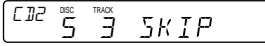

The indication changes from "PLAY" to "SKIP." If you want to return to "PLAY," press (SEL) again.

- 3 Repeat step 2 to set the "PLAY" to "SKIP" mode on all the tracks.
- 4 Press (FILE) for two seconds.

The unit returns to the normal CD playback mode.

Notes

- You can set the "SKIP" mode on up to 24 tracks.
- You cannot set the "SKIP" mode on all the tracks.

Playing the specific tracks only

You can select:

- BANK-ON to play the tracks with "PLAY" setting.
- BANK-INV (inverse) to play the tracks with the "SKIP" setting.

- 1 During playback, press (4). "BANK" appears on the display.
- 2 Press (4) to select the desired mode.

Each time you press (4), the display changes as follows:

→ BANK-ON → BANK-INV → BANK-OFF

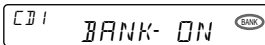

Playback starts from the track following the current one.

To go back to the normal playing mode, select "BANK-OFF" in step 2.

Notes on Cassettes

Cassette care

- Do not touch the tape surface of a cassette, as any dirt or dust will contaminate the heads.
- Keep cassettes away from equipment with built-in magnets such as speakers and amplifiers, as erasure or distortion on the recorded tape could occur.
- Do not expose cassettes to direct sunlight, extremely cold temperatures or moisture.
- Slack in the tape may cause the tape to be caught in the machine. Before you insert the tape, use a pencil or similar object to turn the reel and take up any slack.

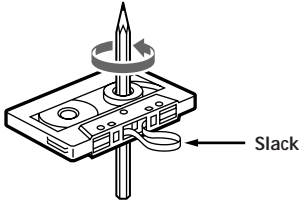

EN

- Distorted cassettes and loose labels can cause problems when inserting or ejecting tapes. Remove or replace loose labels.



Cassettes longer than 90 minutes

The use of cassettes longer than 90 minutes is not recommended except for long continuous play. The tapes used for these cassettes are very thin and tend to be stretched easily. Frequent playing and stopping of these tapes may cause them to be pulled into the cassette deck mechanism.

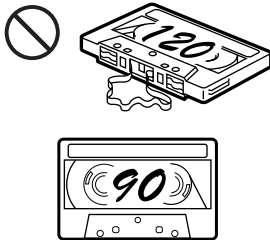

Maintenance

Fuse Replacement

When replacing the fuse, be sure to use one matching the amperage rating stated on the original fuse. If the fuse blows, check the power connection and replace the fuse. If the fuse blows again after replacement, there may be an internal malfunction. In such a case, consult your nearest Sony dealer.

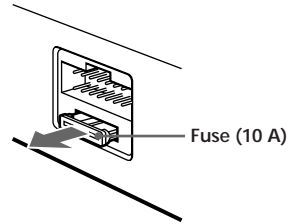

Warning

Never use a fuse with an amperage rating exceeding the one supplied with the unit as this could damage the unit.

Cleaning the Connectors

The unit may not function properly if the connectors between the unit and the front panel are not clean. In order to prevent this, open the front panel by pressing **RELEASE**, then detach it and clean the connectors with a cotton swab dipped in alcohol. Do not apply too much force. Otherwise, the connectors may be damaged.

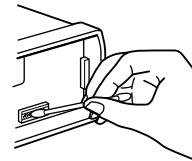

Main unit

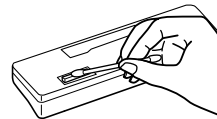

Back of the front panel

Dismounting the unit

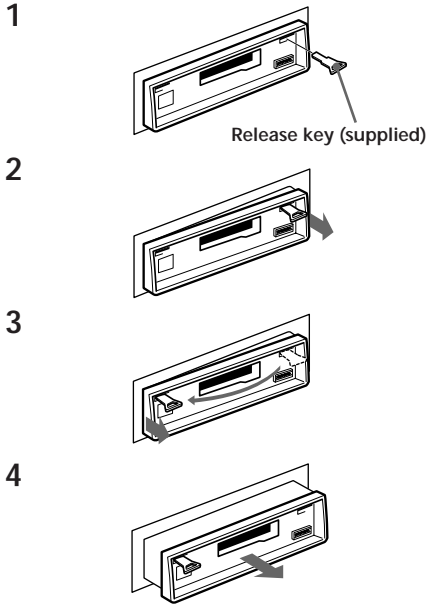

The rotary commander labels

You can control this unit with the optional rotary commander (RM-X4S). Some labels are supplied with the rotary commander. Attach that label which matches the functions of the master unit and the mounting position of the rotary commander. When you mount the rotary commander, attach the appropriate label, as in the illustration below.

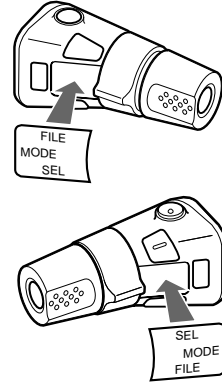

EN

Additional Information

Location of controls

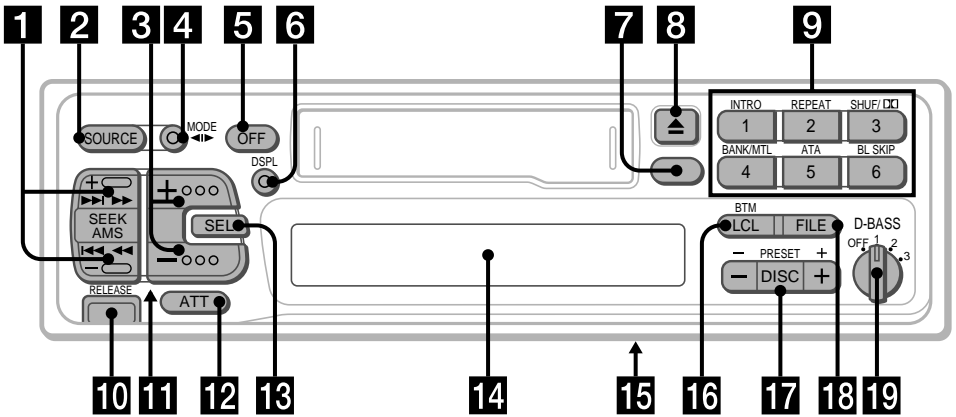

Refer to the pages for further details.

- 1** SEEK/AMS button 5, 6, 7, 8, 10, 11, 13
- 2** SOURCE button (TAPE/TUNER/CD/MD) 5, 7, 10, 12
- 3** (+) (-) (volume/bass/treble/left-right/ front-rear control) button 5, 8, 9, 12
- 4** MODE (◀▶) button
During Tuner reception:
BAND select 7

During Tape playback:
Transport direction change 5

During CD/MD playback:
Unit select 10
- 5** OFF button 4, 5
- 6** DSPL (display mode change/time set) button 5, 6, 8, 10, 12
- 7** Receptor for wireless remote
- 8** ▲ (eject) button 5
- 9** During radio reception:
Preset number buttons 7

During tape/CD/MD playback:
① INTRO button 6, 11
② REPEAT button 6, 11
③ SHUF/□ (Shuffle/Dolby B NR) button 6, 11
④ BANK/MTL button 6, 13
⑤ ATA (Automatic Tuner Activation) button 6
⑥ BL SKIP (Blank skip) button 6
- 10** RELEASE (front panel release) button 4, 14
- 11** Reset button (located on the front side of the unit hidden by the front panel) Press this button when you use this unit for the first time, when you have changed the car battery, or when the buttons of this unit do not function properly.
- 12** ATT button 9
- 13** SEL (control mode select) button 5, 8, 9, 10, 12, 13
- 14** Display window
- 15** POWER SELECT switch (located on the bottom of the unit) See "POWER SELECT Switch" in the Installation/Connections manual.
- 16** LCL/BTM (local seek adjust/Best tuning memory function) button 7, 8
- 17** PRESET/DISC button
During Tuner reception:
Preset stations select 7

During CD/MD playback:
Disc change 11
- 18** FILE (Custom file mode select•set) button 8, 9, 12, 13
- 19** D-BASS control 9, 10

**Optional Wireless
Remote Commander
(RM-X47)**

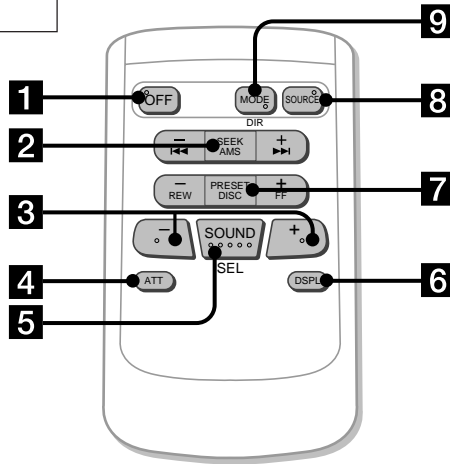

- 1** OFF button
- 2** SEEK/AMS button
You cannot do the manual search and manual tuning with the remote commander.
- 3** (+) (-) button
- 4** ATT button
- 5** SOUND/SEL button
- 6** DSPL button
- 7** PRESET/DISC button
- 8** SOURCE button
Press to select program sources.
Each time the button is pressed, the program source mode changes as follows:

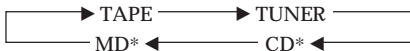

* When the CD/MD unit is connected.

- 9** MODE/DIR button
During Tape playback:
Changes the playback side of the cassette.
During CD/MD playback:
Selects CD/MD units when several CD/MD units are connected.
During radio reception:
Changes preset groups within band received.

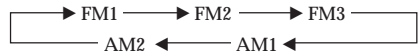

The unit cannot be operated with the wireless remote commander unless the SOURCE button on the unit is pressed or a cassette is inserted to activate the unit first.

Specifications

AUDIO POWER SPECIFICATIONS

POWER OUTPUT AND TOTAL HARMONIC DISTORTION

17 watts per channel minimum continuous average power into 4 ohms, 4 channels driven from 20 Hz to 20 kHz with no more than 1% total harmonic distortion.

Cassette player section

Tape track	4-track 2-channel stereo
Wow and flutter	0.08 % (WRMS)
Frequency response	30 – 20,000 Hz
Signal-to-noise ratio	

Cassette type	Dolby B NR	Dolby NR off
TYPE II, IV	67 dB	61 dB
TYPE I	64 dB	58 dB

Tuner section

FM

Tuning range	87.5 – 107.9 MHz
Antenna terminal	External antenna connector
Intermediate frequency	10.7 MHz
Usable sensitivity	9 dBf
Selectivity	75 dB at 400 kHz
Signal-to-noise ratio	65 dB (stereo), 68 dB (mono)
Harmonic distortion at 1 kHz	0.7 % (stereo), 0.4 % (mono)
Separation	35 dB at 1 kHz
Frequency response	30 – 15,000 Hz

AM

Tuning range	530 – 1,710 kHz
Antenna terminal	External antenna connector
Intermediate frequency	10.71 MHz/450kHz
Sensitivity	30 μ V

Power amplifier section

Outputs	Speaker outputs (sure seal connectors)
Speaker impedance	4 – 8 ohms
Maximum power output	40 W \times 4 (at 4 ohms)

General

Outputs	Power antenna control lead Power amplifier control lead Line out Rear (1) Front (1)
Tone controls	Bass \pm 8 dB at 100 Hz Treble \pm 8 dB at 10 kHz
Power requirements	12 V DC car battery (negative ground)
Dimensions	Approx. 188 \times 58 \times 181 mm (7 ¹ / ₂ \times 2 ³ / ₈ \times 7 ¹ / ₄ in.) (w/h/d)
Mounting dimensions	Approx. 182 \times 53 \times 164 mm (7 ¹ / ₄ \times 2 ¹ / ₈ \times 6 ¹ / ₂ in.) (w/h/d)
Mass	Approx. 1.2 kg (2 lb. 10 oz.)
Supplied accessories	Parts for installation and connections (1 set) Front panel case (1) Bus cable (supplied with an RCA pin cord) RC-61 (1 m), RC-62 (2 m) Wireless Remote Commander RM-X47 Rotary commander RM-X4S
Optional accessories	CD changer CDX-715 (10 discs) MD changer MDX-62 Source selector XA-C30
Optional equipment	

Design and specifications are subject to change without notice.

Troubleshooting guide

The following checklist will assist in the correction of most problems you may encounter with your unit.

Before going through the checklist below, refer to the operating procedures.

General

Problem	Cause/Solution
No sound	<ul style="list-style-type: none">• Adjust the volume with (+).• Set the fader control to the centre position for 2-speaker systems.
Indications do not appear on the display window.	Remove the front panel and clean the connectors. See "Cleaning the Connectors" in "Maintenance" for details.
No beep tone.	<ul style="list-style-type: none">• An optional power amplifier is connected to the LINE OUT and you are not using the built-in amplifier.• The beep tone is attenuated (page 10).

Tape playback

Problem	Cause/Solution
Playback sound is distorted.	Contamination of the tape head. → Clean the head.
The AMS does not operate correctly.	<ul style="list-style-type: none">• There is noise in the space between tracks.• A blank space is too short (less than four seconds).• ►► on (SEEK/AMS) is pressed immediately before the following track.• ◀◀ on (SEEK/AMS) is pressed immediately after the track starts.• A long pause, or a passage of low frequencies or very low sound level is treated as a blank space.

Radio reception

Problem	Cause/Solution
Preset tuning is not possible.	<ul style="list-style-type: none">• Store the correct frequency.• The broadcast is too weak.
Automatic tuning is not possible.	The broadcast is too weak. → Use manual tuning.
The "ST" indication flashes.	<ul style="list-style-type: none">• Tune in precisely.• The broadcast is too weak.

Disc play

Problem	Cause/Solution
Playback sound skips.	A dusty or defective disc.
Cannot turn off "-----" indication.	You cannot label MDs unless you connect a CD changer with the custom file function. → Press (FILE) for two seconds.

Error displays (when the optional CD/MD unit(s) is connected)

The following indications will flash for about five seconds and an alarm sound will be heard.

Display	Cause	Solution
NO MAG	The disc magazine is not inserted in the CD/MD unit.	Insert the disc magazine with discs into the CD/MD unit.
NO DISC	No disc is inserted in the disc magazine.	Take out the magazine and insert a disc.
NG DISCS	A CD/MD cannot play because of some problem.	Insert another CD/MD.
ERROR	The disc is dirty. The disc is inserted upside down.	Clean the disc. Insert the disc correctly.
RESET	The CD/MD unit cannot be operated because of some problem.	Press the reset button on the unit.
HI TEMP	The ambient temperature is more than 50°C.	Wait until the temperature goes below 50 °C.

EN

If the above-mentioned solutions do not help to improve the situation, consult your nearest Sony dealer.

Index

A

- ATT 9
- Automatic Music Sensor (AMS) 6, 10
- Automatic tuning 7, 8
- Automatic Tuner Activation (ATA) 6

B

- BAL (left-right) 9
- BAS (bass) 9
- Bank play 12, 13
- Beep tone 10
- Best Tuning Memory (BTM) 7
- Blank skip 6

C

- Caution alarm 4
- CD playback 10, 11, 12, 13
- Clock 5

D, E

- D-Bass 9, 10
- Disc Memo 12
- Display 5, 6, 8, 10, 12
- Dolby 6

F, G, H

- FAD (front-rear) 9
- Fast-forward 5
- Front panel 4
- Fuse 14

I, J, K

- Intro scan 6, 11

L

- Local seek mode (LCL) 8

M, N, O

- Manual search 11
- Manual tuning 7, 8
- MD playback 10, 11
- METAL 6

P, Q

- Preset search 7

R

- Radio 7, 8, 9
- Repeat play 6, 11
- Reset 4
- Rewind 5
- Rotary commander 15

S

- Shuffle play 11
- Station Memo 8, 9

T, U, V, W, X, Y, Z

- Tape playback 5, 6
- TRE (treble) 9

