

Compact Component System

Operating Instructions



CMT-101
HCD-101

WARNING

To prevent fire or shock hazard, do not expose the unit to rain or moisture.

To avoid electrical shock, do not open the cabinet. Refer servicing to qualified personnel only.

Do not install the appliance in a confined space, such as a bookcase or built-in cabinet.

US and foreign patents licensed from Dolby Laboratories Licensing Corporation.

Laser component in this product is capable of emitting radiation exceeding the limit for Class 1.

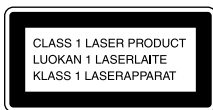

This appliance is classified as a CLASS 1 LASER product. The CLASS 1 LASER PRODUCT MARKING is located on the rear exterior.

The following label is located inside the unit.



This system is equipped with Dolby Noise Reduction* system.

* DOLBY noise reduction manufactured under license from Dolby Laboratories Licensing Corporation.

“DOLBY” and double-D symbol  are trademarks of Dolby Laboratories Licensing Corporation.

About this manual

The instructions in this manual are for the tuner CD player HCD-101, the optional MiniDisc deck MDS-MX101 and the optional stereo cassette deck TC-TX101. The instructions of the MiniDisc deck and the stereo cassette deck are only for the customers who purchased MDS-MX101 and TC-TX101.

This manual explains how to operate:

- Tuner CD player: HCD-101
- MiniDisc deck: MDS-MX101 (option)
- Stereo cassette deck: TC-TX101 (option)

Table of Contents

* For using with the optional MD deck MDS-MX101

** For using with the optional cassette deck TC-TX101

Getting Started

Step 1: Hooking up the system	4
Step 2: Setting the time	6
Step 3: Presetting radio stations	7
Connecting optional components and outdoor aerials	9

Basic Operations

Playing a CD	11
Recording a CD on an MD*	12
Playing an MD*	13
Recording a CD on a tape**	15
Playing a tape**	16
Listening to the radio	17
Receiving RDS broadcasts (European model only)	18
Recording from the radio on an MD*	19
Recording from the radio on a tape**	20

The CD Player

Using the display	22
Playing the CD tracks repeatedly	23
Playing the CD tracks in random order	24
Programming the CD tracks	25
Labelling a CD	26

The MD Deck*

– Playback	
Using the display	28
Playing the MD tracks repeatedly	29
Playing the MD tracks	
in random order	30
Programming the MD tracks	31
– Recording	
Before you start recording	32
Recording CDs by specifying the track order	33
Recording on an MD manually	34
Starting recording with 6 seconds of prestored audio data	36
Making a space between tracks	
3 seconds long	37
Marking track numbers	38
– Editing	
Before you start editing	39
Erasing recordings	40
Moving recorded tracks	42
Dividing recorded tracks	43
Combining recorded tracks	44
Undoing the last edit	45
Labelling an MD	46

The cassette deck**

Recording CDs by specifying the track order	48
Recording a CD, etc., on a tape manually	49

Sound Adjustment

Reinforcing Bass (DBFB)	51
Listening with the surround feature	52
Adjusting the balance of the speakers	52

Other Features

Labelling the preset stations	53
Falling asleep to music	54
Waking up to music	55
Timer-recording radio programmes ..	57

Additional Information

Precautions	59
System limitations of MDs*	61
Troubleshooting	62
Specifications	65
Index	67

Step 1: Hooking up the system

Do the following procedures **1** to **6** to hook up your system using the supplied cords and accessories. To complete the setup, do steps 2 and 3 also.

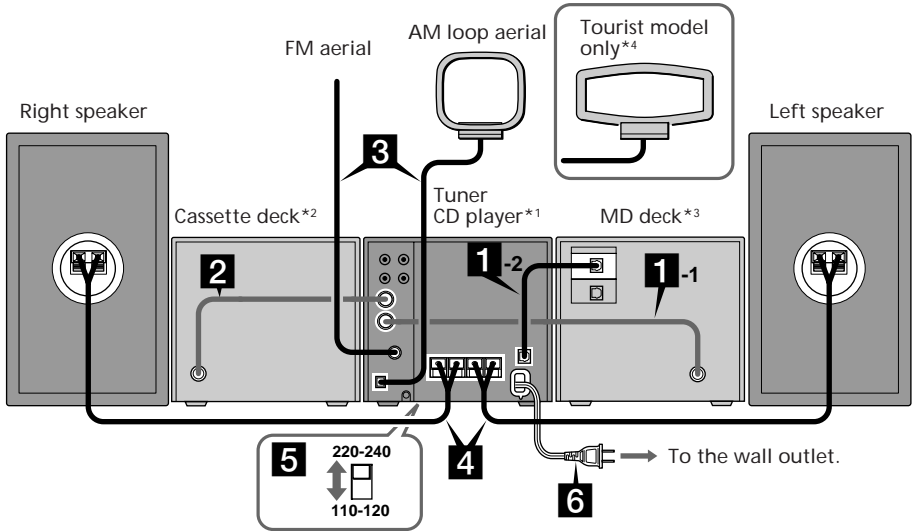

*1 CMT-101/HCD-101 consists of the CD player, the tuner and the amplifier.

*2 This is the optional cassette deck TC-TX101. Connect it to the tuner CD player if you have it.

*3 This is the optional MD deck MDS-MX101. Connect it to the tuner CD player if you have it.

*4 As for tourist model, the supplied AM loop aerial is different from the other model, but use it as the following explanation.

1 Connect the MD deck.

(for the customers who purchased MDS-MX101 only)

1 Connect the system cord of the MD deck to the MD jack of the tuner CD player.

To connect

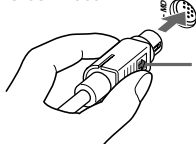

This mark should be at the right side.

To disconnect

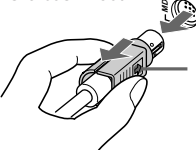

Pull this part (the outer frame) toward you. The outer frame slides toward you and comes out.

2 Connect the optical cable (supplied with MDS-MX101) to CD DIGITAL OUT of the tuner CD player and MD DIGITAL IN of the MD deck.

To connect tuner CD player

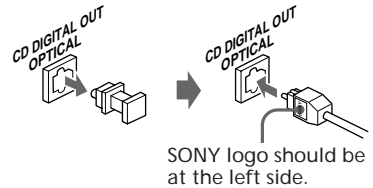

SONY logo should be at the left side.

To connect MD deck

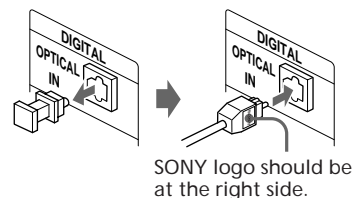

SONY logo should be at the right side.

2 Connect the cassette deck.

(for the customers who purchased TC-TX101 only)

Connect the system cord of the cassette deck to the TAPE jack of the tuner CD player in the same way as **1**-1.

3 Connect the FM/AM aerials.

FM lead aerial

The supplied FM lead aerial is the simplified aerial. For better reception, using the optional FM external aerial is recommended.

Extend the FM lead aerial up vertically as high as possible.

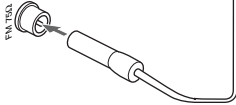

AM loop aerial

Set up the AM loop aerial, then connect it.

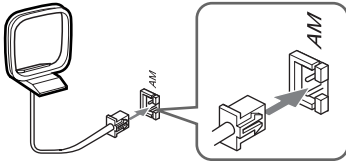

Insert the plug with the convex slot on the right into the socket until it clicks.

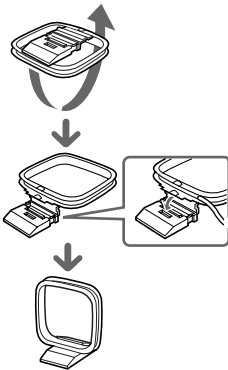

4 Connect the speakers.

Connect the speaker cords to the speaker jacks. Be sure to keep the speaker cable away from the aerials.

the rear side of the tuner CD player

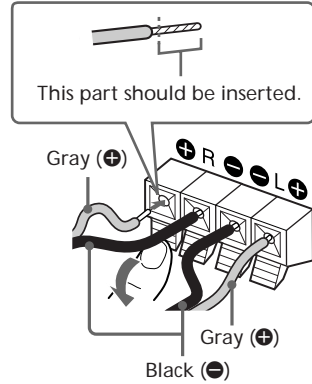

the rear side of the speaker SS-Q101/Q101A

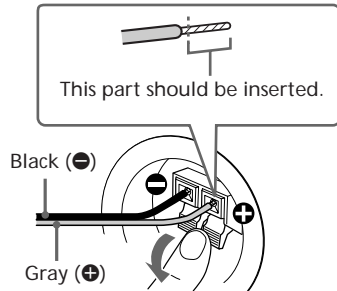

Make sure if the speaker cords are connected firmly by pulling the speaker cords lightly. When they come off, connect them again.

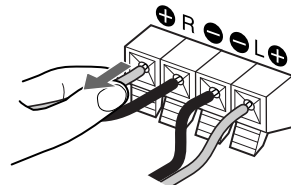

continued

Step 1: Hooking up the system (continued)

- 5** Set VOLTAGE SELECTOR to match your local power line voltage (except for European model).

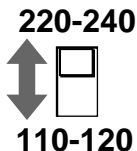

- 6** Connect the power.
Connect the mains lead of the tuner CD player to the mains after you have made all the above connections.

Inserting two R6 (size AA) batteries into the remote

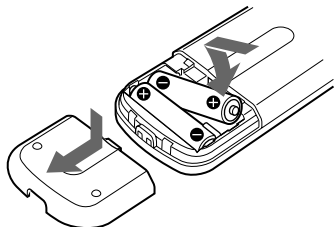

Tip

With normal use, the batteries should last for about six months. When the remote no longer operates the system, replace both batteries with new ones.

Note

If you do not use the remote for a long period of time, remove the batteries to avoid possible damage from battery leakage.

Step 2: Setting the time

Before turning on the system, you must set the time beforehand to use the timer function.

The clock is on a 24-hour system for the European model, and a 12-hour system for other models.

The European model is used for illustration purpose.

Remote (inside)

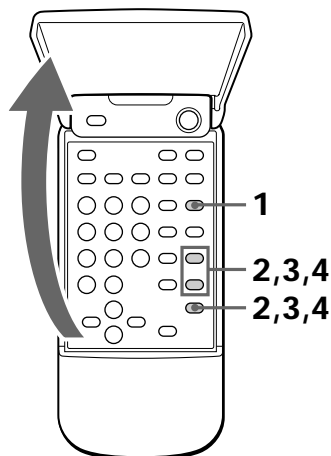

- 1** Press **TIMER SET**.

- 2** Press **TIMER +** or **-** to display "CLOCK" and press **ENTER**.
The hour indication begins flashing.



- 3** Set the current hour by pressing **TIMER +** or **-** and press **ENTER**.
The minute indication begins flashing.



-
- 4** Set the current minute by pressing **TIMER +** or **-** and press **ENTER**.
The clock starts working.
-

To correct the clock setting.
Repeat steps 1 through 4.

About the time indication

- The built-in clock shows the time in the display when power is off.
- The upper dot of the ":" in the time display flashes for the 0 to 29 seconds and the lower dot flashes for the 30 to 59 seconds.

Step 3: Presetting radio stations

The 2 band model lets you preset up to 30 stations, 20 for FM and 10 for AM. The 3 band model lets you preset up to 40 stations, 20 for FM, 10 for MW and 10 for LW.

Remote (outside)

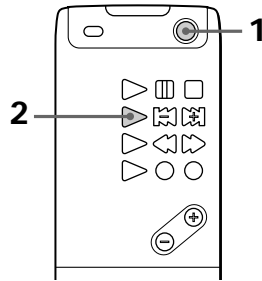

Remote (inside)

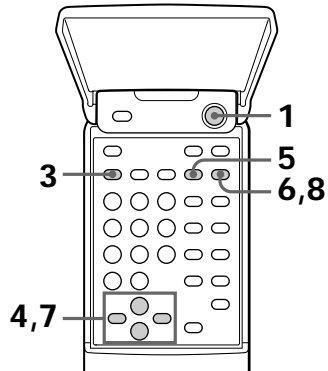

1 Press **POWER** to turn on the system.

2 Press **TUNER/BAND** repeatedly until the band you want appears in the display of the tuner CD player.

2 band model:

FM ↔ AM

3 band model:

FM → MW → LW



continued

Step 3: Presetting radio stations (continued)

-
- 3** Press TUNING MODE repeatedly until "AUTO" appears.
-
- 4** Press + or - to tune in the station you want to store.
The frequency indication changes and scanning stops when the system tunes in the station. "TUNED" and "STEREO" (for a stereo programme) appear.
-
- 5** Press EDIT/NO repeatedly until "Frq-Memory?" appears.
-
- 6** Press YES.
The preset number flashes in the display.
-
- 7** Press ← or → and select the preset number you want.
-
- 8** Press YES.
The station is stored.
-
- 9** Repeat steps 2 through 8 to store other stations.
-

To tune in a station with a weak signal

Press TUNING MODE repeatedly until "AUTO" and "PRESET" disappear in step 3, then press + or - to tune in the station.

To change the preset number

Start again from step 2.

To change the AM tuning interval (Except for European models)

The AM tuning interval is factory-preset to 9 kHz (10 kHz in some areas). To change the AM tuning interval to 10 kHz (or 9 kHz), press TUNER/BAND repeatedly until "AM" appears first, then turn off the power. While holding down +, turn the power back on.

When you change the interval, the AM preset stations will be erased. To reset the interval, repeat the same procedure.

Note

The preset stations are retained for a week even if you pull out the mains lead or if a power failure occurs.

Connecting optional components and outdoor aerials

To enhance your system, you can connect optional components. Refer to the instructions of each component.

Connecting a VCR/ personal computer

Connect a VCR/personal computer to VIDEO/PC of the tuner CD player using audio cords (not supplied).

Make sure to match the colour of the plugs and the jacks.

to the audio input of a VCR/ personal computer

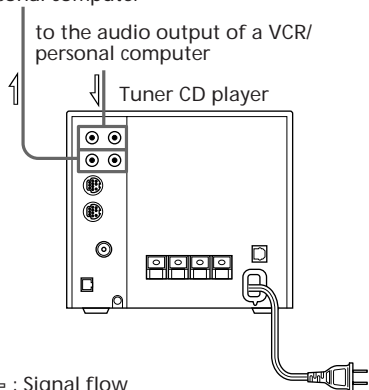

To listen to the sound

Press FUNCTION repeatedly until "VIDEO" appears. You can change the indication "VIDEO" or "PC" by pressing DISPLAY.

You can listen to the sound of connected VCR in stereo sound.

Connecting a digital equipment like a MD deck, etc.

(for the customers who purchased MDS-MX101 only)

You can record in digital sound when you connect a digital equipment to MDS-MX101. Connect the MD DIGITAL OPTICAL OUT of MDS-MX101 to the digital input of a digital equipment using the optical cable (not supplied).

to the digital input of a digital equipment

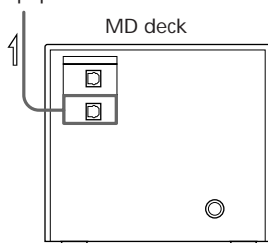

Note

This unit uses the Serial Copy Management System that allows you to make only a single copy of a recorded digital source through digital- to digital connections.

Connecting optional components and outdoor aerials (continued)

Connecting outdoor aerials

Connect the outdoor aerial to improve the reception.

FM aerial

Connect the optional FM outdoor aerial. You can also use the TV aerial instead.

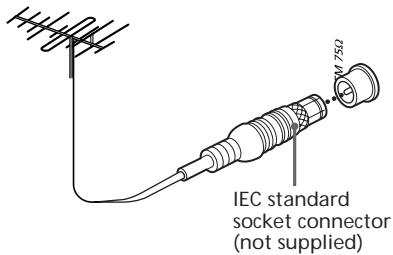

AM aerial

Leave the supplied AM loop aerial connected, and then connect the optional AM antenna to the AM antenna terminal.



Important

If you connect an outdoor aerial, ground it against lightning. To prevent a gas explosion, do not connect the ground wire to a gas pipe.

Playing a CD

Tuner CD player

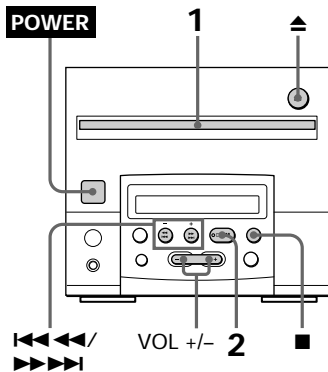

- 1 Insert a CD.
The CD is pulled in and appears.

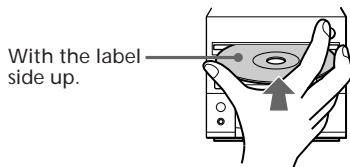

- 2 Press (CD on the remote).
The first track starts playing.

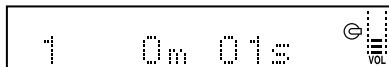

To	Do this
Stop play	Press .
Pause	Press (on the remote). Press again to resume play.
Select a track (AMS*)	Press (to go forward) or (to go back) (or on the remote).
Find a point in a track	Press or and hold on (or on the remote) and release it at the desired point.
Remove the CD	Press .
Adjust the volume	Press VOL + or -.

* AMS: Automatic Music Sensor.

Tips

- If you do not remove a CD after pressing , a CD is pulled in automatically after about 15 seconds to protect a CD.
- Inserting a CD turns the power on automatically.
- Pressing (CD on the remote) when the power is off automatically turns the power on and starts CD playback if there is a CD inside (One Touch Play).
- You can switch from another source to the tuner CD player and start playing a CD just by pressing (CD on the remote) (Automatic Source Selection).

Recording a CD on an MD

— CD Synchro Recording (for the customers who purchased MDS-MX101 only)

You can make a digital recording of a CD on an MD, marking track numbers in the same sequence as the original CD. If you use a recorded MD, the MD deck automatically locates the end of the recording and starts recording from there.

Tuner CD player

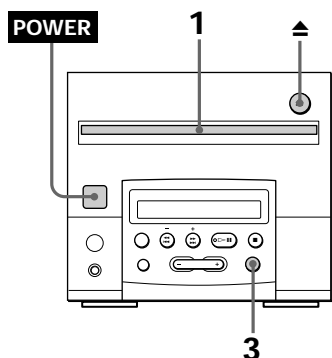

MD deck (option)

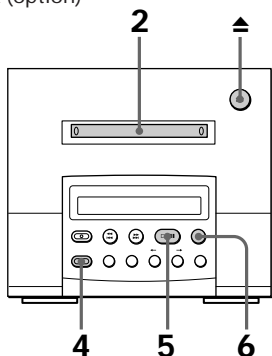

- 1 Insert a CD.
The CD is pulled in and appears.

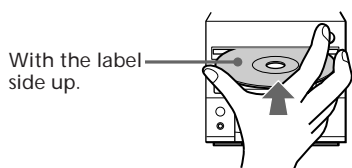

- 2 Insert a recordable MD.
The MD is pulled in and appears.

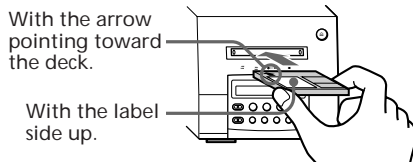

- 3 Press **FUNCTION** repeatedly until “CD” appears in the display of the tuner CD player.

- 4 Press **CD SYNC**.
The MD stands by for recording and the CD is in pause for playback.

- 5 Press **▶||** on the MD deck.
Recording starts.
When recording is finished, the MD stands by for recording and the CD stops automatically.

- 6 When recording is finished, press **■** on the MD deck to stop recording and remove the MD.
Be sure to remove an MD after recording because programme you made is put on record on an MD when an MD is removed.

To	Do this
Stop recording	Press ■ on the MD deck.
Pause	Press ▶ on the tuner CD player.
Remove the CD	Press ▲ on the tuner CD player.
Remove the MD	Press ▲ on the MD deck.

While “TOC” lights up or is flashing

Do not move the deck or pull out the mains lead to ensure the complete recording. The deck updates the Table of Contents (TOC) while “TOC” is flashing.

Tips

- You can record from a CD in the desired order (see page 33).
- You can edit the MD after recording (see page 39).

Note

You cannot perform CD synchro recording by pressing CD SYNC on both MD deck and cassette deck at the same time.

Playing an MD

(for the customers who purchased MDS-MX101 only)

You can play an MD just like a CD.

Tuner CD player

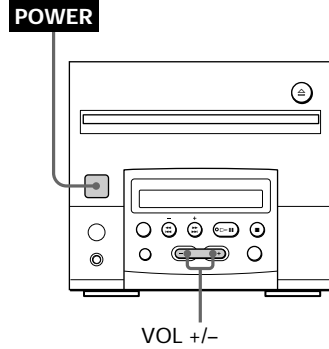

MD deck (option)

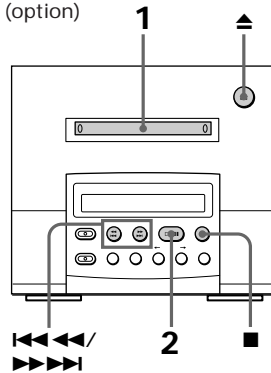

1 Insert an MD.

The MD is pulled in and  appears.

With the arrow pointing toward the deck.

With the label side up.

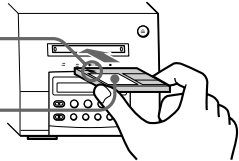

continued

Playing an MD (continued)

-
- 2** Press ►|| (MD ► on the remote).
Playback starts.
-

To	Do this
Stop play	Press ■.
Pause	Press ► (on the remote). Press again to resume play.
Select a track	Press ►►►► (to go forward) or ◄◄◄◄ (to go back) (►► or ◄◄ on the remote).
Find a point in a track	Press and hold on ►►►► or ◄◄◄◄ (◄◄ or ►► on the remote) during play and release it at the desired point.
Remove the MD	Press ▲.
Adjust the volume	Press VOL + or -.

Tips

- Inserting an MD turns on the power automatically.
- You can start playing from the desired track. Before pressing ►|| (MD ► on the remote) in step 2, press ►►►► or ◄◄◄◄ (►► or ◄◄ on the remote) repeatedly until the desired track appears.
- Pressing ►|| (MD ► on the remote) when the power is off automatically turns the power on and starts MD playback if there is an MD in the MD deck (One Touch Play).
- You can switch from another source to the MD deck and start playing an MD just by pressing ►|| (MD ► on the remote) (Automatic Source Selection).

Notes

- If the MD reaches the end while you are locating a point during sound monitoring, the deck stops.
- Tracks that are only a few seconds long may not be searched properly.
- If "OVER" appears while quickly locating a point in a track, the MD has reached the end. Press ◄◄◄◄ on the MD deck (◄◄ on the remote).

Recording a CD on a tape

— CD Synchro Recording

(for the customers who purchased TC-TX101 only)

The CD SYNC button lets you record from a CD to a tape easily. You can use TYPE I (normal) or TYPE II (CrO₂) cassette, since the tape deck automatically detects the tape type. Before recording, make sure the tabs on the cassette have not been removed.

Tuner CD player

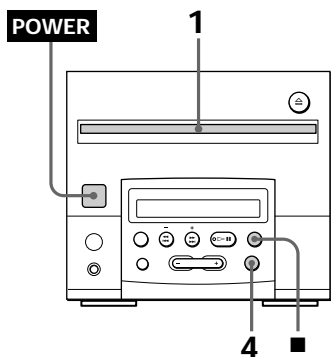

Cassette deck (option)

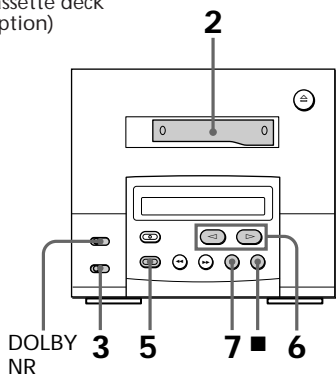

1 Insert a CD.

The CD is pulled in and  appears.

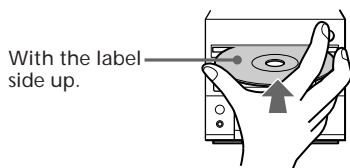

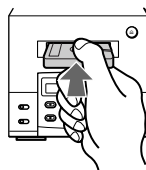

2 Insert a cassette.

The cassette is pulled in and  appears.



3 Slide DIRECTION to select dual or single-sided recording.

To record on	Slide DIRECTION to
One side	
Both sides*	



* Recording always stops at the end of the lower side. Be sure to start from the upper side.



4 Press FUNCTION repeatedly until "CD" appears in the display of the tuner CD player.

5 Press CD SYNC on the cassette deck.

The cassette deck stands by for recording, and the CD player stands by for playing.

6 Press or to select the tape side to start recording on.

To start from the upper side, press  (TAPE  on the remote).

To start from the lower side, press  (TAPE  on the remote again)*.

* Recording will be made only on the lower side.

7 Press .

Recording starts. After about 10 seconds, the CD starts playing.

continued

Recording a CD on a tape — CD Synchro Recording (continued)

To stop recording

Press **■** on the cassette deck or the tuner CD player.

Tips

- When you want to reduce the hiss noise in low-level high-frequency signals, slide the DOLBY NR switch to ON after step 3.
- If the tape reaches the end of one side during dual-sided recording, the fadeout feature works so that a track is not abruptly cut off at the end of the tape (Fade Synchro). The track will record again from the beginning of the lower side. The fadeout feature also works when you record on one side only.

Note

You cannot perform CD Synchro recording by pressing CD SYNC on both cassette deck and MD deck at the same time.

Playing a tape

(for the customers who purchased TC-TX101 only)

You can use TYPE I (normal), TYPE II (CrO₂) and TYPE IV (metal) cassettes. When you insert a cassette, the cassette deck detects the tape type and starts playing automatically.

Tuner CD player

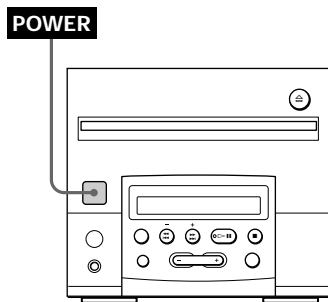

Cassette deck
(option)

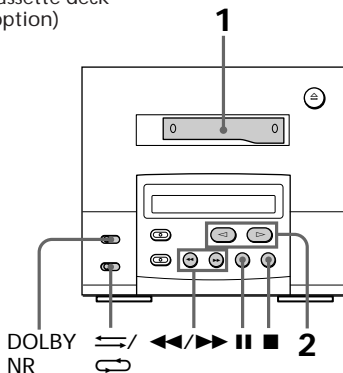

1 Insert a recorded cassette.

The cassette is pulled in and  appears.



2 Press ► to play the upper side. To play the lower side, press ◀.

To	Do this
Stop playing	Press ■.
Pause	Press II. Press again to resume play.
Find the beginning of the current or succeeding track	During play, press ◀◀ or ▶▶ on the cassette deck
Fast forward or rewind	During stop, press ◀◀ or ▶▶ on the cassette deck.
Play one side of the cassette	Slide DIRECTION to ⇄.
Play both sides repeatedly*	Slide DIRECTION to ↻.
Remove the cassette	Press ▲.

* The deck stops automatically after repeating the sequence five times.

Tips

- Pressing ► or ◀ when the power is off automatically turns the power on.
- You can switch from another source to the cassette deck just by pressing ► or ◀ (Automatic Source Selection).
- When you listen to a tape recorded with Dolby NR B, slide the DOLBY NR switch to ON.

Listening to the radio

-- Preset Tuning

Firstly preset radio stations in the tuner's memory (see page 7).

Tuner CD player

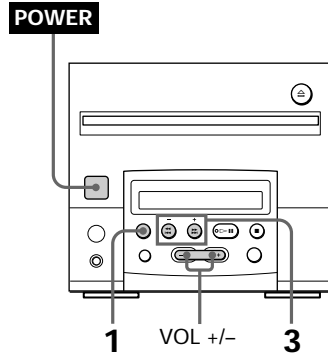

Remote (inside)

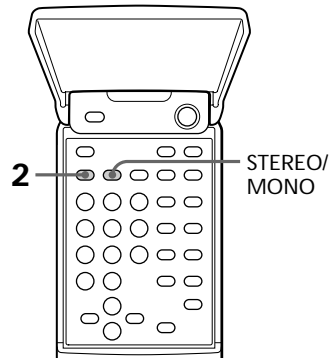

1 Press BAND repeatedly until the band you want appears.

2 Press TUNING MODE repeatedly until "PRESET" appears.

continued

Listening to the radio -- Preset Tuning (continued)

- 3** Press TUNING + or - to select the preset number you want. Press TUNING + for higher preset numbers and TUNING - for lower preset numbers.



To	Do this
Turn off the radio	Press POWER.
Adjust the volume	Press VOL + or -.

To listen to non-preset radio stations

Press TUNING MODE repeatedly until "AUTO" and "PRESET" disappears in step 2, then press TUNING + or - to tune in the desired station.

Tips

- Pressing BAND when the power is off automatically turns the power on and tunes to the last received station (One Touch Play).
- You can switch from another source to the tuner just by pressing BAND (Automatic Source Selection).
- To improve broadcast reception, reorient the supplied aerials.
- When an FM programme is noisy, press STEREO/ MONO on the remote so that "MONO" appears. There will be no stereo effect, but the reception will improve. Press the button again to restore the stereo effect.

Receiving RDS broadcasts

(European model only)

Simply select a station from the FM band. When you tune in a station that provides RDS services, the station name appears in the display.

What is the Radio Data System?

Radio Data System (RDS) is a broadcasting service that allows radio stations to send additional information along with the regular programme signal. RDS is available only on FM stations.

Note

RDS may not work properly if the station you are tuned to is not transmitting the RDS signal properly or if the signal strength is weak.

* Not all FM stations provide RDS service, nor do they provide the same types of services. If you are not familiar with the RDS system, check with your local radio stations for details on RDS services in your area.

Recording from the radio on an MD

(for the customers who purchased MDS-MX101 only)

You can record a radio programme on an MD by calling up the preset station. If you use a recorded MD, the MD deck automatically locates the end of the recording and starts recording from there.

Tuner CD player

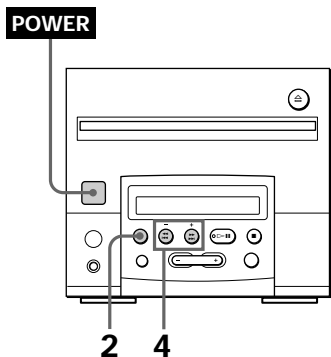

MD deck (option)

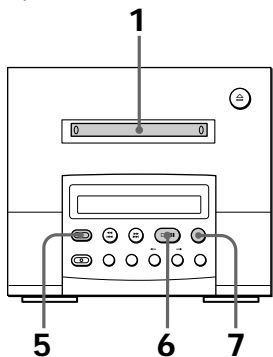

Remote (inside)

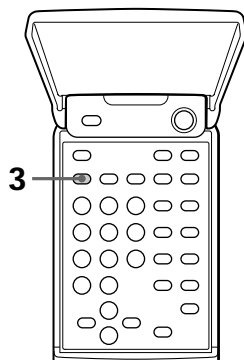

- 1 Insert a recordable MD.
The MD is pulled in and  appears.

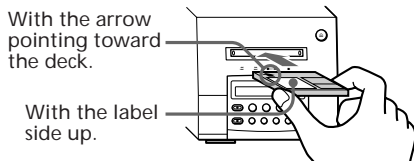

- 2 Press BAND repeatedly until the band you want appears.
- 3 Press TUNING MODE repeatedly until "PRESET" appears.
- 4 Press TUNING + or - to tune in the desired preset station.
Press TUNING + for higher preset numbers and TUNING - for lower preset numbers.
- 5 Press •REC on the MD deck.
The MD deck stands by for recording.
- 6 Press ►|| on the MD deck.
Recording starts.

continued

Recording from the radio on an MD (continued)

- 7** When recording is finished, press ■ on the MD deck to stop recording and remove the MD.

Be sure to remove an MD after recording because programme you made is put on record on an MD when an MD is removed.

To stop recording

Press ■ on the MD deck.

Tips

- To record non-preset stations, press TUNING MODE repeatedly until "AUTO" and "PRESET" disappears in step 3, then press TUNING + or - to tune in the desired station.
- To improve broadcast reception, reorient the supplied aerials.

Recording from the radio on a tape

(for the customers who purchased TC-TX101 only)

You can record a radio programme on a tape by calling up the preset station.

You can use TYPE I (normal) or TYPE II (CrO₂) cassette, since the tape deck automatically detects the tape type.

Tuner CD player

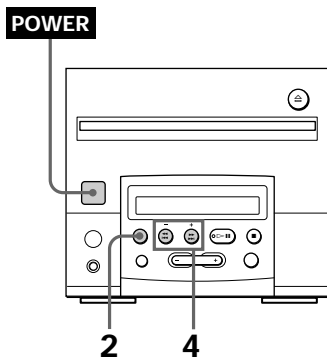

Cassette deck (option)

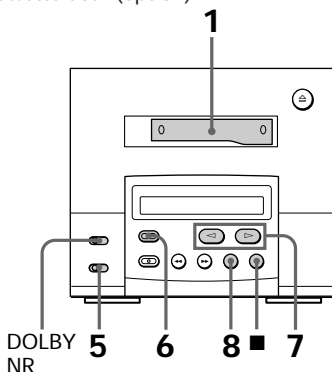

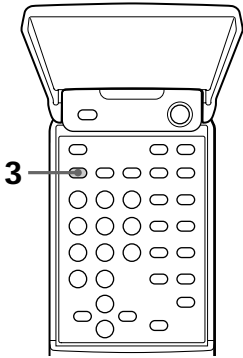

1 Insert a cassette.

The cassette is pulled in and  appears.

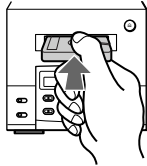



2 Press BAND repeatedly until the band you want appears.

3 Press TUNING MODE repeatedly until "PRESET" appears.

4 Press TUNING + or - to tune in the desired preset station.

Press TUNING + for higher preset numbers and TUNING - for lower preset numbers.



5 Slide DIRECTION to select dual or single-sided recording.

To record on	Slide DIRECTION to
One side	
Both sides*	

* Recording always stops at the end of the lower side. Be sure to start from the upper side.

6 Press REC on the cassette deck.
The cassette deck stands by for recording.

7 Press  or  to select the cassette side to start recording on.

To start from the upper side, press .
To start from the lower side, press .

* Recording will be made only on the lower side.

8 Press  on the cassette deck.
Recording starts.

To stop recording

Press  on the cassette deck.

Tips

- To record non-preset stations, press TUNING MODE repeatedly until "AUTO" and "PRESET" disappears in step 3, then press TUNING + or - to tune in the desired station.
- To improve broadcast reception, reorient the supplied aerials.
- When you want to reduce the hiss noise in low level high-frequency signals, slide DOLBY NR to ON after step 5.

Using the display

You can check the remaining time of the current track or that of the CD.

Remote (inside)

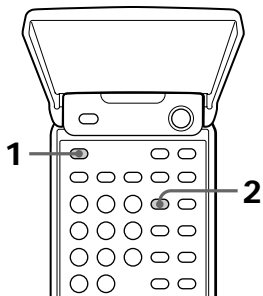

To check the total playing time and the number of tracks on the CD

1 Press FUNCTION repeatedly until "CD" appears in the display of the tuner CD player.

2 Press DISPLAY repeatedly in the stop mode.

Each time you press the button, the display changes as follows:

→ Total number of tracks, and total playing time.
↓
— Disc name*.

* If the disc name is not labelled, total number of track and total playing time appear after "No Name" appears.

To check the remaining time

Press DISPLAY repeatedly during playback.

Each time you press the button, the display changes as follows:

→ Playing time on the current track.
↓
— Remaining time on the current track.
↓
— Remaining time on the current CD.

Some displays are different from the above-mentioned in the Programme Play mode.

Playing the CD tracks repeatedly

— Repeat Play

This function lets you repeat a CD in normal play, Shuffle Play and Programme Play.

Remote (inside)

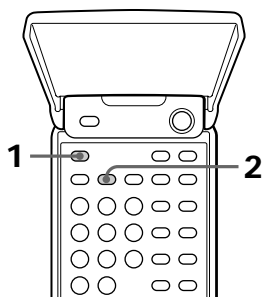

To cancel Repeat Play

Press REPEAT repeatedly “REPEAT” or “REPEAT 1” disappears.

Note

You cannot repeat a single track during Shuffle or Programme Play.

1 Press FUNCTION repeatedly until “CD” appears in the display of the tuner CD player.

2 Press REPEAT repeatedly during playback until “REPEAT” appears. Repeat Play starts.

To repeat only one track

Press REPEAT repeatedly until “REPEAT 1” appears in the display while playing the track you want to repeat.

Playing the CD tracks in random order

— Shuffle Play

You can play all the tracks in random order.

Tuner CD player

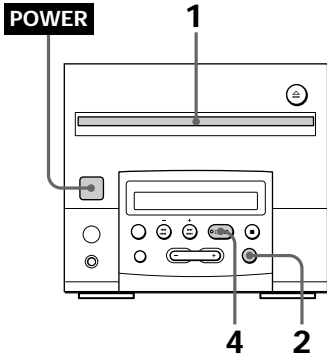

Remote (outside)

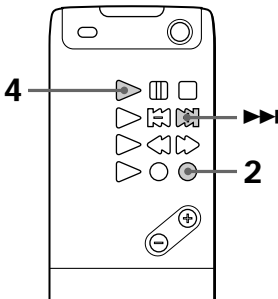

Remote (inside)

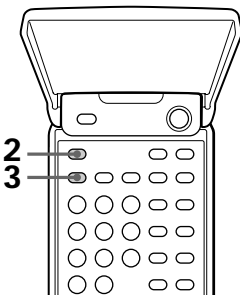

- 1 Insert a CD.
- 2 Press FUNCTION repeatedly until "CD" appears in the display of the tuner CD player.
- 3 Press PLAY MODE repeatedly until "SHUFFLE" appears.
- 4 Press ►|| (CD ► on the remote). "◀▶" appears, then all the tracks play in random order.

To cancel Shuffle Play

Press PLAY MODE repeatedly until "SHUFFLE" disappears.

Tips

- You can start Shuffle Play during normal play by pressing PLAY MODE repeatedly until "SHUFFLE" appears.
- To skip a track, press CD ►► on the remote. You cannot go back to the preceding track by pressing CD ◀◀.

Programming the CD tracks

— Programme Play

You can make a programme of up to 25 tracks from the CD in the order you want them to be played.

Tuner CD player

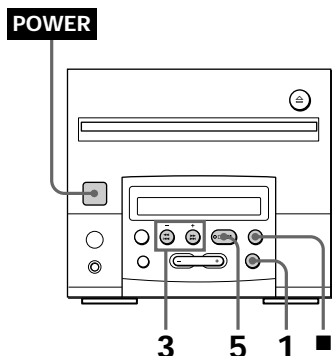

Remote (outside)

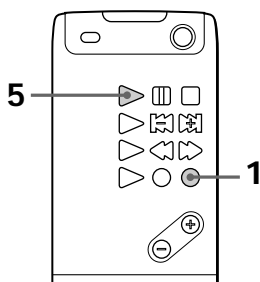

Remote (inside)

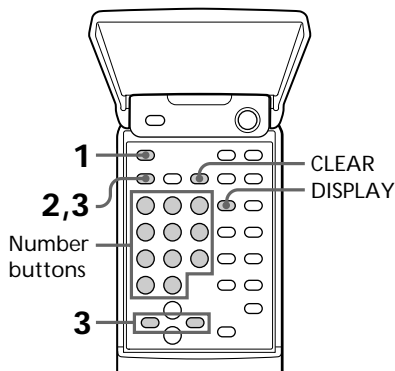

- 1 Press **FUNCTION** repeatedly until “CD” appears in the display of the tuner CD player.
- 2 Press **PLAY MODE** repeatedly until “PROGRAM” appears in stop mode.
- 3 Do either **a** or **b**.
 - a Selecting tracks with the number buttons on the remote.

Press the number buttons to enter the tracks you want to programme in the order you want.

To programme a track with a number over 11, use the >10 button.

After each step, the total playing time including the selected track and the number of total tracks appears.

If you’ve made a mistake

Press **CLEAR**, then press the correct number button.
 - b Selecting tracks while checking the total playing time
 - 1 Press **◀◀◀◀** or **▶▶▶▶** (◀ or ▶ on the remote) until the track number you want appears in the display. The total playing time including the selected track flashes in the display.
 - 2 Press **PLAY MODE**.

The step number (number of the playing order) appears for about one second, then the total playing time lights up.
- 4 Repeat step 3 to programme additional tracks.
- 5 Press **▶||** (CD ▶ on the remote).

All the tracks play in the order you selected.

To cancel the Programme Play

Press **PLAY MODE** repeatedly until “PROGRAM” disappears.

continued

Programming the CD tracks -- Programme Play (continued)

To change the programme

To	Do this
Add a track at the end of the programme*	Do steps 3 and 4 in stop mode.
Clear the entire programme	Press ■ on the tuner CD player in stop mode.
Clear the last programme	Press CLEAR. Each time you press the button, the last track of the programme is cleared.

* You can also add a track during playback when you select tracks with the number button on the remote (1 in step 3).

Tips

- The programme you made remains after the Programme Play has finished. To play the same programme again, press **▶||** (CD ▶) on the remote).
- The step number appears in the display by pressing DISPLAY in stop mode.

Notes

- The total playing time is not displayed when the total programme time exceeds 100 minutes .
- If you try to programme more than 25 tracks, "STEP FULL" is displayed.

Labelling a CD

You can label up to 35 CDs using up to 10 symbols and characters on each CDs. Whenever you insert the labelled CD, the label (disc name) appears in the display.

Tuner CD player

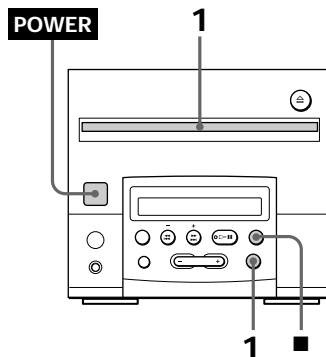

Remote (inside)

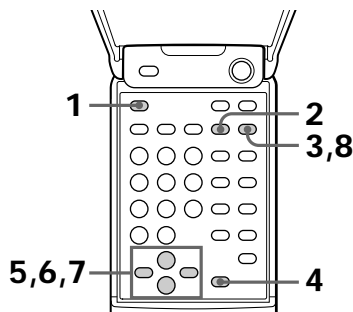

- 1 Press FUNCTION repeatedly until "CD" appears in the display of the tuner CD player, then insert a CD.
- 2 Press EDIT/NO repeatedly until "Name in ?" appears.
- 3 Press YES.
The cursor starts flashing.

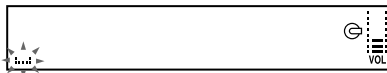

-
- 4** Press CHARACTER on the remote repeatedly until the desired type of character appears.

Each time you press the button, the display changes as follows:

A (Upper cases) → a (Lower cases) → 0
(Numbers)/! (Symbols)* → ␣ (Space)
→ A...

*You can use the following symbols.

! " # \$ % & ' () * + , - . / : ; < = > ? @ _

-
- 5** Press + or – on the remote until the desired character appears.
The selected character flashes. To enter a blank space, press → on the remote while the cursor is flashing.



-
- 6** Press → on the remote.
The character you selected in step 5 lights up and the cursor shifts to the right.

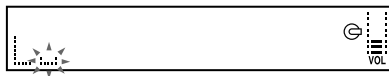

-
- 7** Repeat steps 4 through 6 to complete the entire title.
If you make a mistake, press ← or → on the remote until the character you want to change flashes, then repeat steps 4 through 6.
To erase the character, press EDIT/NO while the character is flashing.
If you try to label more than 10 character, "Name Full" is displayed.

-
- 8** Press YES to complete the labelling procedure.
The disc name is displayed.
-

To cancel labelling

Press ■.

To erase a disc name

- 1 Press EDIT/NO repeatedly until "Name Erase?" appears.
- 2 Press YES.
The disc name appears.
"No Name" appears if no disc name is stored.
- 3 Press YES again.
"Complete" appears and the disc name is erased.

Note

You can not label during playing a CD.

Using the display

(for the customers who purchased MDS-MX101 only)

You can check the remaining time and total playing time of an MD.

MD deck (option)

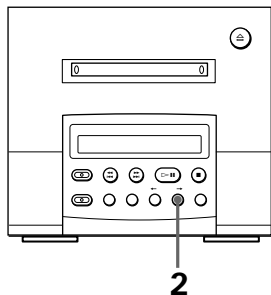

Remote (inside)

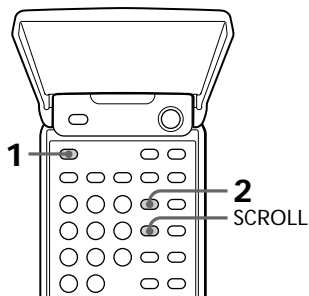

Checking the total track number, total playing time, remaining time, and disc name

1 Press FUNCTION repeatedly until “MD” appears in the display of the tuner CD player.

2 Press DISPLAY in stop mode. Each time you press the button, the display changes as follows:

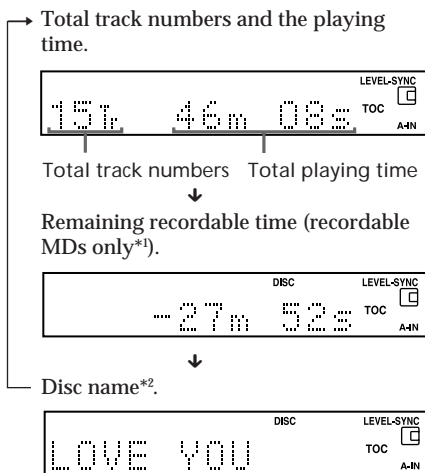

*¹ The remaining recordable time of the disc is not shown for premastered MDs.

*² “No Name” appears if no disc name is stored.

The displays are different from the above-mentioned in the Programme Play mode.

To check the remaining time of the track and track name

Press DISPLAY during playback.

Each time you press the button, the display changes as follows:

→ The track number and playing time on the current track



The track number and remaining time on the current track



Track title on the current track*

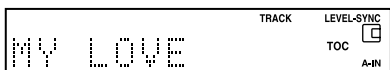

* If no track name is stored "No Name" appears for a second, then playing time appears.

Tips

- You can check the track name at any time while playing an MD by pressing SCROLL. Since the display shows up to 12 characters at a time, press SCROLL to see the rest of the track name. Press SCROLL to pause scrolling and again to continue scrolling.
- To label a track or an MD, see page 46.

Note

"-m-s" appears when a playing time exceeds 100 minutes.

Playing the MD tracks repeatedly

— Repeat Play

(for the customers who purchased MDS-MX101 only)

This function lets you repeat a single track or all the tracks on a disc.

Remote (inside)

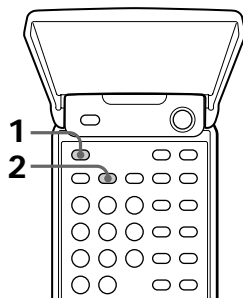

1 Press FUNCTION repeatedly until "MD" appears in the display of the tuner CD player.

2 Press REPEAT repeatedly during playback until "REPEAT" (for all the tracks) or "REPEAT 1" (for a single track) appears in the display of the MD deck.

Repeat Play starts.

* You cannot repeat a single track during Shuffle or Programme Play.

To cancel Repeat Play

Press REPEAT repeatedly until "REPEAT" or "REPEAT 1" disappears.

Playing the MD tracks in random order

— Shuffle Play

(for the customers who purchased MDS-MX101 only)

You can play the tracks in random order.

MD deck (option)

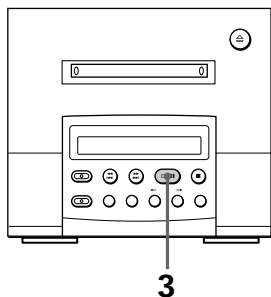

Remote (outside)

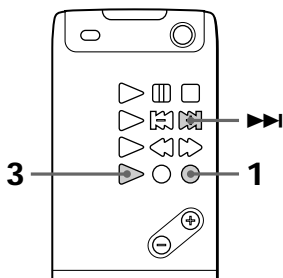

Remote (inside)

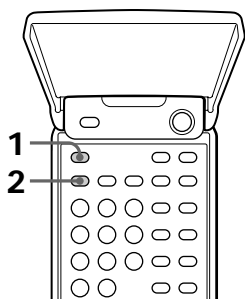

- 1 Press FUNCTION repeatedly until “MD” appears in the display of the tuner CD player.
- 2 Press PLAY MODE repeatedly in stop mode until “SHUFFLE” appears in the display of the MD deck.
- 3 Press **▶▶** (MD **▶▶** on the remote). “**☞**” appears, then all the tracks play in random order.

To cancel Shuffle Play

Press PLAY MODE repeatedly until “SHUFFLE” disappears.

Tip

To skip the tracks, press MD **▶▶▶** on the remote. You can not go back to the preceding track by pressing MD **◀◀◀**.

Programming the MD tracks

— *Programme Play*
(for the customers who purchased MDS-MX101 only)

You can make a programme up to 25 tracks in the order you want them to be played.

MD deck (option)

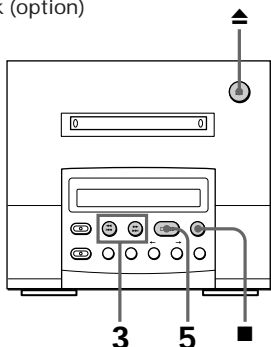

Remote (outside)

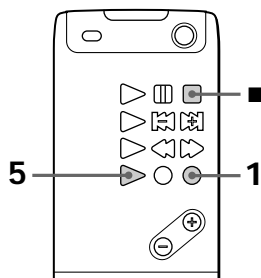

Remote (inside)

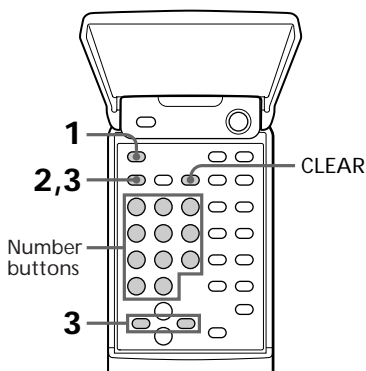

1 Press FUNCTION repeatedly until “MD” appears in the display of the tuner CD player.

2 Press PLAY MODE repeatedly in stop mode until “PROGRAM” appears in the display of the MD deck.

3 Do either **a** or **b**.

a Selecting tracks with the number buttons on the remote
Press the number buttons to programme in the order you want. To programme a track with a number over 11, use the >10 button. After each step, the total playing time including the selected track and step number appears.

If you’ve made a mistake

Press CLEAR, then press the correct number button.

b Selecting tracks while checking the total playing time

1 Press **⏮** or **⏭** (← or → on the remote) until the track number you want appears in the display. The total playing time including the selected track flashes in the display.

2 Press PLAY MODE.

The step number (number of the playing order) appears for about one second, then the total playing time lights up.

4 Repeat step 3 to programme additional tracks.

5 Press **▶||** (MD ▶ on the remote). All the tracks play in the order you selected.

To cancel the Programme Play

Press PLAY MODE repeatedly until “PROGRAM” disappears.

continued

Programming the MD tracks -- Programme Play (continued)

To change the programme

To	Do this
Add a track at the end of the programme	Do step 3 in stop mode.
Clear the entire programme	Press ■ in stop mode.
Clear the last programme	Press CLEAR. Each time you press the button, the last track of the programme is cleared.

Tip

The programme you made remains after the Programme Play has finished. To play the same programme again, press ► (MD ► on the remote).

Notes

- The programme is cleared by pressing ▲ on MD deck to eject the disc.
- "--m--s" appears when the total programme time exceeds 100 minutes.

Before you start recording

(for the customers who purchased MDS-MX101 only)

MDs (Mini Disc) let you digitally record and play back music with high quality sound that compares with the sound of CDs.

After recording

Be sure to remove an MD after recording because programme you made is put on record on an MD when an MD is removed.

About track making feature

The track making feature lets you quickly locate a specific point or easily edit the recorded tracks. However, depending on the source you record, the recording method varies.

Also, the way the track numbers are recorded differs depending on the source.

When the source you record from is:

• This system's CD player

- The digital signal from the CD is recorded as it is (digital recording¹).
- Track numbers are automatically marked as on the original CD.

• Other digital components

(e.g., a DAT deck)

- The digital signal is converted to an analog signal once, then re-converted to a digital signal and recorded² (analog recording).
- A track number is marked at beginning of recording, but when you turn on the Level Sync function (see page 38), track numbers are automatically marked in sync with the level of the input signal.

• **This unit's tuner and other analog components**

(e.g., a cassette deck)

- The analog signal is converted to digital and recorded (analog recording).
- A track number is marked at the beginning of recording, but when you turn on the Level Sync function (see page 38), track numbers are automatically marked in sync with the level of the input signal.

¹ For details on limitations of digital recording, see page 61.

² This signal conversion happens because this unit does not have digital input and output.

Recording CDs by specifying the track order

(for the customers who purchased MDS-MX101 only)

You can record tracks selected by using Programme Play function, using by CD Synchronized recording function.

Tuner CD player

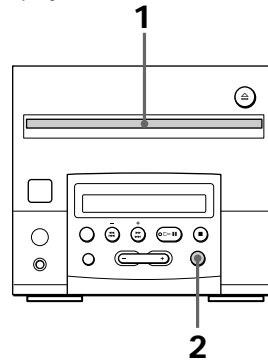

MD deck (option)

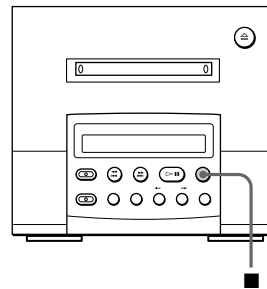

Remote (outside)

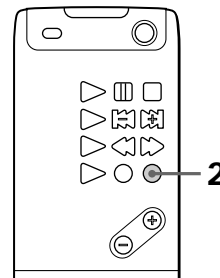

continued

Recording CDs by specifying the track order (continued)

- 1 Insert an CD.
- 2 Press FUNCTION repeatedly until "CD" appears in the display of the tuner CD player.
- 3 Make a programme of tracks from the CD.
Do steps 2 to 4 in "Programming the CD tracks" (see page 25).
- 4 Do steps 3 to 5 in "Recording a CD on an MD" (see page 12).

To stop recording

Press ■ of the MD deck.

Recording on an MD manually

(for the customers who purchased MDS-MX101 only)

The system automatically locates the last recorded portion and starts recording from that point.

MD deck (option)

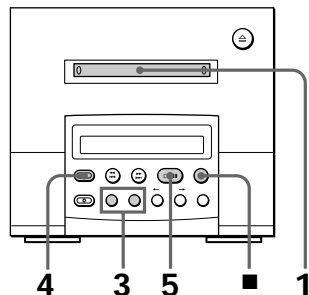

Remote (outside)

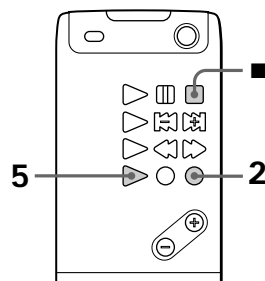

- 1 Insert a recordable MD.
- 2 Press FUNCTION and select the source you want to record.

Source	Indication
CD	CD
Radio	TUNER
Tape	TAPE
Other AV components	VIDEO or PC

When you select CD, "D-IN" appears in the display of the MD deck and the deck switches to digital recording automatically.

3 When you record in monaural sound, do as follows.

Though the sound is recorded in monaural, the time you can record becomes double. It is useful for recording of the long playing.

- 1 While the MD deck is stopped, press EDIT/NO on the MD deck until "MONO REC?" appears.
 - 2 Press YES on the MD deck. "MONO REC Y/N" appears.
 - 3 Press YES on the MD deck. "MONO" appears.
When recording stops, the sound becomes stereo sound automatically.
-

4 Press •REC on the MD deck. The deck stands by for recording.

5 Press ►|| on the MD deck (MD ► on the remote). Recording starts.

6 Start playing the source to be recorded.

To stop recording

Press ■ on the MD deck.

While "TOC" is flashing

Do not move the deck or pull out the mains lead to ensure the complete recording. The deck updates the Table of Contents (TOC) while "TOC" is flashing.

Note

If you pause recording during CD recording, a track number is recorded at that point. Also, note that the tracks are recorded as a single track with a single track number when:

- a single track of the same CD is recorded repeatedly.
- two or more tracks with the same track number from different CDs are recorded continuously.

Playing back tracks just recorded

You can listen to the tracks that have just been recorded.

Press ►|| (MD ► on the remote) immediately after stopping recording. Playback starts from the first track of the material just recorded.

To play the first track of the MD after recording

- 1 Press ■ on the MD deck again after stopping recording.
- 2 Press ►|| (MD ► on the remote).
Playback starts from the first track of the MD.

Note

If you press FUNCTION while recording, the recording will be stopped.

Tips

- You can check the recording time or remaining recordable time of the MD by pressing DISPLAY while recording.
- You can record in monaural sound by using CD synchro recording function. Do step 3 on this page before pressing CD SYNC.

Starting recording with 6 seconds of prestored audio data

—*Time Machine Recording*
(for the customers who purchased MDS-MX101 only)

When recording from an FM or satellite broadcast, the first few seconds of material are often lost due to the time it takes you to ascertain the contents and press the record button. To prevent the loss of this material, the Time Machine Recording feature constantly stores 6 seconds of the most recent audio data in a buffer memory. When you start recording the sound source, the recording actually starts with the 6 seconds of audio data stored in the buffer memory in advance, as shown in the illustration below.

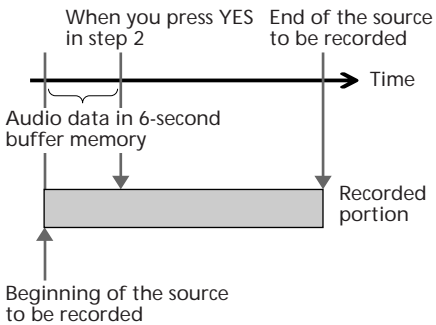

MD deck (option)

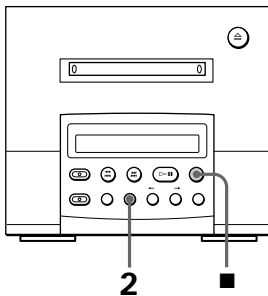

- 1 Do steps 1 to 4 in “Recording on an MD manually” on page 34.
The MD deck stands by for recording.
- 2 Press YES on the MD deck at the point you want to start recording.
Recording of the source starts with the 6 seconds of audio data stored in the buffer memory.

To stop Time Machine Recording

Press ■.

Note

The MD deck starts storing audio data when the deck is in recording pause and you start playing the source. With less than 6 seconds of playing of the source and audio data stored in the buffer memory, Time Machine Recording starts with less than 6 seconds audio data.

Making a space between tracks 3 seconds long

(for the customers who purchased MDS-MX101 only)

The Smart Space and Auto Cut functions let you make a blank space between tracks three seconds long automatically while making a digital recording.

Smart Space

There has been an extended silence of 30 seconds while digital recording.

The MD deck replaces the silence with a blank of about 3 seconds and continues recording.

Note that the tracks before and after this three-second space may be recorded as a single track with a single track number.

Auto Cut

There has been no sound input for 30 seconds while digital recording.

The MD deck replaces the silence of 30 seconds with a blank of about 3 seconds and changes to recording pause.

The Smart Space and Auto Cut functions are both turned on at the same time. You cannot use one of these functions without the other.

MD deck (option)

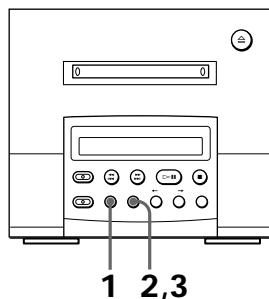

- 1** During recording pause, press EDIT/NO on the MD deck repeatedly until "S.Space?" appears.
- 2** Press YES on the MD deck within three seconds. "S. Space ON?" appears.
- 3** Press YES again. "S. Space ON" appears. When "Smart Space" appears during recording, the Smart Space function is activated. When "Auto Cut" appears, the Auto Cut function is activated.

To turn off the Smart Space and Auto Cut functions

- 1** During recording pause, press EDIT/NO repeatedly until "S. Space?" appears.
- 2** Press YES.
- 3** Press EDIT/NO so that "S. Space OFF" appears.

Notes

- The Smart Space and Auto Cut functions are factory set to on.
- If you turn the power off or disconnect the mains lead, the MD deck will recall the last setting (on or off) of the Smart Space and Auto Cut functions the next time you turn the power on.

Marking track numbers

(for the customers who purchased MDS-MX101 only)

When you record from a CD (digital recording), the track numbers are automatically marked. In addition, you can mark track numbers:

- At any point while recording.
- Automatically while recording.

Marking track numbers at a specific point while recording

- Level Syncro recording

You can mark track numbers at any time while recording, regardless of the type of sound source.

MD deck (option)

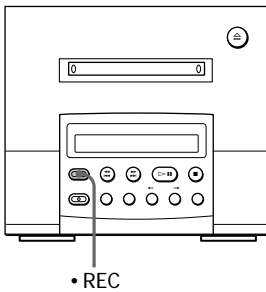

Press •REC while recording at the point you want to add a track mark.

Marking track numbers automatically while analog recording

The MD deck adds track marks differently in the following cases:

- When recording from CDs
The MD deck marks track numbers automatically. The track numbers are marked as they are found on the original.
- When recording a radio programme or from a tape

While "LEVEL-SYNC" lights up, the MD deck marks a new track number whenever the signal level drops and rises to a certain point.

If "LEVEL-SYNC" does not light up, do as follows.

MD deck (option)

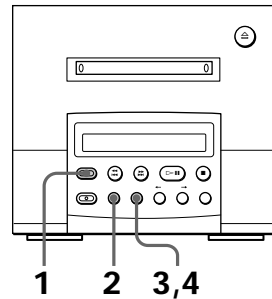

-
- 1** Press •REC.
The MD deck stands by for recording.

 - 2** Press EDIT/NO on the MD deck repeatedly until “LevelSync?” appears.

 - 3** Press YES on the MD deck.
“LevelSync ON?” appears.

 - 4** Press YES again.
“LEVEL-SYNC” lights up in the display of the MD deck.

 - 5** Start recording.
-

To cancel Auto Track Marking

Press EDIT/NO on step 4. “LEVEL-SYNC” disappears. In this way, a track number is marked only at the beginning.

Before you start editing

(for the customers who purchased MDS-MX101 only)

Be sure to remove an MD after editing because programme you made is put on record on an MD when an MD is removed.

About editing the MD

When you edit recorded tracks, there is no need for copying the MD.

- **Erase – Erasing recordings**
Use the Erase Function (see page 40). This lets you erase a single track one by one or all tracks at once.
- **Move – Changing the order tracks**
Use the Move Function (see page 42) to change the track numbering.
- **Divide – Marking track numbers on recorded radio programmes**
Use the Divide Function (see page 43) to add track numbers. This lets you find your favorite phrases quickly and play them repeatedly.
- **Combine – Combining recorded tracks**
Use the Divide and Erase Functions to erase unwanted portions, then put several phrases into a single track using the Combine Function (see page 44).
- **Undo – Canceling the last edit**
Use this function to cancel the last edit and restore the contents of the MD to the condition before the edit (see page 45).
- **Name – Labeling MDs**
Use this function to label MDs and tracks. You can use upper case, lower case, number and symbol for the titles (see page 46).

By using the editing functions in this way, you can create original MD albums.

Erasing recordings

— Erase Function

(for the customers who purchased MDS-MX101 only)

The MD system lets you erase unwanted sound quickly and easily. The three options to erase recordings are:

- Erasing a single track.
- Erasing all tracks.
- Erasing a portion of a track.

Erasing a single track

You can erase a track simply by specifying its track number. When you erase a track, the total number of tracks on the MD decreases by one and all the tracks following the erased one are renumbered.

Example: Erasing track B.

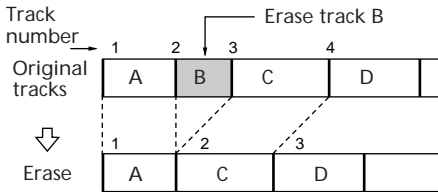

MD deck (option)

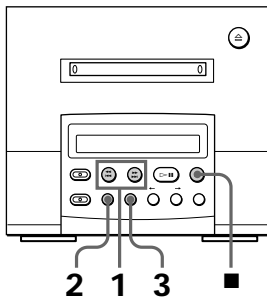

1 Press **◀◀◀** or **▶▶▶** until the track number you want appears.

2 Press **EDIT/NO** repeatedly until “Erase ?” appears in the display of the MD deck.

3 Press **YES** to erase the track. “Complete” appears for a few seconds and the selected track and title are erased. When you erase a track during playback, the track following the erased track begins playing.

4 Repeat steps 1 through 3 to erase more tracks.

To cancel erasing a track

Press **EDIT/NO** or **■** repeatedly until “Erase” disappears. Or press **◀◀◀** or **▶▶▶** to change the track number.

Note

“Erase!?” appears when the track was recorded or edited on another deck and is record protected. To erase the track, press **YES** while “Erase!?” appears.

Erasing all tracks

You can erase the disc name, all recorded tracks and their titles all at one time.

MD deck (option)

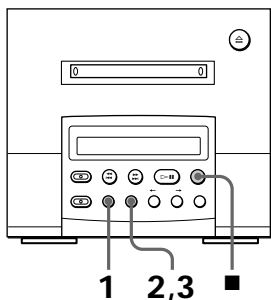

1 While the MD deck is in stop mode, press EDIT/NO repeatedly until “All Erase ?” appears in the display of the MD deck.

2 Press YES.
“All Erase??” appears.

3 Press YES again.
“Complete” appears for a few seconds and all recorded tracks and their titles are erased.

To cancel erasing all tracks

Press EDIT/NO or ■ repeatedly until “All Erase?” disappears.

Erasing a portion of a track

By using the Divide (see page 43), Erase (see page 40), and Combine (see page 44) Functions, you can erase specific portions of a track.

Example: Erasing a portion of track A.

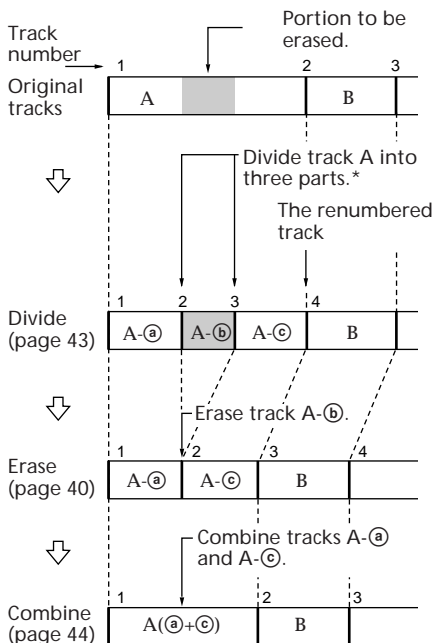

* The tracks are renumbered.

Moving recorded tracks

— Move Function

(for the customers who purchased MDS-MX101 only)

By using the Move Function, you can change the order of any track on the disc. When you move tracks, the tracks are automatically renumbered.

Example: Moving track C to position 2.

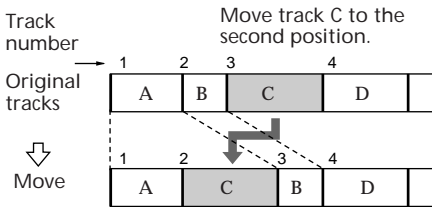

MD deck (option)

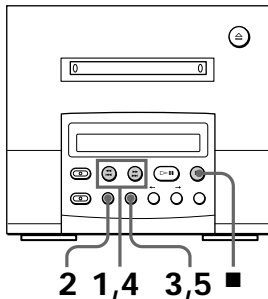

- 1 Press **◀◀◀** or **▶▶▶** until the track number you want to move appears.
- 2 Press **EDIT/NO** repeatedly until "Move ?" appears in the display of the MD deck.

- 3 Press **YES**.

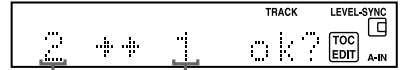

The original track number New track position

- 4 Press **◀◀◀** or **▶▶▶** until the new track position appears.

- 5 Press **YES**.

"Complete" appears for a few seconds. If you move the track while playing, the moved track start playing.

To cancel moving recorded tracks

Press **EDIT/NO** or **■**.

Dividing recorded tracks

— Divide Function (for the customers who purchased MDS-MX101 only)

You can use this function to add track numbers to multiple tracks that are recorded as one track. This function also lets you mark track numbers after the recording ends. The total number of tracks increases by one and all the tracks following the divided ones are renumbered.

Example: Dividing track 2 into tracks B and C.

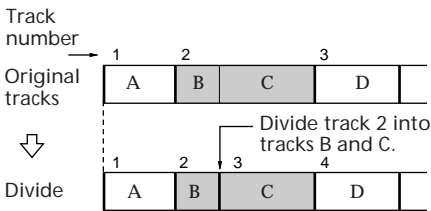

MD deck (option)

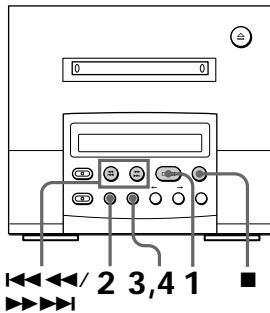

1 While playing the MD, press **▶||** at the point where you want to divide. The MD deck pauses.

2 Press **EDIT/NO** repeatedly until “Divide ?” appears.

3 Press **YES**. “Rehearsal” and “Position ok?” appear alternately and the portion to be divided is played repeatedly.

- To shift the position to be divided if the position is not proper:

1 Press **EDIT/NO**.

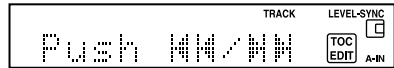

2 While monitoring the sound, press **◀◀◀** or **▶▶▶** to select the starting point to be divided.

You can check the display and shift the point between -128 and $+127$ (± 1 is about 0.06 seconds).

4 Press **YES** again when you find the point to be divided.

“Complete” appears for a few seconds and the newly created track begins playing. The new track will have no track title even if the original track was labelled.

To cancel dividing recorded tracks

Press **■**.

Dividing recorded tracks — Divide Function (continued)

Tips

- You can also divide tracks while recording. Press **•REC** at the desired point.
- To combine the divided tracks again, use Combine Function on this page.

Combining recorded tracks

— Combine Function (for the customers who purchased MDS-MX101 only)

This function lets you put several tracks or several independently recorded portions into a single track. The total number of tracks decrease by one and all the tracks following the combined ones are renumbered.

Example: Combining tracks B and C.

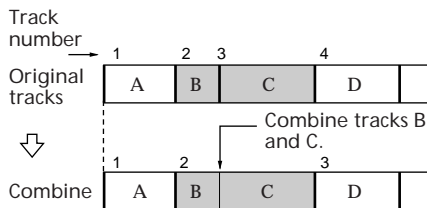

MD deck (option)

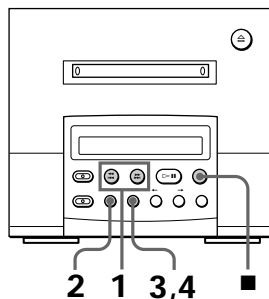

- 1** Press **◀◀◀** or **▶▶▶** until the second track of the two to be combined appears.
For example, to combine tracks 3 and 4, select track 4.
- 2** Press **EDIT/NO** repeatedly until “Combine?” appears in the display of the MD deck.

3 Press YES.

“Rehearsal” and “Track ok?” appear alternately and the portion where the two tracks will join (i.e., the end of the first track and the beginning of the second track) is played repeatedly.

If you want to cancel the combine function at this time, press EDIT/NO or ■.

4 Press YES again when you find the portion.

“Complete” appears for a few seconds and the tracks are combined.

If both of the combined tracks have track titles, the title of the second track is erased.

To cancel combining recorded tracks

Press EDIT/NO or ■.

Note

If “Sorry” appears, the tracks cannot be combined. This happens when you’ve edited the same track too many times. This is due to a technical limitation of the MD system and is not a mechanical error.

Tip

To divide the combined tracks again, use Divide Function (see page 43).

Undoing the last edit

— Undo Function

(for the customers who purchased MDS-MX101 only)

This function lets you cancel the last edit and restore the contents of the MD to the condition before the edit.

Note, however, that you cannot undo an edit if you do any of the following after the edit:

- Press •REC or CD SYNC on the MD deck.
- Update the TOC by turning the power off or ejecting the MD.
- Disconnect the mains lead.

MD deck (option)

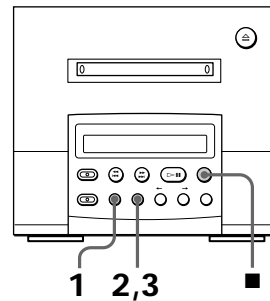

-
- 1 While the MD deck is stopped with no track number appearing in the display, press EDIT/NO repeatedly until “Undo?” appears in the display of the MD deck. “Undo?” does not appear if you have done no editing.

Undoing the last edit — Undo Function (continued)

2 Press YES.

One of the following messages appears, depending on the last edit.

Editing done:	Message:
Erasing a single track	"Erase Undo?"
Erasing all tracks on an MD	
Dividing a track	"Divide Undo?"
Combining tracks	"Combine Undo?"
Moving a track	"Move Undo?"
Labelling a track or an MD	"Name Undo?"
Changing an existing title	
Erasing all titles on an MD	

3 Press YES again.

"Complete" appears for a few seconds and the contents of the MD are restored to the condition before the edit.

To cancel the Undo Function

Press EDIT/NO or ■.

Labelling an MD

(for the customers who purchased MDS-MX101 only)

You can create titles (names) for your recorded MDs and tracks. You can use up to 1700 characters each for a disc.

Remote (outside)

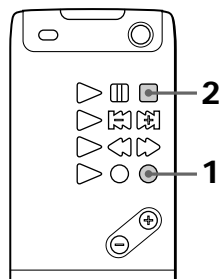

Remote (inside)

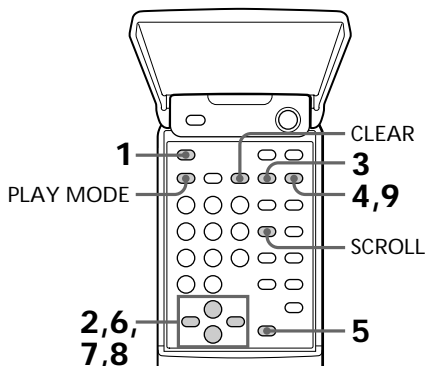

1 Press FUNCTION repeatedly until "MD" appears in the display of the tuner CD player.

2 To label a disc, press ■ and stop playing the disc.

To label a track, press → until the desired track number appears.

Note

When "SHUFFLE" or "PROGRAM" appears in the display, press PLAY MODE repeatedly until the indication disappears.

3 Press EDIT/NO repeatedly until “Name in ?” appears in the display of the MD deck.

4 Press YES.
The cursor starts flashing.



5 Press CHARACTER repeatedly until the desired type of character appears.
Each time you press the button, the display changes as follows:

A (Upper cases) → a (Lower cases) → 0 (Numbers)/! (Symbols)* → (Space) → A...

*You can use the following symbols.

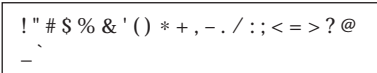

6 Press + or – until the desired character.
The selected character flashes. To enter a blank space, press **→** while the cursor is flashing.



7 Press **→** to enter the selected character.
The cursor shifts rightward and starts flashing.



8 Repeat steps 5 through 7 to complete the entire title.
If you made a mistake, press **←** or **→** until the character you want to change flashes, then repeat steps 5 to 7. To erase the character, press CLEAR while the character is flashing.

9 Press YES to complete the labelling procedure.
The titles you entered appear sequentially.

To cancel labelling

Press **■**.

To check the names

To check the disc titles, press SCROLL in stop mode. To check the track titles, press SCROLL while in playing. The titles are displayed scrolling in the display. To stop scrolling, press SCROLL. Press the button again to start scrolling.

To erase all names

- 1 Press EDIT/NO repeatedly until “Name Erase ?” appears in the display of the MD deck.
- 2 Press YES again.
“Complete” appears and all the track titles and track names are erased.

Note

You can label a track title while playing, but you must complete the labelling before the track ends.

Recording CDs by specifying the track order

(for the customers who purchased TC-TX101 only)

You can adjust the total recording time to the tape length while making a programme.

Tuner CD player

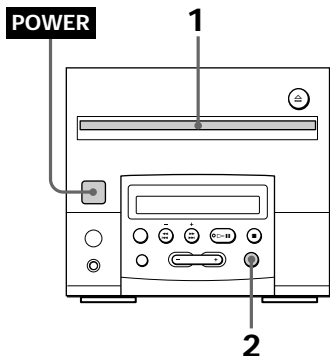

Cassette deck (option)

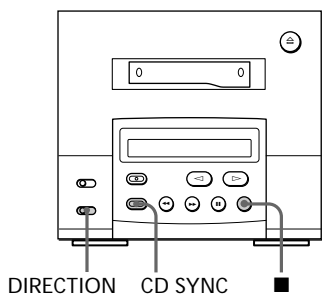

Remote (outside)

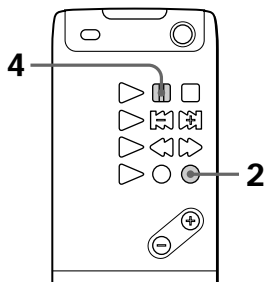

- 1 Insert a CD.
- 2 Press FUNCTION repeatedly until "CD" appears in the display of the tuner CD player.
- 3 Programme the tracks you want to record for side A.
Follow the procedure in "Programming the CD tracks-Programme Play" (see page 25).
- 4 Press **II** on the remote.
"P" appears in the display and the total playing time is reset to "0m00s".
- 5 Programme the tracks you want to record for side B in the same way as for side A.
- 6 Follow steps 3 to 6 in "Recording a CD on a tape" (see page 15).
Recording starts.
When you programme to record on both side A and B, the CD will pause after completing the recording on side A. The stereo cassette deck continues recording silence until it reaches the end of side A, then it reverses the tape and starts recording on side B. Once all of the selected tracks have been recorded, the deck records about 4 seconds of silence and then stops.

To cancel programme edit

Press ■ on the cassette deck.

Notes

- If the last portion of the track is recorded on the leader at the end of the tape, recording may not be made completely.
- When programming for side B after pausing at the end of side A, make sure the tracks programmed for side A do not exceed the length of a single side. Otherwise recording cannot be made correctly.

To start recording partway through a tape

- Play or record on the tape for more than a few seconds, then press CD SYNC. As soon as you start recording, CD starts playing.
- When you press CD SYNC after inserting a cassette, CD play will start 10 seconds after recording starts. Because the stereo system is designed to prevent recording on the leader at the beginning of the tape, this will happen even when starting recording on any other part of the tape.

Recording a CD, etc., on a tape manually

(for the customers who purchased TC-TX101 only)

You can record a CD as you like, for instance, record just the songs you want, or you can record from any point on the tape.

Tuner CD player

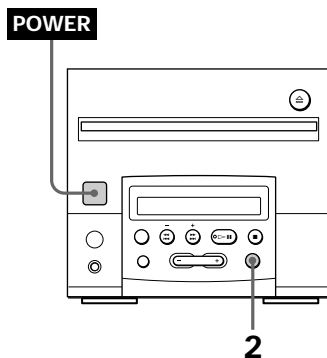

Cassette deck (option)

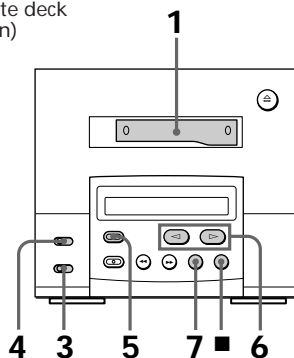

continued



Recording a CD, etc., on a tape manually (continued)

1 Insert a cassette.

2 Press FUNCTION repeatedly until the source you want to record appears in the display on the tuner CD player.

Source	Indication
CD	CD
Radio	TUNER
Optional component	VIDEO or PC
MD	MD

3 Slide DIRECTION to select dual or single-sided recording.





To record on	Slide DIRECTION to
One side	
Both sides*	



* Recording always stops at the end of the lower side. Be sure to start from the upper side.

4 When you want to reduce the hiss noise in low-level high-frequency signals, slide DOLBY NR to ON.

5 Press REC on the cassette deck.

The deck stands by for recording, and **REC** and **II** button lamp on the deck light up.

Either the  or  button lamp lights up, and the other flashes and goes out. If the  or  button lamp does not light up or flash, the corresponding tab on the cassette has been removed. You cannot record on this side.

6 Press  or  to select the tape side you want to start recording on.

To start recording on the upper side, press .

To start recording on the lower side, press .

* Record will be made only on the lower side.

7 Press **II** on the cassette deck.

Recording starts.

When you set the DIRECTION switch to , recording stops at the end of the lower side.

8 Start playing the sound source.

To stop recording

Press **II** on the cassette deck.

Note

If you press FUNCTION while recording, recording stops.

Reinforcing Bass

— DBFB

DBFB (Dynamic Bass Feedback) feature intensifies low frequency sound for richer bass reproduction.

Tuner CD player

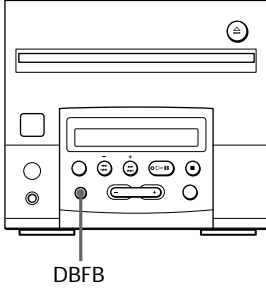

Remote (outside)

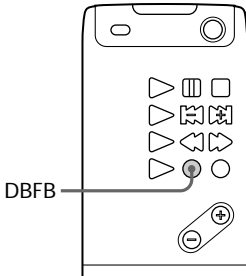

Remote (inside)

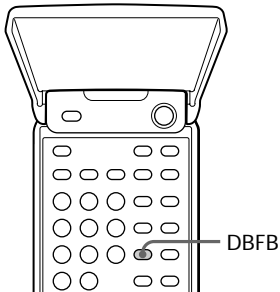

Press DBFB.

Each time you press the button, the display changes as follows:

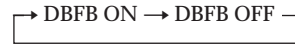

While the DBFB feature works, "DBFB" is light on in the display of the tuner CD player.

Note

When the DBFB and Surround features are set to OFF, you can enjoy almost the same sound as the CD source (Source Direct Feature).

Listening with the surround feature

With this feature you can create the atmosphere of a movie theater or concert hall.

Remote (inside)

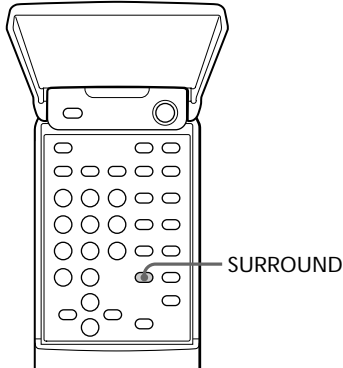

Press SURROUND.

Each time you press the button, the display changes as follows:

→ SURR ON → SURR OFF →

While the SURROUND feature works, "SURR" is light on in the display of the tuner CD player.

Note

When the Surround and DBFB features are set to OFF, you can enjoy almost the same sound as the CD source (Source Direct Feature).

Adjusting the balance of the speakers

You can adjust the balance of the sound from the speakers to correct the stereo imaging when the speaker position is not symmetrical.

Remote (inside)

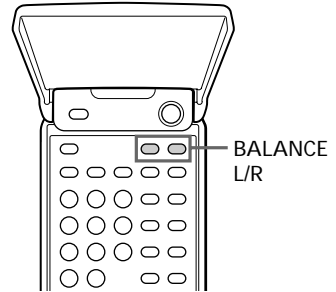

Press BALANCE L or R.

Press BALANCE R to increase the relative strength of the right speaker, and press BALANCE L to increase the relative strength of the left speaker.

Each time you press this button, the display changes as follows:

10 LEFT → 9 LEFT → → 1 LEFT →
CENTER → 1 RIGHT → 2 RIGHT → →
10 RIGHT



Labelling the preset stations

— Station Name

You can put a name of up to 10 characters (Station Name) to a preset station. The Station Name appears when you tune in the station.

Tuner CD player

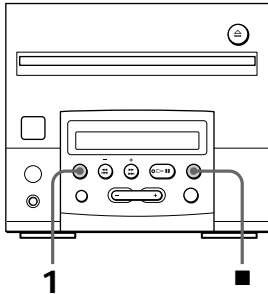

Remote (outside)

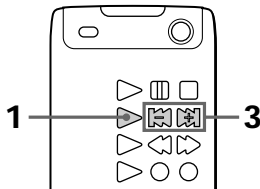

Remote (inside)

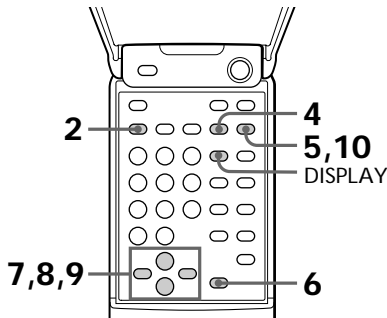

1 Press BAND (TUNER/BAND on the remote) repeatedly until the band you want appears.

2 Press TUNING MODE repeatedly until “PRESET” appears.

3 Press TUNING + or - until the preset number of the station you want to label appears.

4 Press EDIT/NO until “Name in ?” appears.

5 Press YES.
The cursor starts flashing.

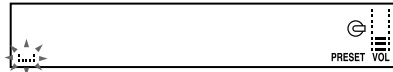

6 Press CHARACTER repeatedly until the desired type of character appears.

Each time you press the button, the display changes as follows:

A (Upper cases) → a (Lower cases) → 0 (Numbers)/! (Symbols)* → □ (Space) → A...

*You can use the following symbols.

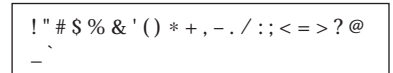

7 Press + or - on the remote until the desired character appears.

To enter a blank space, press → on the remote while the cursor is flashing.

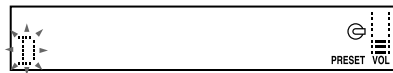

8 Press → on the remote to enter the selected character.

The cursor shifts rightward and starts flashing.

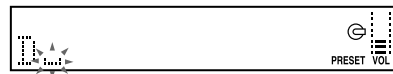

Labelling the preset stations — Station Name (continued)

- 9** Repeat steps 6 through 8 to complete the name.
If you made a mistake, press ← or → on the remote until the character you want to change flashes, then repeat steps 6 through 8. To erase the character, press CLEAR while the character is flashing.

10 Press YES.

To cancel labelling

Press ■ on the tuner CD player.

To erase the name

- 1 Repeat steps 1 to 5, then press EDIT/NO repeatedly until all the letters are erased.
- 2 Press YES.
The name is erased.

To check the labelled name

Press DISPLAY.

Each time you press the button, the display changes as follows:

Preset number and frequency range



Station name*

* If it is not labelled, it is not displayed.

Falling asleep to music

— Sleep Timer

You can let the system turn off at a preset time, so you can sleep to the music. You can preset the time to be turned off by 10 minutes. Make sure you have set the clock (see page 6).

Remote (outside)

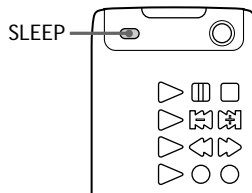

1 Play your favorite sound source.

2 Press SLEEP.

Each time you press the button, the minute display (the turn-off time) changes as follows:

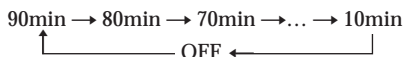

To check the remaining time

Press SLEEP once.

To change the time to turn off

Select the time you want by pressing SLEEP.

To cancel the Sleep Timer function

Press SLEEP repeatedly until “SLEEP OFF” appears.

Note

While the sleep timer is activated, the daily and recording timer function do not work.

Waking up to music

— Daily Timer

You can wake up to music at a preset time. The preset timer activates at the same time every day. Make sure you have set the clock (see page 6).

Remote (outside)

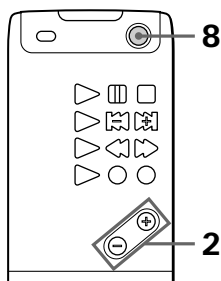

Remote (inside)

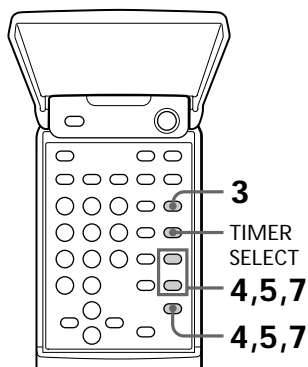

- 1 Prepare the sound source you want to play.
 - CD: Insert a CD. To start from a specific track, make a programme (see page 25).
 - MD: Insert an MD.
 - Radio: Tune in a station (see page 17).
 - Tape: Insert a cassette with the side you want to play facing up, and press ► to start playing from the upper side.

- 2 Press VOL + or - to adjust the sound volume.

- 3 Press TIMER SET.

- 4 Press TIMER + or - until “DAILY TIMER” appears, and press ENTER. The hour indication starts flashing.



- 5 Set the time to start play. Press TIMER + or - to set the hour, then press ENTER. The minute indication starts flashing.



- Press TIMER + or - to set the minute, then press ENTER. The hour indication flashes again.

Waking up to music **— Daily Timer (continued)**

- 6** Set the time to stop play following the above procedure.
A sound source flashes.
-

- 7** Press **TIMER +** or **-** until the sound source you want appears, then press **ENTER**.

The indications change as follows:

CD source ↔ TUNER source



TAPE source ↔ MD source

The start time, followed by the stop time, the sound source and volume appear, then the original display appears.

To cancel timer

Press **TIMER SET**.

When "CONNECTION" and "CHECK" flash

The source you selected (MD deck or cassette deck) is not connected correctly. Check the connection and do step 7 again.

- 8** Press **POWER** to turn off the power. The system stands by for playing. When the time to start play, the power is on and the sound source you selected starts playing. When the time to stop play, the power is off.
-

To check the setting

Press **TIMER SELECT** repeatedly until "DAILY" disappears and appears again. The start time, followed by the stop time, the sound source and volume appears then the original display appears.

To cancel the timer

Press **TIMER SELECT** repeatedly until "TIMER OFF" appears.

To change the setting

Start again from step 1.

To set the timer with the same items

Press **TIMER SELECT** until "DAILY" appears and press **POWER** to turn off the system. Once you set the timer, you do not have to set the same items again.

Timer-recording radio programmes

To timer-record, you must preset the radio station (see page 7) and set the clock (see page 6) beforehand. The timer setting will be released after the radio programme is recorded. The MD is automatically labelled with the station name, the start time and the stop time of the recording if the station is labelled (see page 53) beforehand.

Remote (outside)

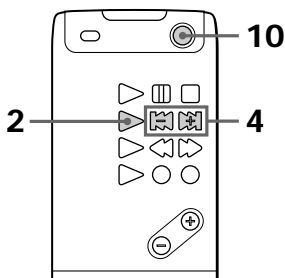

Remote (inside)

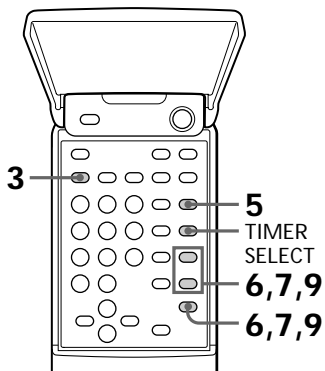

1 To record on an MD, insert a recordable MD in the MD deck. To record on a tape, insert a blank cassette in the cassette deck with the side you want to record facing up, and press **▶** to start recording from the upper side.

2 Press **TUNER/BAND** repeatedly until the band you want appears.

3 Press **TUNING MODE** repeatedly until "PRESET" appears.

4 Press **TUNING +** or **-** to tune in the preset station.

5 Press **TIMER SET**.

6 Press **TIMER +** or **-** until "REC TIMER" appears, then press **ENTER**.

The hour indication starts flashing.



7 Set the time you want to start recording.

Press **TIMER +** or **-** to set the hour, and press **ENTER**.

The minute indication flashes.



Set the minute in the same way, and press **ENTER**.

The hour indication for the turn-off time flashes.

8 Set the time you want to stop recording following the above procedure.

Timer-recording radio programmes (continued)

- 9** Press **TIMER +/-** to select what you want to record on, and press **ENTER**.

To record on a tape, display "REC to TAPE".

To record on an MD, display "REC to MD" or "REC to MD (MONO)"*.

The preset items appear in the display sequentially.

To cancel timer

Press **TIMER SET**.

When "CONNECTION" and "CHECK" flash

The source you selected (MD deck or cassette deck) is not connected correctly. Check the connection and do step 9 again.

-
- 10** Press **POWER** to turn off the power.

The system stands by for recording.

When the time to start recording, the power is on and recording starts. When the time to stop recording, the power is off and the timer is released. The volume is reduced to minimum during recording and stays the same even after recording.

* "REC to MD (MONO)": Though the sound is recorded in monaural, the time you can record becomes double.

To check the setting

Press **TIMER SELECT** repeatedly until "REC" disappears and "TIMER OFF" appears. The start time, followed by the stop time and the preset number appears, then the original display appears.

To cancel the timer

Press **TIMER SELECT** repeatedly until "TIMER OFF" appears.

To change the setting

Start again from step 1.

To set the timer with the same items

Press **TIMER SELECT** until "REC" appears and press **POWER** to turn off the system.

Once you set the timer, you do not have to set the same items again.

Note

If the recordable time for the MD comes to the end while timer recording, the recording will stop immediately, and the deck will stop.

Precautions

On safety

- The unit is not disconnected from the AC power source (mains) as long as it is connected to the wall outlet, even if the unit itself has been turned off.
- Unplug the system from the wall outlet (mains) if it is not to be used for an extended period of time. To disconnect the cord (mains lead), pull it out by the plug. Never pull the cord itself.
- Should any solid object or liquid fall into the component, unplug the stereo system and have the component checked by qualified personnel before operating it any further.
- The mains lead must be changed only at a qualified service shop.

On placement

- Place the stereo system in a location with adequate ventilation to prevent heat build-up in the stereo system.
- Do not place the unit in an inclined position.
- Do not place the unit in locations where it is;
 - Extremely hot or cold
 - Dusty or dirty
 - Very humid
 - Vibrating
 - Subject to direct sunlight.

On operation

- If the system is brought directly from a cold to a warm location, or is placed in a very damp room, moisture may condense on the lens inside the tuner CD player or the MD deck. Should this occur, the system will not operate properly. Remove the CD or MD and leave the system turned on for about an hour until the moisture evaporates.
- When you move the tuner CD player, turn off the power and disconnect the power cord after checking if the time indication is displayed. When you move the MD deck, turn off the power and disconnect the power cord after checking if all the indications disappear

If you have any questions or problems concerning your stereo system, please consult your nearest Sony dealer.

On the speaker system

Although this speaker system is magnetically shielded, there may be cases where the picture on some TV sets becomes magnetically distorted. In such a case, turn off the power of the TV set/ personal computer set once, and after 15 to 30 minutes turn it on again.

When there seems to be no improvement, locate the speaker system further away from the TV set. Furthermore, be sure not to place objects in which magnets are attached or used near the TV set, such as audio racks, TV stands, toys etc. These may cause magnetic distortion to the picture due to their interaction with the system.

Protecting a recorded MD

To record-protect an MD, slide open the tab at the side of the MD so the tab is concealed. In this position, the MD cannot be recorded. To record on the MD, slide close the tab.

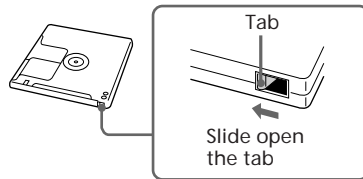

Notes on MDs

- Do not open the shutter to expose the MD. Close the shutter immediately if the shutter opens.

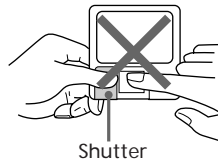

- Wipe the disc cartridge with a dry cloth to remove dirt.
- Do not expose the MD to direct sunlight or heat sources such as hot air ducts, nor leave it in a car parked in direct sunlight.

Notes on CDs

- Before playing, clean the CD with a cleaning cloth. Wipe the CD from the center out.
- Do not use solvents such as benzene, thinner, commercially available cleaners or anti-static spray intended for vinyl LPs.
- Do not expose the CD to direct sunlight or heat sources such as hot air ducts, nor leave it in a car parked in direct sunlight.

Precautions (continued)

Cleaning the cabinet

Use a soft cloth slightly moistened with mild detergent solution.

Before inserting a cassette

Take up any slack in the tape, because it may become tangled in the deck mechanism, making it unusable.

Using cassettes with extended recording time

Tapes with recording time of more than 90 minutes tend to stretch easily, so do not repeat cycles of playback, stop, fast-forward, and rewind operations, or the like. Doing so may cause the tape to become tangled in the deck mechanism.

To save a cassette permanently

To prevent a cassette from being accidentally recorded over, break off the cassette tab from side A or B as illustrated.

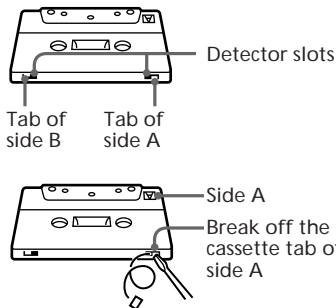

If you later want to reuse the cassette for recording, cover the broken tab with adhesive cassette.

However, be careful not to cover the detector slots which allow the tape player to automatically detect the type of cassette.

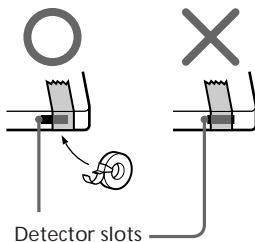

Cleaning tape heads

Clean the heads approximately once after every 10 hours of use.

If the heads become very dirty, problems such as poor sound, low volume level, drop-out in the sound, incomplete erasure of previous recording, or inability to record new material may occur. Also, make sure to clean the heads before making important recordings and after playing old cassettes. Use an optional cleaning cassette. For details, refer to the instructions provided with the cleaning cassette.

Demagnetizing the heads

Use a cassette type head demagnetizer (not supplied) to demagnetize the heads and the metal parts that come in contact with the cassette once every 20 to 30 hours of use. For details, refer to the instructions provided with the head demagnetizer.

System limitations of MDs

(for the customers who purchased MDS-MX101 only)

The recording system in your MD deck has limitations described below. Note, however, that these limitations are due to the inherent nature of the MD recording system itself and not to mechanical causes.

"Disc Full" lights up before the MD has reached the maximum recording time (60 or 74 minutes)

When 255 tracks have been recorded on the MD, "Disc Full" lights up regardless of the total recorded time. More than 255 tracks cannot be recorded on the MD. To continue recording, erase unnecessary tracks or use another recordable MD.

"Disc Full" lights up before the maximum number of tracks (255) is reached

Fluctuations in emphasis within tracks are sometimes interpreted as track intervals, increasing the track count and causing "Disc Full" to light up.

The remaining recording time does not increase even after erasing numerous short tracks

Tracks shorter than 12 seconds long are not counted, so erasing them may not increase the recording time.

Some tracks cannot be combined with others

Track combination may become impossible when tracks are shorter than 12 seconds long.

The total recorded time and the remaining time on the MD may not reach the maximum recording time (60 or 74 minutes)

Recording is done in minimum units of 2 seconds each, no matter how short the material. The contents recorded may thus be shorter than the maximum recording capacity. Disc space may also be further reduced by scratches.

The sound may drop-out while searching the edited tracks

Tracks created through editing may exhibit sound dropout during searching because high-speed playback takes time to search for the position on the disc when the tracks are scattered on the disc.

Track numbers cannot be marked properly

- When recording a CD through a digital connection, extra track numbers may be marked.
- When "LEVEL-SYNC" (page 38) is displayed during analog recording, the track numbers may not be marked at the beginning of the track:
 - if the input signal is below a certain fixed level for less than two seconds
 - if the input signal is below a certain fixed level for more than two seconds in the middle of the track.

Guide to the Serial Copy Management System

Digital audio components, such as CDs, MDs, and DATs let you copy music easily with high quality, for these digital products process music as a digital signal.

To protect the copyrighted music programmes, this unit uses the Serial Copy Management System that allows you to make only a single copy of a recorded digital source through digital-to-digital connections.

You can make only a first generation copy* through a digital-to-digital connection.

For example:

- 1 You can make a copy of a commercially available digital sound programme (e.g., a CD and an MD), but you cannot make a second copy from the first-generation copy.
- 2 You can make a copy of a digital signal from a digitally recorded analog sound programme (e.g., an analog record and a music cassette tape) or from a digital satellite broadcast programme, but you cannot make a second copy.

* A first-generation copy means a digital recording of a digital signal made on digital audio equipment. For example, if you record from this unit's CD player to this MD deck, you'd make a first-generation copy.

System limitations of MDs (continued)

Notes

- This copy management system doesn't apply when you make a recording through analog-to-analog connections.
- To make a digital recording of a digital satellite broadcast programme, whose sampling frequency is 32 kHz or 48 kHz, you need an MD deck or a DAT deck that supports these frequencies. You can also make a second-generation copy.

Troubleshooting

If you run into any problem using this stereo system, use the following check list.

First, check that the mains lead is connected firmly and the speakers are connected correctly and firmly.

Should any problem persist, consult your nearest Sony dealer.

General

There is no sound.

- Adjust the volume.
- The headphones are connected.

There is severe hum or noise.

- A TV or VCR is placed too close to the stereo system. Move the stereo system away from the TV or VCR.

"0:00" (for European model) or "12:00AM" (for other models) flashes in the display.

- A power interruption occurred. Set the clock and timer settings again.

The timer does not function.

- Set the clock correctly.

"DAILY" or "REC" does not appear even if you press TIMER SELECT.

- Set the timer correctly.

The remote does not function.

- There is an obstacle between the remote and the system.
- The remote is not pointing in the direction of the system's sensor.
- The batteries have run down. Replace the batteries.

Sound comes from one channel or unbalanced left and right volume.

- Check the speaker connection and speaker placement.
 - Press BALANCE L or R repeatedly until "CENTER" appears.
-

CD Player

The CD can not be inserted.

- Check if another CD is inserted already.

The CD can not be removed.

- Press ▲ of the tuner CD player for more than 2 seconds.

The CD will not play.

- The CD is dirty.
- The CD is inserted label side down.
- Moisture condensation has built up. Remove the CD and leave the system turned on for about an hour until the moisture evaporates.

Play does not start from the first track.

- The player is in programme or shuffle mode. Press PLAY MODE until “SHUFFLE” or “PROGRAM” disappears.

MD Deck

(for the customers who purchased MDS-MX101 only)

The programme is not recorded, which must have been recorded or edited.

- The mains lead was disconnected without removing the MD from the MD deck after recording or editing.
Be sure to remove an MD after recording or editing because programme you made is put on record on an MD when an MD is removed.

The MD can not inserted.

- Check if another MD is inserted already.

The controls do not work.

- The MD is dirty or scratched. (“Disc Error” appears.) Replace the MD with a new one.

The MD will not play.

- Moisture condensation has built up. Remove the MD and leave the system turned on for several hours until the moisture evaporates.
- Insert the MD in the direction of the arrow.
- Nothing is recorded on the MD.

Recording is not possible.

- The MD is protected against erasure. (“MD Protected” appears.) Slide the tab to close the slot (see page 59).
- Connect the sound source properly.
- A premastered MD is inserted in the deck. Replace the disc with a recordable MD.
- Replace the disc with a recordable MD that has sufficient time remaining or erase unnecessary tracks.
- The mains lead was unplugged or a power interruption occurred during recording. Start recording over from the beginning.

Cassette deck

(for the customers who purchased TC-TX101 only)

The cassette can not be inserted.

- Check if another cassette is inserted already.

Recording is not possible.

- The tab on the cassette is broken off. Cover the broken tab with adhesive tape.
- The tape has reeled to the end.

CD Synchronized recording does not start.

- When you set DIRECTION to ⇄, recording does not start if the tab of either side is removed from the cassette.

The sound is not clear and there is a decrease in sound level.

- The heads are dirty. Clean them.
- Magnetic deposits have built-up on the record/playback head. Clean them.

The sound drops out.

- The capstans or pinch rollers are contaminated. Clean them.

continued

Troubleshooting (continued)

Tuner

Severe hum or noise ("TUNED" or "STEREO" flashes in the display).

- Adjust the aerial.
- The signal strength is too weak. Connect the external aerial.

A stereo FM programme cannot be received in stereo.

- Press STEREO/MONO so that "STEREO" appears.

MD messages

(for the customers who purchased MDS-MX101 only)

One of the following messages may appear or flash in the display window during MD operation.

Auto cut

The MD deck is pausing the recording because silence continued for 30 seconds or more during digital recording.

Blank Disc

The inserted recordable MD is brand new or all tracks on the MD have been erased.

Cannot Copy

You cannot make a digital recording (See "Guide to the Serial Copy Management System" on page 61).

Cannot Edit

You tried to edit in Programme or Shuffle Play mode.

CHECK OPT-IN

The digital signal input was interrupted during recording. Connect the optical cable securely (see page 4).

Disc Error

The inserted MD is damaged or does not contain a TOC.

Disc Full

There is no time remaining on the disc (See "System Limitations of MDs" on page 61).

Impossible

You tried to combine from the first track on an MD, which is not possible.

Name Full

There is no more space to store track or disc titles.

NO DISC

There is no MD in the MD deck.

Protected

The inserted MD is protected against erasure.

Rec Level Over

A high-level signal was input during analog recording with VIDEO/PC input jack.

Adjust the level of the connected equipment.

Retry

The MD deck is redoing the recording because of vibrations or disc scratches encountered during recording.

Retry Error

Due to vibration affecting the MD deck or scratches on the MD, several recording attempts were made but with no success.

Smart Space

The signal was input again after silence continued for 3 to 30 seconds or less during digital recording.

Sorry

You tried to combine tracks that cannot be combined.

Specifications

Tuner CD player (HCD-101)

Tuner section

Tuning range

2 band model

European model: FM: 87.5 – 108 MHz
(50 kHz step)

Other models: AM: 522 – 1,611 kHz
FM: 87.5 – 108 MHz
(76.0 – 108.0 MHz)*
(50 kHz step)

AM: 531 – 1,602 kHz
(at 9 kHz interval)
530 – 1,710 kHz
(at 10 kHz interval)

* For customers who purchased the unit in Japan.

3 band model

FM: 87.5 – 108 MHz
(50 kHz step)
MW: 522 – 1,611 kHz
(at 9 kHz interval)
LW: 144 – 288 kHz
(at 3 kHz interval)

Intermediate frequency

FM: 10.7 MHz

AM: 450 kHz

Aerial terminals

FM: 75 ohm unbalanced

AM: External aerial

terminal

Timer

Quartz lock system

Timer setting

One-minute step

Sleep timer

10-minute step, max.
90 minutes

CD player section

System

Compact disc digital
audio system

Laser

Semiconductor laser
($\lambda = 780$ nm)

Laser output power

Less than 44.6 μ W*

* This output is the value measured at a distance of
200 mm from the objective lens surface on the
optical pick-up block with 7 mm aperture.

Frequency response

5 Hz – 20 kHz

Signal to noise ratio

More than 90 dB

Harmonic distortion

Less than 0.05%

Amplifier section

European model

DIN power output 15 + 15 watts (4 ohms at
1 kHz, DIN)

Continuous RMS power output

21 + 21 watts (4 ohms at
1 kHz, 10% THD)

Music power output

26 + 26 watts

Other model

Rated RMS power output

16 + 16 watts (4 ohms at
1 kHz, 1% THD,
AC 240 V/AC 120 V)

Reference RMS power output

22 + 22 watts (4 ohms at
1 kHz, 10% THD,
AC 240 V/AC 120 V)

Inputs

VIDEO/PC IN jack:

Stereo phone jacks,
sensitivity 500 mV,
impedance 47 kilohms

Outputs

VIDEO/PC OUT jack:

Stereo phone jacks,
250 mV, 1 kohm
DIGITAL OUT (CD
OPTICAL OUT):

Square optical connector
jack, -18 dBm, wave
length 660 nm

PHONES (headphones)

jack:

Stereo mini jack, accepts
headphones of 8 ohms or
more.

General

Power requirements

European model

220 – 230 V AC, 50/60 Hz

Other models

110 – 120 V or 220 – 240 V

AC, 50/60 Hz adjustable
with voltage selector

Power consumption

66 W (when connected to
TC-TX101, MDS-MX101)

Dimensions

Approx. 142 × 125 ×
260 mm (w/h/d) incl.
projecting parts and
controls

Mass

Approx. 4.1 kg

continued

Specifications (continued)

Speaker system (SS-Q101/Q101A)

Speaker system	2-way bass reflex (magnetically shielded design)
Speaker units	10 cm dia., cone type 2 cm dia., balance drive type
Rated impedance	4 ohms
Dimensions	Approx. 125 × 205 × 197 mm (w/h/d) incl. projecting parts and controls
Mass	Approx. 1.9 net per speaker kg

Supplied accessories

- Sony RM-SQ101 Remote (1)
- R6 (size AA) batteries (2)
- AM loop aerial (1)
- FM lead aerial (1)
- Speaker cord (2)

Design and specifications are subject to change without notice.

Index

A

- Adjusting
 - the sound 51
 - the volume 11
- AMS 11
- Analog recording 33
- Aerials 5, 10
- Auto cut 37
- Automatic Source Selection 11, 14, 17

B

- Batteries 6

C

- CD player 11, 22
- CD Synchro Recording 12
- Clock setting 6
- Combine Function 43
- Connecting. *See* Hooking up

D

- Daily timer 55
- DBFB 51
- Digital recording 32
- Display 22, 28
- Divide Function 43

E, F, G

- Erase Function 40
- Erasing
 - a portion of a track 41
 - a single track 40
 - all tracks on an MD 41
 - recordings 40

H, I, J, K

- Hooking up
 - optional components 9
 - the aerials 5, 10
 - the power 6
 - the system 4

L, M, N

- Labelling
 - a CD 26
 - an MD 46
 - a preset station 53
- MD messages 64

O

- One Touch Play 11, 14, 18

P, Q

- Playing
 - a CD 11
 - an MD 13
 - a tape 16
 - a preset radio station 17
 - tracks in random order (Shuffle Play) 24, 30
 - tracks in the desired order (Programme Play) 25, 31
 - tracks repeatedly (Repeat Play) 23, 29
- Presetting radio stations 17
- Preset tuning 7
- Programme Play 25, 31
- Protecting recordings 59

R

- Radio stations
 - presetting 17
 - tuning in 7
- Recording
 - a CD 12, 15
 - a radio programme 19, 20
 - on an MD 12, 19
 - on a tape 15, 20
 - timer recording 57
- Repeat Play 23, 29

S

- Saving recordings 60
- Setting the time 6
- Serial copy management system 61
- Shuffle Play 24, 30, 54
- Sleep Timer 54
- Smart Space 37
- Sound adjustment 51
- Speakers 5
- Station Name 53
- System limitations 61

T, U, V, W, X, Y, Z

- Timer
 - falling asleep to music 54
 - timer recording 57
 - waking up to music 55
- Track numbers 38
- Track marking 38
- Troubleshooting 62