

Radio Cassette-Corder

Operating Instructions

CFS-KW77S

Warning

To prevent fire or shock hazard, do not expose the player to rain or moisture.

To avoid electrical shock, do not open the cabinet. Refer servicing to qualified personnel only.

Warning

Do not install the appliance in a confined space, such as a bookcase or built-in cabinet.

The FUNCTION selector is located at the front panel.

When you turn on the player, the OPR/BATT indicator lights up.

Table of contents

Basic Operations

- 4 Listening to the radio
 - 6 Playing a tape
 - 8 Recording
 - 10 Dubbing (deck A to B)
 - 12 The KARAOKE
-

The Tape Player

- 14 Finding the beginning of a track (AMS)
- 14 Playing both decks in succession

Setting Up

- 15 Hooking up the system
- 17 Connecting optional components
- 18 Adjusting the audio emphasis (DYNAMIC SOUND SYSTEM)

Additional Information

- 19 Precautions
- 20 Troubleshooting
- 21 Maintenance
- 22 Specifications
- 23 Index

Listening to the radio

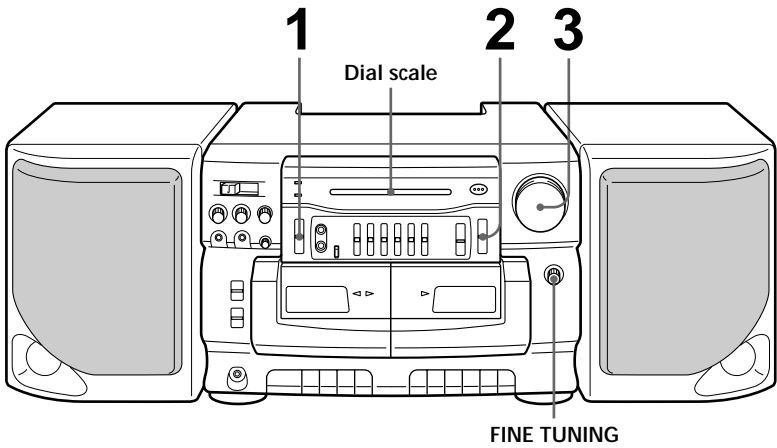

For hookup instructions, see pages 15 - 16.

1

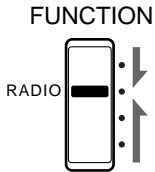

Set FUNCTION to RADIO.

2

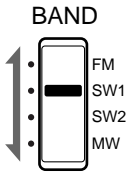

Set BAND to the band you want.

3

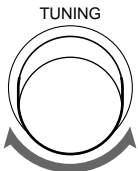

Turn TUNING to tune in to a radio station.

To tune in an SW station, use FINE TUNING for better SW reception.

FINE TUNING



Use these buttons for additional operations

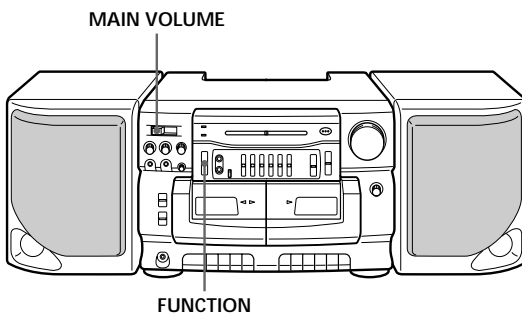

Tips

- To listen through the headphones, connect the headphones to the PHONES (headphones) jack.

To	Do this
Adjust the volume	Slide MAIN VOLUME
Turn off the radio	Set FUNCTION to TAPE (RADIO OFF)

To improve broadcast reception

Reorient the antenna for FM. Reorient the player itself for MW. For SW, pull the antenna vertically.

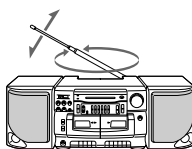

For FM

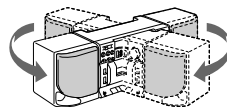

For MW

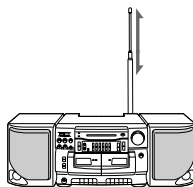

For SW

Playing a tape

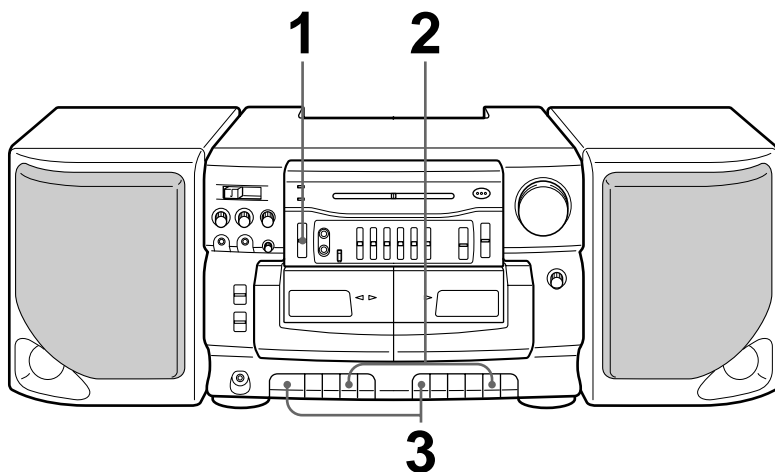

For hookup instructions, see pages 15 - 16.

1

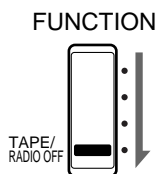

Set **FUNCTION** to **TAPE/RADIO OFF**.

2



Press **STOP/EJECT** to open the tape compartment and insert a recorded tape into deck A or B. Close the compartment.

With the side you want to play facing forward

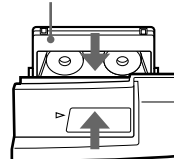

3

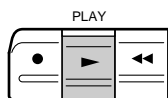

Press **PLAY**.

Use these buttons for additional operations

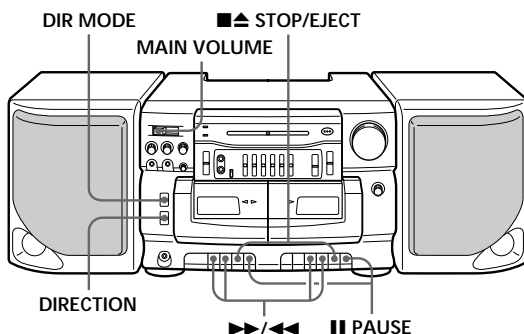
**Note**

During playback, do not press buttons on the other deck. Otherwise the playback speed may change.

Tips

- For the best results, use TYPE I (normal) tape.
- When you play both decks, you will hear only deck B.

To	Do this
Adjust the volume	Slide MAIN VOLUME
Stop playback	Press ■▲ STOP/EJECT
Fast-forward or rewind the tape	Press ►► or ◀◀
Pause playback	Press PAUSE Press the button again to resume play after pause.
Play the opposite side of the tape (deck A only)	Press DIRECTION The ► or ◀ indicator shows the tape direction of deck A.
Eject the cassette	Press ■▲ STOP/EJECT

To select the direction of the tape (deck A only)

To play	Switch DIR MODE to
Both sides of the tape repeatedly	↻
Both sides of the tape from the front side to reverse side only*	↺

* If play begins from the reverse side, the tape stops at the end of that side.

Recording

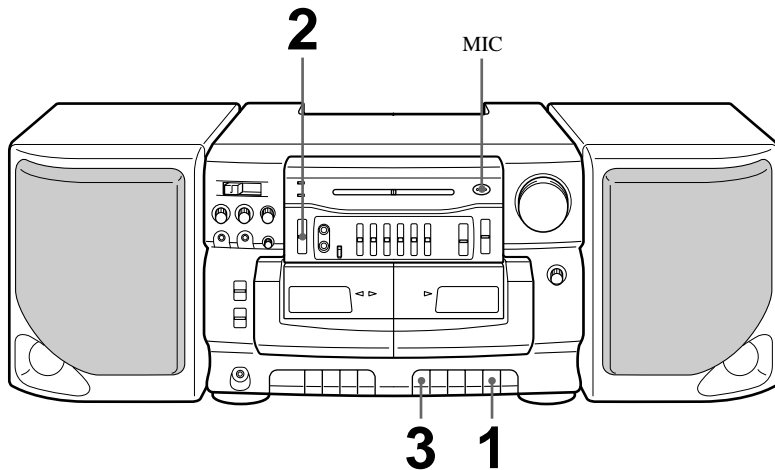

For hookup instructions, see pages 15 - 16.

1

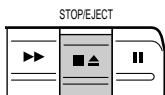

Press **■▲** STOP/EJECT to open the tape compartment on deck B and insert a blank tape. Use TYPE I (normal) tape only.

With the side you want to record on facing forward

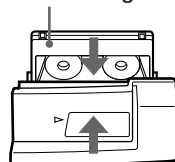

2

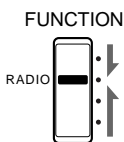

Select the program source you want to record.

To record from the radio, set FUNCTION to RADIO and tune in to the station you want (see page 4).

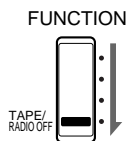

To record from the built-in microphone, set FUNCTION to TAPE (RADIO OFF).

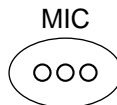

3

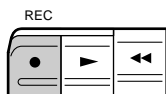

Press **●** REC on deck B. (▶ PLAY is depressed automatically).

Tips

- For the best results, use the AC power as a power source for recording.
- Adjusting the volume or the audio emphasis will not affect the recording level.
- To erase a recording, proceed as follows;
 - 1 Disconnect the audio source if connected to the CD/TV LINE IN jack.
 - 2 Set FUNCTION to CD/TV LINE IN.
 - 3 Press ●REC on deck B.

Notes

- You cannot listen through the headphones when recording from the built-in microphone.
- When you connect the microphone to the MIX MIC jack, you cannot record from the built-in microphone.

Use these buttons for additional operations

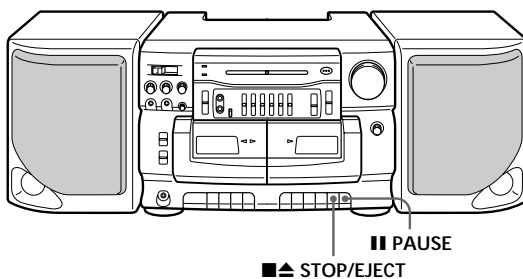

To	Press
Stop recording	■▲ STOP/EJECT When the tape ends, the recording stops.
Pause recording	PAUSE Press the button again to resume recording.

Dubbing (deck A to B)

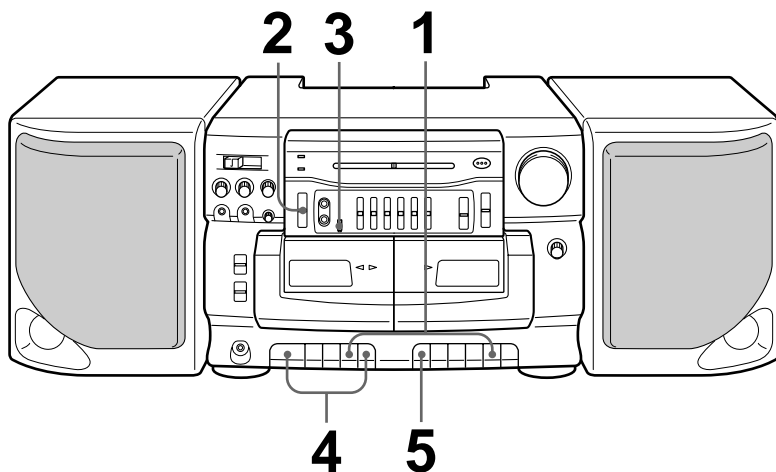

For hookup instructions, see pages 15 - 16.

1

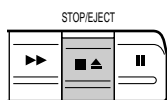

Press **■▲** STOP/EJECT to open the tape compartment on both decks. Insert a recorded tape into deck A and a blank tape into deck B. Use TYPE I (normal) tape only.

With the side you want to record on facing forward

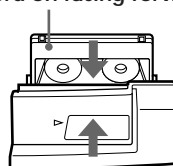

2

FUNCTION

Set FUNCTION to DUBBING.

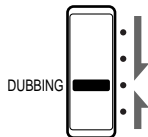

3

HIGH SPEED DUBBING

ON
 OFF

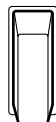

Press HIGH SPEED DUBBING. To dub at high speed; Press HIGH SPEED DUBBING to ON. To dub at normal speed; Press HIGH SPEED DUBBING to OFF.

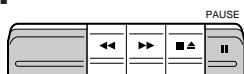
4 Deck A

Press **|| PAUSE** and then press **▶ PLAY** on deck A.

5 Deck B

Press **● REC** on deck B.
(**▶ PLAY** is depressed automatically).

Tips

- For the best results, use the AC power as a power source for recording.
- Adjusting the volume or the audio emphasis will not affect the recording level.
- To dub at high speed, press **HIGH SPEED DUBBING (ON)** before you start dubbing. Do not press **HIGH SPEED DUBBING** during dubbing as this causes excessive wow and flutter.
- When the tape in deck A ends first, deck B will also stop recording. When the tape in deck B ends first, deck A plays on as set with the **DIR MODE** switch.

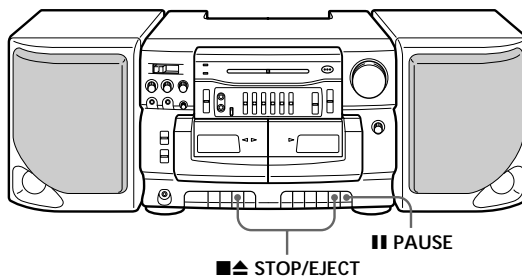
Use these buttons for additional operations

To	Press
Stop dubbing	■▲ STOP/EJECT on deck B, then on deck A
Pause dubbing	 PAUSE on deck B Press the button again to resume dubbing

The KARAOKE

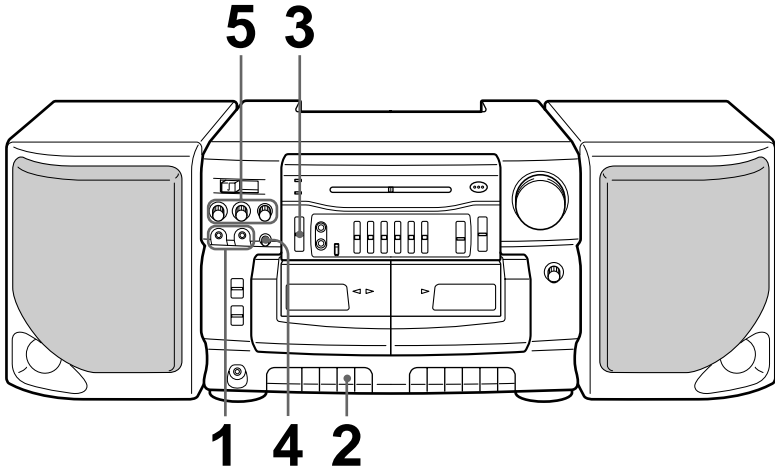

For hookup instructions, see pages 15 - 16.

1



Plug the microphone (supplied) into the MIX MIC jack and turn on the microphone.

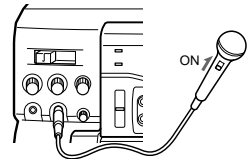

2

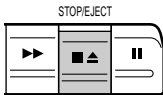

Prepare a sound source.

To use KARAOKE multichannel tapes, insert the tape.

With the side you want to play facing forward

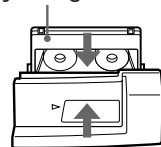

To use KARAOKE multichannel CDs, connect a CD player to the CD/TV LINE IN jack (see page 17).

3

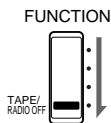

Set FUNCTION to match the sound source.

When using tapes, set FUNCTION to TAPE/RADIO OFF.

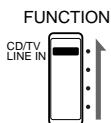

When using CDs, set FUNCTION to CD/TV LINE IN.

4 KARAOKE MODE

ON OFF



Press KARAOKE MODE to ON .

5

Play the tape, or the CD player connected to CD/TV LINE IN.

6

1 MIC VOL 2



ECHO VOL



Adjust the microphone volume and echo level.

Tips

- To record KARAOKE sounds using KARAOKE tapes as the sound source;
 - 1 Set FUNCTION to DUBBING.
 - 2 Insert a KARAOKE tape in deck A and a recording tape in deck B.
 - 3 Press KARAOKE MODE to ON .
 - 4 Follow steps 4 and 5 in page 11.
- To record KARAOKE sounds using KARAOKE CDs as the sound source;
 - 1 Set FUNCTION to CD/TV LINE IN.
 - 2 Insert a recording tape in deck B.
 - 3 Press KARAOKE MODE to ON .
 - 4 Press ●REC on deck B and then play the CD.

When using the KARAOKE MODE

Set to ON so that the accompaniment recorded on the left channel only is output to both speakers.

Set to OFF to turn off the KARAOKE so that the accompaniment recorded on the left channel is output to the left speaker and the vocal on the right channel is output to the right speaker.

When the KARAOKE is not used

Make sure that the KARAOKE MODE is set to OFF and disconnect the microphones from the MIX MIC jack.

When recording a stereo sound

Set the KARAOKE to OFF to avoid monaural recording. The output from the right channel will not be recorded when the KARAOKE is set to ON .

Finding the beginning of a track (AMS*)

The player senses where a track begins by detecting the pauses between the tracks (deck B only).

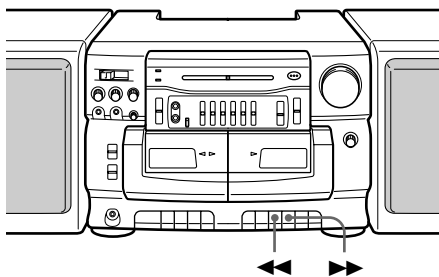

*Automatic Music Sensor

- 1 While playing a tape, press ►► or ◀◀.

Playing side	The beginning of the next track	The beginning of the current track
Front side (►)	►►	◀◀
Reverse side (◀)	◀◀	►►

The tape is wound or rewound to the beginning of the next or current track, and play will start automatically.

Notes

- If a soft sound like pianissimo continues for some seconds in a track, the player may start to play as the next track.
- If you press ►► or ◀◀ when there is no sound in the track, this function does not operate correctly.
- To find the beginning of a track correctly, a pause of approx. 4 seconds or longer is necessary.

Playing both decks in succession

You can play both decks (from deck B to deck A only) in succession.

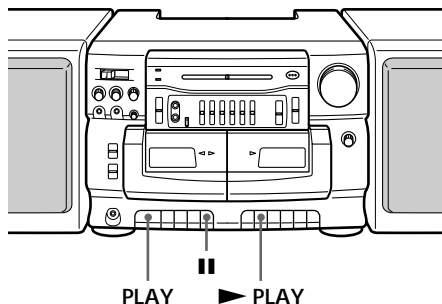

- 1 Insert the cassette you want to play first into deck B and the other cassette into deck A.
- 2 Press ► PLAY on deck B and then press PLAY and || on deck A at the same time.

When the tape ends on deck B, the playback starts automatically on deck A.

Hooking up the system

Make sure to turn off the power before making any connections.

Tip

- To detach the speakers, unlock the speaker **b** and slide the speaker box all the way up and away from the player.
- Connect only the supplied speakers for this unit to the speaker terminals of this unit. If you connect any other speakers or equipment to the speaker terminal, malfunction may occur.

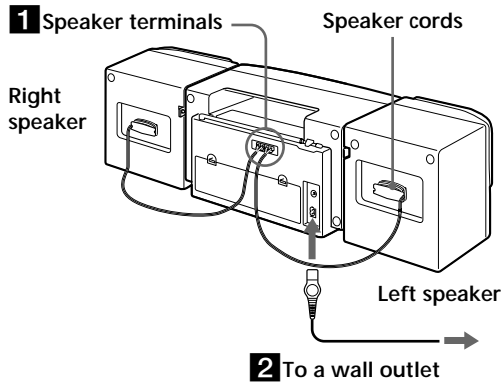

1 Hooking up the Speakers

1 Align the grooves and slide the speaker box down until it snaps into place **a**.

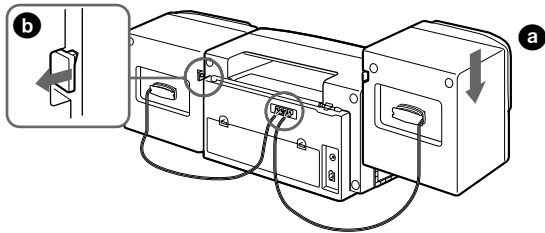

2 Connect the black wires to (-) minus and the red wires to (+) plus terminals: the right speaker wires to the R (right), and the left speaker wires to the L (left) terminals.

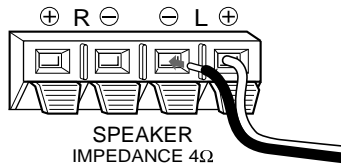

Tip

For customers supplied with an AC plug adaptor, use it if the plug of the AC power cord (mains lead) does not match your wall outlet (mains).

Note

- Replace the batteries when the OPR/BATT indicator dims or when the player stops operating. Replace all batteries with new ones.

2 Connecting the AC power cord

Connect the supplied AC power cord to the AC IN jack.

Adjusting the voltage

Be sure to set the VOLTAGE SELECTOR (at the rear) to your local power supply.

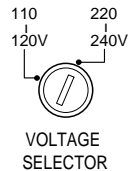

3 Using the player on batteries

Insert eight R20 (size D) batteries (not supplied) into the battery compartment.

To use the player on batteries, disconnect the AC power cord from the player.

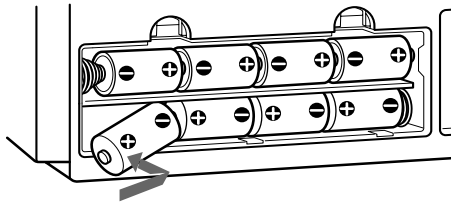

Connecting optional components

Before making connections, be sure to turn off the power of the component and set FUNCTION to TAPE/RADIO OFF on the player.

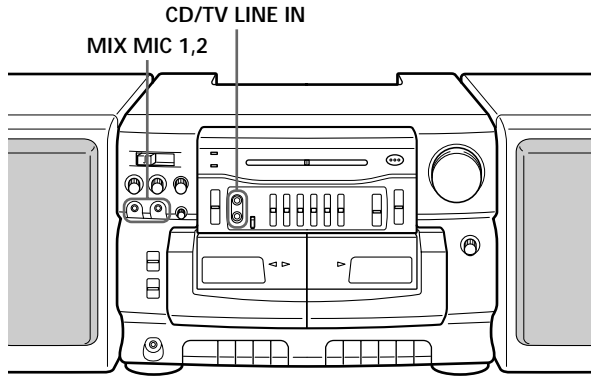

Tip

You can record the sound of the connected component. Insert a cassette, and press ● REC on deck B.

Note

Connect the cables firmly to avoid any malfunction.

Tips

- To mix radio or tape sounds and your voice, play the sound you want, and speak or sing into the microphone.
- To use the player as a public address system, set FUNCTION to CD/TV LINE IN, and speak into the microphone.

Note

If acoustic feedback (howling) occurs, turn down the volume or move the microphone away from the speakers.

Listening to Audio Components

You can enjoy the sound from a TV or a CD player through the speakers of this player.

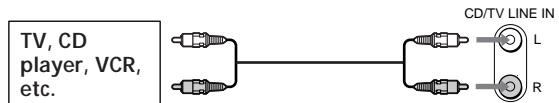

After connecting the component, set FUNCTION to CD/TV LINE IN and play the connected component.

Using the Microphone

Plug the microphone (supplied) into the MIX MIC jack and turn on the microphone.

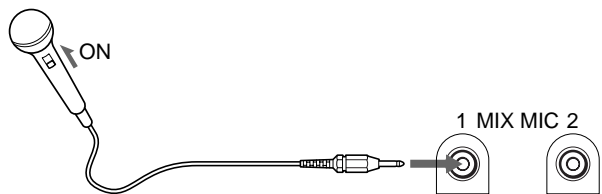

Adjusting the audio emphasis (DYNAMIC SOUND SYSTEM)

You can adjust the sound by selecting one of the three PRESET MODES, or by using the 5 BAND GRAPHIC EQUALIZER.

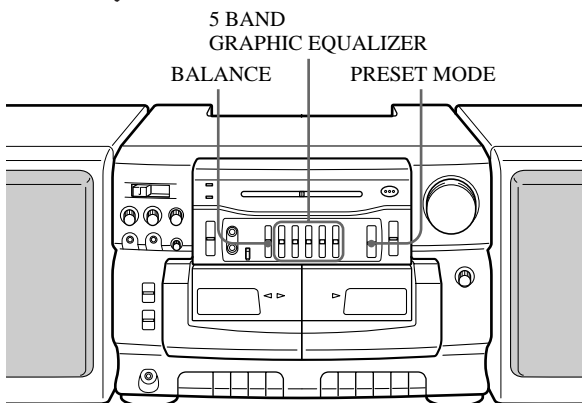

Using the PRESET MODE

Use	To
MANUAL	Adjust the sound using the 5 BAND GRAPHIC EQUALIZER.
DISCO	Get powerful, clear sounds emphasizing low and high range audio.
PARTY	Get light, bright sounds emphasizing high and middle range audio.
LIVE	Get wide-ranging sounds having presence.

Using the 5 BAND GRAPHIC EQUALIZER

Use	To adjust
BALANCE	Stereo imaging.
MEGA BASS	Deep bass sound.
400 Hz	Speaking voice, middle frequencies of instrumental music.
1 kHz	Presence of vocals
4 kHz	Brightness of the sound.
10 kHz	High treble sounds or to reduce high frequency noise/tape hiss.

Note

When using the 5 BAND GRAPHIC EQUALIZER, be sure to set PRESET MODE to MANUAL. The graphic equalizer will not work in any other position.

Precautions

On safety

Should any solid object or liquid fall into the player, unplug the player and have it checked by qualified personnel before operating it any further.

On power sources

- For AC operation, check that the player's operating voltage is identical with your local power supply (see "Specifications") and use the supplied AC power cord; do not use any other type. The voltage selector is located at the rear of the player.
- The player is not disconnected from the AC power source (mains) as long as it is connected to the mains, even if the player itself has been turned off.
- For battery operation, use eight R20 (size D) batteries.
- When the batteries are not to be used, remove them to avoid damage that can be caused by battery leakage or corrosion.
- The nameplate indicating operating voltage, power consumption, etc. is located at the rear.

On placement

- Do not leave the player in a location near heat sources, or in a place subject to direct sunlight, excessive dust or mechanical shock.
- Do not place anything within 10 mm of the side of the cabinet. The ventilation holes must be unobstructed for the player to operate properly and to prolong the life of its components.

- Since a strong magnet is used for the speakers, keep personal credit cards using magnetic coding or spring-wound watches away from the player to prevent possible damage from the magnet.

On operation

If the player has not been used for a long time, set it in the playback mode to warm it up for a few minutes before inserting a cassette.

If you have any questions or problems concerning your player, please consult your nearest Sony dealer.

Notes on cassettes

- Break off the cassette tab from side A or B to prevent accidental recording.

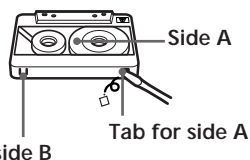

- To record on a tape with its tab broken off, cover the respective tab hole for side A or B with adhesive tape.
- The use of a cassette with more than 90 minutes of play time is not recommended except for long, continuous recording or playback.

Troubleshooting

	Symptom	Remedy
General	There is no audio.	<ul style="list-style-type: none">• Connect the AC power cord securely.• Insert the batteries properly.• Replace all batteries if they are weak.• Unplug the headphones.• Adjust the volume.• Set FUNCTION to the position you want to operate.
	Cassette cannot be inserted.	<ul style="list-style-type: none">• Insert the cassette properly.
Tape Player	The ●REC button does not function.	<ul style="list-style-type: none">• No cassette is in deck B.• Make sure the safety tab on the cassette is in place.
	Poor playback, recording or erasing quality.	<ul style="list-style-type: none">• Dirty heads. Clean the unit with a cotton swab slightly moistened with cleaning fluid or alcohol (see page 21).• Demagnetize the heads and all metallic parts in the tape path with a commercially available tape head demagnetizer.

Maintenance

Cleaning the tape heads and tape path

Wipe the heads, the pinch roller and the capstan with a cleaning swab slightly moistened with cleaning fluid or alcohol after every 10 hours of operation for optimum playback and recording quality. To make the best possible recording, however, we recommend that you clean all surfaces over which tape travels before each recording. After cleaning, insert a tape when the areas cleaned are completely dry.

Demagnetizing the tape heads

After 20 to 30 hours of use, enough residual magnetism will have built up on the tape heads to begin to cause loss of high frequency sound and hiss. At this time, you should demagnetize the heads and all metal parts in the tape path with a commercially available tape head demagnetizer.

Cleaning the cabinet

Clean the cabinet, panel and controls with a soft cloth slightly moistened with a mild detergent solution. Do not use any type of abrasive pad, scouring powder, or solvent, such as alcohol or benzine.

Deck A

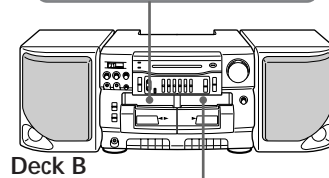
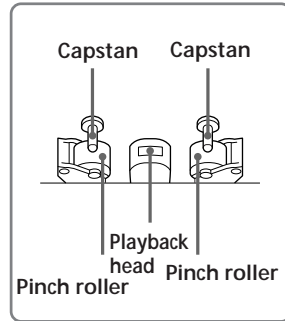

Deck B

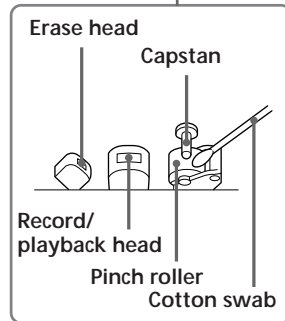

Specifications

Radio section

Frequency range

FM: 87.6–108MHz
MW: 530–1,605kHz
SW1: 2.3–7MHz
SW2: 7–22MHz

IF FM: 10.7MHz MW/SW: 455kHz

Aerials

FM/SW: Telescopic
MW: Built-in ferrite bar

Cassette-corder section

Recording system

4-track, 2-channel stereo

Frequency response

80–12,500Hz

General

Speakers

Full range: 10cm (4 inches) dia., cone type
Tweeter: 5cm (2 inches) dia.

Input

MIX MIC jacks (minijack), sensitivity 3.9 mV for low impedance microphone
CD/TV LINE IN jacks (phone jacks), sensitivity 0.43 V, input impedance 50 kilohms

Output

Headphones jack (stereo minijack), for 16–68 ohms impedance headphones

Maximum Power output

12W + 12W

Battery life

FM Recording: Sony R20P: Approx. 4 hours/Sony LR20 alkaline: Approx. 12 hours
Playback: Sony R20P: Approx. 3 hours/Sony LR20 alkaline: Approx. 6 hours

Power requirements

110–120V/220–240 V AC selectable, 50/60Hz
12V DC, eight R20 (size D) batteries

Power consumption

AC 30W

Dimensions

Approx. 760 x 225 x 220mm (w/h/d) (30 x 8 ⁷/₈ x 8 ³/₄ inches) incl. projecting parts and controls, not incl. handle

Mass

Approx. 8.5kg (18 lb 12 oz) incl. batteries

Supplied accessory

AC power cord (1)
Microphone (1)

Design and specifications are subject to change without notice.

Index

A

AMS 14

Audio emphasis 18

B

Batteries

for player 16

C

Cleaning

cabinet 21

tape heads and path 21

D, E

Demagnetizing tape heads
21

Dubbing 10

at high speed 10

F, G

FINE TUNING 4

FIVE BAND GRAPHIC
EQUALIZER 18

H, I, J

HIGH SPEED DUBBING
10

Hooking up

AC power source 16

speakers 15

K, L

KARAOKE 12

M, N

Microphone 12, 17

built-in 8

O

Optional components

connecting 17

P, Q

PRESET MODE 18

Public address system

using the player as 17

R, S

Radio

listening to 4

improving reception 5

Recording 8

T, U

Tape

direction of the 7

dubbing a 10

playing a 6

playing both decks in
succession 14

recording on a 8

Troubleshooting 20

V, W, X, Y, Z

Voltage selector 16

