

# *Integrated AV Amplifier*

---

Operating Instructions

Read this book first

*TA-AV571*

## WARNING

To prevent fire or shock hazard, do not expose the unit to rain or moisture.

### CAUTION

TO PREVENT ELECTRIC SHOCK, DO NOT USE THIS POLARIZED AC PLUG WITH AN EXTENSION CORD, RECEPTACLE OR OTHER OUTLET UNLESS THE BLADES CAN BE FULLY INSERTED TO PREVENT BLADE EXPOSURE.

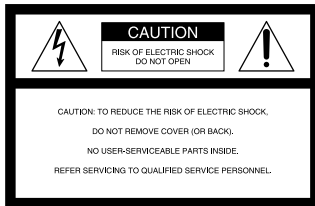

This symbol is intended to alert the user to the presence of uninsulated "dangerous voltage" within the product's enclosure that may be of sufficient magnitude to constitute a risk of electric shock to persons.



This symbol is intended to alert the user to the presence of important operating and maintenance (servicing) instructions in the literature accompanying the appliance.

This Class B digital apparatus meets all requirements of the Canadian Interference Causing Equipment Regulations.

### Owner's record

The model and serial numbers are located on the rear of the unit. Record the serial number in the space provided below. Refer to them whenever you call upon your Sony dealer regarding this product.

Model No. TA-AV571

Serial No. \_\_\_\_\_

## INFORMATION

This equipment has been tested and found to comply with the limits for a Class B digital device, pursuant to Part 15 of the FCC Rules. These limits are designed to provide reasonable protection against harmful interference in a residential installation. This equipment generates, uses, and can radiate radio frequency energy and, if not installed and used in accordance with the instructions, may cause harmful interference to radio communications. However, there is no guarantee that interference will not occur in a particular installation. If this equipment does cause harmful interference to radio or television reception, which can be determined by turning the equipment off and on, the user is encouraged to try to correct the interference by one or more of the following measures:

- Reorient or relocate the receiving antenna.
- Increase the separation between the equipment and receiver.
- Connect the equipment into an outlet on a circuit different from that to which the receiver is connected.
- Consult the dealer or an experienced radio/TV technician for help.

### CAUTION

You are cautioned that any changes or modification not expressly approved in this manual could void your authority to operate this equipment.

## Precautions

### On safety

Should any solid object or liquid fall into the cabinet, unplug the amplifier and have it checked by qualified personnel before operating it any further.

### On power sources

- Before operating the amplifier, check that the operating voltage is identical with your local power supply. The operating voltage is indicated on the nameplate at the rear of the amplifier.
- If you are not going to use the amplifier for a long time, be sure to disconnect the amplifier from the wall outlet. To disconnect the AC power cord, grasp the plug itself; never pull the cord.
- One blade of the plug is wider than the other for the purpose of safety and will fit into the wall outlet only one way. If you are unable to insert the plug fully into the outlet, contact your dealer.
- Should the AC power cord need to be changed, have it done at a qualified service shop only.

### On placement

- Place the amplifier in a location with adequate ventilation to prevent heat build-up and prolong the life of the amplifier.
- Do not place the amplifier near heat sources, or in a place subject to direct sunlight, excessive dust or mechanical shock.
- Do not place anything on top of the cabinet that might block the ventilation holes and cause malfunctions.

### On operation

Before connecting other components, be sure to turn off and unplug the amplifier.

### On cleaning

Clean the cabinet, panel and controls with a soft cloth slightly moistened with a mild detergent solution. Do not use any type of abrasive pad, scouring powder or solvent such as alcohol or benzene.

If you have any question or problem concerning your amplifier, please consult your nearest Sony dealer.

## About This Manual

### Conventions

- The instructions in this manual describe the controls on the amplifier. You can also use the controls on the remote if they have the same or similar names as those on the amplifier.
- A “Quick Reference Guide” is supplied on the back cover.
- The “Remote Button Descriptions” section on page 19 provides an overview of the remote buttons.
- The following icons are used in this manual:



Indicates that you can use only the remote to do the task.



Indicates hints and tips for making the task easier.

This amplifier incorporates the Dolby Pro Logic Surround system. Manufactured under license from Dolby Laboratories Licensing Corporation. “Dolby,” the double-D symbol  and “Pro Logic” are trademarks of Dolby Laboratories Licensing Corporation.

# TABLE OF CONTENTS

---

## Getting Started

Unpacking .....	4
Hookup Overview .....	4
Audio/Video Component Hookups .....	5
Speaker System Hookups .....	6
AC Hookups .....	7

---

## Amplifier Operations

Selecting a Component .....	8
Recording .....	9

---

## Using Sound Fields

Choosing a Surround Mode .....	10
Getting the Most Out of Dolby Pro Logic Surround Sound .....	11
Using Preset Sound Fields .....	13

---

## Additional Information

Troubleshooting .....	14
Specifications .....	15
Glossary .....	16

---

## Index .....

---

## Rear Panel Descriptions .....

---

## Remote Button Descriptions .....

---

## Quick Reference Guide .....

back cover

## Unpacking

Check that you received the following items with the amplifier:

- Remote controller (remote) (1)
- Size AA (R6) batteries (2)

## Inserting batteries into the remote

Insert two size AA (R6) batteries in accordance with the + and - marking on the battery compartment. When using the remote, point it at the remote sensor  on the amplifier.

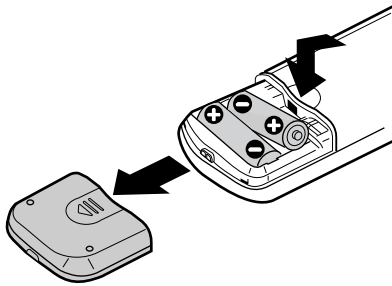

### When to replace batteries

Under normal use, the batteries should last for about 6 months. When the remote no longer operates the amplifier, replace both batteries with new ones.

### Notes

- Do not leave the remote in an extremely hot or humid place.
- Do not use a new battery with an old one.
- Do not expose the remote sensor to direct sunlight or lighting apparatuses. Doing so may cause a malfunction.
- If you don't use the remote for an extended period of time, remove the batteries to avoid possible damage from battery leakage and corrosion.

## Hookup Overview

The amplifier allows you to connect and control the following audio/video components. Follow the hookup procedures on the specified pages for the components that you want to connect to the amplifier. To learn the locations and names of each jacks, see "Rear Panel Descriptions" on page 18.

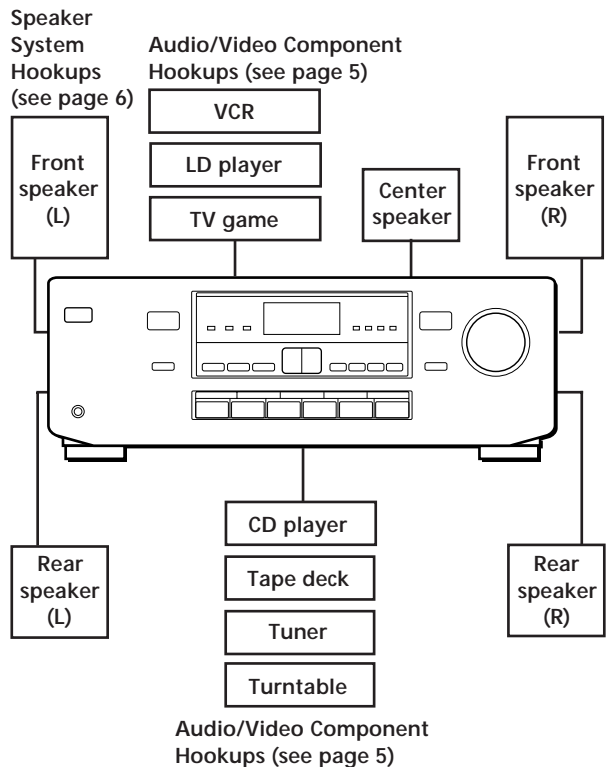

## Before you get started

- Turn off the power to all components before making any connections.
- Do not connect the AC power cords until all of the connections are completed.
- Be sure to make connections firmly to avoid hum and noise.
- When connecting an audio cable, be sure to match the color-coded pins to the appropriate jacks on the components: White (left, audio) to White; and Red (right, audio) to Red.

# Audio/Video Component Hookups

## Overview

This section describes how to connect your audio and video (audio signal only) components to the amplifier, so you can listen to stereo sources in surround sound. For specific locations of the jacks, see the illustration below.

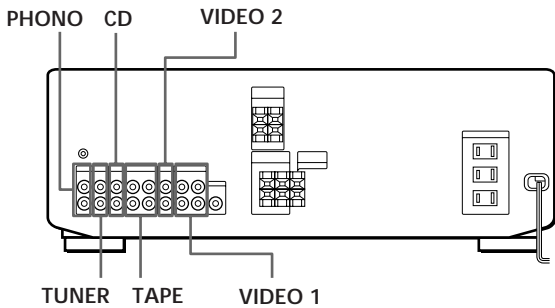

### What cords will I need?

Audio cords (1 for the CD player, tuner, turntable, LD player or TV game; 2 for the tape deck or VCR)

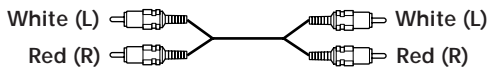

## Hookups

The arrow  $\Rightarrow$  indicates signal flow.

### CD player

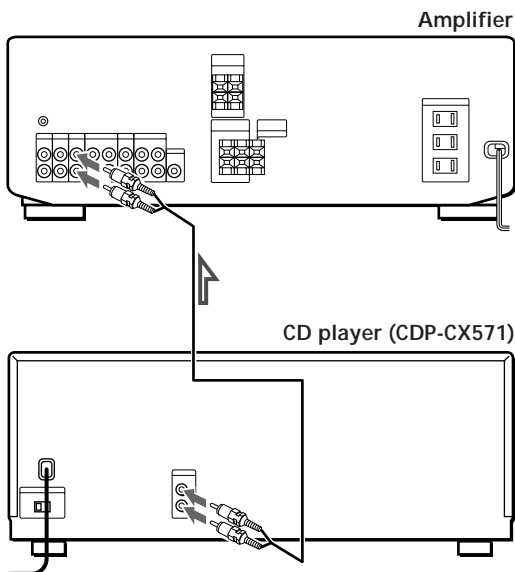

### Tuner

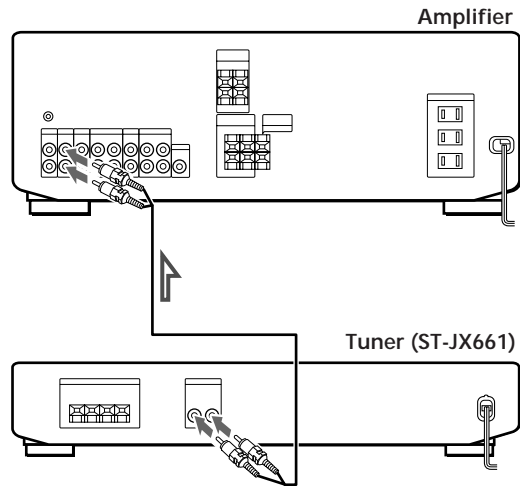

### Tape deck

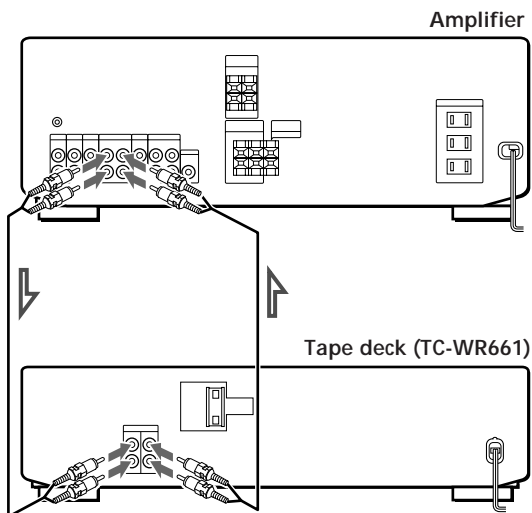

### Turntable

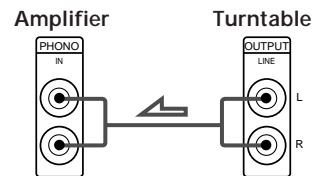

- If your turntable has an earth lead To prevent hum, connect the earth lead to the  $\perp$  ground terminal on the amplifier.

(continued)

VCR

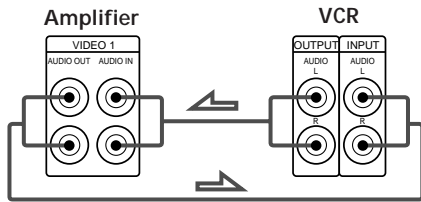

LD player/TV game

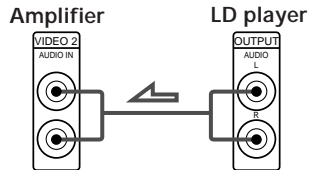

## Where do I go next?

Go on to the next section to connect the speakers.

## Speaker System Hookups

### Overview

This section describes how to connect your speakers to the amplifier. Front (left and right) speakers are required but center and rear speakers are optional. The center and rear speakers enhance the surround effects. Connecting the active woofer will increase bass response.

For specific locations of the terminals, see the illustration below.

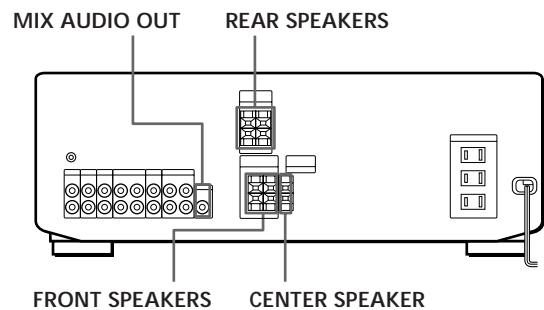

For optimum surround sound effect, place your speakers as shown below.

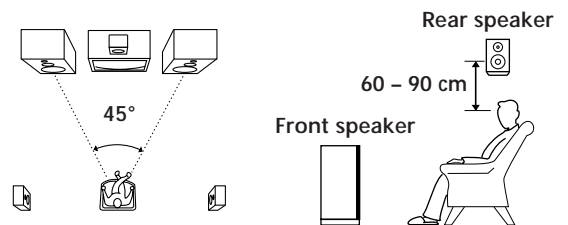

### What cords will I need?

Speaker cord (1 for each speaker)



Twist the stripped ends of the cord about 2/3 inch (15 mm). Be sure to match the speaker cord to the appropriate terminal on the components: + to + and - to -. If the cords are reversed, the sound will be distorted and will lack bass.

## Hookups

### Front speakers

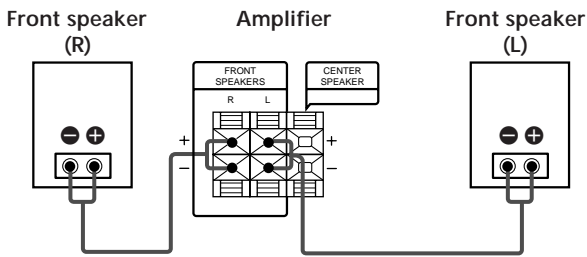

### Rear and center speakers

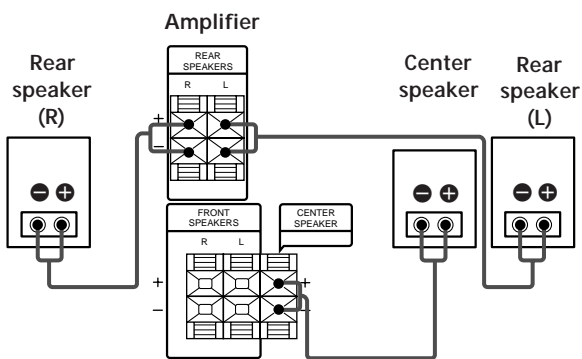

### Active woofer

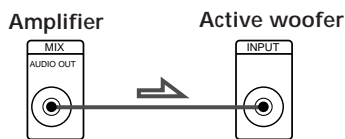

## Where do I go next?

Go on to the next section to connect the AC power cord and complete your home theater system.

## AC Hookups

### Connecting the AC power cord

Connect the AC power cord from this amplifier and from your audio/video components to wall outlets. If you connect other audio components to the SWITCHED AC OUTLETS on the amplifier, the amplifier can supply power to the connected components so you can turn on/off whole system when you turn on/off the amplifier.

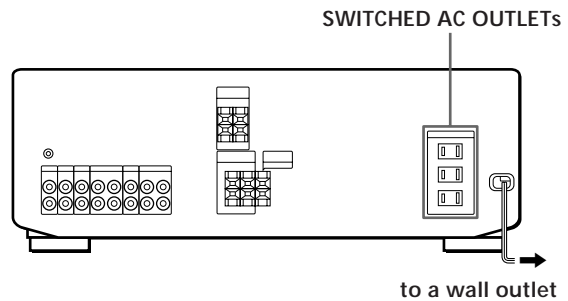

### Caution

Make sure that the power consumption of the components connected to the amplifier's AC outlet does not exceed 120 watts. Do not connect high-wattage electrical home appliances such as electric irons, fans, or TVs to this outlet.

## Selecting a Component

To listen to a connected component, first select the function on the amplifier or with the remote.

- Before you begin, make sure you have connected all components securely and correctly as indicated on pages 5 to 7.
- Be sure to turn the MASTER VOLUME all the way down before turning off the amplifier to avoid damaging your speakers the next time you turn it on.

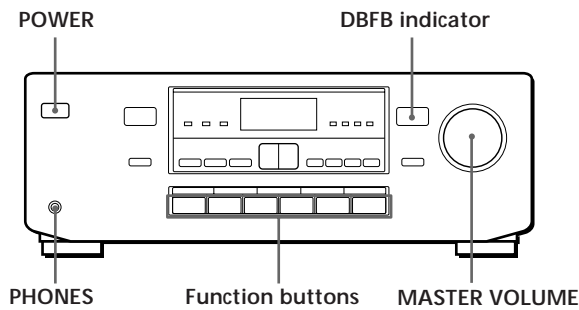

**1** Press POWER to turn on the amplifier.

**2** Press one of the function buttons to select the component you want to use:

To listen	Press
Records	PHONO
Radio programs	TUNER
Compact discs (CD)	CD
Audio tapes	TAPE
Video tapes	VIDEO 1
Laser discs (or TV game)	VIDEO 2

**3** Turn on the component, for example, a CD player, and then start playing.

**4** Turn MASTER VOLUME to adjust the volume.

To	Do this
Adjust the bass	Press BASS and then press + or -.
Adjust the treble	Press TREBLE and then press + or -.
Emphasize the bass*	Press DBFB ON/OFF. (The indicator lights up when the DBFB is ON.)

\* You cannot use the DBFB when you select PHONO.

**💡** When you listen with headphones  
Connect the headphones to the PHONES jack.  
No sound is heard from your speakers.



## Using the remote

The remote lets you operate the amplifier and the Sony components that are connected to it.

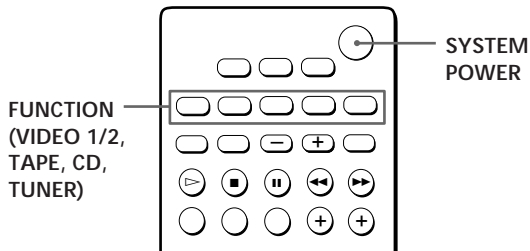

- 1 Press SYSTEM POWER to turn on the amplifier.
- 2 Press one of the FUNCTION buttons to select the component you want to use:

To listen to	Press
Radio programs	TUNER
Audio tapes	TAPE
Compact discs (CD)	CD
Video tapes	VIDEO1
Laser discs (or TV game)	VIDEO2

If the component does not turn on  
Press the power switch on the component.

- 3 Start playing.  
See "Remote Button Descriptions" on page 19 for details.

### To turn off the components

Press SYSTEM POWER. You can turn off audio components connected to the SWITCHED AC OUTLETS on the back of the amplifier at the same time.

## Recording

This amplifier makes it easy to record to and from the components connected to the amplifier. You don't have to connect playback and recording components directly: once you select a program source on the amplifier, you can record and edit as you normally would using the controls on each component.

Before you begin, make sure you've connected all components properly.

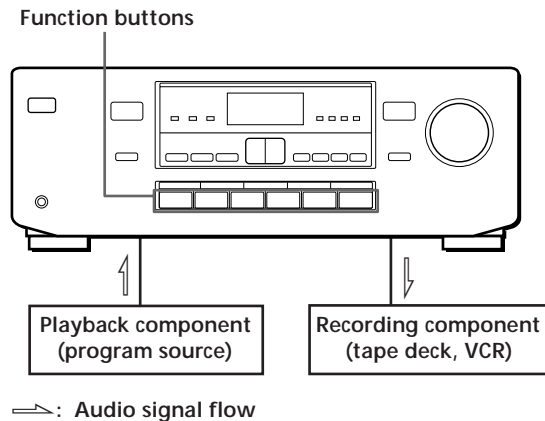

## Recording on an audio tape or video tape

You can record on an audio tape or video tape using the amplifier. Refer to the instruction manual for the tape deck or VCR if you need help.

- 1 Press one of the function buttons to select the component to be recorded.
- 2 Set the component to be ready for playing.  
For example, insert a CD into the CD player.
- 3 Insert a blank tape into the recording deck and adjust the recording level, if necessary.
- 4 Start recording on the recording deck and then start playing the component.

## Choosing a Surround Mode

You can take advantage of surround sound simply by selecting one of the three pre-programmed surround modes according to the type of program you wish to play.

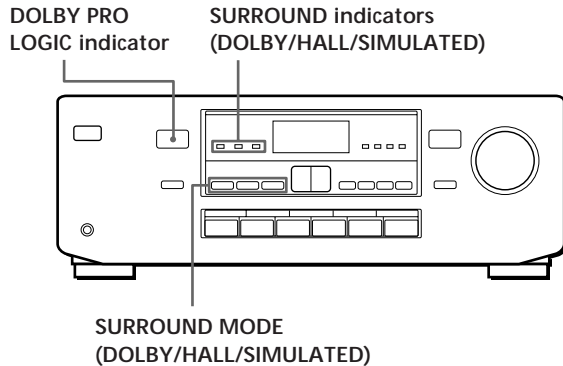

- 1 Press one of the SURROUND MODE buttons (DOLBY, HALL or SIMULATED) to turn on the surround sound. Selected mode's indicator lights up. The DOLBY PRO LOGIC indicator lights up when you select DOLBY. Select the appropriate surround mode as follows:

For tapes/discs with	Select	To
Dolby Pro Logic Surround	DOLBY	Decode programs processed with Dolby Surround and create the atmosphere of a movie theater.
Orchestral music, chamber music, or an instrumental solo	HALL	Reproduce the acoustics of a rectangular concert hall. Ideal for soft, acoustic sounds.
Monaural recording, such as an old movie or an instrumental	SIMULATED	Reproduce a simulated stereo effect to monaural sound.

**To turn off surround sound**  
Press SURROUND MODE (DOLBY, HALL or SIMULATED) you selected in Step 1.

When you use the remote The remote also lets you choose the surround mode.

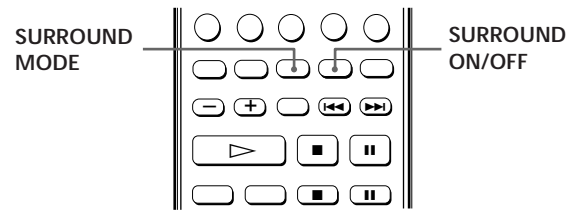

- 1 Press SURROUND MODE repeatedly until the surround mode you wish to is displayed. Each time SURROUND MODE is pressed, the display changes as follows:

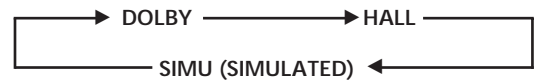

**To turn off surround sound**  
Press SURROUND ON/OFF.

You can find Dolby Surround-encoded software by looking at the packaging. However, some videos and laser discs may use Dolby Surround sound even if it's not indicated on the package.

## Getting the Most Out of Dolby Pro Logic Surround Sound

To obtain the best possible Dolby Pro Logic Surround sound, first select the center mode. Then, adjust the volume of each speaker.

Note that you must connect the rear speakers and/or a center speaker to do the following adjustments.

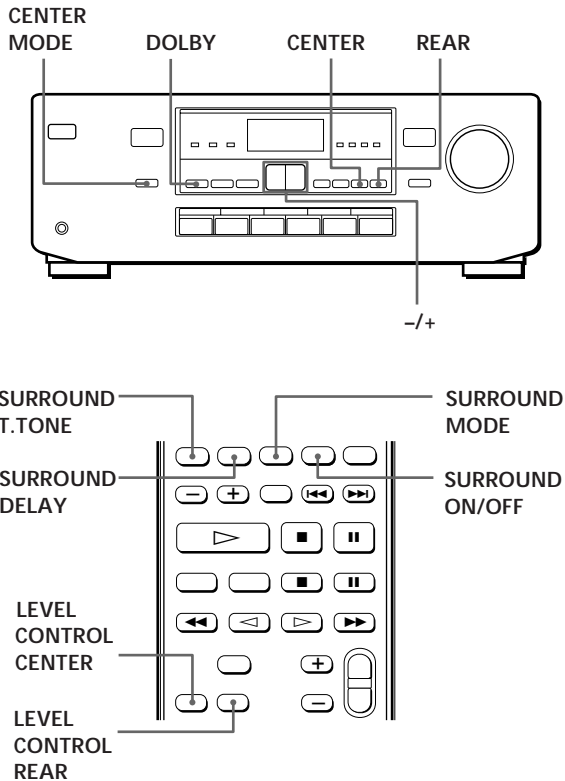

### Selecting the center mode

The amplifier offers you four center modes: NORMAL, WIDE, 3 CH, and PHANTOM. Each mode is designed for a different speaker configuration. Select the mode that best suits your speaker's system configuration.

- 1 Press DOLBY to turn on the Dolby Pro Logic mode.
- 2 Press CENTER MODE repeatedly until the center mode you want appears in the display. Select the center mode by referring to the following chart.

If you have	Select	So that
Front and rear speakers, and a small center speaker	NORMAL	The bass sound of the center channel is output from the front speakers (because a small speaker cannot produce enough bass).
Front and rear speakers, and a large center speaker	WIDE	For wide range Dolby Pro Logic Surround sound to all speakers.
Front and center speakers, no rear speaker	3 CH (3 Channel Logic)	The sound of the rear channel is output from the front speakers.
Front and rear speakers, no center speaker	PHANTOM	The sound of the center channel is output from the front speakers.

When you use the remote , Press SURROUND MODE repeatedly to select DOLBY. You can adjust the speaker's volume or delay time simply by pressing the buttons on the remote.

(continued)

### Adjusting the speaker volume

The test tone feature lets you set the volume of your speakers to the same level. (If all of your speakers have equal performance, you don't have to adjust the speaker volume.)

Using the controls on the remote lets you adjust the volume level from your listening position.

- 1 Press SURROUND T.TONE.  
You will hear the test tone from each speaker sequentially.
- 2 Adjust the volume level so that the test tone from each speaker is at the same level from your listening position.
  - To adjust the level of center speaker, press LEVEL CONTROL CENTER and then + or -.
  - To adjust the level of rear speakers, press LEVEL CONTROL REAR and then + or -.
- 3 Press SURROUND T.TONE to turn off the test tone.

 You can also adjust the center or rear speakers using the controls on the amplifier

- 1 Press DOLBY to turn on the Dolby Pro Logic mode.  
The DOLBY PRO LOGIC indicator lights up.
- 2 Press CENTER or REAR. The CENTER or REAR indicator lights up.
- 3 Press + or - to adjust the level.

#### Notes

- The center and rear levels are indicated on the level meter in the display during adjustment.
- The center and rear levels are adjustable in the following situations.
  - Center level: when the Dolby Pro Logic is on (when the DOLBY PRO LOGIC indicator is lit)
  - Rear level: when the SURROUND MODE (DOLBY, HALL or SIMULATED) is on

 You can adjust all speakers at one time  
Adjust MASTER VOLUME on the amplifier.

### Adjusting the delay time

You can make the surround sound more effective by delaying the output from the rear speakers (delay time). You can adjust the delay time as follows.

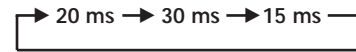

For example, if you've placed the rear speakers in a large room or apart from your listening position, set the delay time shorter.

- 1 Start playing a program source encoded with Dolby Surround sound.
- 2 Press SURROUND DELAY repeatedly to adjust the delay time.

## Using Preset Sound Fields

You can take advantage of sound fields simply by selecting one of the five pre-programmed ones according to the program you want to play.

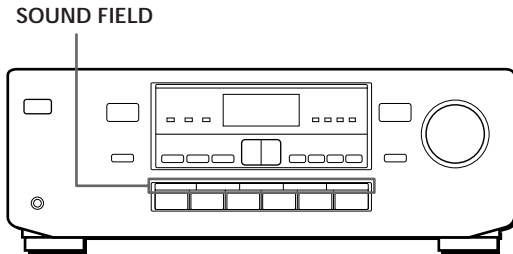

- 1 Press one of the SOUND FIELD buttons so that the sound field you wish to is displayed.  
Select the appropriate sound field as follows:

Press	To reproduce
1 ROCK	Powerful, clear sounds, emphasizing low and high range audio.
2 POPS	Light, bright sounds, emphasizing high and middle range audio.
3 CLASSIC	Broad, open sounds with plenty of reverberation using a surround effect.
4 MOVIE	A theater-like environment using a surround effect.
5 GAME	Maximum audio impact from video game software using a surround effect.

### To turn off the sound fields

Press SOUND FIELD you selected in Step 1.  
“OFF” appears in the display, and the sound field’s effect is turned off.

#### When you use the remote

Press SOUND FIELD.

Each time this button is pressed, the display changes as follows:

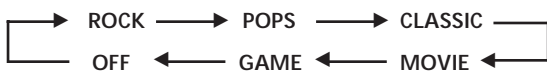

#### When you want to listen to CLASSIC, MOVIE or GAME without a surround effect

Press one of the SURROUND MODE buttons to turn off the respective indicator.

## Troubleshooting

If you experience any of the following difficulties while using the amplifier, use this troubleshooting guide to help you remedy the problem. Should any problem persist, consult your nearest Sony dealer.

There's no sound or only a very low-level sound is heard.

- ➔ Check that the speakers and components are connected securely.
- ➔ Make sure you select the correct component on the amplifier.
- ➔ Make sure you select the correct component on the amplifier for the front speakers.
- ➔ The protective device on the amplifier has been activated because of a short-circuit. ("PROTECT" flashes.) Turn off the amplifier to eliminate the short-circuit problem and turn on the power again.

The left and right sounds are unbalanced or reversed.

- ➔ Check that the speakers and components are connected correctly and securely.

Severe hum or noise is heard.

- ➔ Check that the speakers and components are connected securely.
- ➔ Check that the connecting cords are away from a transformer or motor, and at least 10 feet (3 meters) away from a TV set or fluorescent light.
- ➔ Place your TV away from the audio components.
- ➔ The plugs and jacks are dirty. Wipe them with a cloth slightly moistened with alcohol.

No sound is heard from the center speaker.

- ➔ Select the DOLBY Surround mode (see page 10).
- ➔ Select the appropriate center mode (see page 11).
- ➔ Adjust the speaker volume appropriately (see page 12).

No sound or only a very low-level sound is heard from the rear speakers.

- ➔ Make sure you turned on the surround mode or sound field function.
- ➔ Select the appropriate center mode (see page 11).
- ➔ Adjust the speaker volume appropriately (see page 12).

Surround effect cannot be obtained.

- ➔ Turn on the surround mode or sound field function.

No sound, or only a very low-level sound is heard when adjusting the test tone.

- ➔ Turn MASTER VOLUME clockwise.

Recording cannot be made.

- ➔ Check that the components are connected correctly.
- ➔ Select the source component with the function buttons.

The remote does not function.

- ➔ Point the remote at the remote sensor  on the amplifier.
- ➔ Remove the obstacles in the path of the remote and the amplifier.
- ➔ Replace both batteries in the remote with new ones if they are weak.
- ➔ Make sure you select the correct function on the remote.

## Specifications

### Audio power specifications

### POWER OUTPUT AND TOTAL HARMONIC DISTORTION:

With 8 ohm loads both channels driven, from 70 - 20,000 Hz; rated 100 watts per channel minimum RMS power, with no more than 0.9 % total harmonic distortion from 250 milliwatts to rated output.

### Amplifier section

Surround mode (8 ohms at 1 kHz, THD 0.9%)  
 front: 100 W/ch  
 center: 100 W (only in the PRO LOGIC mode)  
 rear: 100 W

### Inputs

	Sensitivity	Impedance
PHONO	2.5 mV	50 kilohms
CD	400 mV	50 kilohms
TAPE, VIDEO 1, 2, TUNER	250 mV	50 kilohms

Outputs  
 TAPE, VIDEO 1:  
 Voltage 250 mV,  
 Impedance 1 kilohms  
 HEADPHONES:  
 Accepts low and high impedance headphones

TONE ±10 dB at 100 Hz and 10 kHz

### General

Power requirements	120 V AC, 60 Hz
Power consumption	U.S.A. model: 190 W Canadian model: 290 VA
AC outlets	3 switched, total 120 W
Dimensions	430 x 160 x 355 mm (16 <sup>15</sup> / <sub>16</sub> x 6 <sup>3</sup> / <sub>16</sub> x 14 inches)
Mass (Approx.)	8.2 kg (18 lb 2 oz)
Supplied accessories	Remote controller (remote) (1) Size AA (R6) batteries (2)

Design and specifications are subject to change without notice.

# Glossary

## Center mode

Setting of speakers to enhance Dolby Pro Logic Surround mode. To obtain the best possible surround sound, select one of the following four center modes according to your speaker system.

- **NORMAL mode**

Select NORMAL mode if you have front and rear speakers and a small center speaker. Since a small speaker cannot produce enough bass, the bass sound of the center channel is output from the front speakers.

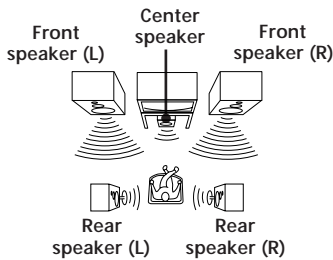

- **WIDE mode**

Select WIDE mode if you have front and rear speakers and a large center speaker. With the WIDE mode, you can take full advantage of Dolby Surround sound.

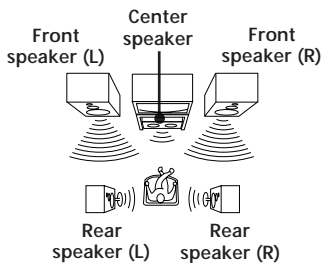

- **3 CH mode**

Select 3 CH mode if you have front and center speakers but no rear speaker. The sound of the rear channel is output from the front speakers to let you experience some of the surround sound without using rear speakers.

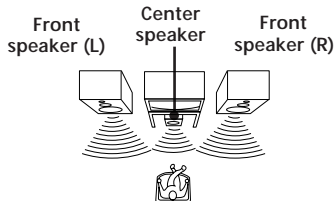

- **PHANTOM mode**

Select PHANTOM mode if you have front and rear speakers but no center speaker. The sound of the center channel is output from the front speakers.

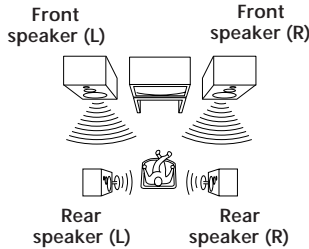

## Delay time

Time lag between the surround sound output from front speakers and rear speakers. By adjusting the delay time of the rear speakers, you can obtain the feeling of presence. Make the delay time longer when you have placed the rear speakers in a small room or close to your listening position, and make it shorter when you have placed them in a large room or apart from your listening position.

## Dolby Pro Logic Surround

Decoding system of Dolby Surround sound standardized in TV programs and movies. Compared with the former Dolby Surround system, Dolby Pro Logic Surround improves sound image by using four separate channels: off-screen audio effects, on-screen dialog, left-to-right panning, and music. These channels manipulate the sound to be heard and enhance the action as it happens on the screen. To take advantage of Dolby Pro Logic, you should have at least one pair of rear speakers and/or one center speaker. You also need to select the appropriate center mode to enjoy a full effect.

## Dolby Surround

Encoding and decoding system of Dolby Surround sound for consumer use. Dolby Surround decodes the extra channels on the Dolby Surround-encoded sound tracks of movie videos and TV programs and produces sound effects and echoes that make the action seem to envelop you.

The amplifier offers Dolby Surround as one of the pre-programmed sound fields. If you have rear or center speaker(s), we recommend that you customize the Dolby Surround sound field by selecting the appropriate center mode to take advantage of Dolby Pro Logic Surround sound.

## Parameter

Variable of sound that composes sound image, such as tone or delay time. You can customize the pre-programmed sound fields by adjusting parameters to suit your listening situation.

## Sound field

Sound pattern produced by a sounding source or sources in a given environment due to direct and reflected sounds and the acoustics of the environment. The amplifier offers 5 pre-programmed sound fields (ROCK, POPS, CLASSIC, MOVIE and GAME) to let you enjoy surround sound easily.

## Surround sound

Sound that consists of three elements: direct sound, early reflected sound (early reflections) and reverberative sound (reverberation). The acoustics where you hear the sound affect the way these three sound elements are heard. These sound elements are combined in such a way that you can actually feel the size and the type of a concert hall.

- **Types of sound**

Early reflections      Reverberation

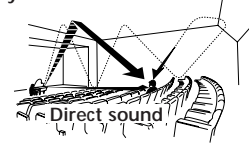

- **Transition of sound from rear speakers**

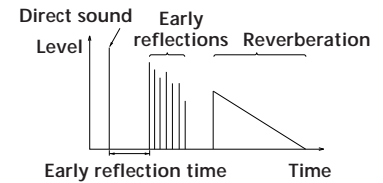

## Test tone

Signal given out by the amplifier for adjusting the speaker volume. The test tone will come out as follows:

- **In a system with a center speaker (NORMAL/WIDE/3 CH modes)**  
The test tone is output from the front L (left), center, front R (right), and rear speakers in succession.

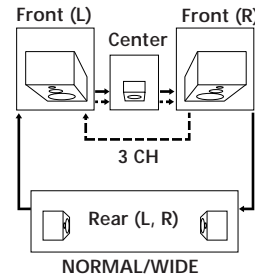

- **In a system without a center speaker (PHANTOM mode)**  
The test tone is output from the front and the rear speakers alternately.

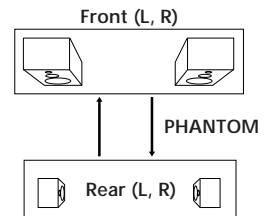



**A, B**

- Adjusting
  - delay time 12
  - speaker volume 12
  - volume 8
- Audio/video component hookups 5

**C**

- Center mode 11, 16
  - NORMAL mode 11, 16
  - PHANTOM mode 11, 16
  - 3 CH mode 11, 16
  - WIDE mode 11, 16
- Choosing surround mode 10
- Connecting. *See* Hookups

**D, E, F, G**

- DBFB 8
- Delay time 12, 16
- Dolby Pro Logic Surround 16
  - getting the most out of 11
- Dolby Surround sound 10, 16
  - center mode 11, 16

**H, I, J, K, L, M**

- Hookups
  - AC power cord 7
  - audio/video component 5
  - overview 4
  - speakers 6

**N, O**

- NORMAL mode 11, 16

**P**

- PHANTOM mode 11, 16
- Program source selecting 8

**Q**

- Quick reference guide (back cover)

**R**

- Rear panel 5, 6, 7, 18
- Recording
  - on a tape or video tape 9
- Remote 9, 10, 11, 12, 13, 19
  - controlling Sony components 9

**S**

- Selecting a program source using the remote 9
- Sound field preset 13
- Speakers
  - connection 7
  - placement 6
- Surround sound 10, 16

**T**

- Test tone 12, 16
- 3 CH mode 11, 16
- Troubleshooting 14

**U, V**

- Unpacking 4

**W, X, Y, Z**

- WIDE mode 11, 16

**Names of controls**

**Buttons**

- ANT TV/VTR 19
- BAND 19
- BASS 8
- CD 8
- CENTER 12
- CENTER MODE 11
- CH 19
- DBFB ON/OFF 8
- DISC SKIP 19
- DOLBY 10, 11
- HALL 10
- LEVEL CONTROL CENTER 12
- LEVEL CONTROL REAR 12
- PHONO 8
- POWER 8
- REAR 12
- SIMULATED 10
- SOUND FIELD 13
- SURROUND DELAY 12
- SURROUND MODE 10
- SURROUND ON/OFF 10
- SURROUND T.TONE 12
- SYSTEM POWER 9
- TAPE 8
- TREBLE 8
- TUNER 8
- TV POWER 19
- TV/VIDEO 19
- VIDEO 1 8
- VIDEO 2 8
- VOL 19
- ◀▶ 19
- ◀▶▶ 19
- ⏏ 19
- ◀/▶ 19
- 19
- +/- 11
- Number 19

**Controls**

- MASTER VOLUME 8

**Jacks**

- PHONES 8

**Indicators**

- DBFB 8
- DOLBY PRO LOGIC 10
- SOUND CONTROL (BASS/TREBLE/CENTER/REAR) 8
- SURROUND (DOLBY/HALL/SIMULATED) 10

**Other**

- 4

## Rear Panel Descriptions

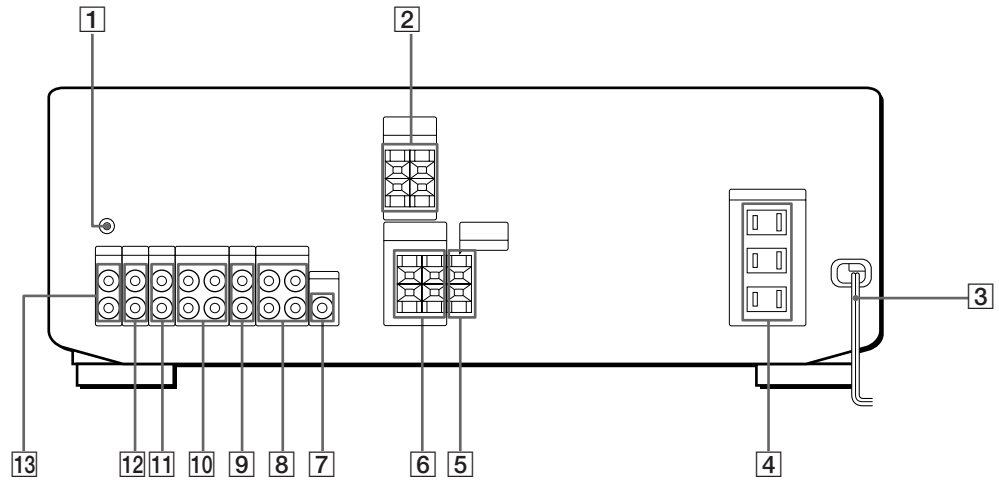

1  $\varnothing$  ground terminal

2 REAR SPEAKERS

3 AC power cord

4 SWITCHED AC OUTLET

5 CENTER SPEAKER

6 FRONT SPEAKERS

7 MIX

8 VIDEO 1

9 VIDEO 2

10 TAPE

11 CD

12 TUNER

13 PHONO

## Remote Button Descriptions

For buttons not described on previous pages and buttons with names different from the buttons on the amplifier.

Remote Button	Operates	Function
1-10	CD player	Selects track or disc numbers.
>10	CD player	Selects track numbers over 10.*
TRACK + 1-10 + ENTER	CD player	Selects track numbers.**
DISC + 1-10 + ENTER	CD player	Selects disc numbers.
BAND	Tuner	Selects the band.
TUNER +/-	Tuner	Scans and selects stations.
DISC SKIP +/-	CD player	Skips discs (CD player with multi-disc changer only.)
DECK A/B	Tape deck	Selects operation mode between deck A and B
⏩/⏪	Tape deck/ VCR	Fastforwards or rewinds.
⏮/⏭	CD player	Skips tracks.
⏸	CD player/ Tape deck/ VCR	Pauses play or record. (Also starts recording with components in record standby.)
▶	CD player/ Tape deck/ VCR	Starts play.
■	CD player/ Tape deck/ VCR	Stops play.
◀	Tape deck	Starts play on the reverse side.

Remote Button	Operates	Function
TV/VIDEO	TV	Selects input signal: TV input or video input.
TV POWER	TV	Turns on or off the power of TV.
VOL +/-	TV	Adjusts the volume.
CH +/-	TV/VCR	Selects the preset channels.
VTR 2/3	VCR	Selects the operation of VCR as follows: VTR 2 (8 mm) VTR 3 (VHS)
VTR POWER	VCR	Turns on or off the power of VCR.
ANT TV/VTR	VCR	Selects output signal from the antenna terminal: TV signal or VCR program.

\* Example:

To select 24th track in the disc: >10 → 2 → 4

\*\* Example:

To select 5th track in the disc: TRACK → 5 → ENTER

To select 24th track in the disc: TRACK → 2 → 4 → ENTER

## Selecting a Component

Example: Playing a CD

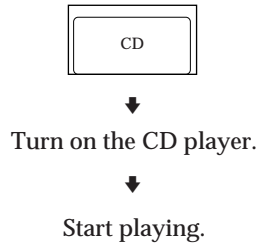

## Choosing a Surround Mode

Example: Listening to Dolby Pro Logic Surround on a Laser disc

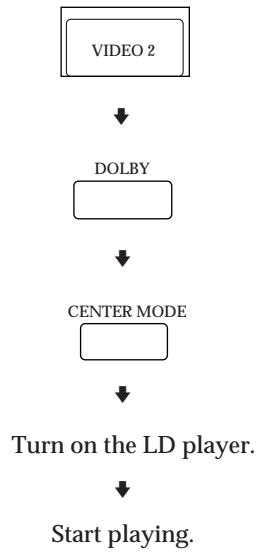

## Using Preset Sound Fields

Example: Listening to classic music on a CD

