

**SONY**<sup>®</sup>

3-856-825-13(1)

# ***CD Radio Cassette-Corder***

---

Operating Instructions

***CFD-646  
CFD-C646  
CFD-656***

—  
©1996 by Sony Corporation

CFD-646/656.E.3-856-825-1X.U/CA

## Warning

To prevent fire or shock hazard, do not expose the player to rain or moisture.

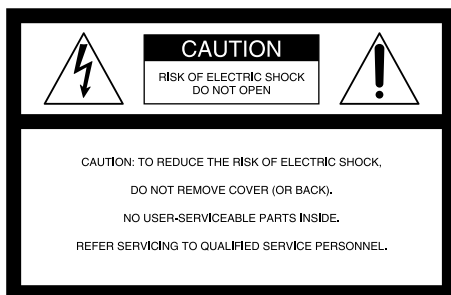

This symbol is intended to alert the user to the presence of uninsulated "dangerous voltage" within the product's enclosure that may be of sufficient magnitude to constitute a risk of electric shock to persons.



This symbol is intended to alert the user to the presence of important operating and maintenance (servicing) instructions in the literature accompanying the appliance.

## CAUTION

The use of optical instruments with this product will increase eye hazard.

## Warning

Do not install the appliance in a confined space, such as a bookcase or built-in cabinet.

## For customers in Canada

To prevent electric shock, match wide blade of plug to wide slot, fully insert.

## CAUTION

You can use this player on AC power source only. You cannot use it on batteries.

When you disconnect the AC power cord, the memory data for the preset memory for radio will be erased after about 60 minutes.

Re-enter them when you use the player again.

## Information

### For customers in the United States

This equipment has been tested and found to comply with the limits for a Class B digital device, pursuant to Part 15 of the FCC Rules. These limits are designed to provide reasonable protection against harmful interference in a residential installation. This equipment generates, uses and can radiate radio frequency energy and, if not installed and used in accordance with the instructions, may cause harmful interference to radio communications. However, there is no guarantee that interference will not occur in a particular installation. If this equipment does cause harmful interference to radio or television reception, which can be determined by turning the equipment off and on, the user is encouraged to try to correct the interference by one or more of the following measures:

- Reorient or relocate the receiving antenna.
- Increase the separation between the equipment and receiver.
- Connect the equipment into an outlet on a circuit different from that to which the receiver is connected.
- Consult the dealer or an experienced radio/TV technician for help.

You are cautioned that any changes or modifications not expressly approved in this manual could void your authority to operate this equipment.

## Owner's Record

The model and serial numbers are located at the rear of the CD radio cassette-corder. Record these numbers in the spaces provided below. Refer to these numbers whenever you call upon your Sony dealer regarding this product.

Model No. \_\_\_\_\_

Serial No. \_\_\_\_\_

## About This Manual

The instructions in this manual are for the CFD-646 and CFD-656. Before you start reading, check your model number. The CFD-646 is the model used for illustration purposes.

---

# Table of contents

---

---

## Basic Operations

- 4 Playing a CD
  - 6 Listening to the radio
  - 8 Playing a tape
  - 10 Recording on a tape
- 

### The CD Player

- 12 Using the display
- 13 Locating a specific track
- 14 Playing tracks repeatedly  
(Repeat Play)
- 16 Playing tracks in random order  
(Shuffle Play)
- 17 Creating your own program  
(Program Play)

### The Radio

- 19 Presetting radio stations
- 20 Playing preset radio stations

### Setting Up

- 21 Hooking up the system
- 24 Adjusting the audio emphasis  
(Sound Mode/MEGA BASS)

### Additional Information

- 25 Precautions
- 27 Troubleshooting
- 29 Maintenance
- 30 Specifications
- 31 Index

## Playing a CD

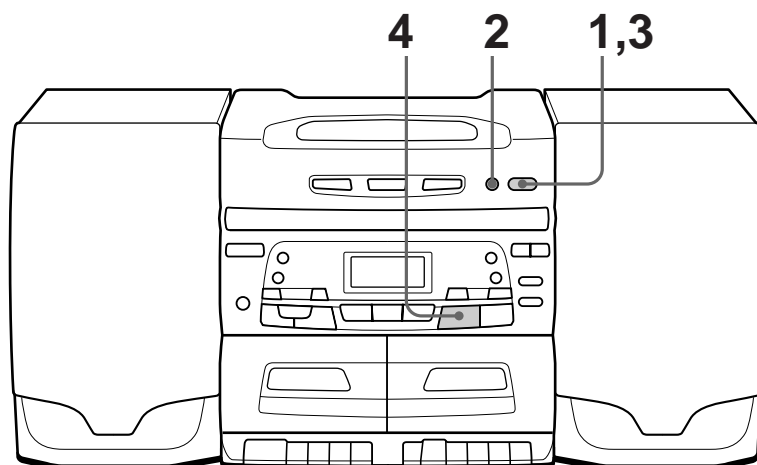

For hookup instructions, see pages 21 – 23.

- 1** OPEN/CLOSE  

Press OPEN/CLOSE (direct power-on) and place the CD on the CD tray. Be sure to align the center of the CD with the center of the CD tray.

**Notes**

- You can't play 3-inch (8 cm) CDs even with an adaptor for single-CDs.
- Place one CD each only on the CD tray. If you place one CD over another and close the CD tray, you will not be able to pull out the tray.

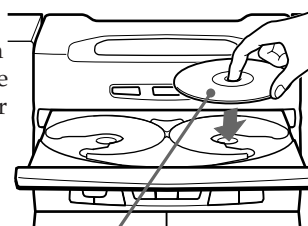

With the label side up

- 2** DISC CHANGE  

Press DISC CHANGE to turn the CD tray, and place second and third CD on the CD tray.

- 3** OPEN/CLOSE  

Press OPEN/CLOSE to close the CD tray.

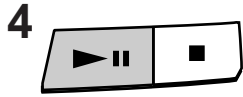

4 Press **▶||**.  
The player plays all the tracks of all the CDs in the CD tray once.

**Display**

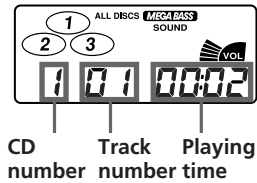

**Use these buttons for additional operations**

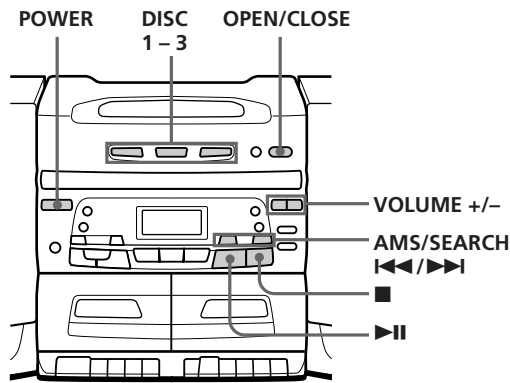

**Tips**

- You can change a CD while playing another. Press OPEN/CLOSE to pull out the CD tray and change the CD. Press OPEN/CLOSE again to close the CD tray. Do not close the CD tray by hand, as that may cause trouble.
- Next time you want to listen to a CD, just press **▶||**. The player turns on automatically and starts playing the CD.

To	Press
Adjust the volume	VOLUME +/-
Stop playback	■
Pause playback	▶   Press again to resume play after pause.
Go to the next track	AMS/SEARCH ▶▶
Go back to the previous track	AMS/SEARCH ◀◀
Remove the CD	OPEN/CLOSE
Turn on/off the player	POWER
Play only one CD	DISC 1, DISC 2 or DISC 3 (desired DISC SELECT)

## Listening to the radio

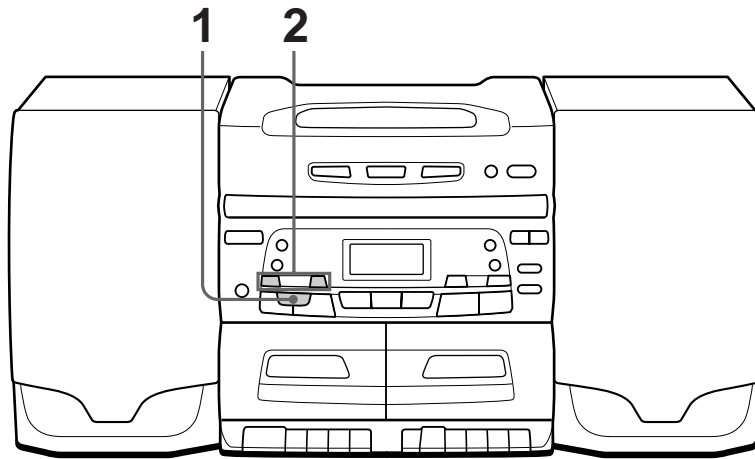

For hookup instructions, see pages 21 – 23.

1

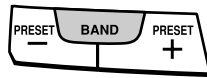

Press BAND until the band you want appears in the display (direct power-on).

Display

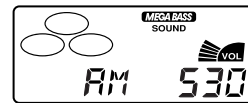

2

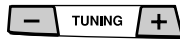

Hold down TUNING +/- until the frequency digits begin to change in the display.

The player automatically scans the radio frequencies and stops when it finds a clear station.

If you can't tune in a station, press the button once at a time.

Indicates an FM stereo broadcast.

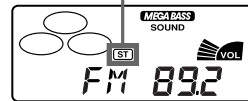

Use these buttons for additional operations

POWER    PLAY MODE/  
                 MONO/ST    VOLUME +/-

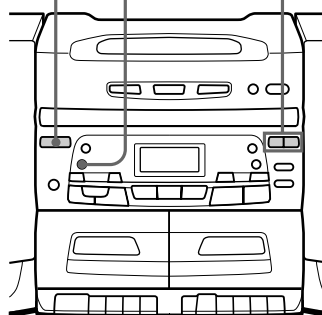

**Tips**

- If the FM broadcast is noisy, press PLAY MODE/MONO/ST until "Mono" appears in the display and the radio will play in monaural.
- Next time you want to listen to the radio, just press RADIO or BAND. The player turns on automatically and starts playing the previous station.

To	Press
Adjust the volume	VOLUME +/-
Turn on/off the radio	POWER

**To improve broadcast reception**

Reorient the aerial for FM.

Reorient the AM loop aerial (supplied). Locate it away from the player during AM program reception.

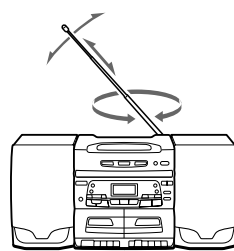

for FM

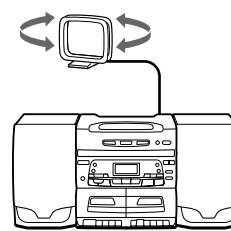

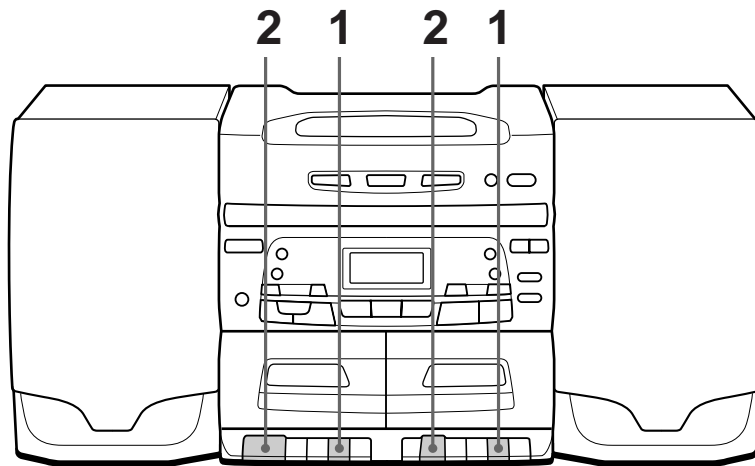

for AM

## Playing a tape



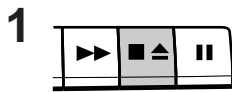

For hookup instructions, see pages 21 – 23.

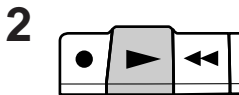
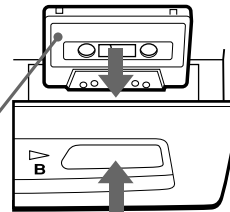

Press  to open the tape compartment and insert a recorded tape. Close the compartment.

With the side you want to play facing forward



Press .  
The player turns on (direct power-on) and starts playing.

Display





Use these buttons for additional operations

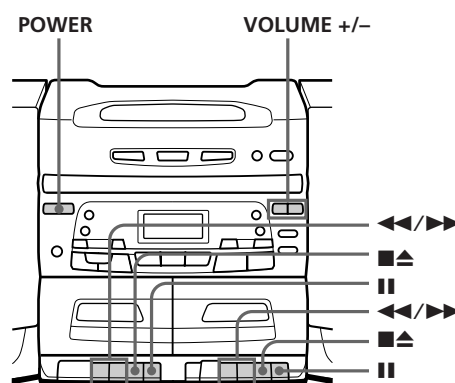

**Note**

During playback, do not press buttons on the other deck. Otherwise the playback speed may change.

**Tips**

- Next time you want to listen to a tape, just press ▶. The player turns on automatically and starts playing the tape.
- For the best results, use TYPE I (normal) tape.

To	Press
Adjust the volume	VOLUME +/-
Stop playback	■▲
Fast-forward or rewind the tape	▶▶ or ◀◀
Pause playback	
	Press the button again to resume play after pause.
Eject the cassette	■▲
Turn on/off the player	POWER

## Recording on a tape

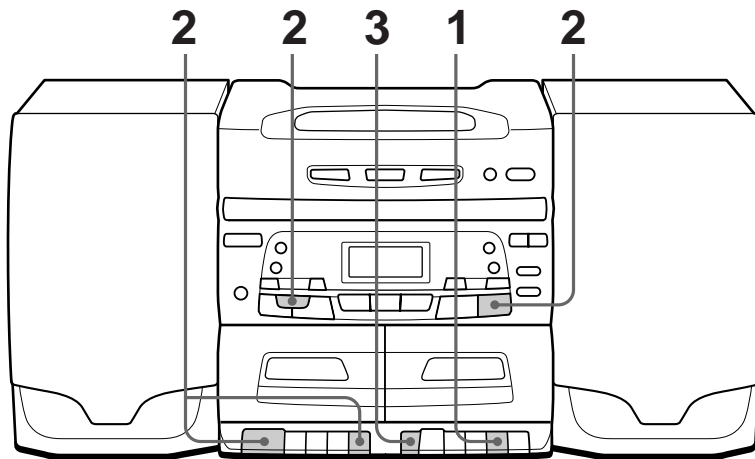

For hookup instructions, see pages 21 – 23.

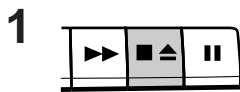

Press to open the tape compartment on deck B and insert a blank tape.

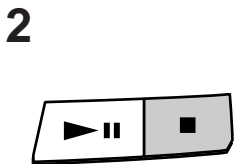
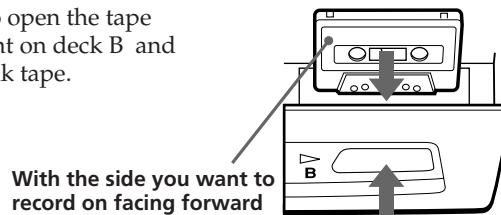

Select the program source you want to record.

To record from the CD player, insert a CD (see page 4) and press on the CD section.

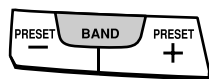

To record from the radio, press BAND and tune in the station you want (see page 6.)

### Display

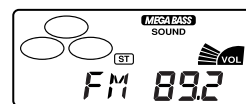
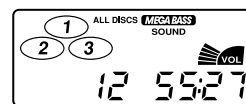

### Deck A

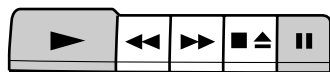

To record from a tape, insert a recorded tape into deck A and press and simultaneously on deck A.



### 3 Deck B

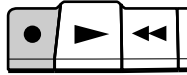

Start recording.

To record, press ● on deck B (▶ is depressed automatically).

#### Tips

- Adjusting the volume or the audio emphasis (see page 24) will not affect the recording level.
- For the best results, use TYPE I (normal) tape for recording.
- When recording from two or three CDs, the player pauses recording and makes a blank between the tracks while CDs are being changed. When changing of CDs is finished, recording resumes automatically.
- To erase a recording, proceed as follows:
  - 1 Insert the tape whose recording you want to erase into the tape compartment on deck B.
  - 2 Press TAPE until "TAPE" appears in the display window.
  - 3 Press ● on deck B.

#### Notes

- Do not press ▶▶ or ◀◀ while recording on a tape.
- If the AM program makes a whistling sound after you've pressed ● in step 3, move the AM loop aerial connected to the player as far as possible.

#### Use these buttons for additional operations

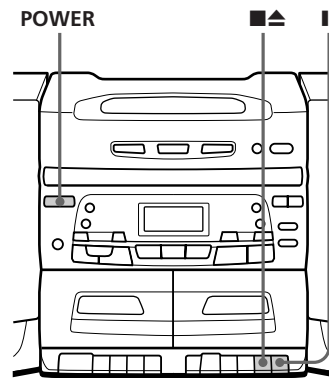

To	Press
Stop recording	■▲ on deck B
Pause recording	on deck B Press the button again to resume recording.
Turn on/off the player	POWER

## Using the display

You can check information about the CD using the display.

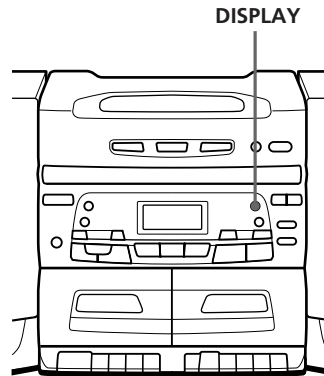

**Tip**

When two or three CDs are placed, select the CD you want to check information about by pressing DISC 1, DISC 2 or DISC 3.

### Checking the total track numbers and playing time of the current CD

Press DISPLAY in stop mode.

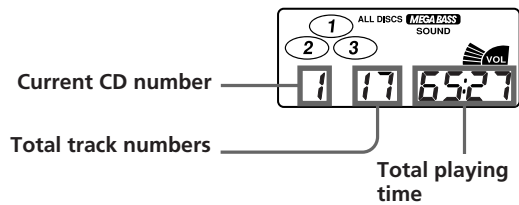

### Checking the remaining time of the current CD

Press DISPLAY while playing a CD.

To display	Press DISPLAY
The current track number and the remaining time on the current track*	Once
Remaining time on the CD and the number of tracks left	Twice
The current track number and playing time	Three times

\* For a track whose number is more than 16, the remaining time appears as "--:--".

## Locating a specific track

You can quickly locate any track using the number buttons. You can also find a specific point in a track while playing a CD.

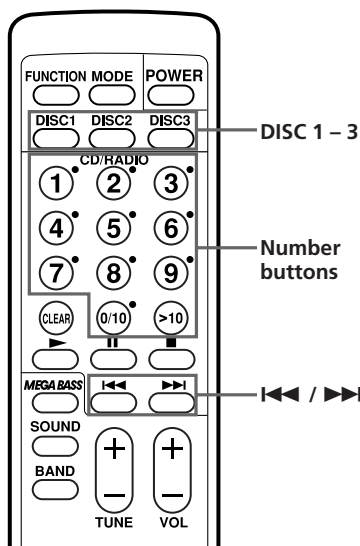

### Note

You cannot locate a specific track if "SHUF" or "PGM" is lit in the display. Turn off the indication by pressing ■.

### Tip

When you locate a track numbered over 10, press >10 first, then the corresponding number buttons.  
Example:  
To play track number 23, press >10 first, then 2 and 3.

To locate	Press
a specific track directly	one of the DISC 1 to 3 buttons to select the CD and a number button of the track.
a point while listening to the sound	▶▶ (forward) or ◀◀ (backward) while playing and hold down until you find the point.
a point while observing the display	▶▶ (forward) or ◀◀ (backward) in pause and hold down until you find the point.

## Playing tracks repeatedly

### (Repeat Play)

You can play tracks repeatedly in normal, shuffle or program play modes (see pages 16 – 18.).

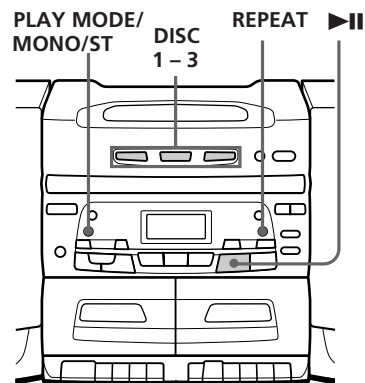

#### Playing a single CD repeatedly

- 1 Press REPEAT to display "REPEAT" in the display.
- 2 Press DISC 1, 2, or 3 to select the CD to be played.

#### Playing two or three CDs repeatedly

- 1 Press REPEAT to display "ALL DISCS REPEAT" in the display.
- 2 Press ►|| to start repeat play.

#### Playing tracks of a single CD in random order repeatedly

- 1 Press PLAY MODE/MONO/ST until "SHUF" appears in the display.
- 2 Press REPEAT to display "REPEAT" in the display.
- 3 Press DISC 1, 2, or 3 to select the CD to be played.

**Playing tracks of two or three CDs in random order repeatedly**

- 1** Press PLAY MODE/MONO/ST until "ALL DISCS SHUF" appears in the display.
- 2** Press REPEAT to display "REPEAT" in the display.
- 3** Press ►|| to start repeat play.

**Playing programmed tracks repeatedly**

- 1** Program tracks (see page steps 1 – 3 on page 17).
- 2** Press REPEAT to display "REPEAT" in the display.
- 3** Press ►|| to start repeat play.

**To cancel repeat play**

Press REPEAT until "REPEAT" disappears in the display.

---

## Playing tracks in random order

### (Shuffle Play)

You can play tracks in random order.

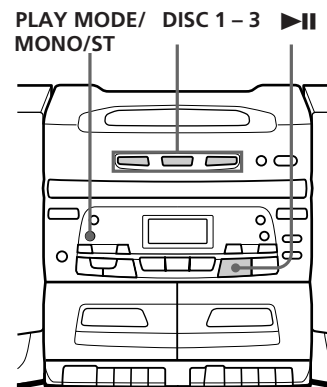

#### Playing tracks of a single CD in random order

- 1 Press PLAY MODE/MONO/ST until "SHUF" appears in the display.
- 2 Press DISC 1, 2, or 3 to select the CD to be played.

#### Playing tracks of two or three CDs in random order

- 1 Press PLAY MODE/MONO/ST until "ALL DISCS SHUF" appears in the display.
- 2 Press ►► to start shuffle play.

#### To cancel shuffle play

Press PLAY MODE/MONO/ST until "SHUF" disappears in the display.



## Creating your own program

### (Program Play)

You can make a program of up to 20 tracks from all the CDs in the order you want them to be played.

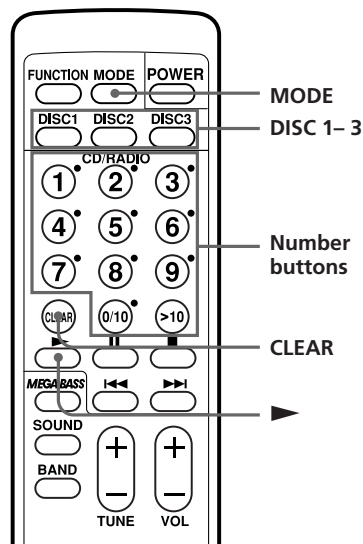

The CD Player

#### Tips

- You can select the track on the player. Press AMS/SEARCH ◀◀ / ▶▶ then press ENTER/ MEMORY instead of the number buttons.
- You can play the same program again, since the program is saved until you open the CD tray.
- You can record your own program. After you've created the program, insert a blank tape into deck B and press ● on deck B to start recording.

- 1 Press MODE until "ALL DISCS PGM" appears in the display.
- 2 Press DISC 1 to 3 to select the CD.
- 3 Press the number buttons for the tracks you want to program in the order you want. You can program up to 20 tracks.

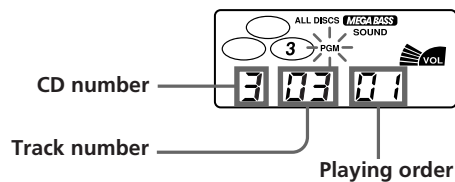

**If you made a mistake**, press CLEAR and re-enter the track number.

**To program additional tracks from another CD**, repeat steps 2 and 3.

- 4 Press ▶ to start program play.

continued

---

## Creating your own program (Program Play) (continued)

### To cancel Program Play

Press MODE until "PGM" disappears in the display.

### To check the order of tracks before play

Press ENTER/MEMORY on the player.

Every time you press the button, the track number appears in the programmed order.

### To change the current program

To	Do this
Erase the last track in the program	1 Press CLEAR. Every time you press the button, the last track in the program is cleared. 2 Re-enter the track numbers.
Change the whole program completely.	Press ■. Then create a new program following the programming procedure.

## Presetting radio stations

You can store radio stations into the player's memory. You can preset up to 20 radio stations, 10 for each FM or AM in any order.

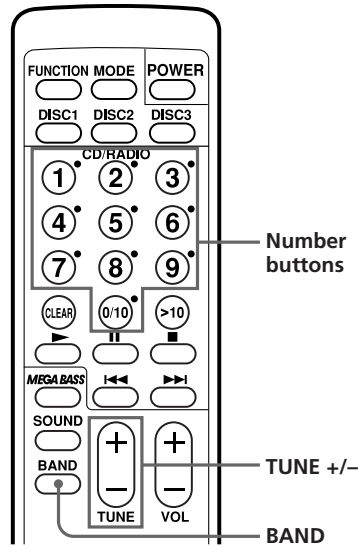

The Radio

### Tip

To preset radio stations on the player, proceed as follows:

- 1 Select the band and tune in a station you want.
- 2 Hold down ENTER/MEMORY for about 2 seconds.
- 3 Decide on a preset number for the station (1 to 10) by pressing PRESET +/-.
- 4 Press ENTER/MEMORY.

- 1 Press BAND until the band you want appears in the display.
- 2 Tune in a station you want.
- 3 Hold down the number buttons that you want to preset the new station for about 2 seconds.  
The new station replaces the old one.

---

## Playing preset radio stations

Once you've preset the stations, use the number buttons to tune in your favorite stations.

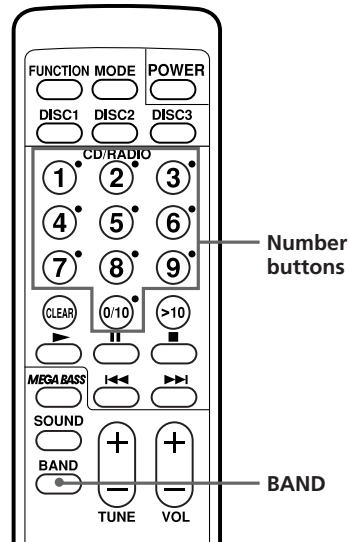

### Tip

You can tune in a preset station with the player. Use PRESET +/- instead of the number buttons.

- 1 Press BAND to select FM or AM.
- 2 Press the number buttons to tune in a stored station.

## Hooking up the system

Make sure you turn off the power before making any connections.

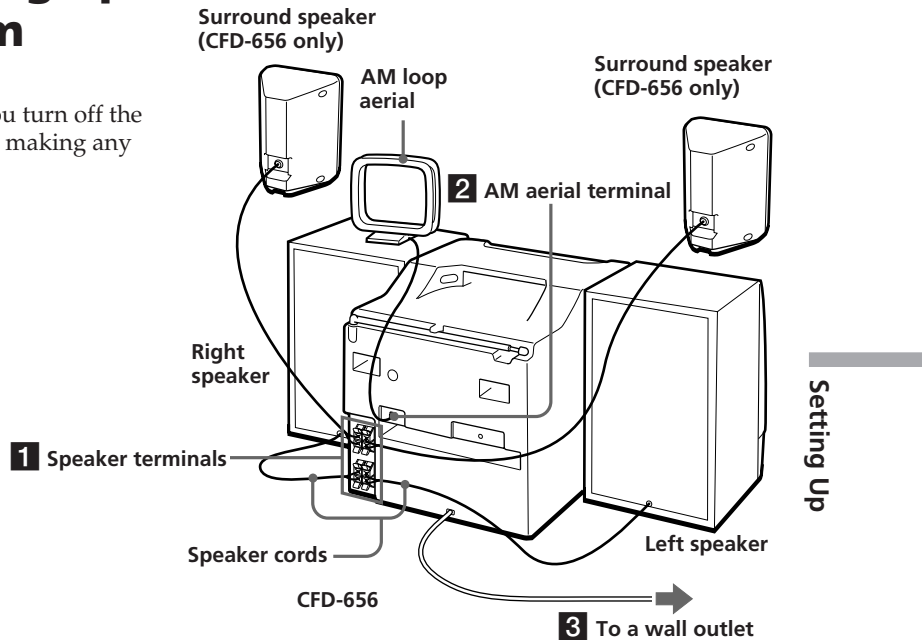

### Tips

- To detach the speakers, slide the speaker box all the way up and away from the player.
- Connect the speakers for this unit only to the speaker terminals of this unit. If you connect any other speakers or equipment, malfunction may occur.

### Note

When transporting, make sure to carry the player. Do not carry the speakers since they are not locked.

### 1 Hooking up the speakers

- 1 Align the grooves and slide the speaker box down until it snaps into place.

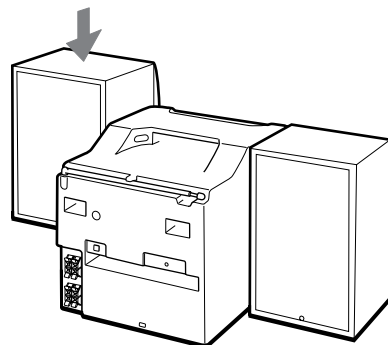

continued

---

## Hooking up the system (continued)

- 2** Connect the black wires to (-) minus and the red wires to (+) plus terminals; the right speaker wires to the R and the left speaker wires to the L terminals.

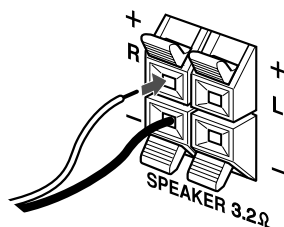

### Connecting surround speakers (CFD-656 only)

You can enjoy a rich and spacious effect by connecting surround speakers.

Connect the black wires to (-) minus and the grey wires to (+) plus terminals.

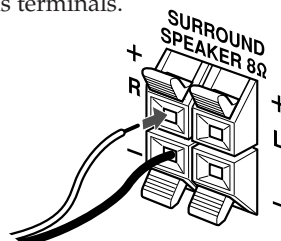

To turn off the surround effect, disconnect the surround speakers.

## **2** Hooking up the aerial

AM loop aerial (supplied)

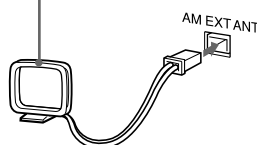

Reorient the aerial to improve broadcast reception.

### Setting up the AM loop aerial

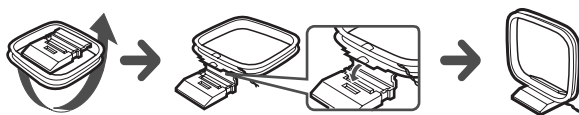

---

### **3** Connecting the AC power cord

Insert the AC power cord to the wall outlet.

The POWER STANDBY indicator lights up to indicate when the player is connected to the power source. The indicator lights regardless of whether the power is on or off (Australian model only).

### **4** Inserting batteries into the remote

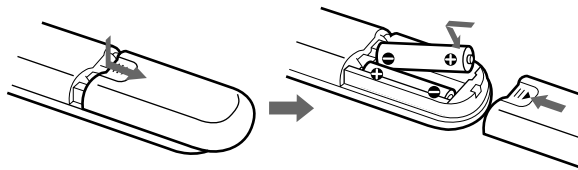

Insert two size AA (R6) batteries (not supplied)

#### **Replacing batteries**

With normal use, the batteries should last for about six months. When the remote no longer operates the player, replace all the batteries with new ones.

# Adjusting the audio emphasis

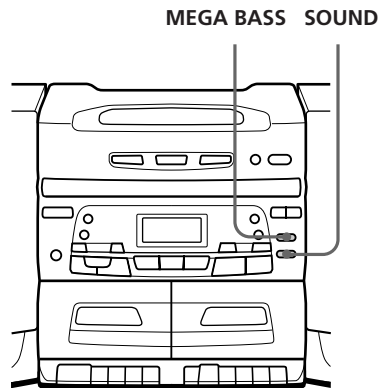

(Sound Mode/MEGA BASS)

You can adjust the audio emphasis of the sound you are listening to.



### Selecting the sound characteristic

Press SOUND to select the audio emphasis you want.

Choose	To get
Normal mode (no indication)	The whole dynamic range for music such as classical music
	Powerful, clean sounds, emphasizing low and high range audio.
	The presence of vocals, stressing middle range audio.
	Light, bright sounds emphasizing high and middle range audio.

### Reinforcing the bass sound

Press MEGA BASS.

“MEGA BASS” appears in the display. To return to normal sound, press the button again.



## Precautions

### On safety

- As the laser beam used in the CD player section is harmful to the eyes, do not attempt to disassemble the casing. Refer servicing to qualified personnel only.
- Should any solid object or liquid fall into the player, unplug the player, and have it checked by qualified personnel before operating it any further.

### On power sources

- For AC operation use the supplied AC power cord; do not use any other type.
- The player is not disconnected from the AC power source (mains) as long as it is connected to the wall outlet, even if the player itself has been turned off.
- Unplug the player from the wall outlet when it is not to be used for an extended period of time.
- When the batteries are not to be used, remove them to avoid damage that can be caused by battery leakage or corrosion.
- The nameplate indicating operating voltage, power consumption, etc. is located at the rear.

### On placement

- Do not leave the player in a location near heat sources, or in a place subject to direct sunlight, excessive dust or mechanical shock.
- Do not place the player on an inclined or unstable place.
- Do not place anything within 10 mm of the side of the cabinet. The ventilation holes must be unobstructed for the player to operate properly and prolong the life of its components.
- If the player is left in a car parked in the sun, be sure to choose a location in the car where the player will not be subjected to the direct rays of the sun.
- Since a strong magnet is used for the speakers, keep personal credit cards using magnetic coding or spring-wound watches away from the player to prevent possible damage from the magnet.
- When you move the player, be sure to first remove the CD(s), otherwise, you may not be able to take out the CD(s) later or trouble with the unit may occur.

continued

---

---

## Precautions (continued)

### On operation

- If the player is brought directly from a cold to a warm location, or is placed in a very damp room, moisture may condense on the lens inside the CD player section. Should this occur, the player will not operate properly. In this case, remove the CD and wait about an hour for the moisture to evaporate.
- If the player has not been used for a long time, set it in the playback mode to warm it up for a few minutes before inserting a cassette.

If you have any questions or problems concerning your player, please consult your nearest Sony dealer.

### Notes on CDs

- Before playing, clean the CD with a cleaning cloth. Wipe the CD from the center out.



- Do not use solvents such as benzine, thinner, commercially available cleaners or anti-static spray intended for vinyl LPs.
- Do not expose the CD to direct sunlight or heat sources such as hot air ducts, nor leave it in a car parked in direct sunlight as there can be a considerable rise in temperature inside the car.

- Do not stick paper or sticker on the CD, nor scratch the surface of the CD.
- After playing, store the CD in its case.

If there is a scratch, dirt or fingerprints on the CD, it may cause tracking error.

### Notes on cassettes

- Break off the cassette tab from side A or B to prevent accidental recording. If you want to reuse the tape for recording, cover the broken tab with adhesive tape.

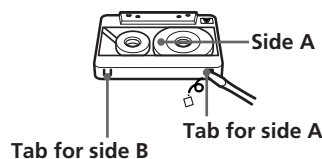

- To record on a tape with its tab broken off, cover the respective tab hole for side A or B with adhesive tape.
- The use of a cassette with more than 90 minutes of play time is not recommended except for long, continuous recording or playback.

# Troubleshooting

	Symptom	Remedy
General	The power is not on.	<ul style="list-style-type: none"> <li>• Connect the AC power cord to a wall outlet securely.</li> </ul>
	There is no audio.	<ul style="list-style-type: none"> <li>• Make sure the function you want to use appears in the display window.</li> <li>• Adjust the volume.</li> <li>• Unplug the headphones when listening through speakers.</li> </ul>
	“no disc” lights in the display even when a CD is in place.	<ul style="list-style-type: none"> <li>• Insert the CD with the label surface up.</li> </ul>
CD Player	The CD does not play.	<ul style="list-style-type: none"> <li>• Make sure that the CD tray is closed.</li> <li>• Place the CD with the label surface up.</li> <li>• Clean the CD.</li> <li>• Take out the CD and leave the CD tray open for about an hour to dry moisture condensation.</li> <li>• Make sure “CD” appears in the display.</li> </ul>
	The sound drops out.	<ul style="list-style-type: none"> <li>• Reduce the volume.</li> <li>• Clean the CD, or replace it if the CD is badly damaged</li> <li>• Place the player in a location free from vibration.</li> </ul>
Radio	The audio is weak or has poor quality.	<ul style="list-style-type: none"> <li>• Move the player away from the TV.</li> <li>• If you are using the remote while listening to AM radio, noise may be heard. This is unavoidable.</li> </ul>
	The picture of your TV becomes unstable.	<ul style="list-style-type: none"> <li>• If you are listening to an FM program near the TV with an indoor antenna, move the player away from the TV.</li> </ul>

continued

## Troubleshooting (continued)

	Symptom	Remedy
Tape Player	The tape does not move when you press an operation button.	<ul style="list-style-type: none"> <li>• Close the cassette compartment securely.</li> </ul>
	The REC ● button does not function/The tape does not play.	<ul style="list-style-type: none"> <li>• Make sure the safety tab on the cassette is in place.</li> <li>• Make sure "TAPE" appears in the display.</li> </ul>
	The tape does not erase completely.	<ul style="list-style-type: none"> <li>• Clean the erasing head (see page 29.)</li> </ul>
	The tape does not record.	<ul style="list-style-type: none"> <li>• Make sure the tape is inserted properly.</li> <li>• Make sure the safety tab of the cassette is in place.</li> </ul>
	The audio is weak/The audio quality is poor.	<ul style="list-style-type: none"> <li>• Clean the heads, pinch rollers and capstans (See page 29).</li> <li>• Demagnetize the heads using a demagnetizer (see page 29).</li> </ul>
	The sound is distorted.	<ul style="list-style-type: none"> <li>• The TYPE II (high position) or TYPE IV (metal) tape is being used. Use TYPE I (normal) tape only.</li> </ul>
Remote	The remote does not function.	<ul style="list-style-type: none"> <li>• Replace all the batteries in the remote with new ones if they are weak.</li> <li>• Make sure that you are pointing the remote at the remote sensor on the player.</li> <li>• Remove any obstacles in the path of the remote and the player.</li> <li>• Make sure the remote sensor is not exposed to strong light such as direct sunlight or fluorescent lamp light.</li> <li>• Move closer to the player when using the remote.</li> </ul>
Others	There is no surround effect (CFD-656 only).	<ul style="list-style-type: none"> <li>• Connect two supplied surround speakers.</li> </ul>

The player uses a built-in micro computer for its various operations. Due to change in power supply conditions, etc., operation may sometimes become unstable. After trying the above remedies, if the player still does not function properly, press RESET at the rear with a pointed material. If the problem persists, please consult your nearest Sony dealer.

---

## Maintenance

### Cleaning the tape heads and tape path

Wipe the heads, the pinch rollers and the capstans with a cleaning swab slightly moistened with cleaning fluid or alcohol after every 10 hours of operation for optimum playback and recording quality. To make the best possible recording, however, we recommend that you clean all surfaces over which tape travels before each recording.

#### Deck A

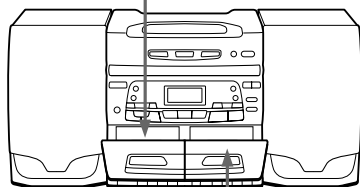
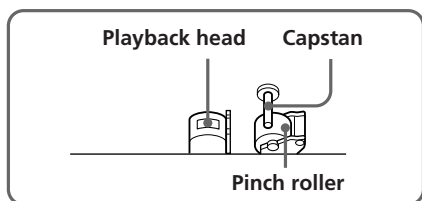

#### Deck B

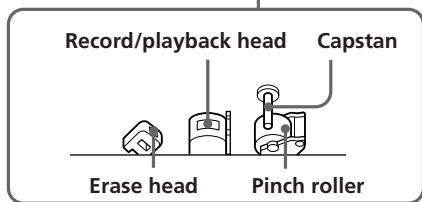

After cleaning, insert a tape when the areas cleaned are completely dry.

### Demagnetizing the tape heads

After 20 to 30 hours of use, enough residual magnetism will have built up on the tape heads to begin to cause loss of high frequency sound and hiss. At this time, you should demagnetize the heads and all metal parts in the tape path with a commercially available tape head demagnetizer.

### Cleaning the cabinet

Clean the cabinet, panel and controls with a soft cloth slightly moistened with a mild detergent solution. Do not use any type of abrasive pad, scouring powder, or solvent, such as alcohol or benzene.

---

# Specifications

## AUDIO POWER SPECIFICATIONS

### POWER OUTPUT AND TOTAL HARMONIC DISTORTION

With 3.2-ohm loads, both channel driven from 150 – 8,000 Hz; rated 4 W per channel- minimum RMS power, with no more than 10 % total harmonic distortion in AC operation.

## Other Specifications

### CD player section

#### System

Compact disc digital audio system

#### Laser diode properties

Material: GaAlAs

Wave length: 780 nm

Emission duration: Continuous

Laser output: Less than 44.6  $\mu$ W

(This output is the value measured at a distance of about 200 mm from the objective lens surface on the optical pick-up block with 7 mm aperture.)

#### Spindle speed

200 r/min (rpm) to 500 r/min (rpm) (CLV)

#### Number of channels

2

#### Frequency response

20 – 20,000 Hz +1/-2 dB

#### Wow and flutter

Below measurable limit

### Radio section

#### Frequency range

FM: 87.6 – 108 MHz

AM: 531 – 1,602 kHz (Australian model)

530 – 1,710 kHz (Other models)

#### Aerials

FM: Telescopic aerial

AM: External aerial terminal

### Cassette-corder section

#### Recording system

4-track 2 channel stereo

#### Fast winding time

Approx. 140 s (sec.) with Sony cassette C-60

#### Frequency response

TYPE I (normal): 80 – 10,000 Hz

## General

### Speaker

Full range: 10 cm (4 in.) dia.,  
3.2 ohms, cone type (2)

### Surround speaker (CFD-656 only)

10 cm (4 in.) dia., 8 ohms, cone type (2)

### Outputs

Headphones jack (stereo minijack):

For 16 – 64 ohms impedance headphones

Speaker terminals: For supplied 3.2 ohms  
impedance speaker

Surround speaker terminals (CFD-656 only):

Terminals for supplied 8 ohms impedance speaker

### Power output (excluding US model)

4.3 W + 4.3 W (at 3.2 ohm, 10 % harmonic  
distortion)

### Power requirements

For CD radio cassette-corder:

230-240 V AC, 50 Hz (Australian model)

120 V AC, 60 Hz (Other models)

For remote:

3 V DC, 2 size AA (R6) batteries

### Power consumption

AC 27 W

### Dimensions

Approx. 646 × 286.5 × 355 mm (w/h/d)

(25 1/2 × 11 3/8 × 14 inches) (incl. projecting parts)

### Mass

Approx. 10.5 kg (23 lb. 2 oz)

### Supplied accessories

Remote control (1)

AM loop aerial (1)

Surround speakers (2) (CFD-656 only)

Design and specifications are subject to change without notice.

### Optional accessories

Sony MDR headphone series

---

# Index

## A

Audio emphasis 24

## B

Batteries for remote 23

## C

CD player 12

Cleaning

    cabinet 29

    tape heads and tape  
    path 29

Connecting

    AC power cord 23

    speakers 21

Creating your own program  
17

## D, E, F, G, H

Demagnetizing the tape  
heads 29

Display 12

## I, J, K

Improving broadcast  
reception 7

## L

Listening to the radio 6

Locating a specific track 13

## M, N, O

MEGA BASS 24

## P, Q

Playing

    a CD 4

    a tape 8

    preset radio stations 20

    tracks repeatedly 14

Presetting radio stations 19

Program Play 17

## R

Radio stations

    playing 20

    presetting 19

Recording

    on a tape 10

Repeat Play 14

## S

Selecting

    audio emphasis 24

    tracks 13

Setting up 21

Shuffle Play 16

Sound mode 24

SORROUND 22

## T

Troubleshooting 27

## U, V, W, X, Y, Z

Using the display 12

Sony Corporation Printed in China



CFD-646/656.E.3-856-825-1X.U/CA