

Compact Hi-Fi Stereo System

Operating instructions



LBT-N355KR

WARNING

To prevent fire or shock hazard, do not expose the unit to rain or moisture.

To avoid electrical shock, do not open the cabinet. Refer servicing to qualified personnel only.

Do not install the appliance in confined space, such as a bookcase or built-in cabinet.

Laser component in this product is capable of emitting radiation exceeding the limit for Class 1.

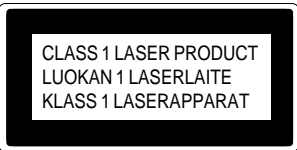

This appliance is classified as a CLASS 1 LASER product. The CLASS 1 LASER PRODUCT MARKING is located on the rear exterior.

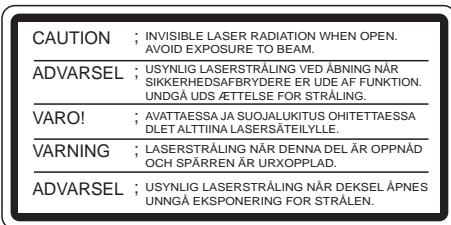

This caution label is located inside the unit.

Welcome !

Thank you for purchasing the Sony Hi-Fi Component System. This series is packed with fun features. Here are just a few:

- DBFB (Dynamic Bass Feedback) system that boosts low frequency range audio to provide deep, powerful bass sound
- A preset feature, that lets you store and recall up to 30 of your favourite radio stations
- A graphic equalizer that lets you adjust the audio quality to match 10 music types
- A loop play function that lets you play a short portion of a track repeatedly like a sampler on the CD player
- A timer that lets you set the CD player, tape player or radio to turn on and off whenever you want
- A dual tape deck that lets you record from the radio, CD player or from the other tape deck and relay play from both decks
- A CD player that lets you play up to 5 CDs in a row
- A music clip feature, that lets you create groups of favourite tracks from your CDs
- A remote that lets you control the music from your seat

Table of Contents

Chapter 1: Setting Up

- Connecting the Stereo 4
- Inserting the Batteries 6
- Setting the Clock 6

Chapter 2: the CD Player

- Playing CDs (normal play) 7
- Playing Tracks in Random Order (shuffle play) 8
- Playing Tracks in the Desired Order (programme play) 9
- Playing Tracks Repeatedly (repeat play) 9
- Playing Tracks with Repeating a Specified Portion (loop play) 10
- Grouping Tracks (music clip) 10

Chapter 3: the Radio

- Listening to the Radio 12
- Presetting Radio Stations 13
- Playing Preset Radio Stations 13

Chapter 4: the Tape Player

- Playing a Tape 14
- Recording a CD 14
- Recording a CD: Selecting Tape Length (tape select edit) 16
- Recording a CD: Specifying Tape Length (time edit) 16
- Recording a CD: Specifying Track Order (programme edit) 17
- Recording From the Radio 18
- Recording From Another Tape (dubbing) 18

Chapter 5: Sound Adjustment

- Adjusting the Sound 20
- Selecting the Audio Emphasis 20
- Adjusting the Audio Emphasis 21
- Making Your Personal Audio Emphasis File (personal file) 21

Chapter 6: Additional Features

- Falling Asleep to Music 23
- Waking up to Music 23
- Timer-Recording Radio Programme 24
- Microphone Mixing 25
- Karaoke: Singing Along 25
- Connecting Optional Equipment 26

For Your Information

- Precautions 27
- Troubleshooting Guide 27
- Maintenance 28
- Specifications 28
- Index to Parts and Controls 29

Index 31

Chapter 1: Setting Up

Connecting the Stereo

Inserting the Batteries

Setting the Clock

Connecting the Stereo

Use the illustrations below to connect your stereo.

If you want to connect any optional components to the stereo, see "Connecting Optional Equipment" in Chapter 6.

STEP 1 Connecting the Front Speakers

- 1 Twist the speaker cable coating and pull it from the end of the cable.



- 2 Connect the right speaker to SPEAKER R connectors and the left speaker to SPEAKER L connectors with the red cord to + and the black cord to -.

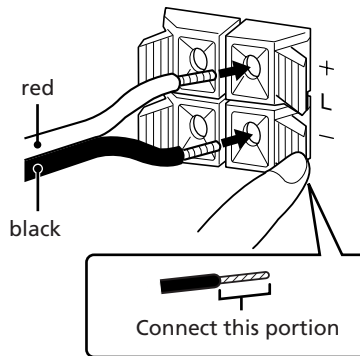

STEP 2 Connecting the Aerial

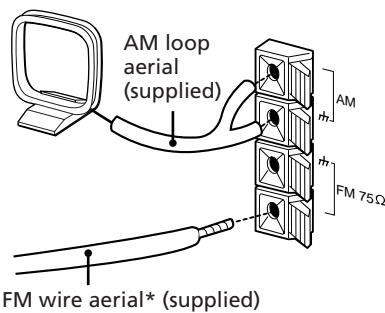

*Note: Extend it horizontally

To set up the AM loop aerial

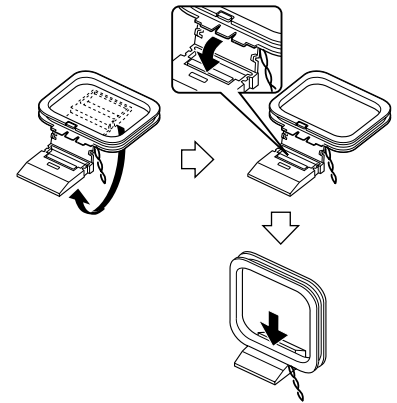

To improve the FM reception

Connect an outdoor FM aerial to the FM 75 Ω terminal, using a 75-ohm coaxial cable.

Important

Ground the external aerial from the terminal against lightning with the screw clamp. To prevent a gas explosion, do not connect the ground wire to a gas pipe.

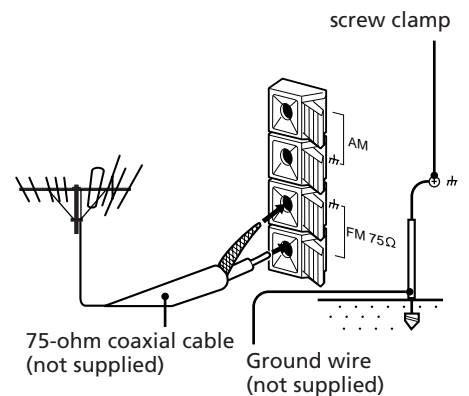

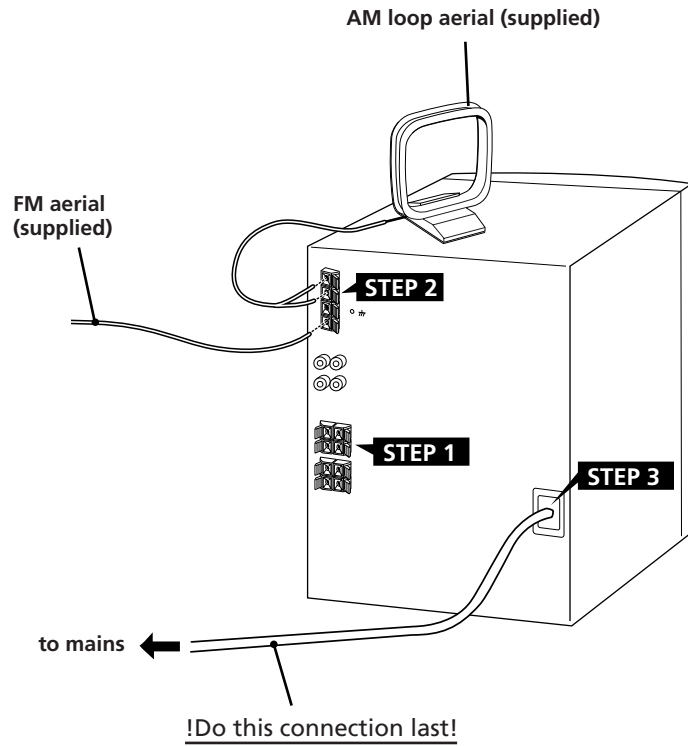

To improve the AM reception

After you connect the AM aerial, connect a 6- to 15- meter (20- to 50- feet) insulated wire to the AM terminal. Connect the *h* terminal to ground.

Important

Ground the external aerial from *h* terminal against lightning with the screw clamp. To prevent a gas explosion, do not connect the ground wire to a gas pipe.

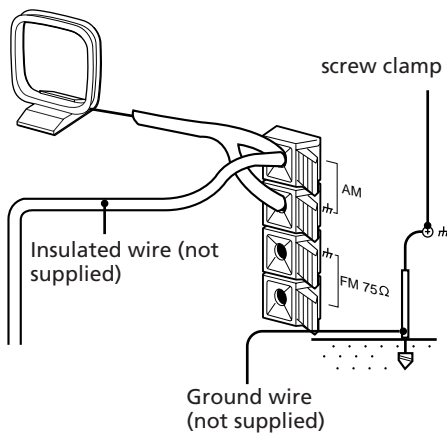

STEP 3 Connecting the Power

Connect the mains lead to a wall outlet after you have made all the above connections.

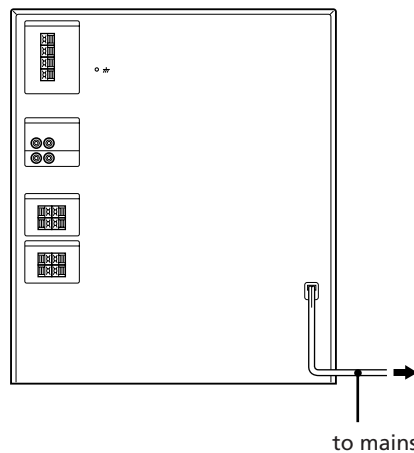

Demo mode

The demo mode appears in the display when you connect the mains lead to a wall outlet. To deactivate the demo mode, press DISPLAY/DEMO when the system power is off.

Note

When you turn on the system power for the first time, the disc tray starts rotating. You can operate the CD player after the disk tray stops rotating and "CD NO DISC" appears in the display.

Inserting the Batteries

Insert two size R6 (AA) batteries in the supplied remote for remote control.

- 1 Open the lid.

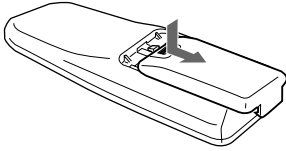

- 2 Insert two R6 (size AA) batteries. Match the + and - to the diagram in the battery compartment.

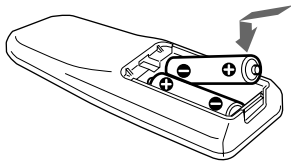

- 3 Close the lid.

Battery life

You can expect the remote to operate for about six months (using Sony SUM-3 (NS) batteries) before the batteries run down. When the batteries no longer operate the remote, replace all the batteries with new ones.

To avoid battery leakage

If you are not going to use the remote for a long time, remove the batteries to avoid damage caused by corrosion from battery leakage.

Setting the Clock

The built-in clock shows the time in the display.

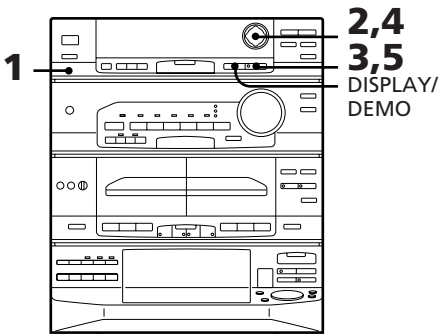

- 1 Press CLOCK SET. The "AM" and hour indication begin flashing.

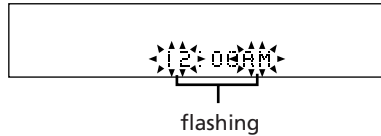

- 2 Set the current hour by pressing ◀ or ▶ (CURSOR CONTROL) until the correct hour appears.

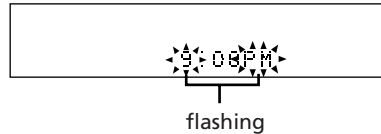

- 3 Press ENTER/NEXT. The minutes indication begins flashing.

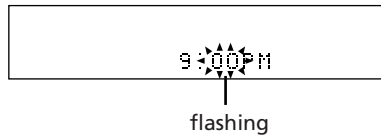

- 4 Set the current minute by pressing ◀ or ▶ until the correct minute appears.

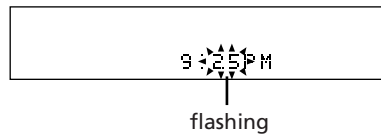

- 5 Press ENTER/NEXT. The clock starts running and the upper dot flashes. Use the time signal to set the clock accurately. The upper dot flashes for the first half of a minute (0 to 29 seconds), and the lower dot flashes for the last half of a minute (30 to 59 seconds).

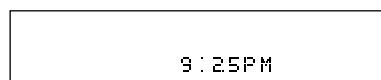

To check the time

Press DISPLAY/DEMO a few times. The current time appears for a few seconds.

To correct the clock setting

Repeat steps 1 to 5.

Chapter 2: the CD Player

Playing CDs (normal play)

Playing Tracks in Random Order (shuffle play)

Playing Tracks in the Desired Order (programme play)

Playing Tracks Repeatedly (repeat play)

Playing Tracks with Repeating a Specified Portion (loop play)

Grouping Tracks (music clip)

Playing CDs (normal play)

After you insert up to five CDs, you can play all tracks or discs in the original order consecutively (normal play).

You can also play them in four modes: normal, shuffle, programme or repeat. Before you play a CD, decrease the volume level by turning the VOLUME control anticlockwise, to prevent damage to the speakers.

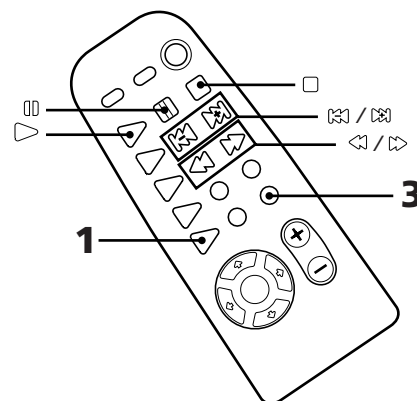
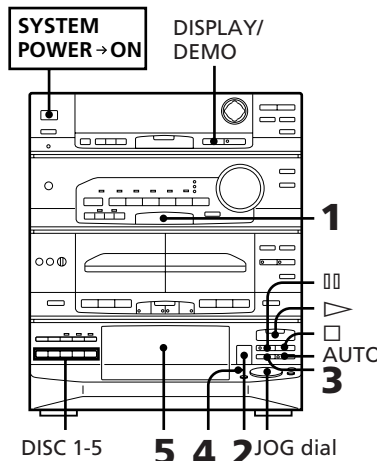

- 1 Press FUNCTION repeatedly until "CD" appears in the display. CD is selected.
- 2 Press OPEN and place a CD (label side facing up) on the disc tray in the loading position.

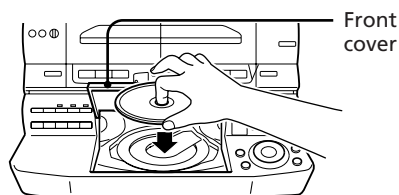

- 3 Press DISC SKIP to place up to four more CDs on the disc tray. The disc tray rotates so you can insert other CDs.

- 4 Press CONTINUE on the unit to choose whether to play "1 DISC" or "ALL DISCS".

Choose	To play
1 DISC	Only the CD you have selected.
ALL DISCS	All CDs consecutively in the order. Empty disc trays are skipped.



- 5 Close the front cover. Play starts automatically from the CD in the loading position. The disc number (of which color is orange) appears in the disc calendar.

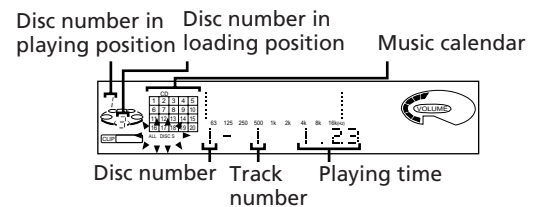

When AUTO indicator is not lit

Press CD (or CD on the remote) to play a CD.

To	Press
Stop play	□ (□ *1)
Pause	⏸ (⏸ *1)
Resume play	▶ or ⏸ (▶*1 or ⏸ *1)
Go forward to another track	During play or pause, turn the JOG dial clockwise*2. Or press AMS*3 (AMS) on the remote.
Go back to a previous track	During play or pause, turn the JOG dial anticlockwise*2. Or press AMS*3 (AMS) on the remote.
Select a particular CD	The corresponding DISC 1-5 button*4 or press DISC SKIP repeatedly
Remove or exchange a CD	OPEN*5

*1 Remote

*2 Turning the JOG dial quickly skips to the next CD.

*3 Auto Music Sensor

continue to next page →

→ **continued**

- *4 If there is no disc at that number, the disc tray rotates and plays the next CD. If there is no disc at that number with the front cover opened, the disc tray rotates to the loading position.
- *5 The disc tray rotates and brings the CD in the playing position to the loading position automatically when AUTO is selected (the AUTO indicator is lit).

To remove or exchange the CD in the loading position while playing.

Press \square OPEN and remove or exchange the loading position.

Note

After exchanging the CD in the loading position while playing, the CD in the loading position which you exchanged is the next CD to be played when AUTO is selected.

To play tracks consecutively (non-stop play)

Press and hold down CD \triangleright on the CD player for a second.

To cancel non-stop play

Press \square on the CD player.

Note

You cannot use this feature when the CD play mode is SHUFFLE or PROGRAM. Press CONTINUE so that "SHUFFLE" or "PROGRAM" disappears from the display.

To locate a particular point in a track

You can locate a particular point in a track while playing a CD. Use the buttons on the remote to operate this feature.

To locate a point	Press
While monitoring the sound	\triangleright (forward) or \triangleleft (backward) on the remote and keep pressing until you find the point.
Quickly by observing the display during pause	\triangleright (forward) or \triangleleft (backward) on the remote and keep pressing until you find the point. You will not hear the sound during this operation.

To check the remaining or total playing time

Press DISPLAY/DEMO repeatedly. Each time you press DISPLAY/DEMO while playing a CD, the display changes as follows:

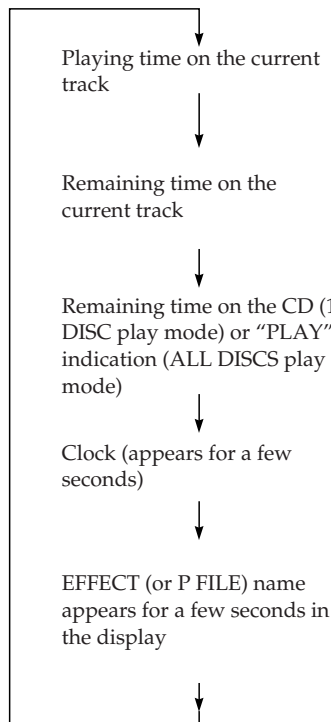

Note

- " - - - " appears in the display when the remaining time is 100 minutes or more.

When AUTO indicator is lit

- The CD in the loading position starts playing automatically when you close the front cover.
- The playing CD comes back to the loading position when you stop playing and open the front cover.
- When you exchange the CD while playing, the exchanged CD is the next CD to be played and the disc number keeps flashing.

If you don't want a CD to function as described above, press AUTO so that the AUTO indicator goes off.

One Touch Play feature

Press CD \triangleright (or CD \triangleright on the remote) when the power is off. You can listen to the last selected CD without pressing any other buttons when a CD is in the player. If you press CD \triangleright or DISC 1 - 5 while another source is selected, the CD player is selected and play starts automatically.

The music calendar display

This display lights according to the number of the tracks on the CD. As each track is played, the corresponding number disappears. Tracks numbering more than 20 are not displayed.

What the orange and red numbers in the disc calendar indicate

- The orange number in the disc calendar indicates the disc number in the playing position. When the CD player is not playing and the AUTO indicator is not lit, the CD whose disc number is orange is the next CD to be played.
- The red number in the disc calendar indicates the disc number in the loading position. You can remove the CD whose disc number is red while playing.

Playing Tracks in Random Order (shuffle play)

You can play all the tracks on a CD or all CDs in random order.

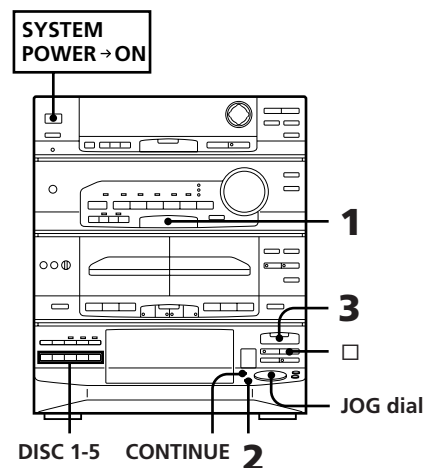

- 1 Press FUNCTION repeatedly until "CD" appears in the display.
- 2 Press SHUFFLE to choose whether to play "1 DISC" or "ALL DISCS". "ALL DISCS SHUFFLE" or "1 DISC SHUFFLE" appears in the display.



- 3 Press CD \triangleright (or CD \triangleright on the remote). " \square " appears and then all the tracks play in random order. To skip to the next track, turn the JOG dial clockwise on the CD player (or press \triangleright on the remote). To replay the current track, turn the JOG dial anticlockwise on the CD player (or press \triangleleft on the remote). You cannot replay the previous track.

To stop playing

Press \square (or \square on the remote).

To cancel shuffle play

Press CONTINUE on the unit.

To select the desired CD

Press DISC 1 – 5 on the unit during "1 DISC SHUFFLE" play.

Playing Tracks in the Desired Order (programme play)

You can programme up to 32 tracks from all the CDs in the order you want them to be played.

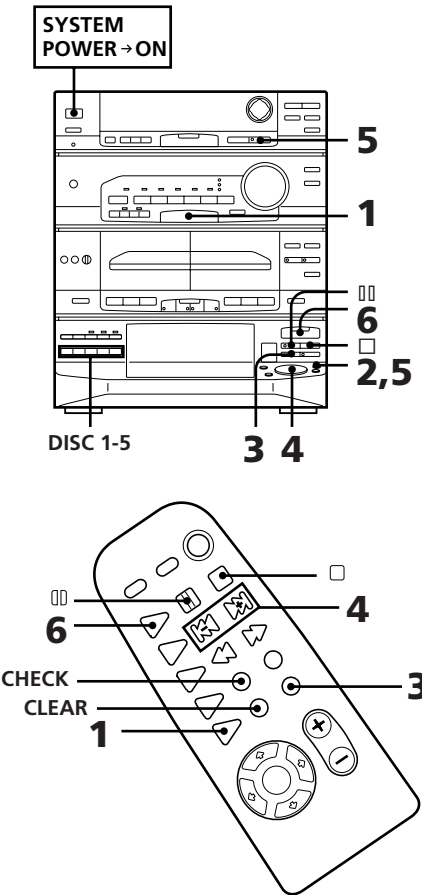

1 Press FUNCTION repeatedly until "CD" appears in the display.

2 Press PROGRAM. "PROGRAM" appears in the display.



3 Press DISC SKIP repeatedly (or DISC 1 – 5) to choose a CD.

4 Turn the JOG dial (or press \odot / \odot on the remote) to choose a track. The chosen track number appears and the playing time flashes for about 15 seconds in the display.

5 Press PROGRAM or ENTER/NEXT. The chosen track is programmed and its number lights up in the music calendar. If the track number disappears before you press PROGRAM or ENTER/NEXT, go back to step 3.

To programme additional tracks from the same CD, repeat steps 4 and 5.

To programme additional tracks from another CD, repeat steps 3 to 5.

Note

- If " - - - " appears instead of the total playing time, this means
 - you have programmed a track number which exceeds 20.
 - the total time has exceeded 100 minutes.

6 Press CD \triangleright (or CD \triangleright on the remote). All the tracks play in the order you choose.

To	Press
Check the programme	CHECK on the remote repeatedly*1
Programme a pause	\parallel *2 (\parallel on the remote)
Stop play	\square (\square on the remote)
Cancel the programme play	CONTINUE*3
Erase a track from the end	CLEAR on the remote in stop mode
Erase a specific track	CHECK on the remote repeatedly so the number of the track lights up, and press CLEAR on the remote
Erase a entire programme	\square (\square on the remote) once in stop mode or twice while playing

*1 After the last track appears, "CHECK END" appears in the display.

*2 "P" appears in the display and the total playing time is reset to 0.00.

*3 The programme is erased.

To change the order of programmed tracks

Erase the entire programme and create a new one.

The whole programme is erased also when:

- you select another play mode.
- you change or remove the CDs.

Playing Tracks Repeatedly (repeat play)

The repeat play function repeats a single CD or all CDs in normal, programme, and shuffle play.

In normal play mode only, the player can also repeat a single track.

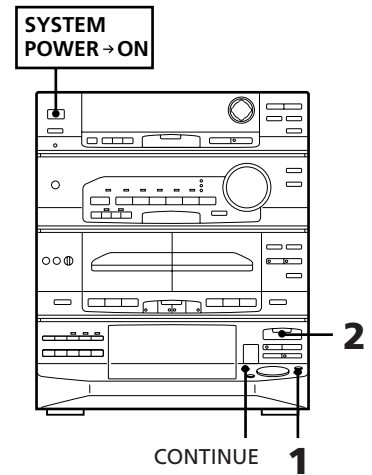

Repeating all the tracks

1 Press REPEAT once so that "REPEAT" lights up in the display.



2 Press CD \triangleright (or CD \triangleright on the remote).

continue to next page \rightarrow

→ continued

To	Press
Repeat all the tracks on the current CD	CONTINUE repeatedly until "1 DISC" appears in the display.
Repeat all the tracks on all CDs	CONTINUE repeatedly until "ALL DISCS" appears in the display.
Repeat only one track (in normal play only)	REPEAT repeatedly until "REPEAT 1" appears in the display while playing the track you want to repeat.

To cancel repeat play

Press REPEAT so that "REPEAT" or "REPEAT 1" disappears from the display.

Playing Tracks with Repeating a Specified Portion (loop play)

You can make a sampler sound effect by playing a short portion of the track repeatedly (loop play). It is useful for making original dance music style tapes.

Original music :

Hey, Come on Everybody!

When you make the effect :

Hey, Co Co Co Co Come on Everybody!

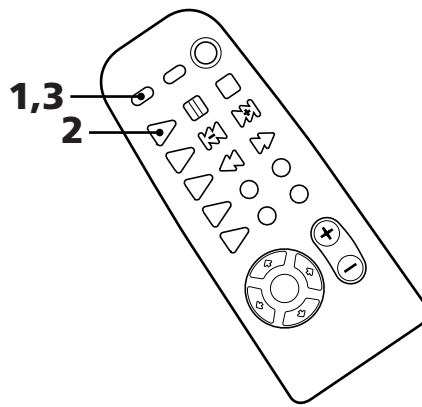
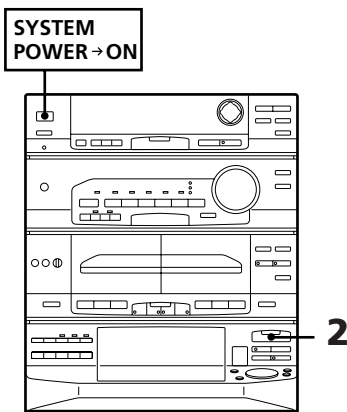

- 1 Press the LOOP button on the remote. You can choose the repeating time from about 0.25 sec. to about 1 sec. for NORMAL 1 – 5 and RHYTHM 1 – 5. For more information on NORMAL and RHYTHM, see "What is the difference between NORMAL and RHYTHM ?" for details.

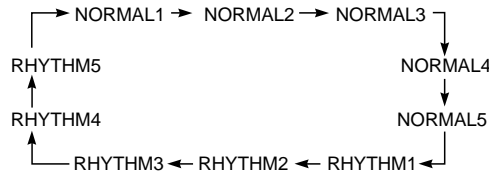

You can get the longest repeating time by selecting NORMAL (RHYTHM) 5, and the shortest with NORMAL (RHYTHM) 1.

- 2 Press CD ▷ (or CD ▷ on the remote). The CD player starts playing.
- 3 Press and hold down the LOOP button when the portion you want to record is heard.

What is the difference between NORMAL and RHYTHM?

The NORMAL differs from RHYTHM in respect to the restarting point of the music when the loop effect ends in step 3. Select the repeating time while the CD player is in pause or stop mode.

When you play the loop for five seconds.

NORMAL

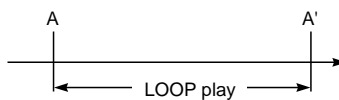

In this case, the song restarts at the point that you started the loop (A).

RHYTHM

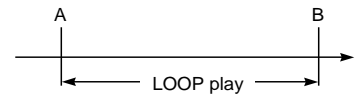

In this case, the song restarts at the point 5 sec. after you started the loop (B).

Group Tracks (music clip)

The music clip function is an easy way to create up to 3 arbitrary groups of tracks from your CDs. For example, you could store tracks for the morning in CLIP A, tracks to play for your friends in CLIP B, and tracks for relaxing in CLIP C. Once you store one or more tracks in a music clip(s), the player recalls those tracks whenever you play the respective disc.

Storing tracks in a clip

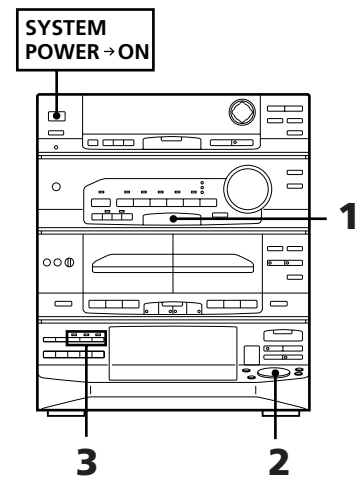

- 1 Press FUNCTION repeatedly until "CD" appears in the display.
- 2 Play the track you want to store by turning the JOG dial to select the track you want.
- 3 Press a CLIP button (A, B or C). "CLIP FILE" appears and indicator of CLIP you stored lights up in the display. Normal playback continues.



- Repeat steps 2 and 3 to store other tracks into the same, or a different clip.

If the memory becomes full

Each clip can hold memory tracks from 10 different CDs even if you have removed or exchanged CDs.

The clip data for the oldest clip is erased to make room for a new clip.

Note

- In stop mode, music clips cannot store tracks when "SHUFFLE" or "PROGRAM" is lit in the display.
- Only tracks numbered 1 - 20 on the disc can be stored in music clips. The tracks numbered 21 or more cannot be stored.

Playing tracks in a clip (clip play)

Clip indicators (A, B or C) light in the display to let you know when clips are stored for a disc.

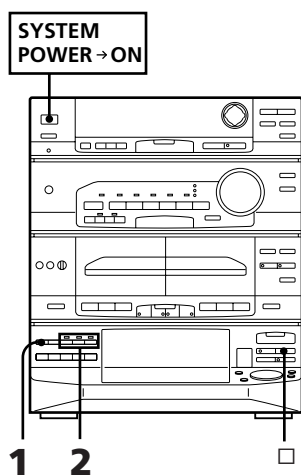

- Press MUSIC CLIP PLAY. "SELECT A - C" and "PLAY A - C" appears in the display alternately.
- Press a CLIP button (A, B, or C). "CLIP PLAY" appears in the display and the selected CLIP indicator lights up. The player starts playing tracks from the selected CLIP. You can see the tracks in CLIP with music calendar.

To cancel clip play

Press on the CD player.

Note

- In 1 DISC mode, the tracks stored for the selected disc are played back once, then clip play is released.
- In ALL DISCS mode, all the tracks stored for the currently loaded discs are played back once, then clip play is released.
- You cannot start CLIP play if "PROGRAM" is displayed.

Erasing tracks from a clip

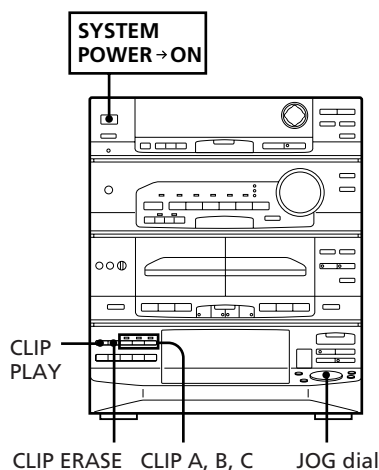

Erasing a track

- Press CLIP PLAY.
- Press the CLIP button (A, B, or C) for the clip containing the tracks you want to erase.
- Use the JOG dial to select the track you want to erase.
- Press CLIP ERASE while the track you want to erase is being played. "ERASE A - C" and "TRACK A - C" appear alternately in the display and the selected CLIP indicator flashes.
- Press CLIP button while the indicator is flashing. The play stops and the selected track is erased.

Erasing all the tracks in a CLIP A (B or C)

- In stop mode, press CLIP ERASE. "ERASE A - C" and "ALL A - C" appear alternately in the display and all CLIP indicators flash.
- Press a CLIP button (A, B, or C) to specify the clip you want to erase. "PUSH" and the selected CLIP (A, B or C) appears in the display.
- Press the CLIP button you have pressed on step 2 again.

Note

You cannot erase tracks if a CD includes the tracks you stored, is not in playing position.

Chapter 3: the Radio

Listening to the Radio

Presetting Radio Stations

Playing Preset Radio Stations

Listening to the Radio

When you want to play a radio programme, you can have the tuner automatically scan the radio frequencies and tune in the stations with clear signals. This feature saves you time in searching for stations with clear signals.

However, stations with weak signals may be skipped by automatic tuning. Manually tune in stations with weak signals.

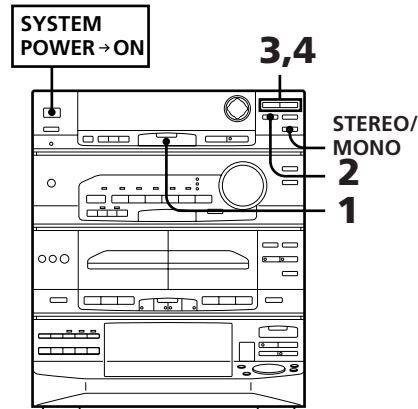

- 1 Press TUNER/BAND repeatedly until the band you want appears and in the display. As you press this button, the band changes as follows:

FM ↔ AM



- 2 Press TUNING MODE repeatedly until "AUTO" appears in the display.

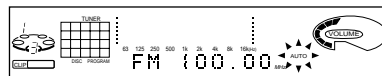

- 3 Press TUNING +/- buttons (or on the remote). The tuner starts scanning radio frequencies, and stops when it finds a clear station. "TUNED" appears in the display. "STEREO" also appears if the FM station tuned in is broadcasting in stereo.

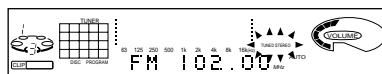

- 4 If you don't want to listen to the selected station, press TUNING +/- (or on the remote) buttons to restart the scan.

When the desired station is not tuned in

Automatic tuning may skip the stations with weak signals and continue scanning without a stop. In this case, tune in the station manually.

- 1 Press TUNING MODE repeatedly until "MANUAL" appears in the display.
- 2 Press TUNING +/- buttons repeatedly until the desired station is tuned in.

To improve MW (AM) broadcast reception

Reorient the supplied AM loop aerial for MW (AM).



To change the AM tuning interval

The AM tuning interval is preset to 9 kHz (10 kHz in some areas) at the factory. If you need to change the interval, do as follows:

- 1 Turn on the power.
- 2 Change the band to AM.
- 3 Turn off the power.
- 4 Turn the power back on while pressing ENTER/NEXT.

After changing the AM tuning interval, reset the preset AM radio stations. To reset the interval to the factory setting, follow the same procedure.

When an FM programme is not received clearly

Press STEREO/MONO on the unit so that "MONO" appears in the display. There will be no stereo effect, but the reception will improve. Press STEREO/MONO again to restore the stereo effect.

One Touch Play feature

Press TUNER/BAND (or TUNER/BAND on the remote) when the power is off or when you are listening to another sound source.

You can listen to the last received station without pressing any other buttons.

Note

When you listen to a sound source other than the tuner, you can select the tuner by pressing TUNER/BAND (Automatic Source Selection).

Presetting Radio Stations

You can store radio frequencies in the tuner's memory to tune in your favourite stations quickly. You can preset up to 20 FM stations and 10 AM stations in any order.

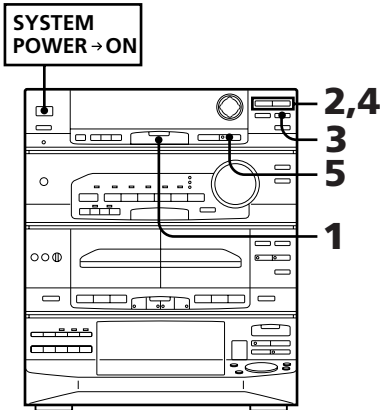

- 1 Press TUNER/BAND repeatedly until the band you want appears in the display.

FM ↔ AM



- 2 Press TUNING +/- buttons to tune in the station you want to store.

- 3 Press TUNER MEMORY. "MEMORY" appears and the preset channel number flashes in the display.

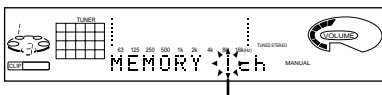

Preset channel number

- 4 Press TUNING +/- buttons to display the preset channel number you want.

- 5 Press ENTER/NEXT. "MEMORY" disappears, and the station is stored at the preset channel number you decided on.

Preset channel number

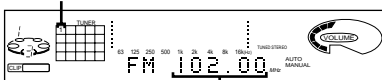

Tuned station frequency

- 6 Repeat steps 1 to 5 for each station you want to store.

To erase a stored station

Store a new station at a previously used preset station number. It will erase the old station and replace it with the new station.

If you have trouble storing a station

Make sure "MEMORY" is lit in the display. If not, press TUNER MEMORY again so that "MEMORY" appears (for about eight seconds) in the display, and then proceed with steps 4 and 5.

- 2 Press TUNING MODE repeatedly so that "PRESET" appears in the display.



- 3 Press TUNING +/- buttons (or [TUNING] / [PRESET] on the remote) to tune in a preset station.

The station frequency appears and the system begins receiving the stations.

Preset channel number

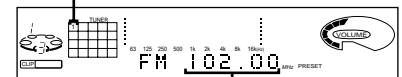

Station frequency

Playing Preset Radio Stations

Once you have preset the stations, use the TUNING +/- buttons (or [TUNING] and [PRESET] on the remote) to quickly tune in your favourite stations.

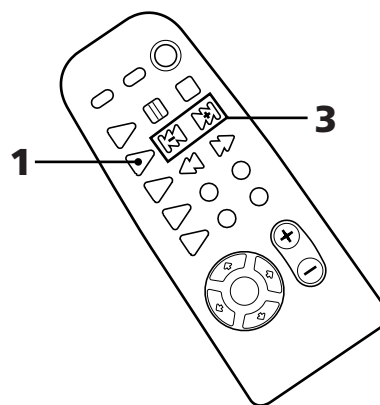
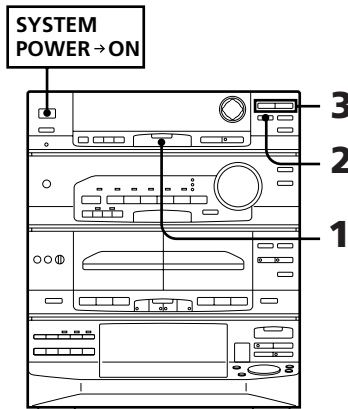

- 1 Press TUNER/BAND (or TUNER/BAND [TUNING] on the remote) repeatedly until the band you want appears in the display.

FM ↔ AM

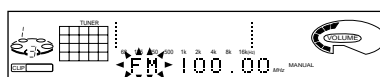

Chapter 4: the Tape Player

Playing a Tape

Recording a CD

Recording a CD: Selecting Tape Length (tape select edit)

Recording a CD: Specifying Tape Length (time edit)

Recording a CD: Specifying Track Order (programme edit)

Recording From the Radio

Recording From Another Tape (dubbing)

Playing a Tape

You can use TYPE I (normal) and TYPE II (CrO₂) tapes. When you insert a tape, the deck detects the tape type automatically.

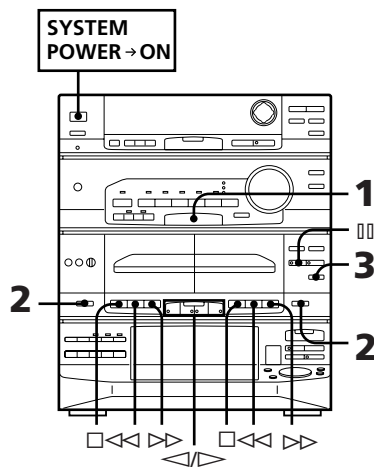

- 1 Press FUNCTION repeatedly until "TAPE" appears in the display. TAPE is selected.
- 2 Press EJECT to open the tape compartment. Insert a recorded tape in deck A or B with the tape side facing down and the side you want to play facing forward. Push to close the compartment. The tape will start playing from the front side.

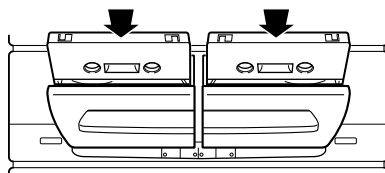

- 3 Press DIRECTION to choose single-side, dual-side, or relay play. The DIRECTION setting affects both decks.

To play	Press DIRECTION to select
One side of the tape	\rightleftarrows
Both sides*	\rightleftarrows
Both decks in succession**	RELAY

* The deck stop automatically after repeating the sequence five times.

**See "To play both decks in succession (relay play)".

- 4 Press \triangleright (to play the front side) or \triangleleft (to play the reverse side). The tape starts playing.

To	Press
Stop play	\square
Pause (DECK B only)	\parallel
Resume play after pause	\parallel or \triangleleft or \triangleright
Fast forward	$\triangleright\triangleright$ for front side $\triangleleft\triangleleft$ for reverse side
Rewind	$\triangleleft\triangleleft$ for front side $\triangleright\triangleright$ for reverse side
Remove the cassette	EJECT

To control the remote

- 1 Press DECK A \triangleright or DECK B \triangleright to play the front side and press DECK \triangleright or DECK B \triangleright again to play the reverse.
- 2 Press the desired operation button.

To play both decks in succession (relay play)

Relay play is according to the following sequence. When the reverse side of the tape in deck B finishes playing, the sequence continues four more times.

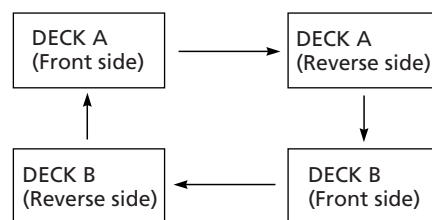

- 1 Press EJECT and insert recorded tapes in both decks.
- 2 Press DIRECTION repeatedly until "RELAY" appears in the display.
- 3 Press \triangleleft or \triangleright on either deck. To stop relay play, press \square .

To cancel relay

Press DIRECTION repeatedly until " \rightleftarrows " or " \rightleftarrows " appears in the display.

One Touch Play feature

Press \triangleleft or \triangleright (or DECK A \triangleright / DECK B \triangleright on the remote) when the power is off. When a tape is in the player, you will immediately be able to listen to the tape without pressing any other buttons. If no tape is inserted, the system will just turn on. The TAPE player always starts playing from the front side of the tape when you operate the remote.

Recording a CD

You can record from a CD to a tape. Use TYPE I (normal) or TYPE II (CrO₂) tapes. You can not listen to other sources while recording.

Recording a CD automatically

By using CD SYNCHRO, you can record from a CD to a tape easily. Use the buttons on the unit for this operation.

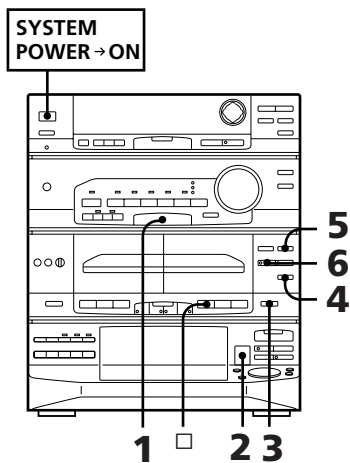

- 1 Press FUNCTION repeatedly until "CD" appears in the display.
- 2 Press OPEN and place a CD on the tray. Make sure the disc number in the playing position in the display is the one you want to record. The total number of tracks and the playing time appear in the display.
- 3 Press EJECT and insert a blank tape into deck B with the side you want to record on facing forward. Recording starts from the front side of the tape, unless you change the playing direction before recording. Make sure the tabs on the cassette have not been removed.
- 4 Select dual or single-sided recording.

To record	Press DIRECTION to select
One side of the tape	→
Both sides*	↔ or RELAY

* Recording always stops at the end of the reverse side. Be sure to start from the front side.

- 5 Press CD SYNCHRO. The REC and PAUSE lamps light up and deck B stands by for recording.

The ▷ lamp lights up and the ◁ lamp flashes for a few seconds, then disappears.

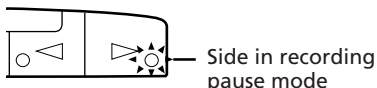

If you want to start recording from the reverse side, press ◁ so that the ◁ lamp lights steadily.

- 6 Press PAUSE to release recording pause. Recording starts. After about 10 seconds, the CD starts playing.

To stop recording

Press STOP on the tape player.

To record with surround effect

Press SURROUND so that "SUR (|||||)" appears in the display. The equalizer you have adjusted will not be recorded.

Recording a CD Manually

You can record a CD as you like, for example, record just the songs you want or record from the middle of the tape.

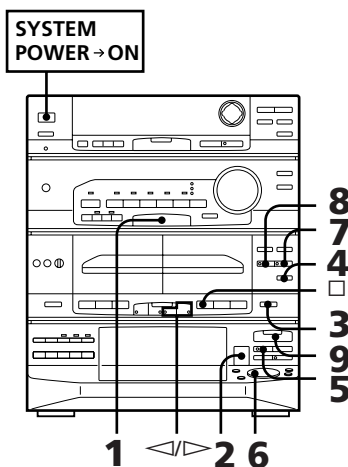

- 1 Press FUNCTION repeatedly until "CD" appears in the display.
- 2 Press OPEN and place a CD on the tray. Make sure the disc number in the playing position in the display is the one you want to record. The total number of tracks and the playing time appear in the display.
- 3 Press EJECT and insert a blank tape into deck B with the side you want to record on facing forward.

Recording starts from the front side of the tape, unless you change the playing direction before recording. Make sure the tabs on the cassette have not been removed.

- 4 Select dual or single-sided recording.

To record	Set DIRECTION to
One side of the tape	→
Both sides*	↔ or RELAY

* Recording always stops at the end of the reverse side. Be sure to start from the front side.

- 5 If you want to record a specific track of the CD, press JOG on the CD player. The CD player pauses for playing. If you do not need to choose a track, skip to step 7.

- 6 Turn the JOG dial to choose the track you want to record.

- 7 Press REC.

The REC and PAUSE lamps light up and deck B stands by for recording. The ▷ lamp lights up and the ◁ lamp flashes for a few seconds, then disappears.



If you want to start recording from the reverse side, press ◁ so that the ◁ lamp lights steadily.

- 8 Press PAUSE to release recording pause. Recording starts.
- 9 Press CD ▷. The CD player starts playing.

To	Press
Stop recording	STOP
Pause recording	PAUSE

To record with the surround effect

Press SURROUND so that "SUR (|||||)" appears in the display. The equalizer you have adjusted will not be recorded.

Note

If you want to record specific tracks of the CD, the "programme edit" feature will make it easier.

Recording a CD: Selecting Tape Length (tape select edit)

You can have the stereo system select and indicate the most suitable tape length for recording each disc automatically. You cannot use tape select edit for discs which contain 21 tracks or more.

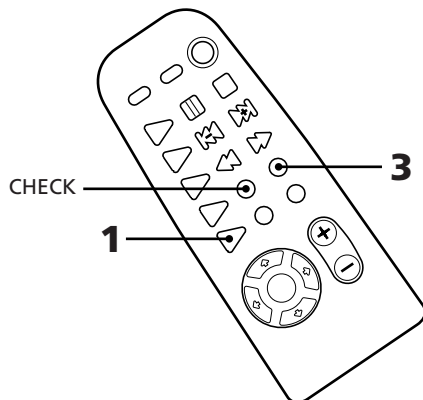
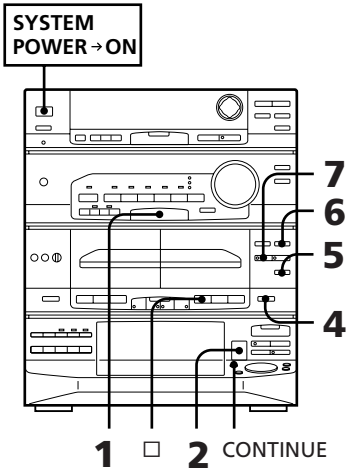

- 1 Press FUNCTION repeatedly until "CD" appears in the display.
- 2 Press \square OPEN and place a CD on the tray. Make sure the disc number in the playing position in the display is the one you want to record. The total number of tracks and the playing time appear in the display.

- 3 Press EDIT on the remote. "TAPE SELECT" appears in the display and the player divides the selections automatically. Then the display changes as follows:

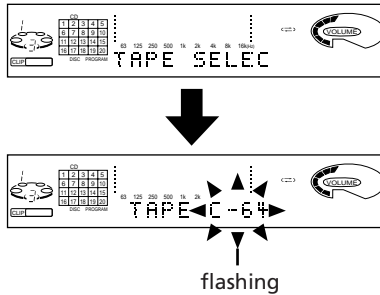

- 4 Press \square EJECT and insert a blank tape of the indicated length (or longer) into deck B with the side you want to record on facing forward. Make sure the tabs on the cassette have not been removed.

- 5 Select dual or single-sided recording.

To record	Press DIRECTION to select
One side of the tape	\rightleftarrows
Both sides*	\leftrightarrow or RELAY

* Recording always stops at the end of the reverse side. Be sure to start from the front side.

- 6 Press CD SYNCHRO. The REC and \square (pause) lamps light up and deck B stands by for recording. The \triangleright lamp lights up and the \triangleleft lamp flashes for a few seconds, then disappears.

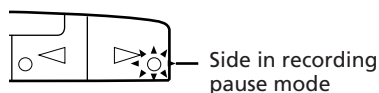

If you want to start recording from the reverse side, press \triangleleft so that the \triangleleft indicator lights steadily.

- 7 Press \square on the tape player to release recording pause. Recording starts. After about 10 seconds, the CD player starts playing.

To stop recording
Press \square on the tape player.

To check the order
Press CHECK on the remote.

To cancel tape select edit
Press CONTINUE on the unit.

Recording a CD: Specifying Tape Length (time edit)

You can have the stereo system create programmes based on the tape length. The CD player makes programmes that will fit the tape length. For example, if you use a 46-minute tape to record a 50-minute CD, the CD player will automatically choose tracks that will fit within the 46-minutes, filling as much of the tape as possible. The player will not programme those tracks beyond track number 20.

Use the buttons on both the unit and the remote to do this operation.

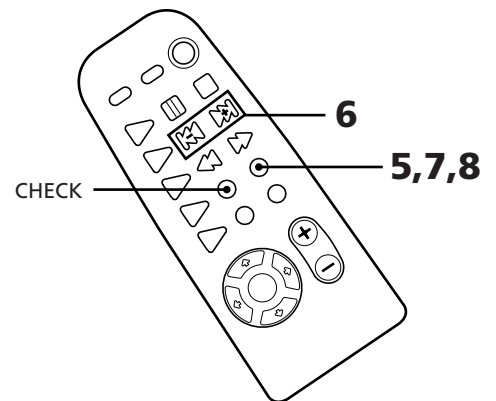
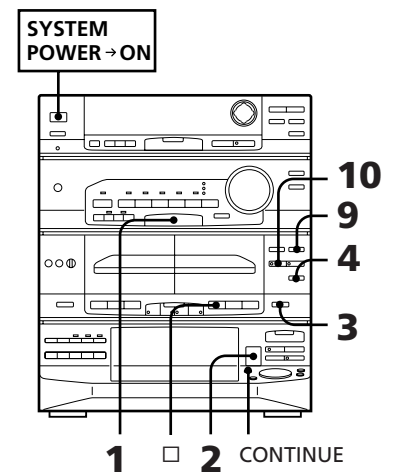

- 1 Press FUNCTION repeatedly until "CD" appears in the display.
- 2 Press \square OPEN and place a CD on the tray. Make sure the disc number in the playing position in the display is the one you want to record. The total number of tracks and the playing time appear in the display.

3 Press EJECT and insert a blank tape into deck B with the side you want to record on facing forward. Recording starts from the front side of the tape, unless you change the playing direction before recording. Make sure the tabs on the cassette have not been removed.

4 Select dual or single-sided recording.

To record	Press DIRECTION to select
One side of the tape	\leftarrow
Both sides*	\leftrightarrow or RELAY

* Recording always stops at the end of the reverse side. Be sure to start from the front side.

5 Press EDIT twice. "TIME EDIT" appears then "SELECT" and "TIME" appear alternately in the display.

6 Press HALF / RELAY on the remote to designate the tape length or "HALF". As you press the button, the display changes as follows:

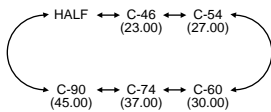

Choose "HALF" if you want the CD player to half of the total playing time of the CD in original order. You cannot select "HALF" when recording CDs with more than 20 tracks. "PUSH EDIT" and half of the total time of the tape you selected appears in the display.

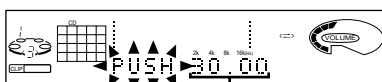

Half of the total time of the tape

7 Press EDIT. The CD player determines the tracks to be recorded on side A automatically. Total time and tracks to be recorded on side A appears in the display.

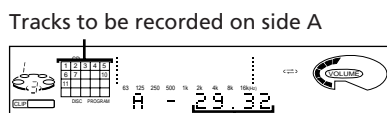

Total playing time on side A

8 When you want to record on both sides, press EDIT again. The CD player determines the tracks to be recorded on side B.

Tracks to be recorded on both sides

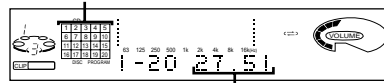

Total playing time on side B

9 Press CD SYNCHRO. The REC and PAUSE lamps light up and deck B stands by for recording. The PLAY lamp lights up and the STOP lamp flashes for a few seconds, then disappears.

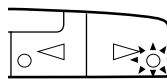

Side in recording pause mode

If you want to start recording from the reverse side, press REVERSE so that the REVERSE indicator lights steadily.

10 Press STOP on the tape player to release recording pause. Recording starts. After about 10 seconds, the CD player starts playing.

To stop recording

Press STOP on the tape player.

To cancel time edit

Press CONTINUE on the unit.

To check the order

Press CHECK on the remote repeatedly. Each time you press CHECK, the number of the programmed tracks appear in the display.

To select the desired tracks beforehand

You can record certain tracks (up to 20) first by selecting them before time editing. See "Playing Tracks in the Desired Order (programme play)".

Recording a CD: Specifying Track Order (programme edit)

You can adjust the total recording time to the tape length while making a programme.

SYSTEM POWER \rightarrow ON

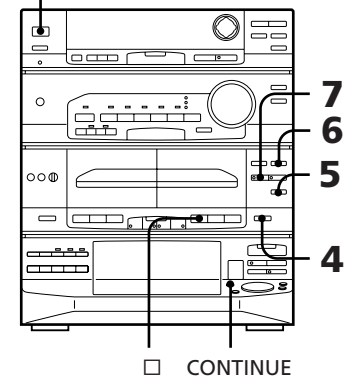

\square CONTINUE

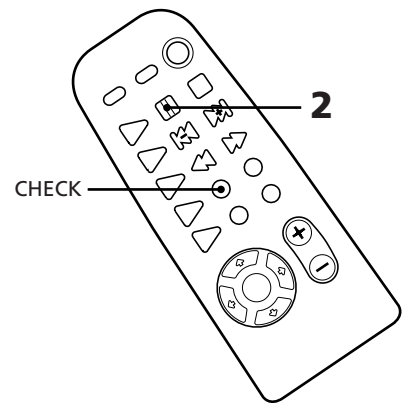

- Following the procedure "Playing Tracks in the Desired Order (programme play)", programme the tracks you want to record for side A. Make sure to programme the tracks so that the total playing time of the side A does not exceed the tape length of one side.
- Press STOP on the remote to pause recording at the end of the side A. "P" appears in the display. The total playing time "0.00" is displayed.
- Programme the tracks you want to record for side B in the same way as you did for side A.
- Press EJECT and insert a blank tape into deck B with the side you want to record on facing forward. Recording will start from the front side of the tape, unless you have changed the playing direction before recording. Make sure the tabs on the cassette have not been removed.

continue to next page \rightarrow

continued →

5 Select dual or single-sided recording.

To record	Press DIRECTION to select
One side of the tape	→
Both sides*	↔ or RELAY

* Recording always stops at the end of the reverse side. Be sure to start from recording pause.

6 Press CD SYNCHRO.
The REC and ⏸ (pause) lamps light up and deck B stands by for recording. The ▷ lamp lights up and the ◁ lamp flashes for a few seconds, then disappears.

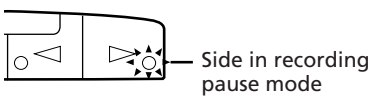

If you want to start recording from the reverse side, press ◁ so that the ◁ indicator lights steadily.

7 Press ⏸ on the tape player to release recording pause.
Recording starts.
After 10 seconds, the CD player starts playing.

To stop recording
Press □ on the tape player.

To check the order
Press CHECK repeatedly.
Each time you press CHECK, the number of the programmed tracks appear in the display.

To cancel programme edit
Press CONTINUE.

Recording From the Radio

You can record from the tuner onto a tape. Use TYPE I (normal) or TYPE II (CrO₂) tape.

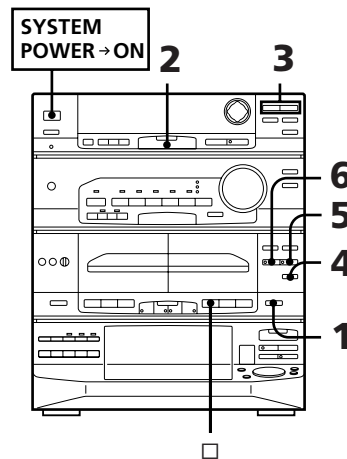

1 Press ⏏ EJECT and insert a blank tape into deck B with the side you want to record on facing forward.
Recording starts from the front side of the tape, unless you change the playing direction before recording. Make sure the tabs on the cassette have not been removed.

2 Press TUNER/BAND several times until the desired radio band appears.

3 Tune in the radio station you want to record. (See "Listening to the Radio", or "Playing Preset Radio Stations" for details.)

4 Select dual or single-sided recording.

To record	Press DIRECTION to select
One side of the tape	→
Both sides*	↔ or RELAY

* Recording always stops at the end of the reverse side. Be sure to start from the front side.

5 Press REC.
The REC and ⏸ (pause) lamps light up and deck B stands by for recording. The ▷ lamp lights and the ◁ lamp flashes for a few seconds, then disappears.

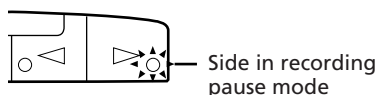

If you want to start recording from the reverse side, press ◁ so that the ◁ indicator lights steadily.

6 Press ⏸ on the tape player to release recording pause.
Recording starts.

To stop recording
Press □ on the tape player.

To reduce noise during MW/SW (AM) recording

If a whistling noise is heard while recording, reorient the AM loop aerial for optimum reception.

Recording From Another Tape (dubbing)

Dubbing Another Tape Automatically

You can record an entire tape onto another automatically by using high speed dubbing. Use the buttons on the unit and TYPE I (normal) or TYPE II (CrO₂) tape for dubbing.

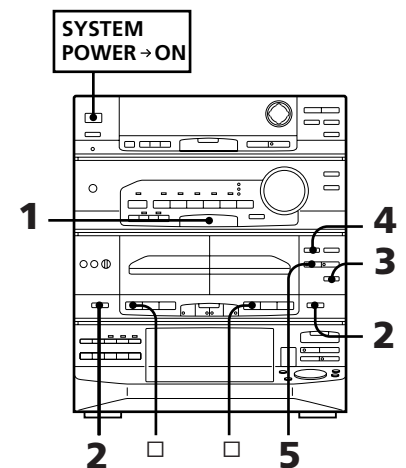

1 Press FUNCTION repeatedly until "TAPE" appears in the display. TAPE is selected.

2 Press ⏏ EJECT and insert a recorded tape in deck A with the side you want to play facing forward. Also, insert a blank tape in deck B with the side you want to record on facing forward.
Recording and playback will start from the front side of the tape, unless you change the playing direction before recording. Make sure the tabs on the cassette in deck B have not been removed.

3 Choose how you want the tape to record and press DIRECTION repeatedly until the desired mode appears.

Position	Operation
⇌	Dubbing stops at the end of one side
↔	When the tape in one deck comes to the end of the front side, it reverses immediately regardless of the tape position in other deck.
RELAY	When the tape in one deck reaches its end of the front side, it stops until the other tape come to its end, and then both tapes reverse together.

- 4** Press HIGH SPEED DUBBING. The REC and ⏸ (pause) lamps light and deck B stands by for recording. The ▷ lamp lights and the ◁ lamp flashes for a few seconds, then disappears.

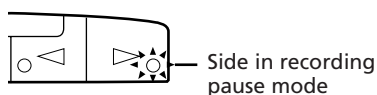

If you want to start recording from the reverse side, press ◁ so that the ◁ indicator lights steadily.

- 5** Press ⏸ on the tape player. The tape player starts dubbing at high speed. If you set DIRECTION to ↔ or RELAY, recording always stops at the end of the reverse side.

To stop dubbing

Press □ on DECK A or DECK B.

If you select another sound source while dubbing

Dubbing stops.

Dubbing Another Tape Manually

When you want to dub only part of the tape, dub manually at normal speed. Use the buttons on the unit and TYPE I (normal) or TYPE II (CrO₂) tape for recording.

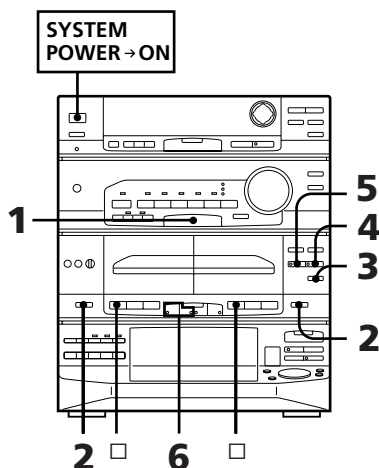

- 1** Press FUNCTION repeatedly until "TAPE" appears in the display. TAPE is selected.
- 2** Press ⏏ EJECT and insert a recorded tape in deck A with the side you want to play facing forward. Also, insert a blank tape in deck B with the side you want to record on facing forward. Recording and playing will start from the front side of the tape, unless you have changed the playing direction before recording. Make sure the tabs on the cassette in deck B have not been removed.
- 3** Select dual or single-sided recording.

To dub	Set DIRECTION to
One side of the tape	⇌
Both sides*	↔ or RELAY

* Recording always stops at the edge of the end of the reverse side. Be sure to start from the front side.

- 4** Press REC. The REC and ⏸ (pause) lamps light up and deck B stands by for recording. The ▷ lamp lights and the ◁ lamp flashes for a few seconds, then disappears.

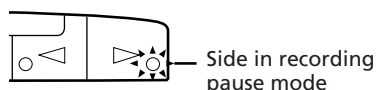

If you want to start recording from the reverse side, press ▷ so that the ◁ lamp lights steadily.

- 5** Press ⏸ on the tape player to release recording pause on deck B. Recording starts on deck B. If you set DIRECTION to ↔ or RELAY, recording always stops at the end of the reverse side.

- 6** Press ◁ or ▷. The tape on deck A starts playing.

To stop dubbing

Press □ on DECK A or DECK B.

Note

Do not use the microphone while dubbing.

Chapter 5: Sound Adjustment

Adjusting the Sound

Selecting the Audio Emphasis

Adjusting the Audio Emphasis

Making Your Personal Audio Emphasis File (personal file)

Adjusting the Sound

To fully enjoy the sound coming from your stereo system, make the following audio adjustments. See the sections following this one for additional sound adjustments.

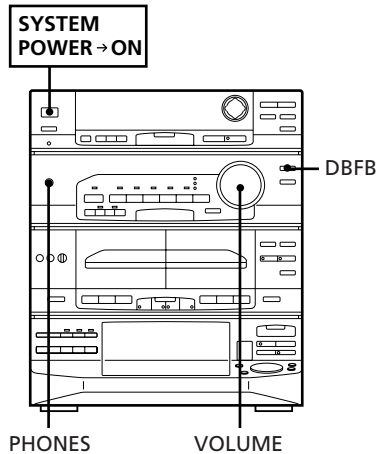

To adjust the volume

Turn the VOLUME on the unit clockwise/anticlockwise to increase or decrease the sound, or press VOL (+/-) on the remote.

To reinforce bass

Press DBFB* repeatedly and choose DBFB or DBFB .

"DBFB " is stronger than "DBFB ".

* DBFB = Dynamic Bass Feedback

To listen through the headphones

Connect the headphones to the PHONES jack. No sound will come from the speakers.

Selecting the Audio Emphasis

Your stereo system has been factory set to five specially recommended audio emphasis settings. Choose from among these five preset settings according to the type of music you are listening to.

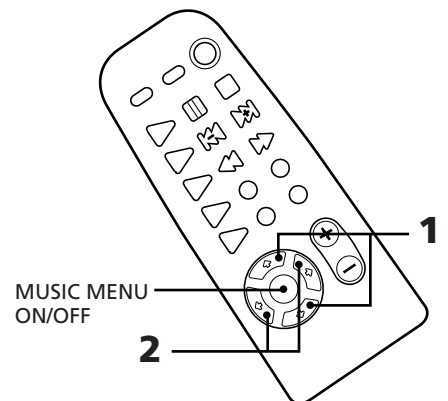
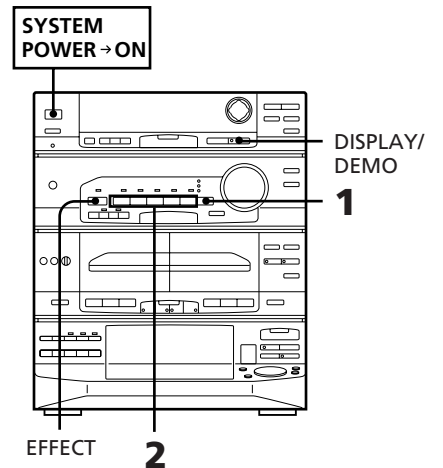

1 Press FILE SELECT (or MUSIC MENU on the remote) to select SELECT 5. The SELECT 5 indicator lights up.

2 Press one of the FILE 1 – 5 buttons on the unit (or MUSIC MENU on the remote). The indicator of the selected preset setting button lights up. The effects of preset settings are as follows:

Press	to get (from SELECT 5)	To get (from MORE 5)
FILE 1	ROCK	GAME
FILE 2	POPS	DANCE
FILE 3	JAZZ	PARTY
FILE 4	CLASSIC	NIGHT
FILE 5	SALSA	MOVIE

“SUR ((|●|)) ” appears in the display if you select an effect with surround effects.

To cancel the audio emphasis

Press EFFECT (or MUSIC MENU ON/OFF on the remote) once so that the EFFECT indicator and the selected preset setting indicator go off.
“EFFECT OFF” appears in the display.

To change the equalizer display

Each time you hold down DISPLAY/DEMO for a few seconds, the equalizer display changes to show one of the following displays:

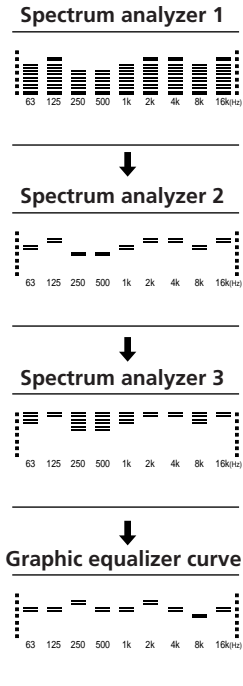

Adjusting the Sound (graphic equalizer)

This feature lets you adjust the audio emphasis by raising and lowering the level of frequency ranges. Before operation, first select the audio emphasis you want for your basic sound.

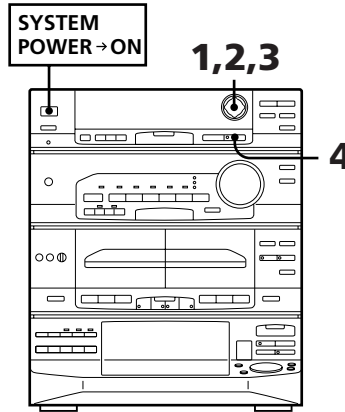

1 Press one of ◀, ▶, ▲ or ▼ (CURSOR CONTROL).
The frequency range appears and the level value flashes in the display.

2 Press ◀ or ▶ to select the frequency range you want to change.

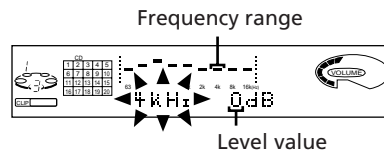

3 Press ▲ or ▼ to raise or lower the level of the frequency range.

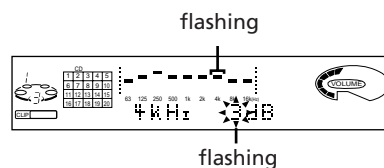

4 Repeat steps 2 and 3 to adjust other frequency ranges and press ENTER/NEXT.

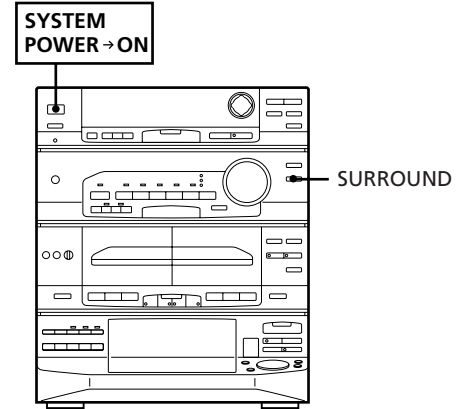

To turn on the surround effect

Press SURROUND.
“SUR ((|●|)) ” appears in the display.

To turn off the surround effect

Press SURROUND so that “SUR ((|●|)) ” disappears from the display.

Making Your Personal Audio Emphasis File (personal file)

You can create a personal file of audio patterns and store them in the player's memory. Later, call up this audio pattern to play a favourite tape, CD, or radio programme. You can create up to five audio files.

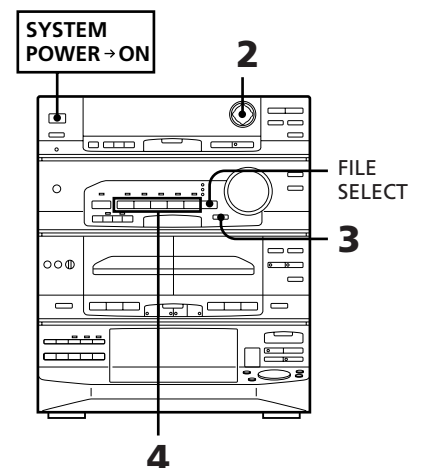

continue to next page →

Adjusting the Audio Emphasis

You can adjust the audio emphasis using the following two functions:

- Graphic equalizer
- Surround effect

Activating the Sound Field (Surround)

You can use the surround effect without connecting the surround speakers. Before operation, first select the audio emphasis you want for your basic sound.

continued →

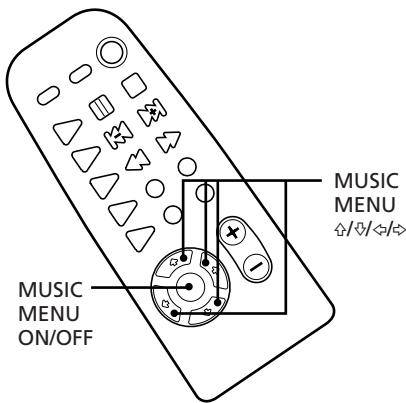

- 1 Obtain the sound effect you want. (See “Selecting the Audio Emphasis” and “Adjusting the Audio Emphasis” for details).
- 2 Adjust the sound with the CURSOR CONTROL (See “Adjusting the Audio Emphasis” for details).
- 3 Press MEMORY.
“MEMORY” appears and “F 1 – 5” flashes in the display.

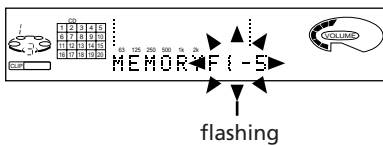

- 4 Press one of the FILE 1 – 5 button where you want the sound effect.
“MEMORY” disappears and the name of the file you stored appears in the display.

To call up the personal file

Press FILE SELECT (or MUSIC MENU ↕/↔ on the remote) to select P FILE. The P FILE indicator of lights up. Then press one of the FILE 1 – 5 buttons (or MUSIC MENU ↕/↔ on the remote).

To erase the personal file

Store a new personal file at a previously used personal file number (FILE 1 – 5) to erase the old personal file.

Note

If you press SURROUND when you choose one of the preset settings (SELECT 5 and MORE 5), the preset setting will be cancelled automatically.

Chapter 6: Additional Features

Falling Asleep to Music

Waking Up to Music

Timer-Recording Radio Programs

Microphone Mixing

Karaoke: Singing Along

Connecting Optional Equipment

Falling Asleep to Music

You can set the stereo system to turn off automatically so you can fall asleep to music (Sleep timer).

Before setting the sleep timer, make sure the clock has been set correctly.

You can set the sleep timer even if you have set the daily or recording timer.

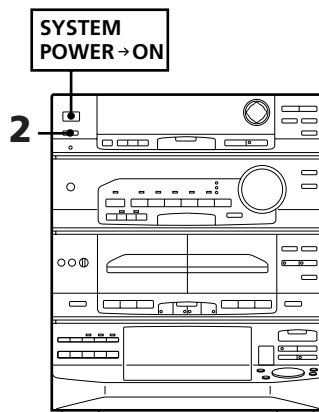

- 1 Play your favourite sound source (a tape, the tuner or a CD).
- 2 Press SLEEP repeatedly to choose how long you want the music to play. "SLEEP" and minutes indication appear in the display. The power will turn off after 10 to 90 minutes depending on the length of time you choose.

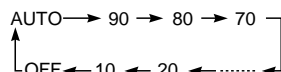

When you choose AUTO

The power turns off when the current CD or tape finishes playback (for up to 100 minutes).

The power turns off even when you stop playing a CD, a tape or pause a tape while playing.

To cancel the sleep timer

Press SLEEP repeatedly until "OFF" appears in the display.

To check the remaining time before the sleep timer turns off the system

Press SLEEP once.

The remaining time (in minutes) is displayed for several seconds.

To change the remaining time while the sleep timer is on

Press SLEEP repeatedly to select the remaining time you desire.

Note

While the sleep timer is turned on, the daily and recording timer do not work.

Waking Up to Music

You can wake up to music at a preset time. You only need to set the timer once. When you select the CD player as the sound source, you can play a CD in any mode (normal, shuffle, or programme). Before setting the timer, make sure the clock has been set correctly. You can set the daily timer even if you have set the sleep or recording timer.

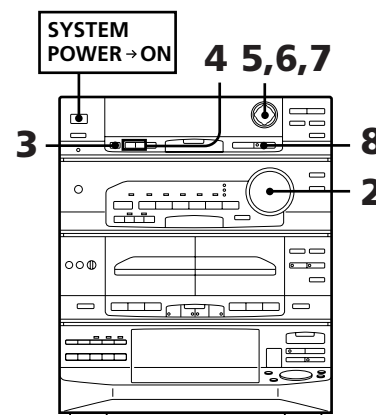

- 1 Prepare the sound source.

To wake up to the radio

Tune in the preset station you want.

To wake up to a CD

Insert a CD and close the front cover. Make sure the disc number in the playing position in the display is the one you want to play.

If you want to play from a specific track, follow the procedures for programmed CD play (See "Playing Tracks in Desired Order (programme play)").

To wake up to a tape

Insert the tape with the side you want to play facing forward. If you insert the tapes in both decks, you will hear the sound from deck B.

- 2 Turn the VOLUME control to adjust the volume.

The music will start playing with the adjusted volume when the preset time comes.

continue to next page →

continued →

- 3** Press **TIMER SET**.
"SELECT TIMER" appears in the display.
- 4** Press **DAILY 1** or **DAILY 2**.
"ON" and the timer indication appear and the hour digits flash in the display.

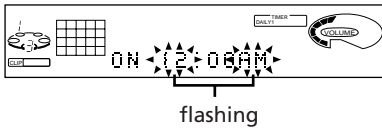

- 5** Press **◀** or **▶** (**CURSOR CONTROL**) to set the hour you want the system to turn on, then press **ENTER/NEXT**.
Set the minutes in the same way. "OFF" appears and the hour digits flash in the display.

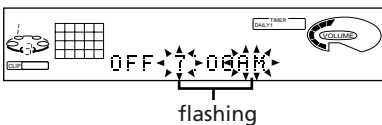

- 6** Press **◀** or **▶** to set the hour you want the system to turn off then press **ENTER/NEXT**.
Set the minutes in the same way.
- 7** Press **◀** or **▶** to select a sound source.
The display changes as follows:

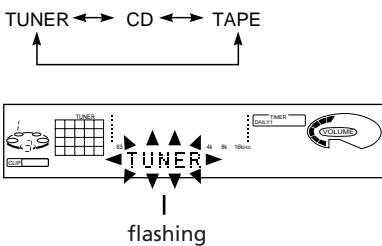

- 8** Press **ENTER/NEXT**.
The preset items appear in order in the display.
- 9** Press **SYSTEM POWER** to turn off the system.
The power will turn on at the preset time and the music will play with the volume you have adjusted.
At the turn-off time, the power will go off again.

To change the preset timer settings
Start over from step 1.

To check the preset timer settings

- 1** Press **DAILY 1** or **DAILY 2** which ever you have set once.
- 2** "TIMER OFF" appears in the display.
- 3** Press **DAILY 1** or **DAILY 2** again.
The preset items appear in order in the display, then "DAILY 1 ON" or "DAILY 2 ON" appears in display.

To change the timer

Press the desired timer button.

To cancel the timer

- 1** Press **DAILY 1** or **DAILY 2** which ever you have set once.
- 2** "TIMER OFF" appears in the display.

Notes

- You cannot set **DAILY 1** and **DAILY 2** at the same time.
- You cannot set timer if the timer on and off times are the same.
- When you set the sleep timer, daily timer does not turn on until the system turns off by the sleep timer.
- You cannot activate daily timer and recording timer at the same time.

Timer-Recording Radio Programmes

You can set the timer to record the radio. This timer works only once for each setting. The volume level is automatically set to the minimum.

Make sure the clock has been set correctly and preset the station beforehand. (See "Presetting Radio Stations").

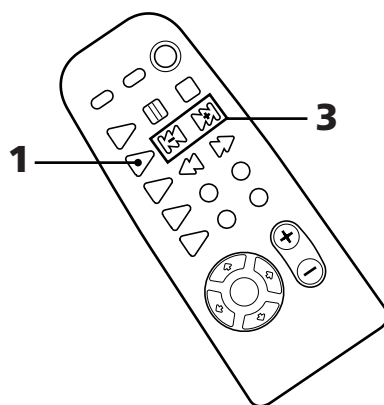
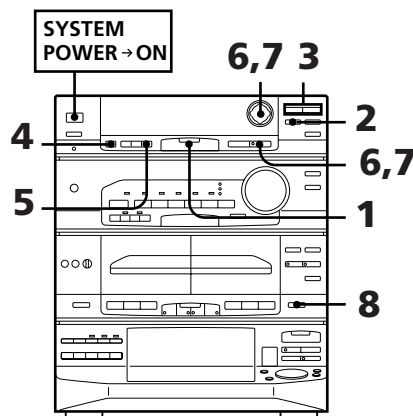

- 1** Press **TUNER/BAND** repeatedly until the band you want appears in the display.

- 2** Press **TUNING MODE** repeatedly until "PRESET" appears in the display.

- 3** Press **TUNING +/-** button (or /) on the remote) to tune in a preset station.

- 4** Press **TIMER SET**.
"SELECT TIMER" appears in the display.

- 5** Press **REC**.
"ON" appears and the hour digits and "AM" flash in the display.

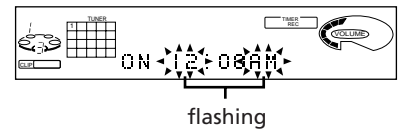

- 6** Set the hour you want to start recording by pressing **◀** and **▶** (**CURSOR CONTROL**), then press **ENTER/NEXT**.
Set the minutes in the same way. "OFF" appears and the hour digits flash again.

- 7** Set the hour you want to stop recording by pressing **◀** and **▶** (**CURSOR CONTROL**), then press **ENTER/NEXT**.
Set the minutes in the same way.
The preset items appear in order in the display.

- 8** Insert a tape in deck B with the side you want to record facing forward.
Recording always starts from the front side. If necessary select the direction mode. You can use **TYPE I** (normal) or **TYPE II** (CrO₂) tapes.

- 9** Press **SYSTEM POWER** to turn off the system.
The power will turn on at the preset time and the recording will start with the minimum volume level automatically.
At the turn-off time, the power will go off again.

To cancel the timer settings

Press **REC** so that "TIMER REC" disappears from the display. Press **REC** again to activate the timer.

To check the timer settings

Press **REC** twice in succession.

To change the timer settings

Repeat step 1 to 9.

Notes

- The band and station will be recalled as you have set them, but the recording does not start if the system power is on.
- You cannot activate recording timer and daily timer at the same time.

Microphone Mixing

You can “mix” sounds by playing one of the components and singing or speaking into a microphone (not supplied). The mixed sounds can then be recorded on a tape.

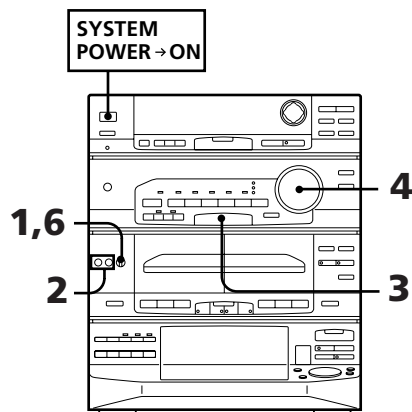

- 1** Turn MIC LEVEL to MIN to turn down the microphone control level.
- 2** Connect the microphone (not supplied) into the MIC 1 jack. When you use two microphones simultaneously, connect the other one into the MIC 2 jack.
- 3** Press one of the function buttons (or press FUNCTION repeatedly) to select a sound source and play it.
- 4** Adjust VOLUME. If you hear acoustic feedback, move the microphone away from the speakers or change the direction of the microphone.
- 5** Sing or speak into the microphone.
- 6** Turn MIC LEVEL to adjust the microphone level.
- 7** If you want to record mixed sound, insert a tape in deck B and start recording.

To record from the microphone only

- 1** Press FUNCTION repeatedly until “CD” appears in the display. If a CD is being played, press \square to stop playing.
- 2** Start recording.
- 3** Sing or speak into the microphone.

When you finish mixing

Disconnect the microphone and turn the MIC LEVEL control to MIN.

Echoing the Microphone Sound

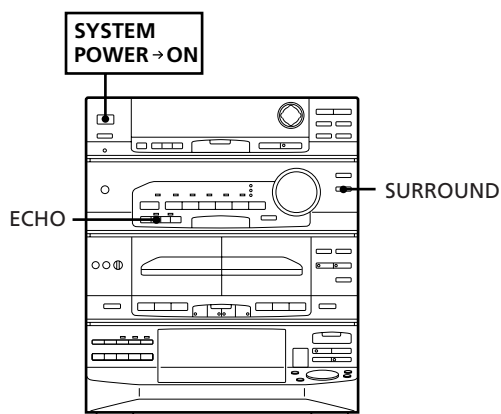

Press ECHO repeatedly to select the level you want. As you press the button, the display changes as follows:

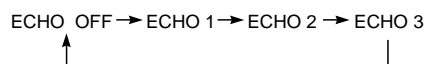

To cancel the echoing

Press ECHO repeatedly until “ECHO OFF” appears in the display.

Note

The surround effect is cancelled when ECHO is on. The surround effect does not automatically return to the previous setting when ECHO is off. Press SURROUND to set up the surround effect again.

Karaoke: Singing Along

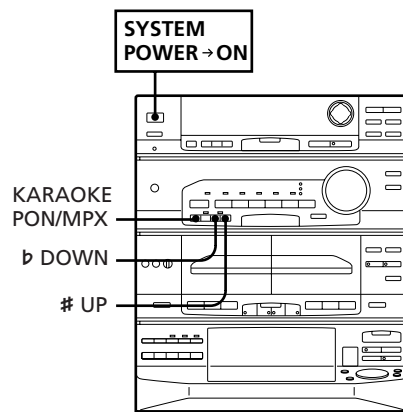

To Reduce the Vocals (karaoke pon)

You can minimize the singer’s voice, “vocal reduction”, so you can sing along with any stereo CD. When you want to record the sound of the CD and your voice, operate steps below, then operate “Microphone Mixing”.

To reduce the vocals

Press KARAOKE PON/MPX repeatedly until “ \backslash PON” appears.

As you press the button, the indication changes as follows:

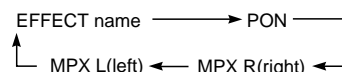

The karaoke play sound will be in monaural. To cancel vocal reduction, press KARAOKE PON/MPX repeatedly until “ \backslash PON”, “ \backslash MPX R” or “ \backslash MPX L” disappears.

Notes on vocal reduction

The singer’s voice may not be reduced completely for the following reasons:

- Monaural recorded source (Instruments may also be reduced.)
- Only a few instruments are playing in the stereo recorded source
- The source has strong echoes or chorus
- The singer’s voice on the source deviates from the centre
- The voice on the source is singing in high soprano or tenor

Note

When you select “ \backslash PON”, the audio emphasis (SELECT 5 and surround effect) except DBFB does not activate (the indicators of EFFECT and “SUR (|||||)” go off). When you want the audio emphasis back, press EFFECT so that voice reduction turned off and the previous setting of the audio emphasis before you press KARAOKE PON/MPX activates again.

To Sing Along with Multiplex CDs or Tapes

You can sing along using the microphone while playing back a multiplex CDs or tape. On a standard multiplex CDs or tape, a singer’s voice is recorded on the right channel and instrumental music is on the left channel.

continue to next page →

continued →

Press KARAOKE PON/MPX repeatedly until “MPX R” or “MPX L” appears in the display (choose right (R) or left (L)/according to the encoding on your MPX software).

Then, you can hear the voice through the microphone and the instruments.

To hear both channels (the instruments and the recorded singer's voice)

Press KARAOKE PON/MPX until “MPX” disappears from the display and the effect indicator lights up.

Note

When you select “MPX”, you cannot activate the audio emphasis (the indicators of the audio emphasis except of DBFB go off.) When you want the audio emphasis back, press EFFECT so that the previous setting of the audio emphasis before you press KARAOKE PON/MPX activates again.

If you press EFFECT (or MUSIC MENU ON/OFF on the remote) or recall a sound effect from one of the FILE 1 – 5 buttons

The karaoke mode is cancelled.

To adjust the key control

Press KEY CONTROL **↓** DOWN or **↑** UP. You can adjust the key higher or lower in 13 steps (-3.0 to 3.0). Each step is a halftone (0.5).

Connecting Optional Equipment

For greater enjoyment of your stereo system, you can connect other components to the stereo. You can connect :

- surround speakers to the SURROUND SPEAKER connectors on the rear panel
- a VCR to the VIDEO (AUDIO) IN jacks
- a turntable to the PHONO IN jacks
- headphones to the PHONES jack on the front panel

To connect surround speakers

- 1 Connect surround speakers to the right and left SURROUND SPEAKER connectors.
- 2 Press SURROUND so that “SUR  ” appears in the display. You can create the atmosphere of a movie theatre or concert hall.

To connect a VCR

- 1 Connect a VCR or other video equipment to the VIDEO (AUDIO) IN jacks.
- 2 Press FUNCTION repeatedly until “VIDEO” appears in the display. The connected sound source comes through the speakers. You can also record the VCR sound.

To connect a turntable

- 1 Connect the turntable to the PHONO IN jacks on the rear panel.
- 2 Press FUNCTION until “PHONO” appears in the display. The turntable sound comes through the speakers. You can also record the turntable sound.

Note

When you use the turntable, adjusting the volume high may cause distortion or howling. This is often caused by the bass sound from the speakers which vibrate the floor and air. That vibration could be picked up by the needle of the turntable, and produce the distortion or howling. To avoid distortion or howling, do the following:

- 1 Keep some distance between the speakers and the turntable.
- 2 Stop using the surround effect.
- 3 Install the speakers or the turntable on a firm and solid place.
- 4 Set DBFB to “DBFB  ” or off.

For Your Information

Precautions

Troubleshooting Guide

Maintenance

Specifications

Index to Parts and Controls

Index

Precautions

If you have any questions or problems concerning your stereo system, please consult your nearest Sony dealer.

On operating voltage

Before operating the stereo system, check that the operating voltage of your stereo system is identical with the voltage of your local power supply.

220 – 240 V AC, 50/60 Hz

On safety

- The stereo system is not disconnected from the AC power source (mains) as long as it is connected to the wall outlet, even if the system itself has been turned off.
- Unplug the system from the wall outlet (mains) if it is not to be used for an extended period of time. To disconnect the cord (mains lead), pull it out by the plug. Do not pull the cord itself.
- Should any solid object or liquid fall into a component, unplug the stereo system and have the component checked by qualified personnel before operating it any further.
- Should the AC power cord (mains lead) need to be changed, have it done at a qualified service shop only.
- As the laser beam used in this unit is harmful to the eyes, do not attempt to disassemble the cabinet. Refer servicing to qualified personnel only.

On installation

Place the stereo system in a location with adequate ventilation to prevent heat buildup in the stereo system.

On condensation in the CD player component

If the system is brought directly from a cold to a warm one, or is placed in a very damp room, moisture may condense on the lens inside any CD player. Should this occur, the CD player will not operate. Remove any CDs and leave the system turned on for about an hour until the moisture evaporates.

To save a tape permanently

To prevent a tape from being accidentally recorded over, break off the cassette safety tab from side A or B as illustrated. If you later want to reuse the tape for recording, cover the broken tab with adhesive tape.

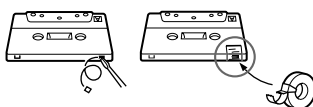

When you are using a type II (CrO₂) cassette, be careful not to cover the detector slots which allow the tape player to automatically detect the type of tape.

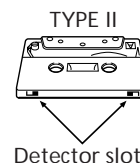

If in case color irregularity is observed on nearby a TV screen.

With the magnetically shielded type of speaker system, the speakers can be installed near a TV set. However, color irregularity may still be observed on the TV screen depending on the type of your TV set.

If color irregularity is observed...

Turn off the TV set once, then turn it on after 15 to 30 minutes.

If color irregularity is observed again...

Place the speakers farther away from the TV set.

Troubleshooting Guide

If you run into any problem using this stereo system, use the following check list. First check the following points.

- The mains lead is connected firmly.
- The speakers are connected correctly and firmly.

Should any problem persist after you have made the checks below, consult your nearest Sony dealer.

Tuner

"TUNED" flashes in the display.

→ Adjust the aerial.

"STEREO" flashes in the display.

→ Adjust the aerial.

Severe hum or noise.

→ Adjust the aerial.

→ The signal strength is too weak.
Connect the external aerial.

→ Connect the ground wire.

A stereo FM programme cannot be received in stereo.

→ Press STEREO/MONO so that "STEREO" appears.

Tape Player

The tape does not record.

- No tape in the cassette holder.
- The safety tab has been removed from the cassette.
- The tape has reeled to the end.

The tape does not record nor play back or there is a decrease in sound level.

- The heads are dirty. Clean them.
- Magnetic deposits have built-up on the record/playback heads.*

There is excessive wow or flutter, or the sound drops out.

- The capstans or pinch rollers are contaminated.*

The tape does not erase completely.

- Magnetic deposits have built-up on the record/playback heads.*

Noise increases, or the high frequencies are erased.

- Magnetic deposits have built-up on the record/playback heads.*

* See "Maintenance".

CD Player

The CD will not play.

- The CD is dirty.
- The CD is inserted label side down.
- Moisture condensation has built up. Leave the system turned on for about an hour until the moisture evaporates.

Play does not start from the first track.

- The player is in programme or shuffle mode. Press CONTINUE.

Microphone Mixing/ Karaoke

There is no microphone sound.

- Turn VOLUME or MIC LEVEL to adjust the microphone volume.
- Make sure that the microphone is connected to the MIC jack correctly.

You hear acoustic feedback when using the microphone.

- Turn MIC LEVEL to MIN.
- Move the microphone away from the speakers or change the direction of the microphone.

General

There is no sound.

- Rotate the VOLUME clockwise.
- The headphones are connected. Disconnect them.

Sound comes from one channel, or is unbalanced between the left and right speakers.

- Check the speaker connections of the inoperative channel.

The left and right sounds are reversed.

- Check the speaker connections and speaker placement.

There is no bass or the location of the musical instruments is apparently imprecise.

- Check the speaker connection for proper phasing.

There is severe hum or noise.

- The TV, VCR or speakers is too close to the stereo system. Move the stereo system away from the TV, VCR or speakers.

"12:00 AM" flashes in the display.

- A power interruption occurred. Set the clock again.

The remote does not function.

- The batteries have run down. Replace both batteries.
- There is an obstacle between the remote and the system. Remove the obstacle.

Maintenance

To clean the tape heads and tape path

Contaminated tape heads cause poor recording or sound dropout in playback. We recommend cleaning after every 10 hours of operation.

Open the cassette holder and wipe the heads, pinch rollers and capstans with a cleaning swab slightly moistened with cleaning fluid or alcohol. Wipe the parts shown below:

Deck A

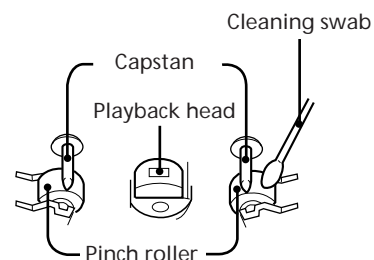

Deck B

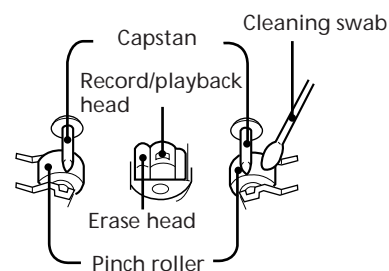

Insert a tape after the areas cleaned are completely dry.

To demagnetize the tape heads

After 20 to 30 hours of use, enough residual magnetism will have built up on the heads to begin to cause loss of high frequencies and hiss. At this time, demagnetize the heads and all metal parts in the tape path with a commercially available tape head demagnetizer. Refer to the instructions of the demagnetizer.

To clean the cabinet

Use a soft cloth slightly moistened with a mild detergent solution.

To clean the CD

When a CD is dirty, clean it with a cleaning cloth. Wipe the CD from the centre out.

Notes on CDs

- Do not use solvents such as benzene, thinner, commercially available cleaners, or antistatic spray intended for vinyl LPs.
- If there is a scratch, dirt or fingerprints on the CD, it may cause a tracking error.

Specifications

CD player section

System	Compact disc and digital audio system
Laser	Semiconductor laser ($\lambda = 780 \text{ nm}$)
	Emission duration: continuous
laser output	Max 44.6 μW *

* This output is the value measured at a distance of 200 mm from the objective lens surface on the Optical Pick-up Block with 7 mm aperture.

Wavelength 780 - 790 nm

Tuner section

FM stereo, FM/AM superheterodyne tuner

FM tuner section

87.5 – 108.0 MHz
(50 kHz step)

Aerial FM wire aerial
Aerial terminals 75 ohm unbalanced
Intermediate frequency 10.7 MHz

AM tuner section

Tuning range

AM: 531 – 1,602 kHz
(with the AM tuning interval set at 9 kHz)
530 – 1,710 kHz
(with the AM tuning interval set at 10 kHz)

Aerial AM loop aerial
External aerial terminals

Intermediate frequency 450 kHz

Tape player section

Recording system

4-track 2-channel stereo

Frequency response

40 – 13,000 Hz (± 3 dB), using
SONY TYPE I cassette
40 – 14,000 Hz (± 3 dB), using
SONY TYPE II cassette

Wow and flutter

$\pm 0.15\%$ W.Peak (IEC)
0.1% W.RMS (NAB)
 $\pm 0.2\%$ W.Peak (DIN)

Amplifier section

Peak music power output:

1,200 W (6 Ω at 1 kHz, 10%
THD)

Continuous RMS power output:

60 W + 60 W (6 Ω at 1 kHz, 5%
THD)

Inputs

PHONO (phono jack):

Sensitivity 3 mV, impedance
47 kilohms

VIDEO (AUDIO) (phono jack):

Sensitivity 250 mV, impedance
47 kilohms

MIC (phone jack):

Sensitivity 1 mV, impedance
10 kilohms

Outputs

PHONES (phone jack):

accept headphones of 8 ohms or more

SPEAKER: accept impedance of 6 to

16 ohms

SURROUND SPEAKER:

accept impedance of 8 to
16 ohms

Supplied accessories

AM loop aerial (1)

Remote RM-SD50 (1)

Sony SUM-3 (NS) batteries (2)

FM wire aerial (1)

Front speakers SS-N355 (2)

Speaker cords (2)

Rack SU-N355 (1)

General

Power requirements

220 – 240 V AC, 50/60 Hz

Power consumption

180 W

Dimensions

Approx. 355 × 425 × 400 mm
(14 × 16 ³/₄ × 15 ³/₄ inches) (w/h/d)
incl. projecting parts and controls

Mass

Approx. 11.7 kg (25 lb 13 oz.)

Design and specifications subject to change without notice.

Index to Parts and Controls

Refer to the pages indicated in parentheses for details on how to use the controls.

Front Panel

Tuner section

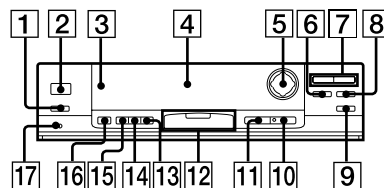

- 1 SLEEP button (23)
- 2 SYSTEM POWER switch (7)
- 3 Remote sensor
- 4 Display window (30)
- 5 CURSOR CONTROL buttons (6, 21)
- 6 TUNING MODE button (12)
- 7 TUNING +/- buttons (12)
- 8 TUNER MEMORY button (13)
- 9 STEREO/MONO button (12)
- 0 ENTER/NEXT button (6, 9, 21)
- ! j DISPLAY/DEMO button (6, 8, 21)
- !™ TUNER/BAND button (12, 18, 24)
- ! £ REC button (24)
- ! ¢ DAILY 2 button (23)
- ! ¤ DAILY 1 button (23)
- ! § TIMER SET button (23)
- ! ¶ CLOCK SET button (6)

Amplifier section

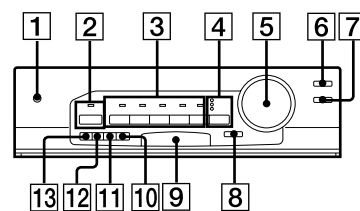

- 1 PHONES jack (20)
- 2 EFFECT button/indicator (20)
- 3 FILE 1 – 5 buttons/indicators (20, 21)
- 4 FILE SELECT button/indicators (20, 21)
- 5 VOLUME control (7, 20)
- 6 DBFB button (20)
- 7 SURROUND (15, 21)
- 8 MEMORY button (21)
- 9 FUNCTION button (7, 14)
- ! ° n UP button (26)
- ! j ~ DOWN button (26)
- !™ ECHO button (25)
- ! £ KARAOKE PON/MPX button (25)

Tape player section

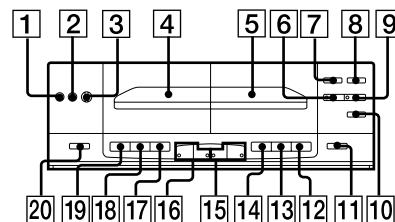

- 1 MIC 1 jack (25)
- 2 MIC 2 jack (25)
- 3 MIC LEVEL control (25)
- 4 Cassette compartment for DECK A (14)
- 5 Cassette compartment for DECK B (14)
- 6 (pause) button (14)
- 7 HIGH SPEED DUBBING button (19)
- 8 CD SYNCHRO button (15)
- 9 REC (recording) button (15)
- 0 DIRECTION button (15)
- ! j § EJECT button for DECK B (14)
- !™ , (fast rightward) button for DECK B (14)
- ! £ ° (fast leftward) button for DECK B (14)
- ! ¢ STOP button for DECK B (14)
- ! ¤ a/. (play) button for DECK B (14)
- ! § a/. (play) button for DECK A (14)
- ! ¶ , (fast rightward) button for DECK A (14)
- ! ° (fast leftward) button for DECK A (14)
- ! ¤ a STOP button for DECK A (14)
- @° § EJECT button for DECK A (14)

CD player section

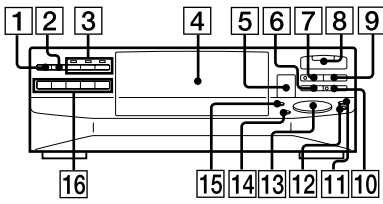

- 1 MUSIC CLIP PLAY button (11)
- 2 MUSIC CLIP ERASE button (11)
- 3 CLIP A, B, C buttons/indicators (10)
- 4 Front cover (7)
- 5 § OPEN button (7)
- 6 DISC SKIP button (7)
- 7 (pause) button (7)
- 8 · (play) button (7)
- 9 (stop) button (7)
- !° AUTO button/indicator (7)
- !j PROGRAM button (9)
- !™ REPEAT button (9)
- !£ JOG dial (7)
- !¢ SHUFFLE buttons (8)
- ! CONTINUE button (7)
- !§ DISC 1 - 5 buttons (7)

Rear Panel

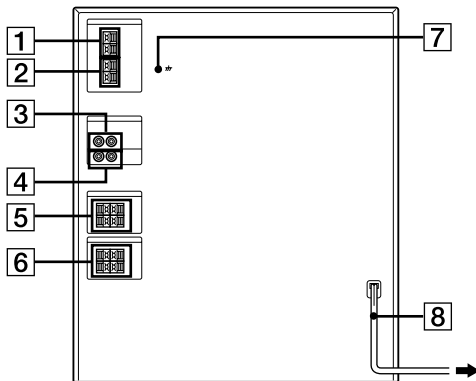

- 1 AM terminal (4)
- 2 FM 75Ω terminal (4)
- 3 PHONO IN jacks (26)
- 4 VIDEO (AUDIO) IN jacks (26)
- 5 SPEAKER connectors (5)
- 6 SURROUND SPEAKER connectors (5)
- 7 y ground terminal (5)
- 8 AC power cord (6)

Display Window

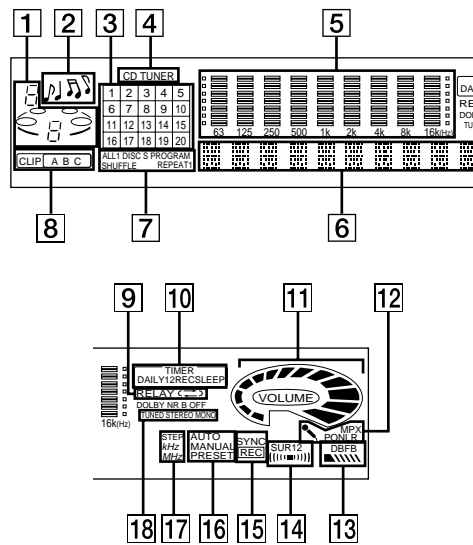

- 1 Disc calendar (7)
- 2 Demo mode indications (6)
- 3 Music calendar (7)
- 4 CD/TUNER indication (7)
- 5 Graphic Equalizer indication (21)
- 6 Multi-display (7, 12, 21)
- 7 CD play mode indications (8)
- 8 CLIP indicator (11)
- 9 Tape direction mode indication (14)
- 0 Timer indication (24)
- ! j VOLUME indication (7)
- !™ KARAOKE h PON/MPX R L indication (25)
- !£ DBFB indication (20)
- ! ¢ SUR indication (15, 21)
- ! SYNC REC indicator (15)
- ! § Tuning mode indications (12)
- ! ¶ STEP/frequency waves indication (12)
- ! • TUNED/STEREO/MONO indications

Remote

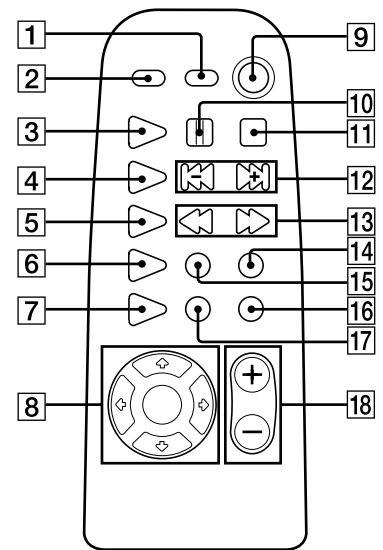

- 1 SLEEP button (24)
- 2 LOOP button (10)
- 3 ▷ CD (play) button (7)
- 4 TUNER/BAND ▷ button (12)
- 5 DECK A ▷ button (14)
- 6 DECK B ▷ button (14)
- 7 FUNCTION button (7, 14)
- 8 MUSIC MENU buttons (20, 21)
- 9 POWER button (7)
- !° □□ (pause) (7)
- ! j □ (stop) (7)
- !™ [] buttons (7, 12, 17)
- ! £ ◀ / ▶ buttons (7, 8)
- ! ¢ EDIT button (8, 17)
- ! CHECK button (8, 17)
- ! § DISC SKIP button (7)
- ! ¶ CLEAR button (8, 17)
- ! • VOL (volume) +/- buttons (7, 20)

Index

- Aerial 4
- AMS 8
- CD player 7
- Clock setting 6
- Connecting
 - the stereo 4
 - optional equipment 26
- Display indications 6, 21
- Dubbing 19
- Grouping tracks (music clip) 11
- Inserting batteries 6
- Karaoke
 - to reduce the vocals (karaoke
pon) 25
 - to sing along with multiplex
tapes 25
 - to adjust the key control 26
- Maintenance 28
- Microphone
 - mixing 25
 - echoing the microphone sound 25
- Music calendar 7
- Normal play 7
- Parts identification 29
- Personal file 21
- Playing
 - a CD (normal play) 7
 - a tape 14
 - preset radio stations 13
 - several CDs 7
 - tracks in random order
(shuffle play) 8
 - tracks in desired order
(programme play) 9
 - tracks repeatedly 9
 - tracks with repeating a specified
portion (loop play) 10
- Radio stations
 - presetting 13
 - tuning in 12
- Recording
 - a CD 14
 - selecting tape length automatically
(tape select edit) 16
 - specifying tape length (time edit) 16
- Recording
 - a radio programme 18
 - another tape (dubbing) 18
- Relay play 14
- Repeating CD tracks 9
- Scanning stored stations 13
- Shuffle play 8
- Sleep timer 24
- Sound adjusting 20
- Tape player 14
- Timer
 - falling asleep to music 24
 - waking up to music 24
 - timer-recording radio
programme 25
- Tuner playing 12

