

Flat Component System

Operating Instructions

f T

MJ-L1

WARNING

To prevent fire or shock hazard, do not expose the unit to rain or moisture.

To avoid electrical shock, do not open the cabinet. Refer servicing to qualified personnel only.

Do not install the appliance in a confined space, such as a bookcase or built-in cabinet.

U.S. and foreign patents licensed from Dolby Laboratories Licensing Corporation.

Laser component in this product is capable of emitting radiation exceeding the limit for Class 1.

This appliance is classified as a CLASS 1 LASER product. The CLASS 1 LASER PRODUCT MARKING is located on the rear exterior.

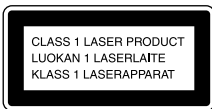

The following caution label is located inside the unit.

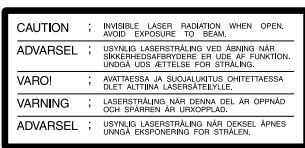

NOTICE FOR THE CUSTOMERS IN THE U.S.A.

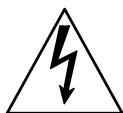
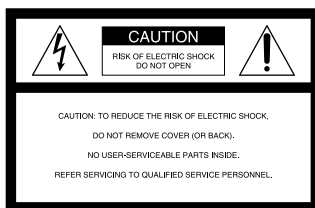

This symbol is intended to alert the user to the presence of uninsulated "dangerous voltage" within the product's enclosure that may be of sufficient magnitude to constitute a risk of electric shock to persons.



This symbol is intended to alert the user to the presence of important operating and maintenance (servicing) instructions in the literature accompanying the appliance.

Owner's Record

The model and serial numbers are located on the rear panel.

Record the serial number in the space provided below. Refer to them whenever you call upon your Sony dealer regarding this product.

Model No. MJ-L1
Serial No. _____

INFORMATION

This equipment has been tested and found to comply with the limits for a Class B digital device, pursuant to Part 15 of the FCC Rules. These limits are designed to provide reasonable protection against harmful interference in a residential installation. This equipment generates, uses, and can radiate radio frequency energy and, if not installed and used in accordance with the instructions, may cause harmful interference to radio communications. However, there is no guarantee that interference will not occur in a particular installation. If this equipment does cause harmful interference to radio or television reception, which can be determined by turning the equipment off and on, the user is encouraged to try to correct the interference by one or more of the following measures:

- Reorient or relocate the receiving antenna.
- Increase the separation between the equipment and receiver.
- Connect the equipment into an outlet on a circuit different from that to which the receiver is connected.
- Consult the dealer or an experienced radio/TV technician for help.

CAUTION

You are cautioned that any changes or modifications not expressly approved in this manual could void your authority to operate this equipment.

Note on CATV system installer:

This reminder is provided to call CATV system installer's attention to Article 820-40 of the NEC that provides guidelines for proper grounding and, in particular, specifies that the cable ground shall be connected to the grounding system of the building, as close to the point of cable entry as practical.

CAUTION

The use of optical instruments with this product will increase eye hazard.

NOTICE FOR THE CUSTOMERS IN CANADA

CAUTION:
TO PREVENT ELECTRIC SHOCK, DO NOT USE THIS POLARIZED AC PLUG WITH AN EXTENSION CORD, RECEPTACLE OR OTHER OUTLET UNLESS THE BLADES CAN BE FULLY INSERTED TO PREVENT BLADE EXPOSURE.

Welcome!

Thank you for purchasing the Sony Flat Component System. This series is packed with fun features. Here are just a few:

- A preset feature, that lets you store and recall up to 30 of your favorite radio stations
- A timer that lets you set the CD player, MD deck or radio to turn on and off whenever you want
- An MD deck that lets you record from the radio or CD player
- A remote that lets you control your system from your seat

The MJ-L1 consists of the following:

- Main unit : HCD-MJ1
- Speaker System : SS-MJ1
- Remote Control : RM-SMJ1

Before Using This Unit

Make sure to take out the sheet inside the disc slot on the MD deck.

- 1** Connect the AC power cord to the wall outlet and press POWER.
- 2** Press MD § to open the lid.
- 3** Remove the adhesive tape and take out the sheet inside the disc slot. The sheet may come out by itself when you remove the adhesive tape.

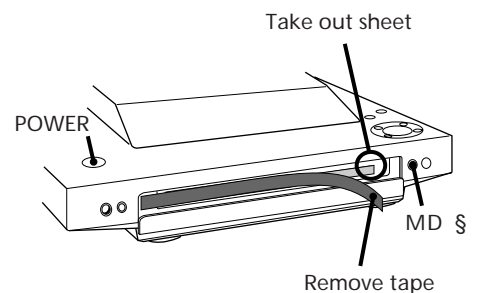

Before setting up the system, press MD § to close the lid, press POWER to turn off the power, and disconnect the AC power cord.

Table of Contents

Chapter 1: Setting Up

- Connecting the Stereo 4
- Inserting the Battery 6
- Setting the Clock 6

Chapter 2: the CD Player

- Playing a CD (normal play) 7
- Using the Display 8
- Playing Tracks Repeatedly (repeat play) 8
- Playing Tracks in Random Order (shuffle play) 9
- Playing Tracks in the Desired Order (program play) 9
- Assigning a Name to a CD (disc memo function) 10

Chapter 3: Playing MDs

- Playing an MD (normal play) 11
- Using the Display 12
- Playing Tracks Repeatedly (repeat play) 12
- Playing Tracks in Random order (shuffle play) 13
- Playing Tracks in the Desired Order (program play) 13

Chapter 4: Recording on MDs

- Before Recording 14
- Recording a CD 15
- Recording from the Radio 15
- Recording on an MD Manually 16
- Marking Track Numbers While Recording 16

Chapter 5: Editing Recorded MDs

- Erasing Recordings (erase function) 18
- Moving Recorded Tracks (move function) 19
- Dividing Recorded Tracks (divide function) 19
- Combining Recorded Tracks (combine function) 20
- Labeling Recordings (title function) 20

Chapter 6: the Radio

- Listening to the Radio 22
- Presetting Radio Stations 23
- Playing Preset Radio Stations 24

Chapter 7: Sound Adjustment

- Adjusting the Sound 25

Chapter 8: Additional Features

- Falling Asleep to Music 26
- Waking Up to Music 26
- Timer-Recording Radio Programs 27
- Connecting Optional Equipment 28

For Your Information

- Precautions 29
- Maintenance 29
- Guide to the Serial Copy Management System 30
- System Limitations of MD 31
- MD Display Messages 31
- Troubleshooting Guide 32
- Specifications 33
- Index to Parts and Controls 34

Index 35

Chapter 1: Setting Up

Connecting the Stereo

Inserting the Battery

Setting the Clock

Connecting the Stereo

Use the illustrations below to connect your stereo.

If you want to connect any optional components to the stereo, see “Connecting Optional Equipment” in Chapter 8.

STEP 1 Connecting the Speakers

Connect the right speaker to the SPEAKER R connectors and the left speaker to the SPEAKER L connectors with the gray cord to ‘ (gray) and the black-lined cord to ‘ (black).

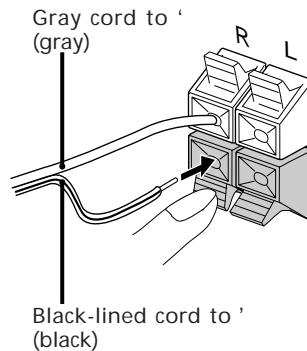

STEP 2 Connecting the Antennas

FM lead antenna connection

Connect the supplied lead antenna to the FM 75Ω terminal.

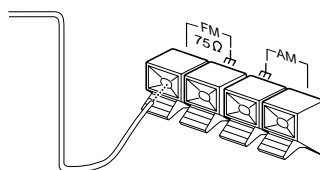

AM loop antenna connection

Connect the supplied loop antenna to the AM and the y terminals.

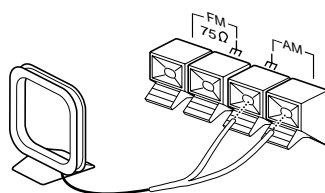

To set up the AM loop antenna

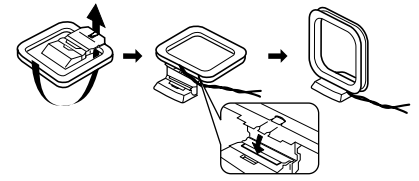

To improve the FM reception

Connect an outdoor FM antenna to the FM 75Ω terminal, using a 75-ohm coaxial cable.

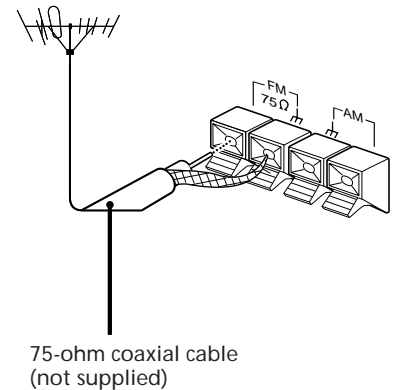

To improve the AM reception

After you connect the AM antenna, connect a 6- to 15-meter insulated wire to the AM terminal. Connect the y terminal to earth.

Important

Ground the external antenna against lightning from the y terminal.

To prevent a gas explosion, do not connect the ground wire to a gas pipe.

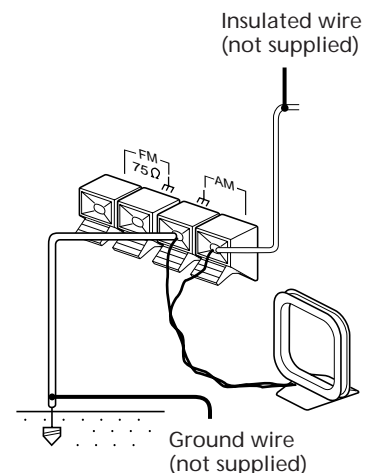

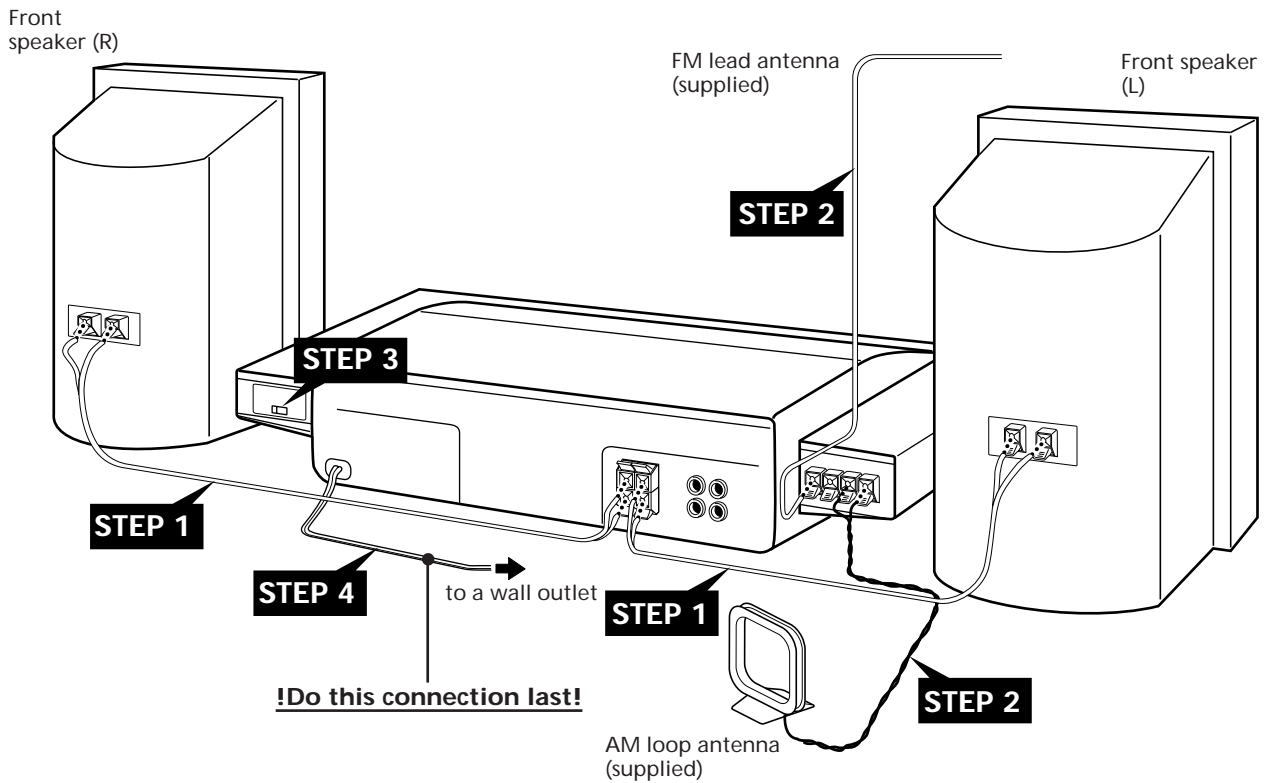

STEP 3 Adjusting the Operating Voltage (except for the U.S. and Canadian models)

Before connecting the power, set VOLTAGE SELECTOR to the position of your local power line voltage.

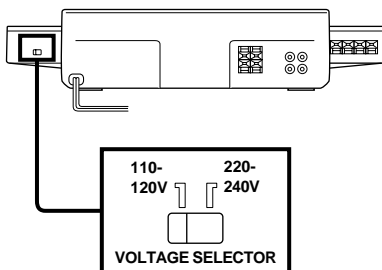

STEP 4 Connecting the Power

Connect the AC power cord to a wall outlet after you have made all the above connections.

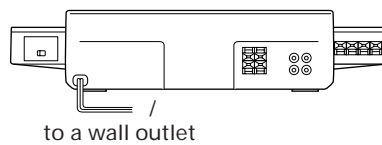

Plug Adapter (only for the model supplied with the plug adapter)
If the plug on this unit does not fit your wall outlet, attach the supplied adapter onto the plug .

Inserting the Battery

Install a lithium battery in the supplied remote for remote control.

- 1 Slide out and remove the battery case.

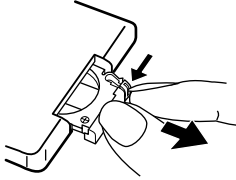

- 2 Insert a lithium battery CR2025 with the + side facing up.

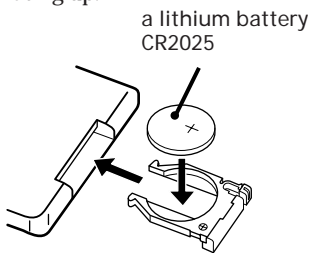

- 3 Insert the battery case.

CAUTION

Danger of explosion if battery is incorrectly replaced.

Replace only with the same or equivalent type recommend by the manufacturer. Discard used batteries according to the manufacturer's instructions.

Battery life

You can expect the remote to operate for about six months (using a Sony CR2025 lithium battery) before the battery run down. When the battery no longer operates the remote, replace the battery with a new one.

To avoid battery leakage

If you are not going to use the remote for a long time, remove the battery to avoid damage caused by corrosion from battery leakage.

Notes on lithium battery

- Keep the lithium battery out of the reach of children. Should the battery be swallowed, immediately consult a doctor.
- Wipe the battery with a dry cloth to assure a good contact.
- Be sure to observe the correct polarity when installing the battery.
- Do not hold the battery with metallic tweezers, otherwise a short-circuit may occur.

WARNING

Battery may explode if mistreated. Do not recharge, disassemble or dispose of in fire.

Setting the Clock

The built-in clock shows the time in the display even when the power is off. Use the buttons on the unit for this operation.

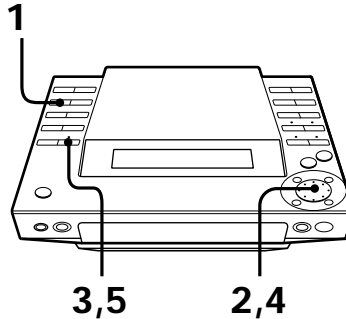

- 1 Press CLOCK.
- 2 Set the current hour by turning the JOG dial until the correct hour appears.

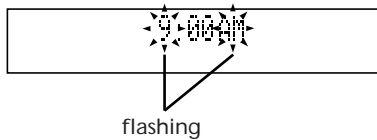

- 3 Press ENTER/YES. The minute indication begins flashing.

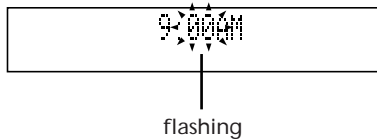

- 4 Set the current minute by turning the JOG dial until the correct minute appears.

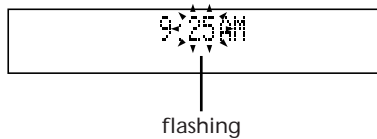

- 5 Press ENTER/YES. The clock starts running and the upper dot flashes. Use the time signal to set the clock accurately. The upper dot flashes for the first half of a minute (0 to 29 seconds), and the lower dot flashes for the last half of a minute (30 to 59 seconds).

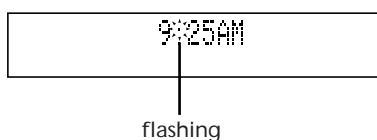

To check the time while power is on Press CLOCK. The current time is displayed for 4 seconds.

To correct the clock setting

With the power turned off, repeat steps 1 through 5. With the power turned on, press CLOCK twice and repeat steps 2 through 5.

Chapter 2: the CD Player

Playing a CD (normal play)

Using the Display

Playing Tracks Repeatedly (repeat play)

Playing Tracks in Random Order (shuffle play)

Playing Tracks in the Desired Order (program play)

Assigning a Name to a CD (disc memo function)

Playing a CD (normal play)

You can play a CD in four modes: normal, repeat, shuffle, and program. The mode decides which tracks (songs) you will listen to, in which order, and whether or not they will repeat.

You can operate the stereo system from the unit itself or from the supplied remote. You can play either a 12 cm (5-inch) or 8 cm (3-inch) CD. When you play an 8 cm CD, place it on the inner circle of the disc tray. Do not use a CD adapter.

Before you play the CD, decrease the sound level by pressing VOLUME -, to prevent damage to the speakers.

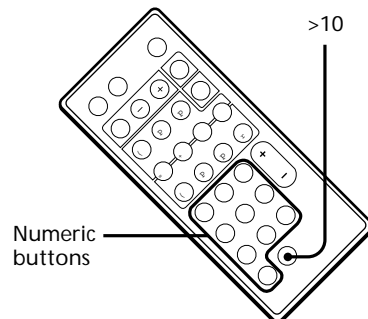
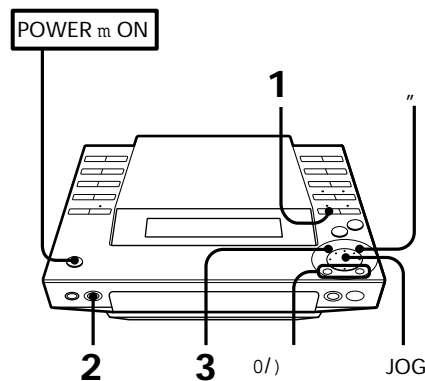

1 Press CD.
The unit enters the CD play mode.

2 Press CD § and place a CD (label side facing up) on the disc tray.

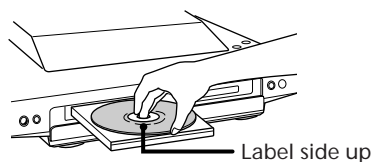

3 Press fl (or CD (on the remote).
The disc tray closes and the first track starts playing.

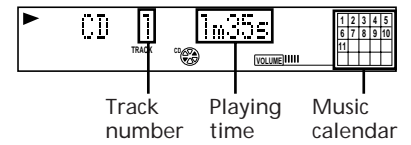

To	Press
Stop play	CD p*)
Pause	fl (CD P*)
Resume play	fl (CD (* or P*)
Go forward to another track	During play or pause, turn the JOG dial clockwise. Release when you reach the track you desire. Or use + on the remote.
Go back to a previous track	During play or pause, turn the JOG dial counterclockwise. Release when you reach the track you desire. Or use = on the remote.
Locate a specific track directly	Number buttons on the remote
Remove the CD	CD §

* Button on the remote

To directly locate a track numbered 11 or more

Press >10 first, then enter the corresponding digits.
Example: To locate track number 30, press >10, 3, and 10 in this order.

One Touch Play feature

Press CD (on the remote when the power is off. If a CD is loaded in the player, you will be able to listen to the CD without pressing any other buttons.
When you press CD on the unit, power turns on and function switches to CD automatically.

You can start playback from a desired track

- In step 2, turn the JOG dial until the desired track number appears on the display.
- Press fl.

continue to next page →

→ **continued**

To find a point in a track

You can find a particular point in a track while the track is playing or while it's in pause mode. Use the buttons on the unit to operate this feature.

To	Press
Go forward quickly in a track) on the unit and release it at the desired point.
Go backwards quickly in a track	0 on the unit and release it at the desired point.
Search quickly without listening	During pause, 0 or) on the unit and release it at the desired point.

Using the Display

You can use the display on the unit to check CD and track information such as the total number of tracks, total playing time of the CD, the time remaining on the CD, etc.

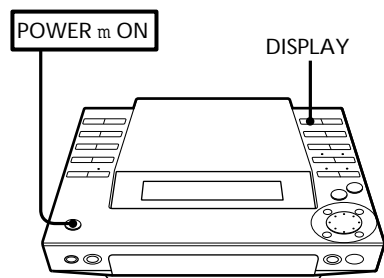

To check the remaining time during playback

Press DISPLAY repeatedly. Each time you press the button, the display changes as follows:

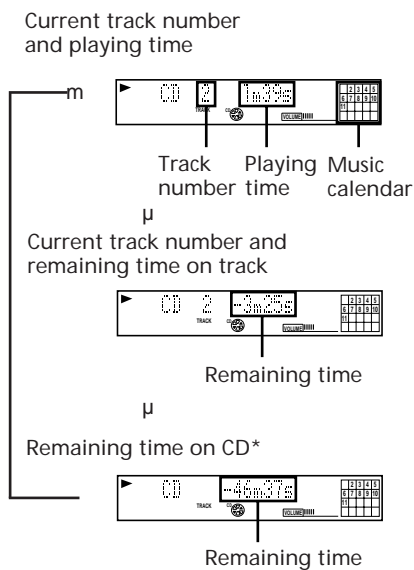

* Remaining time in program during program play

To check the disc memo, total number of tracks and the total playing time

Press DISPLAY in stop mode. If you stored a name for the disc (see "Assigning a Name to a CD"), the disc memo appears on the display. Each time you press the button, the display changes as follows:

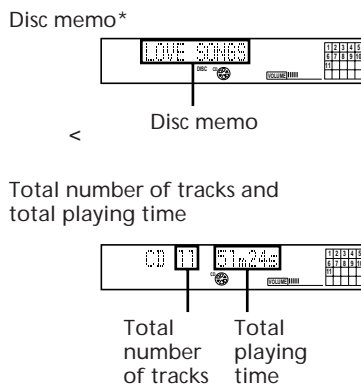

* Appears only if you stored a disc memo.

The Music Calendar Display

This display lights according to the number of tracks on the CD. As each track is played, the corresponding number disappears. Tracks numbered greater than 20 are not displayed.

Playing Tracks Repeatedly (repeat play)

You can choose between two different repeat play modes. One repeats all the tracks in the current play mode; the other repeats a single track.

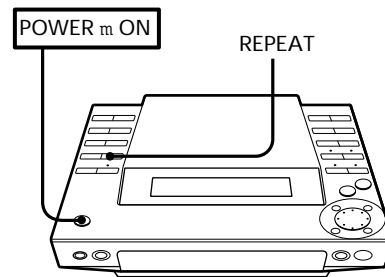

Repeating all the tracks

Press REPEAT repeatedly until "REPEAT" appears in the display.

Playing mode	Tracks played
Normal play	Repeats all the tracks on the CD.
Shuffle play	All tracks on the CD are reshuffled.
Program play	Repeats all the programs in their programmed order.

Repeating a single track (in normal play mode only)

While the desired track is being played, press REPEAT repeatedly until "REPEAT 1" appears in the display.

To cancel repeat play

Press REPEAT so that "REPEAT" or "REPEAT 1" disappears from the display.

Playing Tracks in Random Order (shuffle play)

You can play all the tracks on the CD in random order.

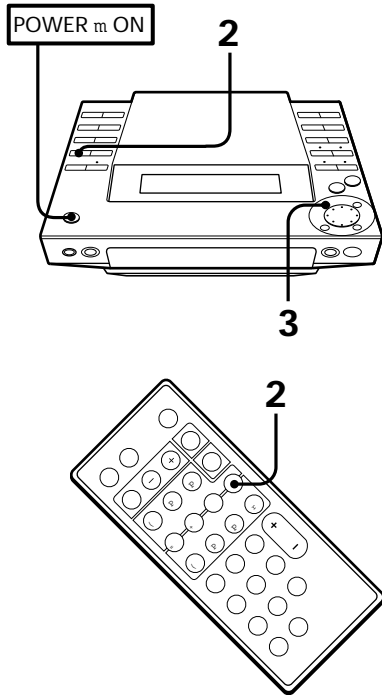

- 1 Press CD.
The unit enters CD play mode.
- 2 Press PLAY MODE (or P.MODE on the remote) repeatedly until "SHUFFLE" appears in the display.
- 3 Press fl.
"J" appears and then all the tracks play in random order.

To play the tracks in original order
Press PLAY MODE repeatedly until "SHUFFLE" and "PROGRAM" disappear from the display. The tracks continue playing in their original order.

To skip an undesired track

Turn the JOG dial clockwise (or press + on the remote).

Playing Tracks in the Desired Order (program play)

You can program up to 24 tracks to play in any order you choose. To do this, designate the tracks in the order you want them to play.

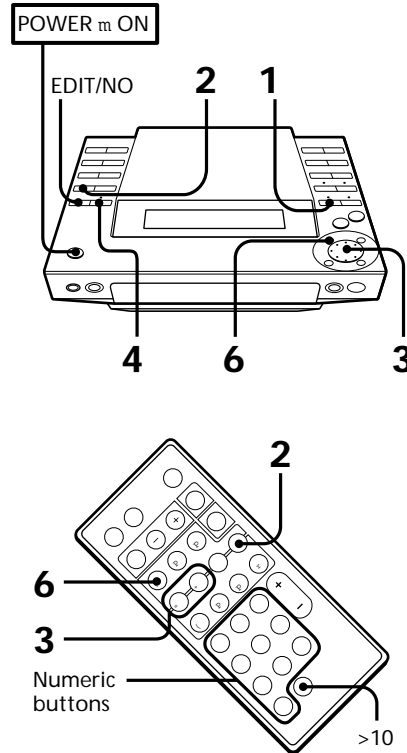

- 1 Press CD.
The unit enters CD play mode.
- 2 Press PLAY MODE (or P.MODE on the remote) repeatedly until "PROGRAM" appears in the display.
- 3 Turn the JOG dial (or press =/+ on the remote) to choose a track. The track number and the total playing time including the selected track flashes in the display. (The program is not entered at this time.)

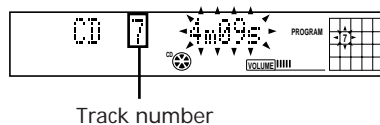
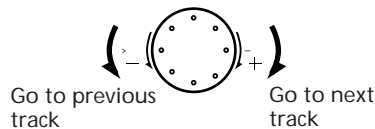

Track number

- 4 Press ENTER/YES.

The step number appears for about one second, then the total playing time appears. (This shows that the program has been entered.)

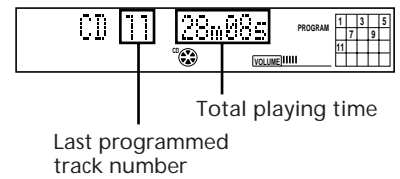

Total playing time

Last programmed track number

- 5 To program additional tracks, repeat steps 3 and 4.
- 6 Press fl.
All the tracks play in the order you choose.

To play the tracks in original order

Press PLAY MODE repeatedly until "PROGRAM" and "SHUFFLE" disappear from the display. The tracks continue playing in their original order.

To select tracks using the number buttons on the remote

In step 3, press the number buttons in the order you want to program. Each time you press a button, the track you selected is programmed.

You don't need to press ENTER/YES. To program a track with a number greater than 10, press >10 first, then enter the corresponding digits.

Example: To locate track number 30, press >10, 3, and 10 in this order.

To change the program

To	Operation
Add a track at the end of the program	1. Turn the JOG dial until the desired track number appears in the display.* 2. Press ENTER/YES.
Erase the entire program	During stop, press on the player.

* You can also add a track during playback when you select tracks with the number buttons on the remote.

Notes

- The program you made remains in memory even after it has been played back. Press fl to play the same program again.
- If "--:--" appears instead of the total playing time during programming, this means the total playing time has exceeded 100 minutes. You can still select other tracks.

Assigning a Name to a CD (disc memo function)

You can assign names to your CDs. Names may consist of uppercase and lowercase letters, numbers and symbols (up to 12 characters for each CD). You can store a maximum of 20 names in the unit. The name appears in the display when you insert a CD or press DISPLAY in stop mode. If you record the CD on a blank MD* using "CD syncro recording", the name is stored on the MD automatically.

* A brand-new MD, or an MD which has been erased using the "all erase function"

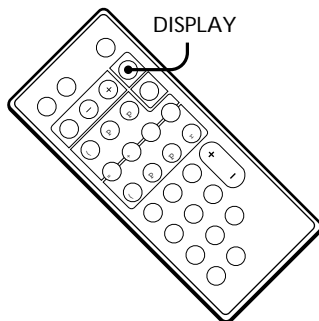
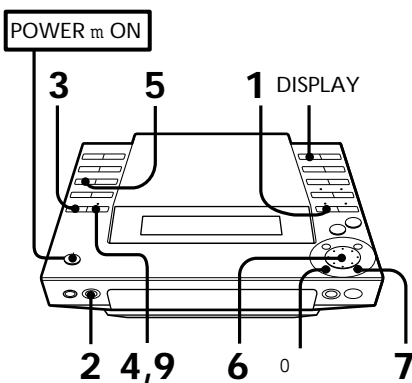

- 1 Press CD. The unit enters CD play mode.
 - 2 Press CD § and place a CD. Be sure the total number of tracks and total playing time appear in the display.
- Note**
You can assign names only when the player is in stop mode and the play mode is set to normal (SHUFFLE and PROGRAM are not lit).
- 3 Press EDIT/NO repeatedly until "Name in?" appears in the display.



- 4 Press ENTER/YES. A cursor flashes in the display.

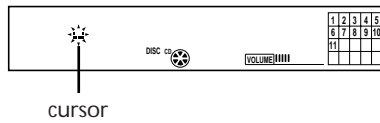

- 5 Press CHARACTER repeatedly to select the character type. Each time you press the button, the character changes as follows:

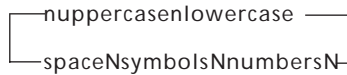

You can use the following symbols:
! " # \$ % & ' () * + , - . / : ; < = > ? @ _ ` ` ` (space)

- 6 Turn the JOG dial until the desired character appears in the display. The selected character flashes.

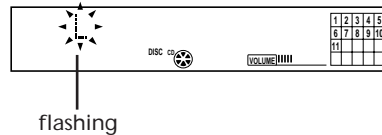

To enter a space quickly
Press) when the cursor is flashing.

- 7 Press). The cursor shifts to the right and stands by for input of the next character.

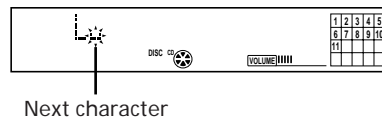

- 8 Repeat steps 5 and 7 to enter additional characters until you have entered the entire name. If you want to enter the same type of character, skip step 5.

If you entered the wrong character
Press) or 0 until the character to be corrected starts flashing, and repeat steps 5 to 7 to enter the correct character.

To erase a character
Press) or 0 until the character to be erased starts flashing, then press EDIT/NO.

- 9 Press ENTER/YES. This completes the labelling procedure.

To check the name
Press DISPLAY in stop mode. If you press DISPLAY again, the original display returns.

Note
"No name" appears in the display if you did not assign a name to the current disc.

- To delete a name**
- 1 Press EDIT/NO repeatedly until "Name Erase?" appears in the display.
 - 2 Press ENTER/YES. Disc names appear in the display.
 - 3 Turn the JOG dial until the disc name you want to erase appears in the display.
 - 4 Press ENTER/YES. "Complete" appears in the display for about two seconds and the selected disc name is erased.

Chapter 3: Playing MDs

Playing an MD (normal play)

Using the Display

Playing Tracks Repeatedly (repeat play)

Playing Tracks in Random Order (shuffle play)

Playing Tracks in the Desired Order (program play)

Playing an MD (normal play)

You can play an MD in four modes: normal, repeat, shuffle, and program. The mode decides which tracks (songs) you will listen to, in which order, and whether or not they will repeat.

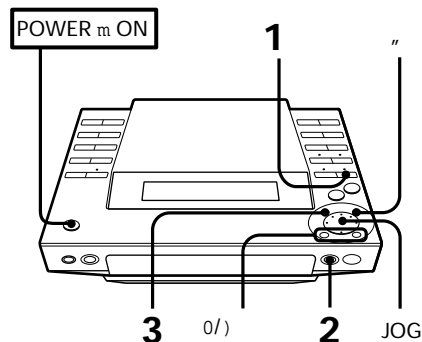

1 Press MD.
The unit enters MD play mode.

2 Press MD § and insert an MD.

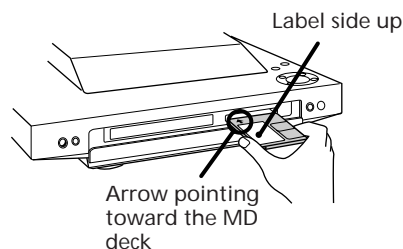

3 Press fl (or MD (on the remote).
The first track starts playing.

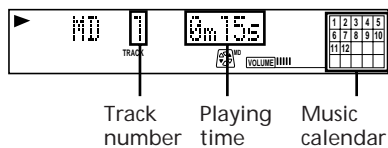

Track number Playing time Music calendar

To	Press
Stop play	(MD p*)
Pause	fl (MD P*)
Resume play	fl (MD (* or P*))
Go forward to another track	During play or pause, turn the JOG dial clockwise. Release when you reach the track you desire. Or use + on the remote.
Go back to a previous track	During play or pause, turn the JOG dial counterclockwise. Release when you reach the track you desire. Or use = on the remote.
Locate a specific track directly	Number buttons on the remote
Remove the MD	MD §

* Button on the remote

To directly locate a track numbered 11 or more

Press >10 first, then enter the corresponding digits.

If the track number is 100 or more, press >10 twice and enter the number.

Example:

To locate track number 30, press >10, 3, and 0 in this order.

To locate track number 100, press >10, >10, 1, 0 and 0 in this order.

One Touch Play feature

Press MD (on the remote when the power is off. If a MD is loaded in the player, you will be able to listen to the MD without pressing any other buttons. When you press MD on the unit, power turns on and function switches to MD automatically.

You can start playback from a desired track

1 In step 2, turn the JOG dial until the desired track number appears on the display.

2 Press fl.

continue to next page m

m continued

To find a point in a track

You can find a particular point in a track while the track is playing or while it is in pause mode. Use the buttons on the unit to operate this feature.

To	Press
Go forward quickly in a track) on the unit and release it at the desired point.
Go backwards quickly in a track	0 on the unit and release it at the desired point.
Search quickly without listening	During pause, 0 or) on the unit and release it at the desired point.

Using the Display

You can use the display on the unit to check MD and track information such as the total number of tracks, total playing time of the MD, the time remaining on the MD etc.

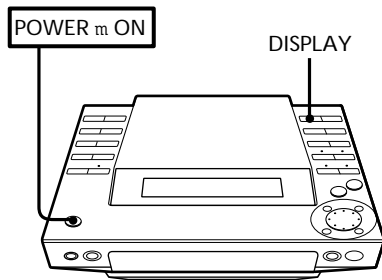

To check the remaining time during playback

Press DISPLAY repeatedly. Each time you press the button, the display changes as follows:

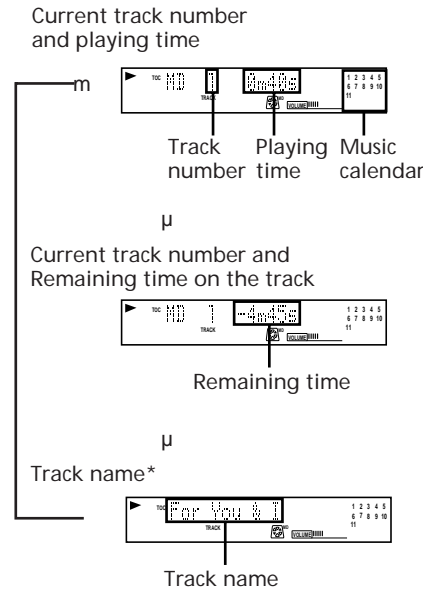

* If no title is recorded, "No Name" appears in the display.

To check the disc name, total number of tracks, total playing time and remaining recordable time

Press DISPLAY in stop mode. If you stored a name for the disc (see "Labeling Recordings (title function)"), the disc name appears on the display. Each time you press the button, the display changes as follows:

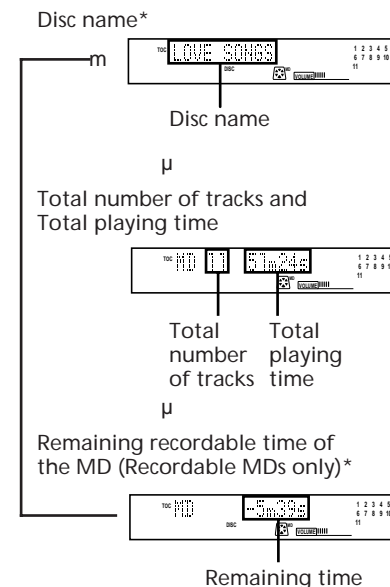

* The remaining recordable time of the disc is not shown for premastered MDs.

The Music Calendar Display

- This display lights according to the number of tracks on the MD. As each track is played, the corresponding number disappears. Tracks numbered greater than 20 are not displayed.
- When you play a premastered MD, a frame appears around the music calendar. It does not appear when you play a recordable MD.

To check the current track name while playing an MD

Press SCROLL. Press SCROLL during scrolling to pause or continue scrolling. You can put titles on your recorded MDs and tracks. See "Labeling Recordings (title function)".

Playing Tracks Repeatedly (repeat play)

You can choose between two different repeat play modes. One repeats all the tracks in the current play mode; the other repeats a single track.

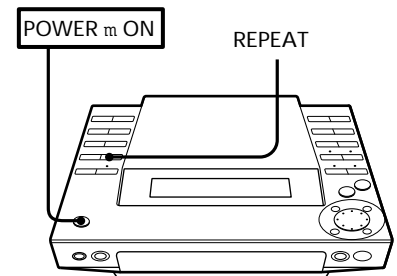

Repeating all the tracks

Press REPEAT repeatedly until "REPEAT" appears in the display.

Playing mode	Tracks played
Normal play	Repeats all the tracks on the MD.
Shuffle play	All tracks on the MD are reshuffled.
Program play	Repeats all the programs in their programmed order.

Repeating a single track (in normal play mode only)

While the desired track is being played, press REPEAT repeatedly until "REPEAT 1" appears in the display.

To cancel repeat play

Press REPEAT so that "REPEAT" or "REPEAT 1" disappears from the display.

Playing Tracks in Random Order (shuffle play)

You can play all the tracks on the MD in random order.

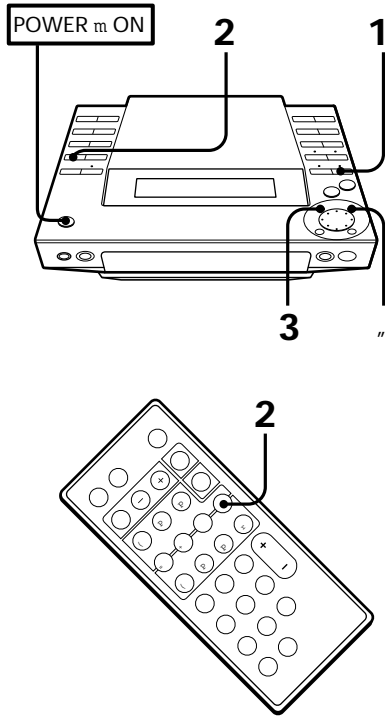

- 1 Press MD.
The unit enters MD play mode.
- 2 Press PLAY MODE (or P.MODE on the remote) repeatedly until "SHUFFLE" appears in the display.
- 3 Press fl.
"J" appears and then all the tracks play in random order.

To cancel shuffle play

Press and then press PLAY MODE repeatedly until "SHUFFLE" and "PROGRAM" disappear from the display. The tracks continue playing in their original order.

To skip an undesired track

Turn the JOG dial clockwise (or press + on the remote).

Playing Tracks in the Desired Order (program play)

You can program up to 25 tracks to play in any order you choose. You can do this by designating the tracks in the order you want them to play.

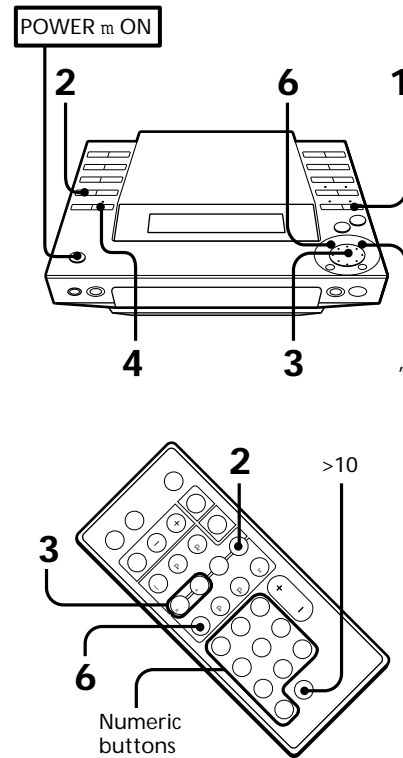

- 1 Press MD.
The unit enters MD playing mode.
- 2 Press PLAY MODE (or P.MODE on the remote) repeatedly until "PROGRAM" appears in the display.
- 3 Turn the JOG dial (or press =/+ on the remote) to choose a track.
The track number and the total playing time including the selected track appear in the display, and the track number flashes in the music calendar. (The program is not entered at this time.)

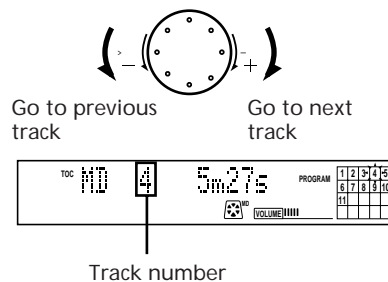

Track number

- 4 Press ENTER/YES.
The step number appears for about one second, then the total playing time appears. (This shows that the program has been entered.)

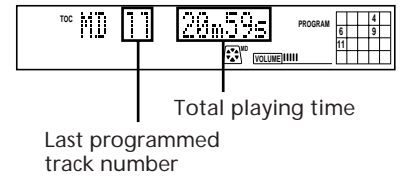

- 5 To program additional tracks, repeat steps 3 and 4.
- 6 Press fl.
All the tracks play in the order you choose.

To cancel the program play

Press and then press PLAY MODE repeatedly until "PROGRAM" and "SHUFFLE" disappears from the display. The tracks continue playing in their original order.

To select tracks using the number buttons on the remote

In step 3, press the number buttons in the order you want to program. Each time you press a button, the track you selected is programmed.

You don't need to press ENTER/YES.

To program a track with a number greater than 10, press >10 first, then enter the corresponding digits.

If the track number is 100 or more, press >10 twice and enter the number.

Example:

To locate track number 30, press >10, 3, and 10 in this order.

To locate track number 100, press >10, >10, 1, 10 and 10 in this order.

To change the program

To	Operation
Add a track at the end of the program	1. Turn the JOG dial until the desired track number appears in the display. 2. Press ENTER/YES.
Erase the entire program	During stop, press on the player.

Notes

- The program you made remains in the unit even after it has been played back. Press fl to play the same program again.
- If "--:--" appears instead of the total playing time during programming, this means the total playing time has exceeded 100 minutes. In this case, you can also select other tracks.

Chapter 4:

Recording on MDs

Before Recording

Recording a CD

Recording from the Radio

Recording on an MD Manually

Marking Track Numbers While Recording

Before Recording

MD allows you to digitally record and play back music with a sound quality similar to CD. In addition, because MDs are optical-magnetic discs, they are free from the problems of stretching or becoming tangled like ordinary cassette tapes. The recording method is also different from that of cassette tapes, because it is possible to write track numbers and edit recordings.

Digital Recording and Analog Recording

This unit uses one of the following recording methods, depending on the sound source to be recorded and how the unit is connected to the sound source.

Digital recording

When recording from this unit's CD player, the MD deck records the digital signal in the form of a digital signal.

Analog recording

In the cases listed below, the MD deck converts an analog signal into a digital signal and records the digital signal.

- When recording from this unit's Radio
- When recording from audio equipment connected to this unit's TAPE jacks

MD recording and the Serial Copy Management System

Since the MD deck uses the SCMS (Serial Copy Management System), MDs recorded from a CD played back from this unit's CD player cannot be used to make digital copies onto other MDs.

Track Marking

The way in which track numbers are written differs according to the sound source being recorded. You can also write track numbers manually.

MD track numbers (TOC)

In an MD, the track number (track sequence) and track start and end point information, etc., is recorded in an area called the "Table of Contents" (TOC) that is managed apart from the music. As a result, not only can you instantaneously find the start of a track, but you can quickly edit recorded tracks simply by changing the TOC information.

For example, with a cassette tape, erasing a track entails re-recording the track with no sound from the start. With an MD, you can delete a track simply by writing over the information in the TOC.

When recording digital signals from a CD
The MD deck automatically marks track numbers in the same sequence as the original CD.

However, if recording is paused, the portion recorded up to that point is counted as one track. When recording is started again, the track number increases by one.

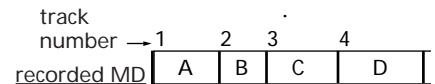
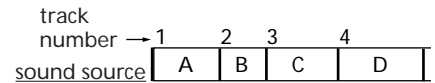

If a single track from the same CD is recorded repeatedly, the track or tracks are recorded as a single, continuous track with a single track number.

You can also mark track numbers manually during recording (see "Marking Track Numbers Manually (track marking function)").

If you select "LEVEL SYNC" during analog recording

The track number is written in sync with the level of the input signal from the sound source. In other words, if the input signal from the sound source is continuously at or below a certain fixed level for two seconds or more, a track number is written the next time the input signal exceeds that level.

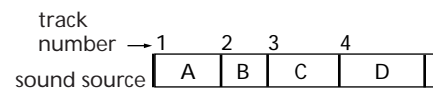

Track numbers are not written if the input signal is below the level for less than two seconds (if the blank between the two tracks is short, etc.).

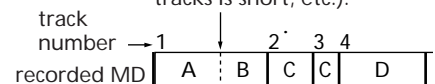

Track numbers are written during a track if the input signal is below the level for more than two seconds.

If you do not select "LEVEL SYNC" during analog recording

Only one track number is written at the start of a recording. The entire recording is counted as one track.

You can also mark track numbers manually during recording (see "Marking Track Numbers Manually (track marking function)").

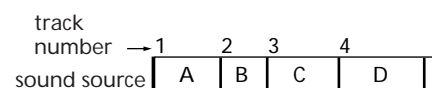

Only one track number is written at the start of the recording

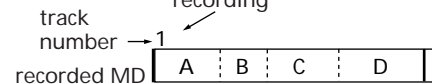

Notes on Recording

When "TOC" flashes in the display

Do not move the unit or pull out the AC power cord. The MD deck is updating the Table Of Contents (TOC).

Changes to an MD made through recording are saved only when you update the TOC by ejecting the MD or by pressing POWER to switch the MD deck to standby.

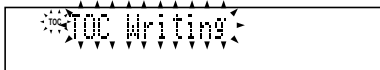

Do not disconnect the main lead immediately after recording

If you do so, the recorded sound may not be saved to the MD.

If "Auto Cut" appears in the display (auto cut)

There has been no sound input for 30 seconds while recording from a CD. The 30 seconds of silence are replaced by a blank of about 3 seconds and the MD deck changes to recording pause.

If "Smart Space" appears in the display (smart space)

There has been an extended silence of 4 to 30 seconds in length while recording from a CD. The silence is replaced with a blank of about 3 seconds and the MD deck continues recording. However, a new track number may not be written during these 3 seconds.

If "REC LEVEL OVER" appears in the display while recording from audio equipment connected to this unit's TAPE IN jacks

This message is displayed because a high-level signal was input during analog recording. If the sound is distorted, re-record the sound source again according to the following procedure.

- 1 Press EDIT/NO repeatedly during recording or recording pause until "Attenuate ?" appears in the display.
- 2 Press ENTER/YES. "Attenuate ON?" appears in the display.

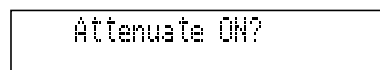

- 3 Press ENTER/YES again. The ATTENUATE indicator lights up.
- 4 Re-record the sound. The recording level is reduced.

Note

Once you change the setting, it is stored in the unit. Be sure to release this setting after recording.

To release this setting

Repeat steps 1 to 4, and confirm that "Attenuate OFF?" is displayed in step 2.

To protect the recorded sound

To make it impossible to record on an MD, slide the tab in the direction of the arrow to

open the slot. To enable recording, close the slot.

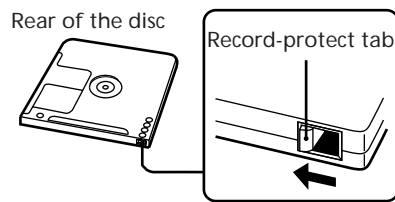

Slide the tab in the direction indicated by the arrow

Recording a CD

You can easily make digital recordings from CD on an MD (CD synchro recording), marking track numbers in the same sequence as the original CD. When you use a blank MD*, the CD name which you have stored using the "disc memo" function is also recorded on the MD automatically.

When recording additional tracks on a recordable MD, the MD deck will automatically start recording from the end of the existing sound.

* A brand-new MD, or an MD which has been erased using the "erase function".

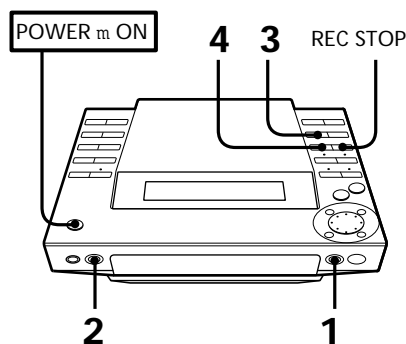

- 1 Press MD § and insert a recordable MD.

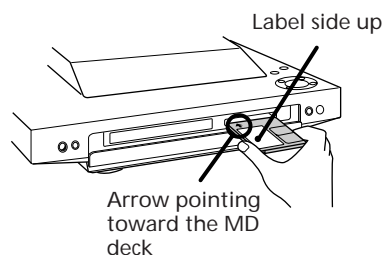

- 2 Press CD §, place a CD, then press CD § again to close the disc tray.

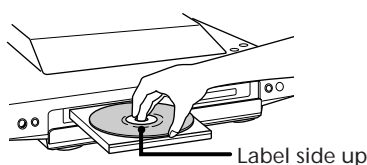

- 3 Press CD SYNCHRO

The unit enters CD play pause mode. The "REC PAUSE" indicator flashes, the MD deck stands by for recording, and the CD player stands by for playback.

- 4 Press REC PAUSE (or MD P on the remote).

The MD deck starts recording, and the CD player starts playing.

To stop recording

Press REC STOP.

When "TOC" flashes in the display

The MD deck is currently updating the Table of Contents (TOC).

Do not move the MD deck or pull out the AC power cord. Changes to an MD made through recording are saved only when you update the TOC by ejecting the MD or by pressing POWER to switch the deck to standby.

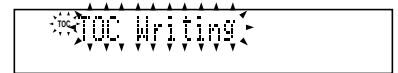

Recording from the Radio

You can record from the tuner onto an MD (analog recording).

If you use a recorded MD, the MD deck will automatically start recording from the end of the existing sound.

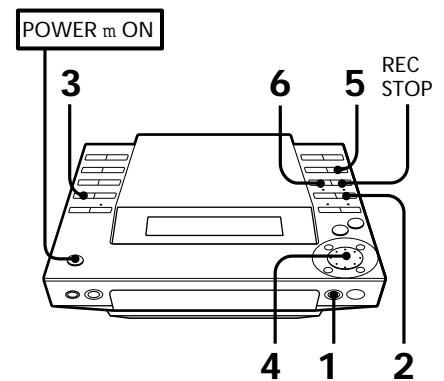

- 1 Press MD § and insert a recordable MD.

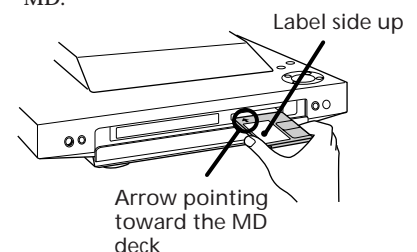

continue to next page m

m continued

2 Press TUNER/BAND repeatedly until the band you want appears in the display.

As you press this button, the band changes as follows:

FM ~ AM

3 Press TUNING repeatedly until "PRESET" appears in the display.

4 Turn the JOG dial (or press PRESET -/+ on the remote) to tune in a preset station you want to record.

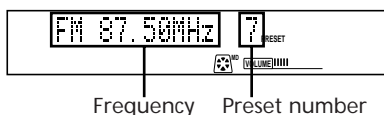
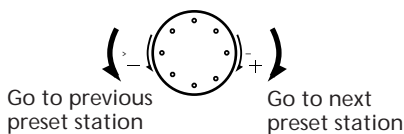

5 Press REC (or MD r REC on the remote). The REC PAUSE indicator flashes and MD deck stands by for recording.

6 Press REC PAUSE (or MD P on the remote). The MD deck starts recording.

To stop recording

Press REC STOP.

To record a station you have not stored

Press TUNING repeatedly until "MANUAL" appears in the display, and turn the JOG dial to tune in a station you want.

When you stop recording, you can start playback from the beginning of the last track that was recorded

This is a convenient way to check the contents of a recording. You might find it useful right after recording a favorite song from the radio, etc.

1 Press MD during recording.

Recording stops.

2 Press fl (or MD (on the remote) while the number of the last track flashes in the display (about 15 seconds). Playback starts from the beginning of the last track that was recorded.

Recording on an MD Manually

When recording additional tracks on a recordable MD, the MD deck will automatically start recording from the end of the existing sound.

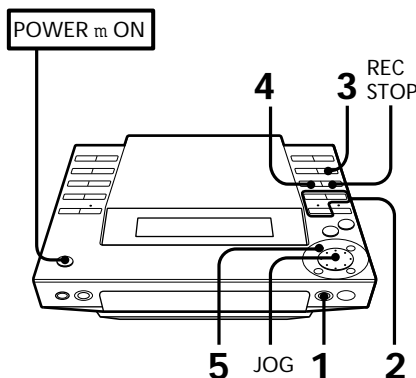

1 Press MD § and insert a recordable MD.

2 Press one of the FUNCTION buttons (TAPE, TUNER/BAND or CD) on the unit to select a sound source you want to record (or press FUNCTION repeatedly on the remote).

3 Press REC (or MD r REC on the remote). The REC PAUSE indicator flashes and the MD deck stands by for recording. When recording from CD, track numbers will be written automatically in the same sequence as the CD. When recording from a source other than CD, see "Marking Track Numbers Automatically" in order to write track numbers automatically.

4 Press REC PAUSE (or MD P on the remote). The MD deck starts recording.

5 Start playing the sound source.

To	Press
Pause recording*	REC PAUSE (or MD P on the remote)
Resume recording	REC PAUSE (or MD P on the remote)
Stop recording	REC STOP

* Whenever you pause recording, the track number increases by one. For example, if you paused recording while recording on track 4, the track number increases by one and recording continues on the new track when restarted.

When you stop recording, you can start playback from the beginning of the last track that was recorded

This is a convenient way to check the contents of a recording. You might find it useful right after recording a favorite song from the radio, etc.

1 Press MD during recording.

Recording stops.

2 Press fl (or MD (on the remote) while the number of the last track flashes in the display (about 15 seconds).

Playback starts from the beginning of the last track that was recorded.

Marking Track Numbers While Recording

The way in which track numbers are written differs according to the sound source being recorded. See "Track Marking" for details.

Marking Track Numbers Manually (track marking function)

You can mark a track number at any time while recording on an MD, no matter what sound source you selected.

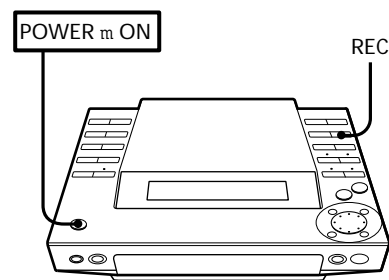

Press REC (or MD r REC on the remote) at the place you want to add a track mark while recording.

Note

If you decide the track number mark is unnecessary, or the location is incorrect, you can use the combine function to undo the mark (see "Combining Recorded Tracks (combine function)").

Marking Track Numbers Automatically (level synchro function)

You can mark track numbers automatically even when recording from an analog source. The MD deck marks a new track number if the signal level is continuously at or below a certain fixed level for 2 seconds or more, and then exceeds that level.

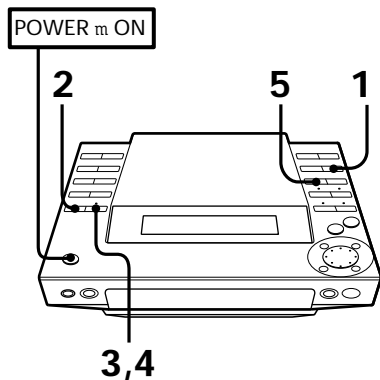

- 1** Press REC (or MD r REC on the remote).
The REC PAUSE indicator flashes and the MD deck stands by for recording.
- 2** Press EDIT/NO repeatedly until "LevelSync?" appears in the display
- 3** Press ENTER/YES.
"LevelSync ON?" appears in the display.



- 4** Press ENTER/YES.
"LEVEL-SYNC" appears in the display.
- 5** Starts recording.

Note

This setting is stored in the unit. Release it after recording.

To cancel level synchro

- 1** Press EDIT/NO until "LevelSync?" appears during recording or recording pause.
- 2** Press ENTER/YES.
"LevelSyncOFF?" appears in the display.
- 3** Press EDIT/YES.
"LEVEL-SYNC" disappears in the display.

Chapter 5: Editing Recorded MDs

Erasing Recordings (erase function)

Moving Recorded Tracks (move function)

Dividing Recorded Tracks (divide function)

Combining Recorded Tracks (combine function)

Labeling Recordings (title function)

Erasing Recordings (erase function)

You can erase the recorded sound easily. Since erasing updates the TOC, you do not have to record over previous material. You can choose from the following three erase methods:

- Erasing a single track
- Erasing all tracks
- Erasing parts of a track

When erasing two or more tracks

When you erase a track, all tracks following the erased one are renumbered. For example, if you erase track 1, the original track 2 will be renumbered as track 1. To avoid confusion, you should erase starting from high track numbers and proceeding to low track numbers. This prevents renumbering of tracks that have not yet been erased.

Erasing a single track

You can erase a track simply by specifying its track number. When you erase the track, the total number of tracks on the MD decreases by one and all tracks following the erased one are renumbered.

Example: Erasing B

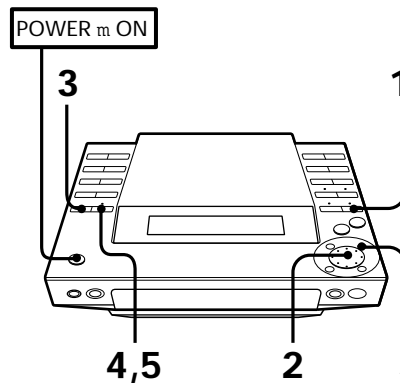
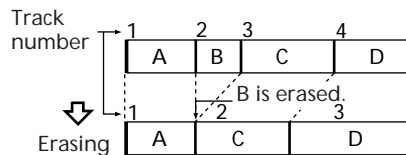

- 1 Press MD.
The unit enters MD play mode.

- 2 Turn the JOG dial to select the track number you want to erase.

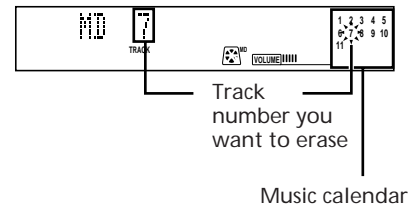

- 3 Press EDIT/NO repeatedly until "Erase ?" appears in the display.



- 4 Press ENTER/YES.
"Erase ??" appears in the display.



- 5 Press ENTER/YES again.
"Complete" appears in the display for a few seconds and the track selected in step 2 is erased.

- 6 Repeat steps 2 to 5 to erase more tracks.

To stop before the track has been erased

Press .

If "Erase!! ?" appears in the display

The track was recorded or edited on another MD deck and is record-protected. If you still want to erase the track, press ENTER/YES while this indication is displayed.

Erasing all tracks

You can easily create a blank MD. You can erase all recorded tracks, titles and names at the same time.

Note that once erased, MD data cannot be recovered.

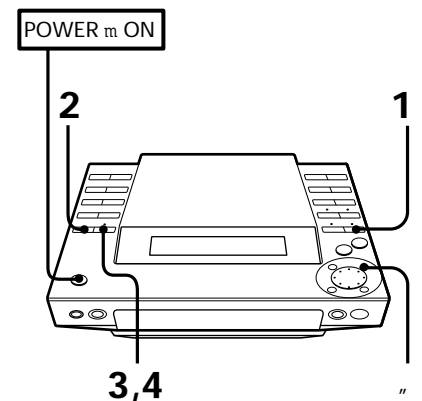

- 1 Press MD.
The unit enters MD play mode.
- 2 Press EDIT/NO repeatedly until "All Erase?" appears in the display in stop mode.
- 3 Press ENTER/YES.
"All Erase??" appears in the display.
- 4 Press ENTER/YES again.
When all recorded tracks, the disc name, and titles on the MD have been erased, "Complete" appears for a few seconds.

To stop before all tracks, the disc name, and titles have been erased Press .

Erasing part of a track

By using the divide, erase, and combine functions, you can erase specific portions of a track.

Example: Erasing a part of track A

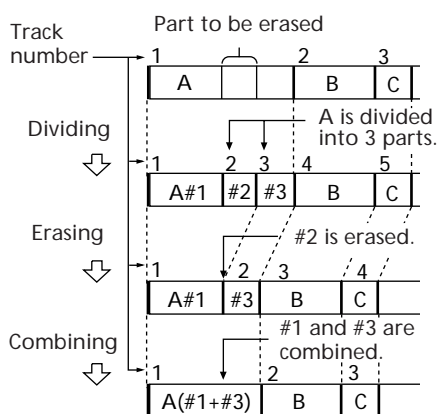

Moving Recorded Tracks (move function)

You can change the position of any track. After you move a track, the tracks between the new and old track positions are automatically renumbered.

Example: Moving C to track position 2

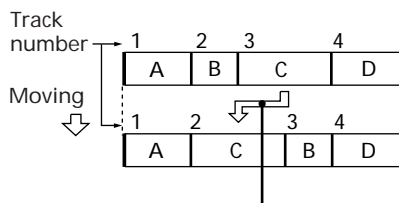

Track C moves to track position 2.

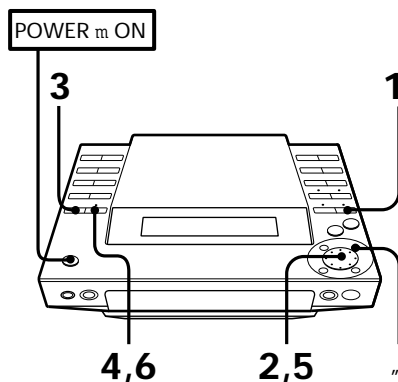

- 1 Press MD.
The unit enters MD play mode.
- 2 Turn the JOG dial until the track number you want to move appears in the display.
For example, if you want to move 7th track to 1st, turn the JOG dial until 7th track appears in the display.

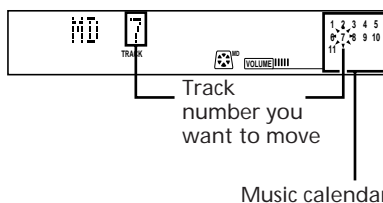

- 3 Press EDIT/NO repeatedly until "Move ?" appears in the display.
- 4 Press ENTER/YES.
- 5 Turn the JOG dial until the new track number appears.

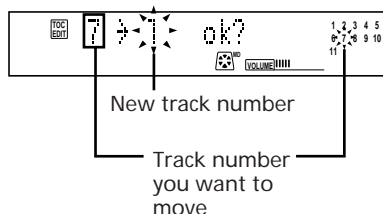

- 6 Press ENTER/YES.
After you have moved the track, "Complete" appears for a few seconds.

To stop before the track has been moved Press .

Dividing Recorded Tracks (divide function)

In the following cases, you can divide a track into two or more tracks and put new track numbers for searching particular points of the tracks.

- When you recorded from an analog source and therefore the MD contains only one track number
- When you want to put markings in a track to find particular points

After you divide a track

The total number of tracks on the MD increases by one and all tracks following the divided track are renumbered.

Example: Dividing track 2 to create a new track for C

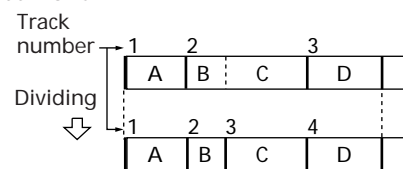

Track 2 is divided, creating a separate track for C, and all the following tracks are renumbered.

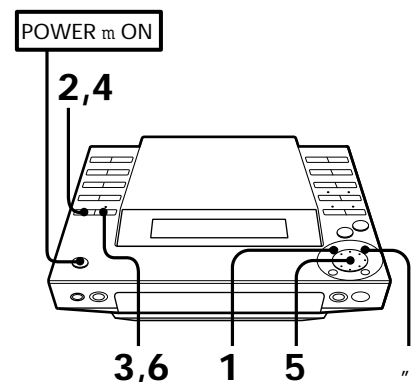

- 1 While playing the MD, press fl at the point where you want to create a new track.
The deck pauses playing.
- 2 Press EDIT/NO repeatedly until "Divide ?" appears in the display.
- 3 Press ENTER/YES.
"Rehearsal" alternates with "Position ok?" in the display, and the starting portion of the new track begins playing repeatedly.

continue to next page m

m continued

- 4** If the starting position is incorrect, press EDIT/NO.
If it is correct, go to step 6.



Playing track number flashes

- 5** While monitoring the sound, turn the JOG dial to find the starting position of the new track.
The starting portion of the new track is played back repeatedly.
The starting position can be moved within a maximum range of -128 to +127 steps (of about 0.06 second each) within a track.

- 6** Press ENTER/YES when the position is correct.
When the track has been divided, "Complete" appears for a few seconds and the newly created track begins playing. The new track will have no track title even if the original track was labeled.

To stop before the track has been divided
Press .

You can undo a track division

Combine the tracks again, then redivide the tracks if necessary.

You can divide a track while recording
Use the track marking function.

Combining Recorded Tracks (combine function)

You can combine two consecutive tracks into one. This function is useful for combining several songs into a single medley, or several independently recorded portions into a single track.

After you combine two tracks

The total number of tracks decreases by one and all tracks following the combined tracks are renumbered.

Example: Combining B and C

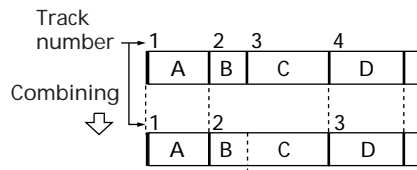

B and C are combined into one track.

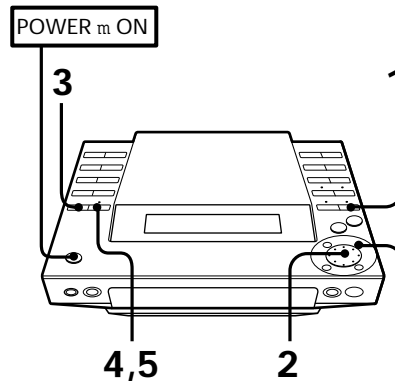

- 1** Press MD.
The unit enters MD play mode.
- 2** Turn the JOG dial until the second track of the two to be combined appears.
For example, when combining tracks 3 and 4, turn the JOG dial until 4 appears.

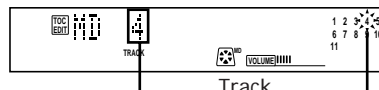

Track number you want to combine

- 3** Press EDIT/NO repeatedly until "Combine?" appears in the display.
- 4** Press ENTER/YES.
"Rehearsal" alternates with "Track ok?" in the display. The place where the two tracks will join (i.e., the end of the first track and the beginning of the second track) repeatedly plays back.
- 5** Press ENTER/YES when the position is correct.
When the tracks have been combined, "Complete" appears for a few seconds. If both of the combined tracks have track titles, the title of the second track is erased.

To stop before the tracks have been combined
Press .

You can undo a track combination

Divide the tracks again, then repeat the combine function with the correct tracks if necessary.

If "Sorry" appears in the display

The tracks cannot be combined. This sometimes happens when you have edited the same track many times. This is due to a technical limitation of the MD system, not a mechanical error.

Labeling Recordings (title function)

You can put titles on your recorded MDs and tracks.

Titles may consist of uppercase and lowercase letters, numbers and symbols for a maximum of 80 characters for each titles per a disc.

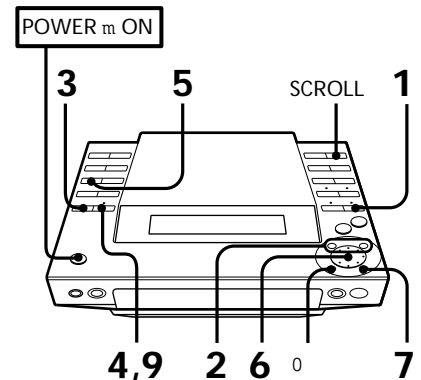

- 1** Press MD.
The unit enters MD play mode.
- 2** When you want to title the disc, press so that the deck stops playback.
When you want to title a track, press fl while playing the track you want to title so that the deck pauses playback.

You can title a track during playback or recording. You can also title tracks without pausing, but if you don't finish entering the title before the track ends, the title will be erased.

- 3** Press EDIT/NO repeatedly until "Name in?" appears in the display.
- 4** Press ENTER/YES.
A cursor flashes in the display.

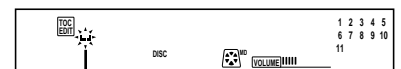

cursor

- 5** Press CHARACTER repeatedly to select the character type.
Each time you press, the character changes as follows:

npppercasenlowercase
spaceNsymbolsNnumbersN

You can use the following symbols:
! " # \$ % & ' () * + , - . / : ; < = > ? @ _ ` (space)

- 6** Turn the JOG dial until the desired character appears in the display.
The selected character flashes.



To enter a space quickly

Press) while the cursor is flashing.

- 7** Press).
The cursor shifts rightward and stands by for the input of the next character.

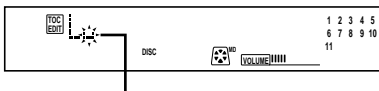

Next character

- 8** Repeat steps 5 and 7 until you have entered the entire title.
If you want to enter the same type of character, skip step 5.

If you entered the wrong character

Press) or 0 until the character to be corrected starts flashing, and repeat steps 5 to 7 to enter the correct character.

To erase a character

Press) or 0 until the character to be erased starts flashing, then press EDIT/NO.

- 9** Press ENTER/YES.
This completes the labelling procedure and the title scrolls in the display.

To stop before the track has been labelled

Press .

To check the titles

You can check the disc or track name by pressing SCROLL.

To check the	Press SCROLL*
Disc name	While the deck is stopped
Track name	While the deck is playing

* Press SCROLL again to pause, and once more to continue scrolling.

To delete the title of the disc and the titles of all of the tracks (name erase function)

You can erase all titles on an MD simultaneously.

Note that once erased, titles cannot be recovered. If you want to stop deleting, press .

- 1 While the deck is stopped, press EDIT/NO repeatedly until "Name Erase?" appears in the display.
- 2 Press ENTER/YES.
"Name Erase ??" appears in the display.
- 3 Press ENTER/YES again.
All titles are erased.

Chapter 6: the Radio

Listening to the Radio

Presetting Radio Stations

Playing Preset Radio Stations

Listening to the Radio

You can have the tuner automatically scan and tune in the stations with clear signals. This feature saves you time in searching for stations with clear signals. However, you will have to manually tune in the stations with weak signals that are skipped by automatic tuning.

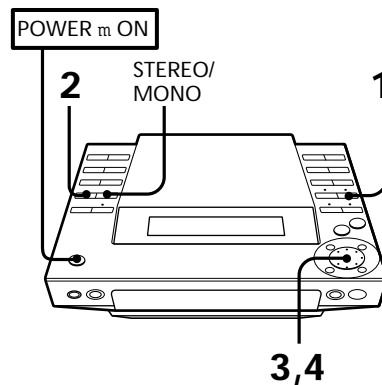

- 1 Press TUNER/BAND (or BAND on the remote) repeatedly until the band you want appears in the display. Each time you press this button, the band changes as follows:

FM ~ AM



Receiving frequency

- 2 Press TUNING repeatedly until "AUTO" appears in the display.



- 3 Turn the JOG dial clockwise to scan a higher frequency station. To tune in a lower frequency station, turn the JOG dial counter-clockwise. The tuner starts scanning radio frequencies, and stops automatically when it finds a clear station.

"TUNED" appears in the display. "STEREO" also appears if the tuned FM station is broadcasting in stereo.

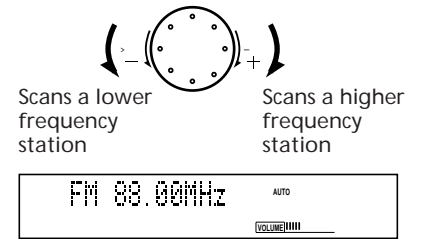

- 4 If you do not want to listen to the station selected, turn the JOG dial again to restart the scan.

When the desired station is not tuned in

Automatic tuning may skip stations with a weak signals. Tune in the station manually.

- 1 Press TUNING repeatedly until "MANUAL" appears in the display.
- 2 Keep turning the JOG dial until the desired station is tuned in.

To improve AM broadcast reception
Reorient the supplied AM loop antenna for AM.

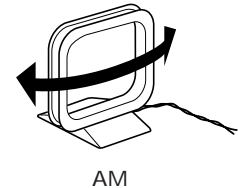

When an FM program is not received clearly
Press STEREO/MONO so that "MONO" appears in the display. There will be no stereo effect, but the reception will improve. Press STEREO/MONO again to restore the stereo effect.

One Touch Play feature

Press BAND on the remote when the power is off. You will be able to listen to the last received station without pressing any other buttons.

When you press TUNER/BAND on the unit, power turns on and function switches to TUNER automatically.

Presetting Radio Stations

You can store radio frequencies in the tuner's memory to tune in your favorite stations quickly. You can preset up to 20 FM stations and 10 AM stations in any order.

Use the buttons on the unit for presetting stations.

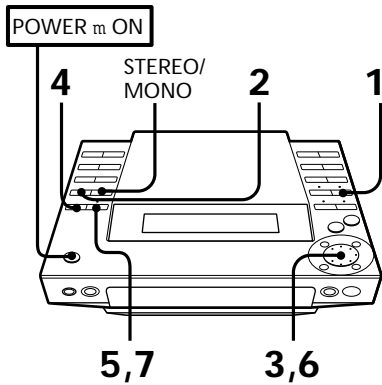

- 1 Press TUNER/BAND (or BAND on the remote) repeatedly until the band you want appears in the display. Each time you press this button, the band changes as follows:

FM ~ AM

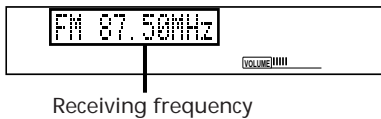

- 2 Press TUNING repeatedly until "AUTO" appears in the display.



- 3 Turn the JOG dial clockwise to scan a higher frequency station. To tune in a lower frequency station, turn the JOG dial counter-clockwise. The tuner starts scanning radio frequencies, and stops automatically when it finds a clear station. "TUNED" appears in the display. "STEREO" also appears if the tuned FM station is broadcasting in stereo.

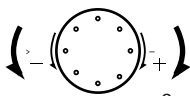

Scans a lower frequency station

Scans a higher frequency station

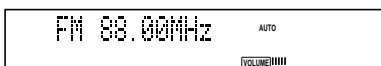

When the desired station is not tuned in Automatic tuning may skip stations with a weak signals. Tune in the station manually.

- 1 Press TUNING repeatedly until "MANUAL" appears in the display.
- 2 Keep turning the JOG dial until the desired station is tuned in.
- 4 Press EDIT/NO repeatedly until "Frq-Memory ?" appears in the display.



- 5 Press ENTER/YES.

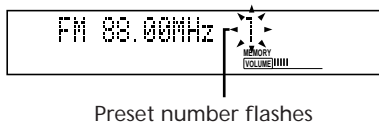

- 6 Turn the JOG dial to select a preset channel number.
- 7 Press ENTER/YES. The station is stored at the preset number you selected.

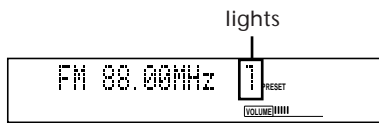

- 8 Repeat steps 1 to 7 for each station you want to store.

To change the preset number
Start again from step 1.

When an FM program is not received clearly Press STEREO/MONO so that "MONO" appears in the display. There will be no stereo effect, but the reception will improve. Press STEREO/MONO again to restore the stereo effect.

Assigning a Name for a Preset Station (station name)

You can assign a name consisting of up to ten character for each preset station. Names may consist of uppercase and lowercase letters, numbers and symbols. The station name appears in the display when you tune the preset station. If you record the preset station on an MD using timer recording function, the name will be stored on the MD automatically.

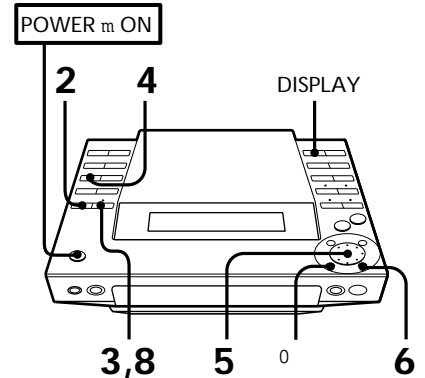

- 1 Tune in the preset station you would like to assign a name.
- 2 Press EDIT/NO repeatedly until "Name in?" appears in the display.

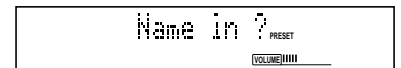

- 3 Press ENTER/YES. A cursor flashes in the display.

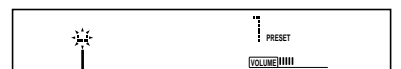

Cursor flashes

- 4 Press CHARACTER repeatedly to select character type. Each time you press this button, the character changes as follows:

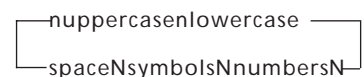

You can use the following symbols:
! " # \$ % & ' () * + , - . / : ; < = > ? @ _ ` (space)

continue to next page →

→continued

- 5** Turn the JOG dial until the desired character appears in the display. The selected character flashes.

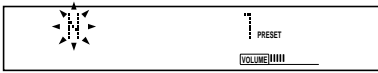

To enter a space quickly

Press) while the cursor is flashing.

- 6** Press). The cursor shifts rightward and stands by for the input of the next character.

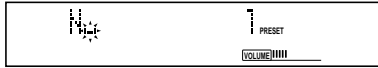

- 7** Repeat steps 4 and 6 until you have entered the entire title. If you want to enter the same character, skip step 4.

If you entered the wrong character

Press) or 0 until the character to be corrected starts flashing, and repeat steps 4 to 6 to enter the correct character.

To erase a character

Press) or 0 until the character to be erased starts flashing, then press EDIT/NO.

- 8** Press ENTER/YES. This completes the assigning procedure and the name appears in the display.

To erase the station name

You can erase the station name by changing all the characters of that name into "spaces".

To change the display

Press DISPLAY.

Each time you press the button, the frequency or station name (if you have stored one) appears in the display repeatedly.

Playing Preset Radio Stations

Once you have preset the stations, use the JOG dial to quickly tune in your favorite stations.

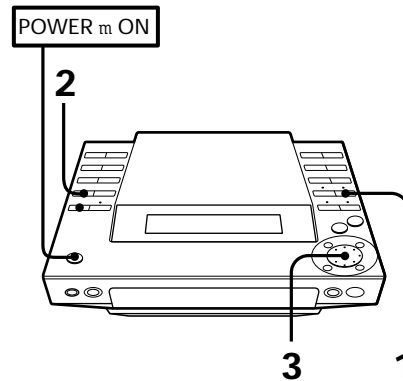

- 1** Press TUNER/BAND repeatedly to select the band you want.

FM ~ AM

- 2** Press TUNING so that "PRESET" appears in the display.

- 3** Turn the JOG dial (or press PRESET (-/+) on the remote) to tune in a preset station.

The station frequency appears and the system begins receiving the stations.

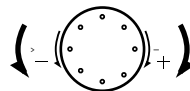

Go to previous preset station

Go to next preset station

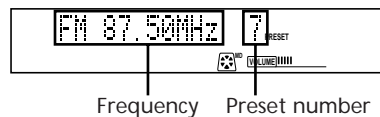

To select a station directly

After step 1 above, you can quickly tune in your favorite stations preset on channel numbers 1 to 10 by pressing the corresponding numeric buttons.

When you select channel numbers greater than 10, press >10 first, then enter the corresponding digits.

Example:

To select channel number 25, press >10, 2 and 5 in this order.

Chapter 7: Sound Adjustment

Adjusting the Sound

Adjusting the Sound

To fully enjoy the sound coming from your stereo system, make the following audio adjustments.

You can also use the remote to do this operation.

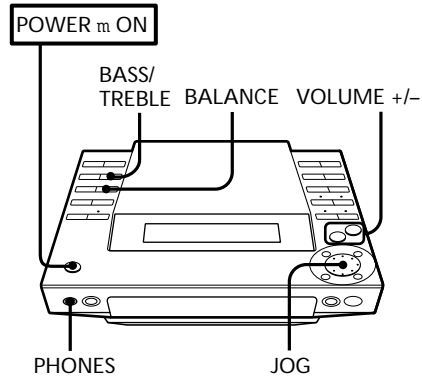

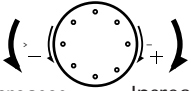
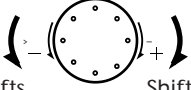
To adjust	Do this
the volume	<p>Increasing the volume, press VOLUME + (or VOL + on the remote)</p> <p>Decreasing the volume, press VOLUME - (or VOL - on the remote)</p>
the bass or treble sound	<p>1 Press BASS/TREBLE to select the sound tone you want to adjust. Each time you press this button, the tone changes as follows:</p> <p>BASSnTREBLEnOFF</p> <p>└──────────┘</p> <p>2 Turn the JOG dial to adjust the tone</p>  <p>Decreases bass/treble sound Increases bass/treble sound</p>
the balance	<p>Press BALANCE and turn the JOG dial to adjust the balance</p>  <p>Shifts sound to the left Shifts sound to the right</p>

To listen through the headphones
Connect the headphones to PHONES jack. No sound will come from the speakers.

Chapter 8:

Additional Features

Falling Asleep to Music

Waking Up to Music

Timer-Recording Radio Programs

Connecting Optional Equipment

Falling Asleep to Music

You can set the stereo system to turn off automatically so you can go to sleep to music (sleep timer).

Before setting the sleep timer, make sure the clock has been set correctly.

You can set the sleep timer even if you have already set the wake-up timer.

Use the button on the remote for this operation.

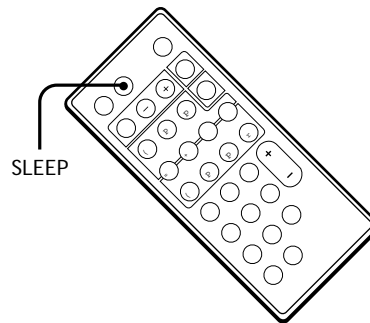

- 1 Play your favorite sound source (a tape, the tuner or a CD).
- 2 Press SLEEP repeatedly to choose how long you want the music to play. The sleep time indication appears in the display.

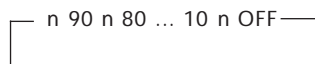

The minute indication sets the timer to turn the power off after 90 to 10 minutes in ten minute intervals.

To cancel the sleep timer

Press SLEEP repeatedly until "OFF" appears in the display.

To check the remaining time before the sleep timer turns off the system

Press SLEEP once. The remaining time (in minutes) is displayed for several seconds.

To change the remaining time while the sleep timer is on

Press SLEEP repeatedly to select the remaining time you desire.

Waking Up to Music

You can wake up to music at a preset time. You only need to set the timer once. The timer will remain activated until you reset it or disconnect the main leads.

Before setting the timer, make sure the clock has been set correctly.

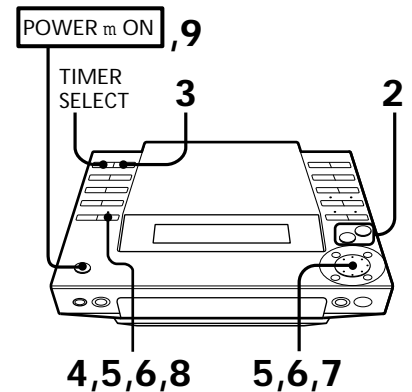

- 1 Prepare the sound source.

To wake up to the radio

Tune in the preset station you want.

To wake up to a CD

Insert a CD. If you want it to play from a specific track, do the necessary procedures for programmed CD play (see "Playing Tracks in the Desired Order (program play)").

To wake up to a MD

Insert a MD.

- 2 Press VOLUME +/- to adjust the volume. After you finish adjusting, stop playing CD or MD.
- 3 Press TIMER SET repeatedly until "DAILY TIMER ?" appears in the display.



- 4 Press ENTER/YES. "ON" appears and hour digits flash in the display.
- 5 Set the time you want the system to turn on.
 - 1 Use the JOG dial to set the hour.

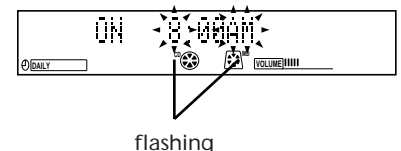

flashing

- 2 Press ENTER/YES.
The minutes digits flash in the display.



flashing

- 3 Use the JOG dial to set the minutes.



flashing

- 4 Press ENTER/YES.
"OFF" appears and the hour digits flash in the display.



flashing

- 6 Set the time you want the system to turn off in the same way.

- 7 Use the JOG dial to select a sound source.
The display changes as follows:



- 8 Press ENTER/YES.
The preset items appear in the display sequentially.

- 9 Press POWER to turn off the system.
About 15 seconds before the preset time, the power will go on at the preset time and the music will play. At the turn-off time, the power will go off again.

To cancel the timer

Press TIMER SELECT repeatedly until "TIMER OFF" appears in the display.

To change the timer

Repeat all above procedure from step 1.

You can check the preset items

Press TIMER SELECT repeatedly until "DAILY" appears in the display again. Preset items appear in the display.

Timer-Recording Radio Programs

You can set the timer to record from the radio at a certain time. This timer works only once for each setting. The volume level is automatically set to MIN.

If you record from a preset station you have assigned a name, the name, on time and off time are stored on the MD automatically.

- Preset the station you want to record.
- Make sure the clock has been set correctly.

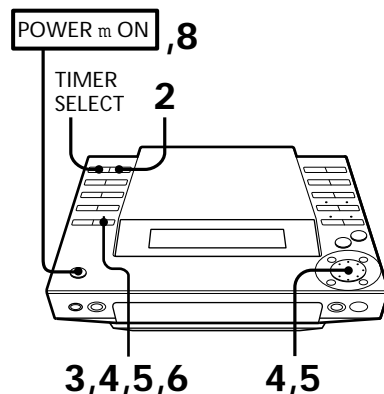

- 1 Tune the preset station you want to record.

- 2 Press TIMER SET repeatedly until the "REC TIMER ?" appears in the display.



- 3 Press ENTER/YES.
"REC" appears and hour digits flash in the display.

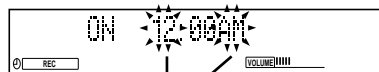

flashing

- 4 Set the time you want the system to start recording.

- 1 Use the JOG dial to set the hour.



flashing

- 2 Press ENTER/YES.
The minutes digits flash in the display.



flashing

- 3 Use the JOG dial to set the minutes.



flashing

- 4 Press ENTER/YES.
"OFF" appears and the hour digits flash in the display.



flashing

- 5 Set the time you want the system to turn off in the same way.

- 6 Press ENTER/YES.
The preset items appear in the display sequentially.

- 7 Insert a recordable MD.
"TOC Reading" appears in the display for a few seconds and the MD deck reads the contents of the MD.

- 8 After "TOC Reading" disappears from the display, press POWER to turn off the system.

About 15 seconds before the preset time, the power turns on and the volume level is automatically set to the MIN.

Notes

- Do not turn off the power while "TOC Reading" appears in the display. The timer operation may not be performed correctly.
- If you use a brand new MD, nothing is recorded for the first 15 seconds.

To cancel the timer

Press TIMER SELECT repeatedly until "TIMER OFF" appears in the display.

To change the timer

Repeat all above procedure from step 1.

You can check the preset items

Press TIMER SELECT repeatedly until "REC" appears in the display again. Preset items appear in the display.

Connecting Optional Equipment

For greater enjoyment of your stereo system, you can connect a stereo cassette deck to the stereo. You can record from sound sources of the system into the cassette deck.

Connecting a stereo cassette deck

Use audio cords and make sure to connect the plugs to jacks of the same colour. See the instruction manual of the stereo cassette deck for details.

Connect	With
LINE IN jacks of the cassette deck	TAPE OUT jacks
LINE OUT jacks of the cassette deck	TAPE IN jacks

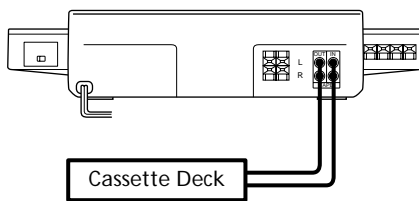

To listen to the sound from the cassette deck
Press TAPE.

For Your Information

Precautions

Maintenance

Guide to the Serial Copy Management System

System Limitations of MD

MD Display Messages

Troubleshooting Guide

Specifications

Index to Parts and Controls

Index

Precautions

If you have any questions or problems concerning your stereo system, please consult your nearest Sony dealer.

On safety

- The use of optical instruments with this product will increase eye hazard.
- The unit is not disconnected from the AC power source (mains) as long as it is connected to the wall outlet, even if the unit itself has been turned off.
- Unplug the system from the AC power outlet if it is not to be used for an extended period of time. To disconnect the AC power cord, pull it out by the plug. Never pull the cord itself.
- Should any solid object or liquid fall into a component, unplug the stereo system and have the component checked by qualified personnel before operating it any further.
- AC power cord must be changed only at the qualified service shop.

On installation

Place the stereo system in a location with adequate ventilation to prevent heat build-up in the stereo system.

On condensation in the CD player and the MD deck component

If the system is brought directly from a cold to a warm location, or is placed in a very damp room, moisture may condense on the lens inside the CD player or the MD deck. Should this occur, the CD player or the MD deck will not operate. Remove the CD or the MD and leave the system turned on for about an hour until the moisture evaporates.

Notes on handling MDs

Because the MD itself is housed in a cartridge, you can handle it normally without being concerned about dirt or fingerprints. However, malfunctioning may result if the cartridge itself is dirty or warped.

Do not open the shutter on the MD cartridge

Trying to force the shutter open will damage the shutter.

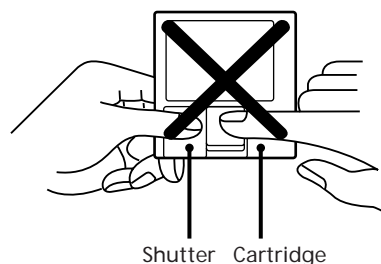

In case colour irregularity is observed on a nearby TV screen

With this magnetically shielded type of speaker system, the speakers can be installed near a TV set. However, colour irregularity may still be observed on the TV screen depending on the type of your TV set.

If colour irregularity is observed...

Turn off the TV set once, then turn it on after 15 to 30 minutes.

If colour irregularity is observed again...

Place the speakers farther away from the TV set.

Maintenance

To clean the cabinet

Use a soft cloth slightly moistened with mild detergent solution.

To clean the CD

When a CD is dirty, clean it with a cleaning cloth. Wipe the CD from the center out.

Notes on CD

- Do not use solvents such as benzene, thinner, commercially available cleaners, or anti-static spray intended for vinyl LPs.
- If there is a scratch, dirt or fingerprints on the CD, it may cause a tracking error.

Notes on MD

- Do not expose the MD to direct sunlight or heat sources such as hot air ducts, nor leave it in a car parked in direct sunlight as there can be a considerable rise in temperature inside the car.
- Periodically remove dust and debris from the cartridge surface by wiping it with a dry cloth.

Guide to the Serial Copy Management System

An MD recorded through a digital input cannot be used to make another recording with digital input. As a digital audio component, this MD deck conforms with the Serial Copy Management System standards. The Serial Copy Management System restricts copies made by recording digital signals to first-generation copies only.

However, subsequent recording from the first-generation copy onto another recordable DAT tape or MD is possible through the analog input jack on the DAT or MD deck.

There are three general rules that apply to this unit.

Rule 1

You can record from digital program sources (CDs, DATs or premastered MDs) onto a DAT tape or recordable MD via the digital input jack on a DAT or MD deck. You cannot, however, record from this recorded DAT tape or MD onto another DAT tape or recordable MD via a digital input jack on the DAT or MD deck.

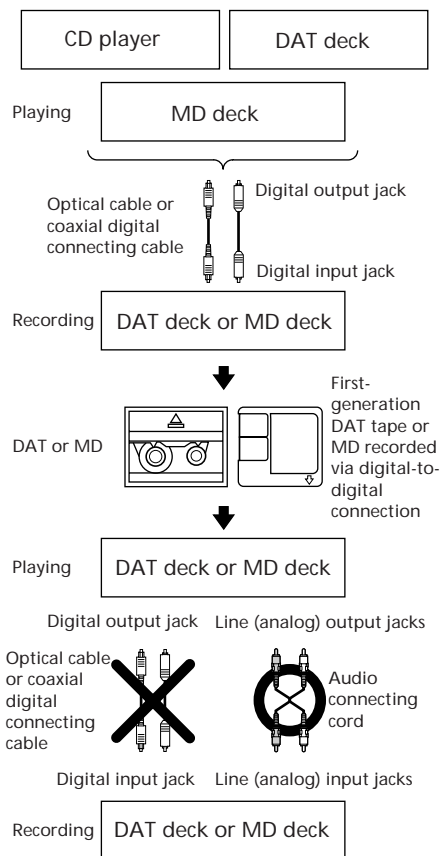

Rule 2

You can record a digital signal input from a digital satellite broadcast onto a DAT tape or recordable MD via the digital input jack on the DAT or MD deck which is capable of handling a sampling frequency of 32 kHz or 48 kHz. (This unit supports 44.1 kHz only.)

You can then record the contents of this recorded DAT tape or MD (first-generation) onto another DAT tape or recordable MD via digital input jack on the DAT or MD deck to create a second-generation digital copy. Note, however, that on some BS tuners, second-generation digital copying may not be possible.

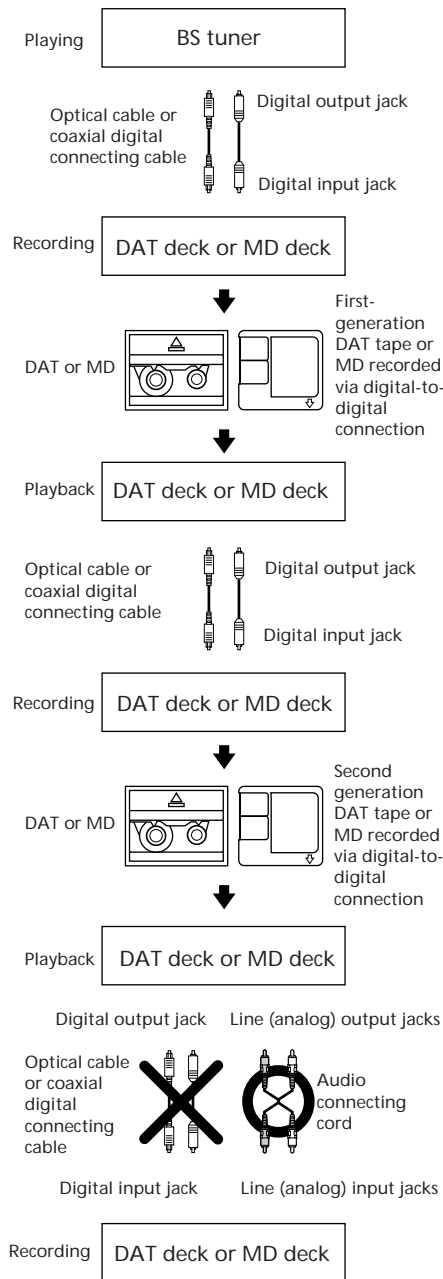

Rule 3

You can record a DAT tape or MD recorded via the DAT or MD deck's analog input jack onto another DAT tape or MD via the DAT or MD deck's digital output jack. You cannot, however, make a second-generation DAT tape or MD copy via the DAT or MD deck's digital output jack.

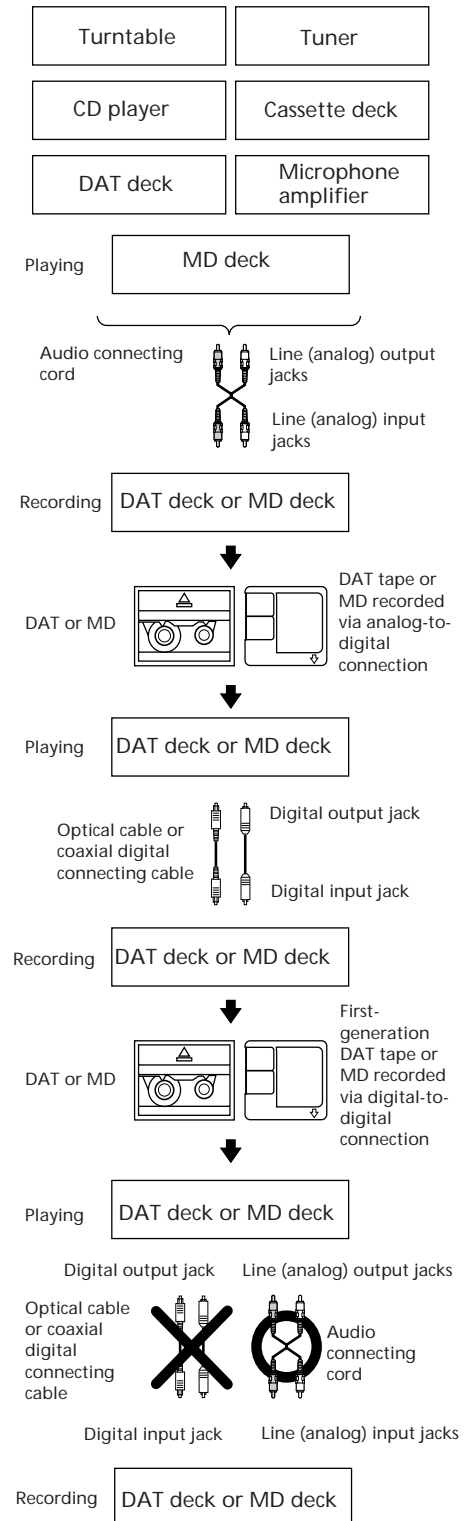

System Limitations of MD

The recording system in your MD deck is radically different from those used in cassette and DAT decks and is characterized by the limitations described below. Note, however, that these limitations are due to the inherent nature of the MD recording system itself and not to mechanical causes.

"Disc Full" lights up even before the MD has reached the maximum recording time (60 or 74 minutes)

When 255 tracks have been recorded on the MD, "Disc Full" lights up regardless of the total recorded time. More than 255 tracks cannot be recorded on the MD. To continue recording, erase unnecessary tracks or use another recordable MD.

"Disc Full" lights up before the maximum number of tracks is reached

Fluctuations in emphasis within tracks are sometimes interpreted as track intervals, increasing the track count and causing "Disc Full" to light up.

The remaining recording time does not increase even after erasing numerous short tracks

Tracks under 12 seconds in length are not counted and so erasing them may not lead to an increase in the recording time.

Some tracks cannot be combined with others

Track combination may become impossible when tracks are edited.

The total recorded time and the remaining time on the MD may not total the maximum recording time (60 or 74 minutes)

Recording is done in minimum units of 2 seconds each, no matter how short the material. The contents recorded may thus be shorter than the maximum recording capacity. Disc space may also be further reduced by scratches.

Tracks created through editing may exhibit sound dropout during search operations.

Track numbers are not recorded correctly

Incorrect assignment or recording of track numbers may result when CD tracks are divided into several smaller tracks during digital recording.

"TOC Reading" appears for a long time

If the inserted recordable MD is brand new, "TOC Reading" appears in the display longer than for MDs that have been used.

Limitations when recording over an existing track

- The correct remaining recording time may not be displayed.
- You may find it impossible to record over a track if that track has been recorded over several times already. If this happens, erase the track using the Erase Function.
- The remaining recording time may be shortened out of proportion to the total recorded time.
- Recording over a track to eliminate noise is not recommended since this may shorten the duration of the track.
- You may find it impossible to label a track while recording over it.

The correct recorded/playing time may not be displayed during playback of monaural-format MDs.

MD Display Messages

The following table explains the various messages that appear in the display.

Message	Meaning
All Erase?	Erase all tracks on an MD? (Erase Function)
Attenuate?	Attenuate the recording level during analog recording?
Auto cut	The MD deck is pausing the recording because silence continued for 30 seconds or more during digital recording.
Blank Disc	The inserted recordable MD is brand new or all tracks on the MD have been erased.
Cannot Copy	You cannot make a digital recording. (See "Guide to the Serial Copy Management System".)
Cannot EDIT	You tried to edit in PROGRAM or SHUFFLE play mode.
Combine?	Combine two tracks into one? (Combine Function)
Disc Error	The inserted MD is damaged, or does not contain a TOC.
Disc Full	You can not make recording because there is no time remaining on the disc. (See "System Limitations of MD".)

Divide?	Divide one recorded track into two tracks? (Divide Function)
Eject	Displayed when you remove the MD.
Erase?	Erase a single track on an MD? (Erase Function)
Impossible	You tried to combine from the first track on an MD, which is not possible.
LEVEL SYNC?	Mark track numbers automatically during recording? (Level Synchro Function)
Move?	Change the order of the tracks by moving tracks to any desired position? (Move Function)
Name Full	There is no more space to store track or disc titles.
Name in?	Create titles for your recorded MDs and tracks? (Title Function)
NO DISC	There is no MD in the deck.
No Track	The inserted MD has a disc title but no tracks.
OVER	The end of the last track was reached while conducting a high-speed search.
Protected	The inserted MD is protected against erasure.
REC LEVEL OVER	A high-level signal was input while recording from audio equipment connected to this unit's TAPE IN jacks.
Retry	The MD deck is redoing the recording because of vibrations or disc scratches encountered during recording.
Retry Error	Because of numerous vibrations or disc scratches, continuous recording attempts have been made but normal recording is not possible.
Smart Space	The signal was input again after silence continued for 30 seconds or less during digital recording.
Sorry	You tried to combine tracks that cannot be combined

TOC (flashing)	The MD deck is updating the table of contents (TOC). (Do not move the MD deck or pull out the AC power cord. If you do, the recorded material may not be saved normally. If you disconnect the AC power cord immediately after recording, you cannot save the recording.)
TOC Reading	The MD deck is reading the contents of the MD. (If the inserted recordable MD is brand new, "TOC Reading" appears in the display longer than for MDs that have been used.)
TRACK (lighted)	The MD deck is recording a blank portion.
TRACK (flashing)	The MD deck is recording over existing material.
Welcome	Displayed when you insert an MD.

Troubleshooting Guide

If you run into any problem using the stereo, use the following check list after first checking the following two points:

- The AC power cord is connected firmly.
- The speakers are connected correctly and firmly.

Should any problem persist after you have made the checks below, consult your nearest Sony dealer.

General

There is no sound.

- m Press POWER to turn on the stereo.
- m Adjust the volume.
- m The headphones are connected. Disconnect them.

The left and right sounds are reversed.

- m Check the speaker connection and speaker placement.

There is severe hum or noise.

- m TV or VCR is too close to the stereo system. Move the stereo system away from the TV or VCR.

"12:00 AM" flashes in the display.

- m AC power interruption occurred. Set the clock and timer settings again.

CD Player

The CD tray does not close.

- m The CD is not placed correctly.

The CD will not play.

- m The CD is dirty.
- m The CD is inserted with the label side down.
- m The player is in pause mode.
- m Moisture condensation has built up. Leave the system turned on for about an hour until the moisture evaporates.

Play does not start from the first track.

- m The CD player is in program or shuffle mode. Press CONTINUE. The "PROGRAM" or "SHUFFLE" display will disappear.

"OVER" appears in the display.

- m The CD reaches the end while you are searching quickly by pressing) down.

"Step Full" appears in the display.

- m You have programmed 24 tracks already.

"Name Full" appears in the display.

- m You have put 21 disc names already.

MD Deck

The MD deck does not operate or operates poorly.

- m The MD may be damaged ("Disc Error" appears). Take the MD out and insert it again. If "Disc Error" remains, replace the MD.

The MD deck does not play back.

- m Moisture condensation has built up. Take the MD out and leave the system turned on for about an hour until the moisture evaporates.
- m The MD is inserted in the wrong direction. Slide the MD into the disc compartment with the label side up and the arrow pointing towards the opening until the deck grips it.
- m The MD may not be recorded. Replace the disc with one that has been recorded.

The MD deck does not record.

- m The MD is record-protected ("Protected" appears). Slide the tab to close the slot.
- m A premastered MD is inserted. Replace it with a recordable MD.

- m There is not enough time left on the MD. Replace it with another recordable MD with fewer recorded tracks or erase unnecessary tracks.

An incompletely inserted MD cannot be pulled out.

- m The MD deck's self-lock system has gripped the MD. Insert the MD completely, then press MD §.

"OVER" appears in the display.

- m The MD reaches the end while you are searching quickly by pressing) down.

The sound has a lot of static.

- m Strong magnetism from a television or a similar device is interfering with operations. Move the deck away from the source of strong magnetism.

Tuner

"TUNED" flashes in the display.

- m Adjust the antenna.

"STEREO" flashes in the display.

- m Adjust the antenna.

Severe hum or noise.

- m Adjust the antenna.
- m The signal strength is too weak. Connect the external antenna.
- m Connect the earth wire.

A stereo FM program cannot be received in stereo.

- m When "MONO" appears in the display, press STEREO/MONO on the remote so that "MONO" disappears.
- m Adjust the antenna.

Timer

The timer does not function.

- m Set the clock correctly.
- m The AC power has been cut off. While the timer works, press the POWER switch to turn off the system.
- m Make sure "DAILY" or "REC" appears in the display.

Remote

The remote does not function.

- m The battery have run down. Replace the battery.
- m There is an obstacle between the remote and the system. Remove the obstacle.

Restoring the Factory Settings

- 1 Unplug the AC power cord.
- 2 Plug it back into wall outlet while holding down POWER on the unit.

Specifications

For the U.S. model AUDIO POWER SPECIFICATIONS POWER OUTPUT AND TOTAL HARMONIC DISTORTION:

With 6 ohm loads, both channels driven, from 40 – 16,000 Hz; rated 30 watts per channel minimum RMS power, with no more than 1.0% total harmonic distortion from 250 milliwatts to rated output.

CD player section

System	Compact disc and digital audio system
Laser	Semiconductor laser ($\lambda=780$ nm) Emission duration: continuous
Laser output	Max 44.6 μ W* * This output is the value measured at a distance of 200 mm from the objective lens surface on the Optical Pick-up Block with 7 mm aperture.
Wavelength	780 – 790 nm
Frequency response	2 Hz – 20 kHz

MiniDisc deck section

System	MiniDisc digital audio system
Disc	MiniDisc
Laser	Semiconductor laser ($\lambda = 780$ nm)
Laser output	Max 44.6 μ W* * This output is the value measured at a distance of 200 mm from the objective lens surface on the Optical Pick-up Block with 7 mm aperture.
Laser diode properties	Material: GaAlAs
Revolutions (CLV)	Approx. 400 rpm to 900 rpm
Error correction	Advanced Cross Interleave Reed Solomon Code (ACIRC)

Sampling frequency	44.1 kHz
Modulation system	EFM (Eight-to-Fourteen Modulation)
Number of channels	2 stereo channels
Frequency response	5 Hz – 20 kHz
Wow and flutter	Below measurable limit

Tuner section

FM tuner section

Tuning range	U.S. and Canadian models: 87.5 – 108.0 MHz (100 kHz step) Other models: 87.5 – 108.0 MHz (50 kHz step)
Antenna	FM lead antenna
Antenna terminals	75 ohm unbalanced
Intermediate frequency	10.7 MHz

AM tuner section

Tuning range	U.S. and Canadian models: 530 – 1,710 kHz (with the tuning interval set at 10 kHz) Other models: 531 – 1,602 kHz (with the tuning interval set at 9 kHz)
Antenna	AM loop antenna, External antenna terminals
Intermediate frequency	450 kHz

Timer section

System	Quartz lock system
Timer setting	One-minute step
Sleep timer	10-minute step, max. 90 minutes

Amplifier section

Continuous RMS power output	U.S. model: 30 W + 30 W (6 ohms at 40 Hz – 16 kHz, 1.0% THD) 35 W + 35 W (6 ohms at 1 kHz, 5% THD) Other models: 35 W + 35 W (6 ohms at 1kHz, 5% THD)
Peak music power output	350 W
Inputs	TAPE (phono jacks): voltage 250 mV impedance 47 kilohms
Outputs	TAPE (phono jacks): voltage 250 mV impedance 1 kilohms PHONES (stereo phone jack): accepts headphones of 8 ohms or more.

Speaker section (SS-MJ1)

Speaker system	2-way, bass reflex type
Speaker units	Woofer: 13 cm (5 1/8 in.), cone type Tweeter: 2.5 cm (1 in.), dome type
Rated impedance	6 ohms
Dimensions	Approx. 190 x 385 x 165 mm (7 1/2 x 15 1/4 x 6 1/2 in.) (w/h/d) incl. projecting parts and controls
Mass	Approx. 4.0 kg (8 lb 13 oz)

Supplied accessories

Sony RM-SMJ1 Remote (1)
Sony lithium battery, CR2025 (1)
FM lead antenna (1)
AM loop antenna (1)
Speaker cords (2)

General

Power requirements	U.S. and Canadian model: 120 V AC, 60 Hz Other models: 110 – 120 V or 220 – 240 V AC, 50/60 Hz Adjustable with the voltage selector
Power consumption	95 W
Dimensions	Approx. 430 x 95 x 290 mm (17 x 3 3/4 x 11 1/2 inches) (w/h/d) incl. projecting parts and controls
Mass	Approx. 7.0 kg (15 lb 7 oz)

Design and specifications are subject to change without notice.

Index to Parts and Controls

Refer to the pages indicated in parentheses for how to use the controls. Controls with an asterisk have built-in lamps on themselves.

Front Panel

CD player section

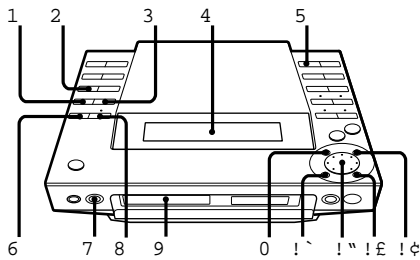

- 1 PLAY MODE button (9)
- 2 CHARACTER button (10)
- 3 REPEAT button (8)
- 4 Display window (7, 8)
- 5 DISPLAY button (8)
- 6 EDIT/NO button (10)
- 7 CD § (eject) button (7)
- 8 ENTER/YES button (9, 10)
- 9 Disc tray (7)
- 0 fl (play/pause) button (7)
- ! j 0 (fast backward) button (8)
- !™ JOG dial (7)
- !£) (fast forward) button (8)
- !¢ (stop) button (7)

MiniDisc deck section

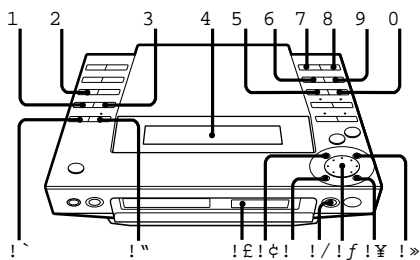

- 1 PLAY MODE button (13)
- 2 CHARACTER button (21)
- 3 REPEAT button (12)
- 4 Display window (11, 12)
- 5 REC PAUSE button (15)
- 6 CD SYNCHRO button (15)
- 7 DISPLAY button (12)
- 8 SCROLL button (12, 21)
- 9 REC button (16)
- 0 REC STOP button (15)
- ! j EDIT/NO button (15, 18)

- !™ ENTER/YES button (13, 15, 18)
- ! £ Disc slot (11)
- ! ¢ fl (play/pause) button (11)
- ! 0 (fast backward) button (12)
- ! § MD § (eject) button (11)
- ! ¶ JOG dial (11)
- ! •) (fast forward) button (12)
- ! ª (stop) button (11)

Tuner section

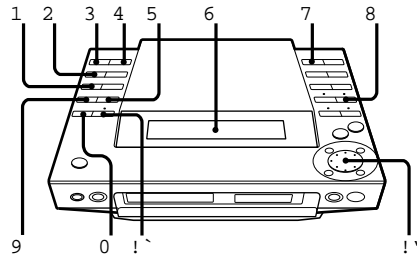

- 1 CHARACTER button (23)
- 2 CLOCK button (6)
- 3 TIMER SELECT button (27)
- 4 TIMER SET button (26)
- 5 STEREO/MONO button (22)
- 6 Display window (22)
- 7 DISPLAY button (24)
- 8 TUNER/BAND button (22)
- 9 TUNING button (22)
- 0 EDIT/NO button (23)
- ! j ENTER/YES button (23)
- !™ JOG dial (22)

Amplifier section

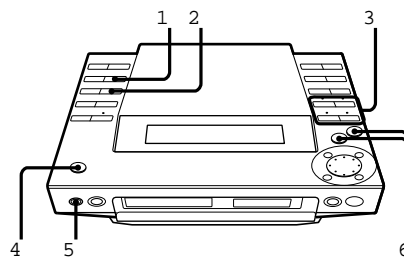

- 1 BASS/TREBLE button (25)
- 2 BALANCE button (25)
- 3 FUNCTION buttons
TAPE button (16, 28)
MD button (11, 18)
CD button (7, 16)
TUNER/BAND button (16, 22)
- 4 POWER switch (7, 27)
- 5 PHONES jack (25)
- 6 VOLUME +/- buttons (25)

Rear Panel

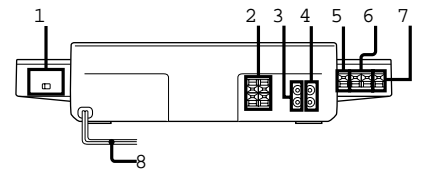

- 1 VOLTAGE SELECTOR (except for the U.S. and Canadian model) (5)
- 2 SPEAKER connectors (4)
- 3 TAPE OUT jacks (28)
- 4 TAPE IN jacks (28)
- 5 FM 75 Ω connector (4)
- 6 y (earth) terminal (4)
- 7 AM terminal (4)
- 8 AC power cord (5)

Display Window

CD player section

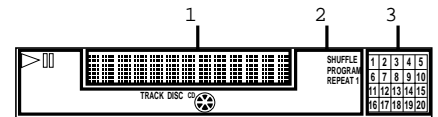

- 1 Playing time/track number indication (7)
- 2 CD indication
fl (play/pause) (7)
REPEAT 1 (8)
SHUFFLE (9)
PROGRAM (9)
DISC (7)
TRACK (7)
- 3 Music calendar (7)

MD deck section

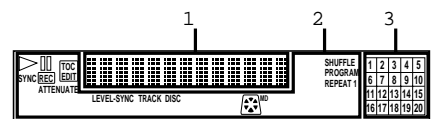

- 1 Playing time/track number/title indication (11)
- 2 MD indication
fl (play/pause) (11)
[REC] (15)
SYNC (synchro) (15)
LEVEL-SYNC (level synchro) (14)
` (TOC edit) (15)
REPEAT 1 (12)
SHUFFLE (13)
PROGRAM (13)
DISC (11)
TRACK (11)
- 3 Music calendar (11)

Tuner section

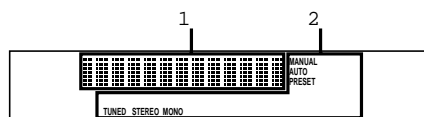

- 1 Frequency/time/station name indications (6, 22, 23, 26)
- 2 Tuner indications
TUNED (22)
STEREO MONO (22)
MANUAL (22)
AUTO (22)
PRESET (24)

Remote (RM-SMJ1)

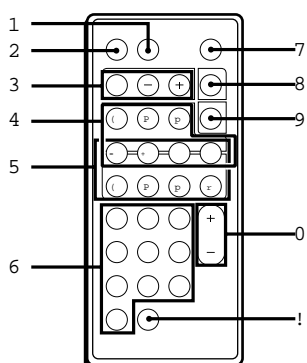

- 1 SLEEP button (26)
- 2 FUNCTION button (16)
- 3 Tuner operating buttons
BAND button (22)
PRESET + / - buttons (24)
- 4 CD operating buttons
((play) button (7)
P (pause) button (7)
p (stop) button (7)
=(search backward) button (7)
+ (search forward) button (7)
REPEAT button (8)
P.MODE (play mode) button (9)
- 5 MD operating buttons
((play) button (11)
P (pause) button (11)
p (stop) button (11)
=(search backward) button (11)
+ (search forward) button (11)
r REC button (16)
REPEAT button (12)
P.MODE (play mode) button (13)
- 6 Numeric buttons (7, 11, 24)
- 7 POWER button (7)
- 8 DISPLAY button (8, 12)
- 9 SCROLL button (12, 21)
- 0 VOL +/- buttons (25)
- ! ; >10 button (7, 11, 24)

Index

- Antennas 4, 32
- Assigning
a name to a CD 10
- CD
inserting 7
taking out 7
- CD synchro-recording 15
- Checking
the display (CD) 8
the display (MD) 12
- Clock setting 6
- Combining 20
- Connecting
the system 4
optional equipment 28
- Display
checking the display (CD) 8
checking the display (MD) 12
MD display messages 31
- Dividing 19
- Erasing
all tracks 18
a part of a track 19
a single track 18
a station name 24
- Inserting battery 6
- Labeling
a CD 10
an MD 20
radio stations 23
- Listening
the radio 22
- Locating
a particular point in a track (CD) 8
a particular point in a track (MD) 12
a specific track (CD) 7
a specific track (MD) 11
- MD
inserting 11
premastered 12
recordable 12, 15
system limitations 31
taking out 11
- Moving tracks 19
- Music calendar
CD 7
MD 11
- Playing
a CD (normal play) 7
an MD (normal play) 11
tracks in random order (shuffle play)
(CD) 9
tracks in random order (shuffle play)
(MD) 13
track in the desired order (program
play) (CD) 9
track in the desired order (program
play) (MD) 13
tracks repeatedly (repeat play) (CD) 8
tracks repeatedly (repeat play) (MD) 12
- Radio stations
assigning a name 23
presetting 23
tuning in 22

- Recording
a CD 15
analog 14
before recording 14
digital 14
a radio program 15
- Recording CDs on an MD
automatically 15
manually 16
- Record-protect tab 15
- Remote 7, 11, 26, 34
- SCMS (Serial Copy Management
System) 14, 30
- Sound adjusting 25
- Station name 23
- Timer
falling asleep to music 26
timer recording 27
waking up to music 26
- TOC (Table Of Contents) 15
- Track marking
automatic track marking 17
manual track marking 16
- Tuner 22
- Voltage selector 5

