

FM/AM Portable CD Player

Operating Instructions

About the area code

The area code of the location in which you purchased the CD player is shown on upper left of the bar code label on the package.

For accessories supplied with your CD player, check the area code of your model and see "Accessories (supplied/optional)."



"WALKMAN" is a trademark of Sony Corporation.

D-F21

WARNING

To prevent fire or shock hazard, do not expose the unit to rain or moisture.

Do not install the appliance in a confined space, such as a bookcase or built-in cabinet.

To prevent fire, do not cover the ventilation of the apparatus with newspapers, tablecloths, curtains, etc. And don't place lighted candles on the apparatus.

To prevent fire or shock hazard, do not place objects filled with liquids, such as vases, on the apparatus.

Treat batteries as toxic waste. Do not dispose with regular garbage.

CAUTION

The use of optical instruments with this product will increase eye hazard.

Certain countries may regulate disposal of the battery used to power this product. Please consult with your local authority.

Table of Contents

Getting started

Locating the controls 4

Playing a CD

1. Connect your CD player. 6

2. Insert a CD. 6

3. Play a CD. 6

Playback options 8

Using the radio

Listening to the radio 9

Presetting radio stations 11

Playing preset radio stations 12

Changing the tuning interval 12

Available features

To maximize the skip protection performance
(ESP MAX) 13

Emphasizing the bass sound (SOUND) 13

Protecting your hearing (AVLS) 14

Locking the controls (HOLD) 14

Turning off the operation beep sound 15

Connecting your CD player

Connecting a stereo system 16

Connecting to a power source

Using the dry batteries 17

Notes on the power source 18

Additional information

Precautions 19

Maintenance 19

Troubleshooting 20

Specifications 22

Accessories (supplied/optional) 23

Getting started

Locating the controls

For details, see pages in parentheses.

CD player (front)

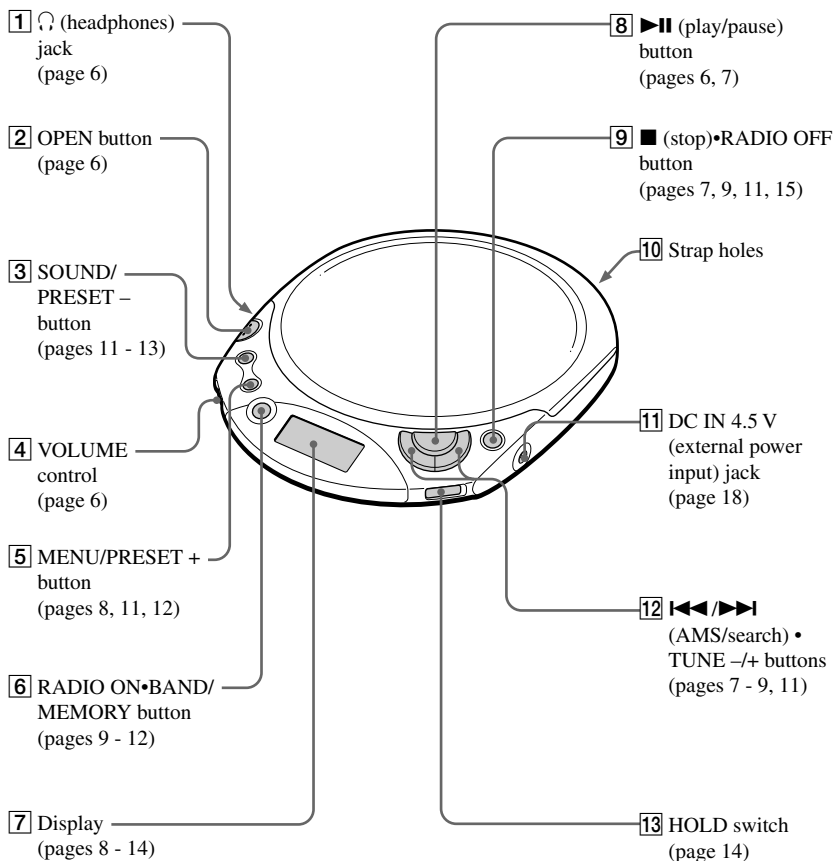

CD player (inside)

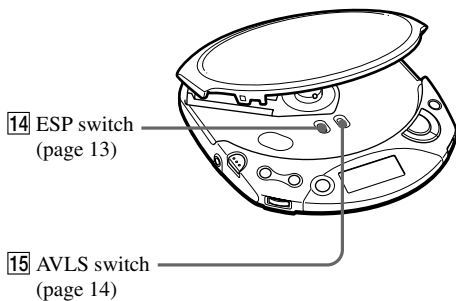

CD player (rear)

- 16 E13/2 model:
MONO/ST (stereo) switch (page 10)
Other models:
LOCAL/DX switch (page 10)

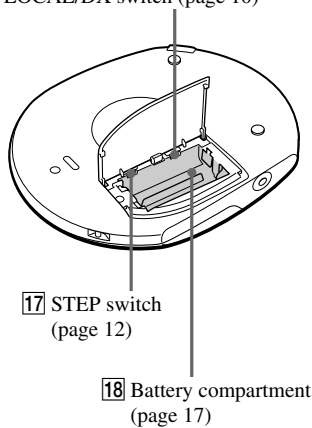

Playing a CD

You can also use dry batteries as a power source.

1. Connect your CD player.

- 1 Connect the AC power adaptor.
- 2 Connect the headphones/earphones.

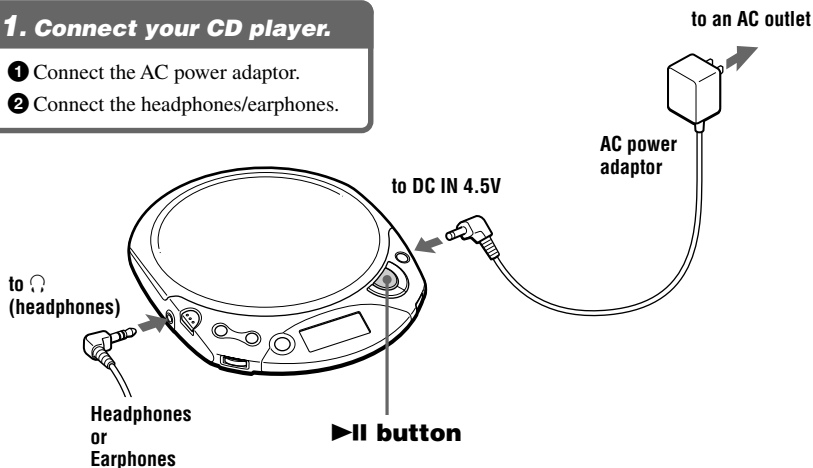

2. Insert a CD.

- 1 Press OPEN to open the lid.

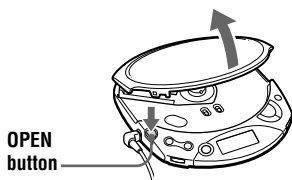

- 2 Place the CD on the tray and close the lid.

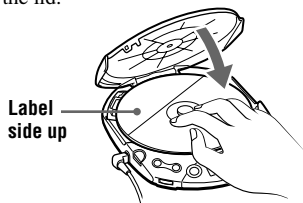

3. Play a CD.



To	Press
Play/Pause	▶
Stop	■*2
Find the beginning of the current track (AMS*1)	◀◀ once quickly*2
Find the beginning of the previous tracks (AMS)	◀◀ repeatedly*2
Find the beginning of the next track (AMS)	▶▶ once quickly*2
Find the beginning of the succeeding tracks (AMS)	▶▶ repeatedly*2
Go backwards quickly	Hold down ◀◀*2
Go forward quickly	Hold down ▶▶*2

*1 Automatic Music Sensor

*2 These operations can be done during both play and pause.

About the display

- When you press ▶|| after changing the CD or turning off and on the player, the total number of tracks in the CD and total playing time appear for about two seconds.
- During play, the track number and the elapsed playing time of the current track appear.
- During pause, the elapsed playing time flashes.

If the volume level does not increase

If AVLS is set to "LIMIT", set it to "NORM." For details, see "Protecting your hearing (AVLS)."

About CD-Rs

This CD player is compatible with CD-Rs but playback capability may vary depending on the quality of the disc, the recording device and application software.

Removing the CD

Remove the CD while pressing the pivot in the center of the tray.

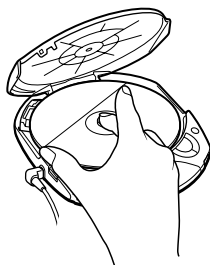

Playback options

You can enjoy various ways of playback using MENU.

MENU button

Each time you press the button, you can change the playback mode.

No indication
(Normal play)



“↺”
(Play all tracks repeatedly)*



“1”
(Play a single track)



“↺ 1”
(Play a single track repeatedly)



“↺ SHUF”
(Play tracks in random order repeatedly)

Display

Play mode indication



* During Repeat play, you can locate the first track after the last track by pressing ►► repeatedly. You can also locate the last track after the first track by pressing ◀◀ repeatedly.

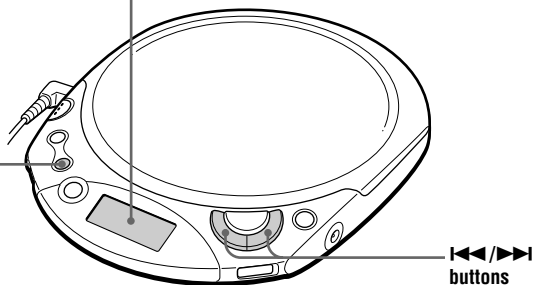

Using the radio

Once you've preset the stations, you can easily tune in the station by pressing PRESET + or - button.

Listening to the radio

You can enjoy FM and AM programs.

1 Press RADIO ON•BAND to turn on the radio.

2 Press RADIO ON•BAND until the band you want appears.

Each time you press the button, the display changes as follows:

→ FM1 → FM2 → FM3 → FM4 → FM5 → AM →

3 Press TUNE + or - to tune in the station you want and adjust the volume.



To turn off the radio

Press ■•RADIO OFF.

To tune in the station quickly

Hold down TUNE + or - in step 3 until the frequency digits begin to change in the display. The CD player automatically scans the radio frequencies and stops when it finds a clear station.

(Continued)

Listening to the radio

To improve broadcast reception

For FM, extend the headphones/earphones cord.

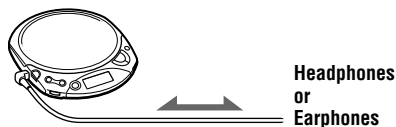

For AM, reorient the CD player itself.

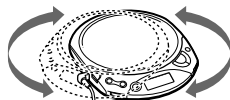

Note

Keep the headphones/earphones connected to the ϕ jack of the CD player. The headphones/earphones cord works as the FM antenna.

If it is hard to hear the FM broadcast

For the models equipped with the LOCAL/DX switch:

Set the LOCAL/DX switch to "LOCAL" using a pointed material.

Under the normal conditions, set it to "DX."

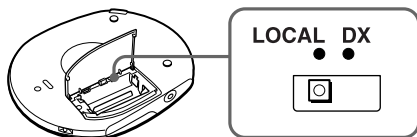

For the models equipped with the MONO/ST switch:

Set the MONO/ST switch to "MONO" using a pointed material.

The noise will be reduced but the radio will play in monaural.

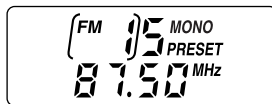
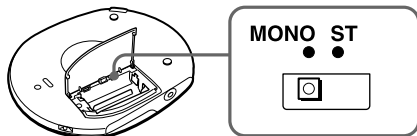

When listening to the radio on batteries

If you connect the external power source plug to the DC IN 4.5 V jack of your CD player, the CD player will turn off. Turn it on by pressing RADIO ON•BAND to continue listening to it.

Presetting radio stations

You can store radio stations into the CD player's memory. You can preset up to 30 stations, 5 for each band (FMI - 5 and AM) in any order.

- 1** Press **RADIO ON•BAND** to turn on the radio.
 - 2** Press **RADIO ON•BAND** to select the band.
 - 3** Hold down **MEMORY** until **"PRESET"** flashes in the display.
From this step on, start the next operation within 10 seconds after you finished the previous operation. If 10 seconds pass with nothing done, "PRESET" stops flashing which shows that the CD player has exited the PRESET MEMORY standby mode. If this happens, start from step 3 again.
 - 4** Press **PRESET +** or **-** repeatedly to select the preset number you want to store the station on while **"PRESET"** flashes.
 - 5** Press **TUNE +** or **-** to tune in the station you want while **"PRESET"** flashes.
 - 6** Press **MEMORY**.
When the station is preset successfully, the beep sounds and "PRESET" stops flashing in the display. The new station replaces the old one.
- FM:



AM:

- After 2 seconds, "PRESET" starts flashing again and the CD player enters the PRESET MEMORY standby mode.
- 7** Repeat steps 4 to 6 when you preset the stations in the same band. When you preset the stations in the different band, repeat steps 2 to 6 after "PRESET" stops flashing.

To exit the PRESET MEMORY standby mode

When the radio is turned on, you can exit the PRESET MEMORY standby mode using one of the following procedures. Preset stations, however, will remain stored in the CD player's memory.

- Hold down **MEMORY** until "PRESET" stops flashing.
- Do not press any button for 10 seconds. "PRESET" stops flashing.
- Press **▶II**. The CD player enters the CD playing mode.
- Press **■•RADIO OFF**. The radio turns off.

(Continued)

Presetting radio stations

To cancel all preset stations

- 1 Disconnect the power source (alkaline batteries or AC power adaptor).
- 2 While you press and hold down MEMORY, insert alkaline batteries or connect the AC power adaptor again.

The indications in the display keep flashing until all preset stations are cleared, then stop flashing and disappear from the display.



Playing preset radio stations

You can tune in the station easily by pressing PRESET + or – button.

- 1 Press RADIO ON•BAND to select the band.
- 2 Press PRESET + or – to tune in a stored station.

Changing the tuning interval

When using the CD player abroad, change the AM tuning interval, if necessary. Set the STEP switch (in the battery compartment) to “9 kHz” or “10 kHz” using a pointed material.

9 kHz area: Asia and Europe

10 kHz area: the U.S.A., Canada and South America

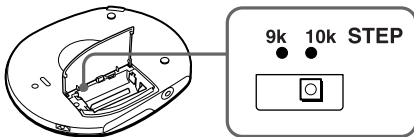

Notes

- The interval will not change until you once turn off the radio and then turn it on again.
- After changing the tuning interval, you need to preset radio stations again.

► Available features

To maximize the skip protection performance (ESP MAX)

The typical ESP (Electronic Shock Protection) function minimizes skipping by using a buffer memory that stores music data and plays it back in the event of a shock.

The ESP MAX system is an extremely sophisticated technology. Due to the light weight and improved anti-shock characteristics of the optical block, this system recovers from the skipping much quicker than conventional technology such as ESP or ESP².*

* Although ESP MAX provides excellent protection, skipping may occasionally occur.

Set ESP (under the lid) to "ON."



Displayed when the ESP MAX function is activated.

To turn off the ESP MAX function

Set ESP to "OFF."

Notes

- Playing may stop when the CD player gets a strong shock even with the ESP MAX function on.
- You may hear a noise or sound may skip:
 - when listening to a dirty or scratched CD,
 - when listening to an audio test CD,
 - when the player receives continuous shock or
 - when using poor-quality CD-Rs or if there is a problem with the recording device or application software.

Emphasizing the bass sound (SOUND)

You can emphasize the bass-boosted sound.

Press **SOUND** to select "BASS ■" or "BASS ■■."

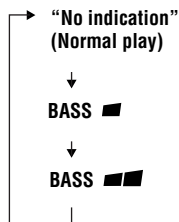

The selected sound mode is displayed.

"BASS ■■" enhances the bass sound more than "BASS ■."

Notes

- If the sound is distorted when using the SOUND function, turn down the volume.
- When listening to the radio, the SOUND function does not work.

Protecting your hearing

(AVLS)

The AVLS (Automatic Volume Limiter System) function keeps down the maximum volume to protect your hearing.

Set AVLS (under the lid) to "LIMIT."



Displayed when "LIMIT" is selected and AVLS function is activated.

To turn off the AVLS function

Set AVLS to "NORM."

Locking the controls

(HOLD)

You can lock the controls on your CD player to prevent accidental button presses.

Slide HOLD in the direction of the arrow.

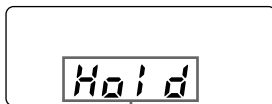
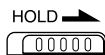

Displayed when the HOLD function is activated.

To unlock the controls

Slide HOLD in the opposite direction of the arrow.

Turning off the operation beep sound

You can turn off the beep sound that is heard from your headphones when you operate your CD player.

1 Remove the power source (AC power adaptor or dry batteries) from the CD player.

2 Connect the power source while pressing ■ on the CD player.

To turn on the beep sound

Remove the power source and then connect the power source without pressing ■

► Connecting your CD player

Connecting a stereo system

You can listen to CDs through a stereo system and record CDs on a cassette tape. For details, see the instruction manual that comes with the connected device.

Be sure to turn off all connected devices before making connections.

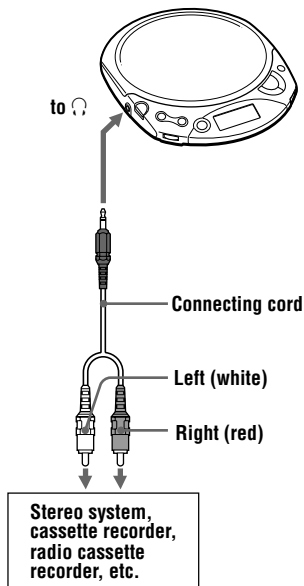

Notes

- Before you play a CD, turn down the volume of the connected device to avoid damaging the connected speakers.
- Use the AC power adaptor for recording. If you use the dry batteries as a power source, they may become completely depleted during recording.
- Adjust the volume properly on the connected device so that the sound will not be distorted.

► Connecting to a power source

You can use the following power sources:

- AC power adaptor (see “Playing a CD”)
- LR6 (size AA) alkaline batteries

For the battery life, see “Specifications.”

Using the dry batteries

Use only the following dry battery type for your CD player:

- LR6 (size AA) alkaline batteries

Note

Be sure to remove the AC power adaptor when using the dry batteries.

1 Open the battery compartment lid.

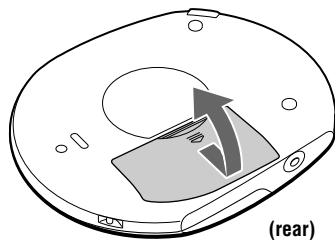

2 Insert two LR6 (size AA) batteries by matching the ⊕ to the diagram in the battery compartment.

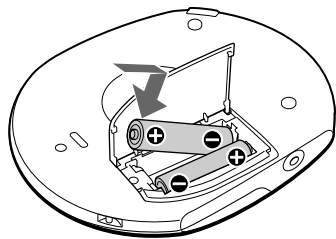

To remove the batteries

Remove the batteries as illustrated below.

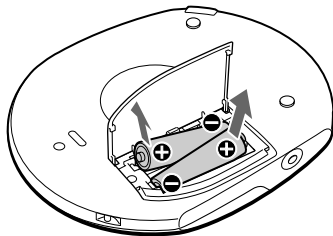

When to replace the batteries

You can check the remaining power of the batteries in the display.

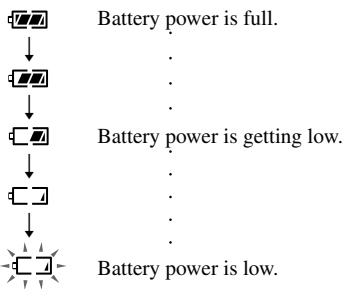

Lo batt* Batteries are depleted.



* Beep sounds.

When the batteries are depleted, replace both batteries with new ones.

(Continued)

Using the dry batteries

Notes

- The indicator sections of  roughly shows the remaining battery power. One section does not always indicate one-fourth of the battery power.
- Depending on operating conditions, the indicator sections of  may increase or decrease.

To attach the battery compartment lid

If the battery compartment lid is detached by an accidental drop, excessive force, etc., attach it as illustrated below.

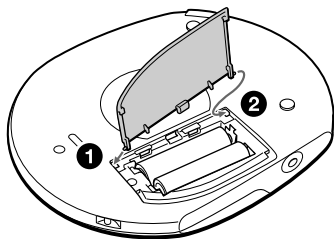

Notes on the power source

Disconnect all power sources when the CD player is not used.

On AC power adaptor

- Use only the AC power adaptor supplied or recommended in “Accessories (supplied/optional).” Do not use any other AC power adaptor. It may cause a malfunction.

Polarity of the plug



- When disconnecting the AC power adaptor from the AC outlet, grasp the adaptor itself. Do not pull it by the cord.
- Do not touch the AC power adaptor with wet hands.

On dry batteries

- Do not charge the dry batteries.
- Do not throw the batteries into fire.
- Do not carry the batteries with coins or other metallic objects. It can generate heat if the positive and negative terminals of the battery are accidentally contacted by a metallic object.
- Do not mix rechargeable batteries with dry batteries.
- Do not mix new batteries with old ones.
- Do not use different types of batteries together.
- When the batteries are not to be used for a long time, remove them.
- If battery leakage occurs, wipe off any deposit in the battery compartment, and install new batteries. In case the deposit adheres to you, wash it off thoroughly.

Precautions

On safety

- Should any solid objects or liquid fall into the CD player, unplug it and have it checked by qualified personnel before operating it any further.
- Do not put any foreign objects in the DC IN 4.5 V (external power input) jack.

On the CD player

- Keep the lens on the CD player clean and do not touch it. If you do so, the lens may be damaged and the CD player will not operate properly.
- Do not put any heavy object on top of the CD player. The CD player and the CD may be damaged.
- Do not leave the CD player in a location near heat sources, or in a place subject to direct sunlight, excessive dust or sand, moisture, rain, mechanical shock, unlevelled surface, or in a car with its windows closed.
- If the CD player causes interference to the radio or television reception, turn off the CD player or move it away from the radio or television.
- Discs with non-standard shapes (e.g., heart, square, star) cannot be played on this CD player. Attempting to do so may damage the CD player. Do not use such discs.

On handling CDs

- To keep the CD clean, handle it by its edge. Do not touch the surface.
- Do not stick paper or tape onto the CD.

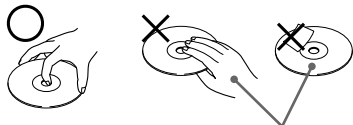

Not these ways

- Do not expose the CD to direct sunlight or heat sources such as hot air ducts. Do not leave the CD in a car parked under direct sunlight.

On headphones/earphones

Road safety

Do not use headphones/earphones while driving, cycling, or operating any motorized vehicle. It may create a traffic hazard and is illegal in some areas. It can also be potentially dangerous to play your headsets at high volume while walking, especially at pedestrian crossings. You should exercise extreme caution or discontinue use in potentially hazardous situations.

Preventing hearing damage

Avoid using headphones/earphones at high volume. Hearing experts advise against continuous, loud and extended play. If you experience a ringing in your ears, reduce volume or discontinue use.

Consideration for others

Keep the volume at a moderate level. This will allow you to hear outside sounds and to be considerate to the people around you.

Maintenance

To clean the casing

Use a soft cloth slightly moistened in water or a mild detergent solution. Do not use alcohol, benzene or thinner.

Troubleshooting

Should any problem persist after you have checked these symptoms, consult your nearest Sony dealer.

CD player

Symptom	Cause and/or corrective actions
The volume does not increase even if the VOLUME control is adjusted to the maximum level.	→ Set the AVLS switch to "NORM." (page 14)
No sound, or noise is heard.	→ Connect the plugs firmly. (page 6) → Plugs are dirty. Clean the plugs with a dry soft cloth periodically.
The playing time is too short when powered with the dry batteries.	→ Check that you are using alkaline batteries and not manganese batteries. (page 17) → Replace the batteries with new LR6 (size AA) alkaline batteries. (page 17)
When you press ►II, "Lo batt" or "00" appears in the display. The CD does not play.	→ Replace the batteries with new LR6 (size AA) alkaline batteries. (page 17)
"Hi dc In" appears in the display.	→ Use only the AC power adaptor or car battery cord in "Accessories (supplied/optional)." (page 23) → Remove all power sources, then insert the batteries or connect the AC power adaptor again. (pages 6, 17)
The CD does not play or "no dISC" appears in the display when a CD is placed in the CD player.	→ The buttons are locked. Slide the HOLD switch back. (page 14) → The CD is dirty or defective. (page 19) → Check that the CD is inserted with the label side up. (page 6) → Moisture condensation has occurred. Leave the CD player aside for several hours until the moisture evaporates. → Close the lid of the battery compartment firmly. (page 17) → Make sure the batteries are inserted correctly. (page 17) → Connect the AC power adaptor to an AC outlet securely. (page 6) → The CD-R was not finalized. Finalize the CD-R with the recording device. → There is a problem with the quality of the CD-R, recording device, or application software.
"Hold" appears in the display when you press a button, and the CD does not play.	→ The buttons are locked. Slide the HOLD switch back. (page 14)
The rechargeable batteries cannot be charged in the battery compartment of this player.	→ This CD player does not have the function to charge the rechargeable batteries.
Playback starts from the point you stopped. (resume function)	→ The resume function is working. To start from the first track, open the lid of the CD player; or remove all power sources, then insert the batteries or connect the AC power adaptor again. (pages 6, 17)

Radio

Symptom	Cause and/or corrective actions
The audio is weak or has poor quality.	<ul style="list-style-type: none">→ Replace the batteries with new LR6 (size AA) alkaline batteries. (page 17)→ Move the CD player away from the TV.

Specifications

CD player

System

Compact disc digital audio system

Laser diode properties

Material: GaAlAs

Wavelength: $\lambda = 780$ nm

Emission duration: Continuous

Laser output: Less than 44.6 μ W

(This output is the value measured at a distance of 200 mm from the objective lens surface on the optical pick-up block with 7 mm aperture.)

D-A conversion

1-bit quartz time-axis control

Frequency response

20 - 20 000 Hz ± 1 dB (measured by JEITA CP-307)

Output (at 4.5 V input level)

Headphones (stereo minijack)

Approx. 12 mW + Approx. 12 mW at 16 Ω

Radio

Frequency range (STEP switch)

9 kHz step:

FM: 87.5 - 108.0 MHz

AM: 531 - 1 710 kHz

10 kHz step:

FM: 87.5 - 108.0 MHz

AM: 530 - 1 710 kHz

Antenna

FM: Headphones/earphones cord antenna

AM: Built-in ferrite bar antenna

General

Power requirements

For the area code of the model you purchased, check the upper left side of the bar code on the package.

- Two LR6 (size AA) batteries: 3 V DC
- AC power adaptor (DC IN 4.5 V jack):
U/U2/CA2/E92/MX2/TW2/BR3 model:
120 V, 60 Hz
CED/CET/CEW/CEX/CE7/EE/EE1/E13/G5/
G6/G7/G8/BR1 model:
220 - 230 V, 50/60 Hz
CEK/3CE7 model: 230 - 240 V, 50 Hz
AU2 model: 240 V, 50 Hz
JE.W/E33/EA3/KR4 model: 100 - 240 V,
50/60 Hz
HK2 model: 220 V, 50/60 Hz
AR1/CN2 model: 220 V, 50 Hz

Battery life* (approx. hours)

(When you use the CD player on a flat and stable surface.)

Playing time varies depending on how the CD player is used.

When using	ESP		RADIO on
	on	off	
Two Sony alkaline batteries LR6(SG)	24	25	66

* Measured value by the standard of JEITA (Japan Electronics and Information Technology Industries Association).

**Charging time varies depending on how the rechargeable battery is used.

Operating temperature

5°C - 35°C (41°F - 95°F)

Dimensions (w/h/d) (excluding projecting parts and controls)

Approx. 161 × 26.3 × 130.3 mm

(6 3/8 × 1 1/16 × 5 1/4 in.)

Mass (excluding accessories)

Approx. 210 g (7.5 oz.)

Design and specifications are subject to change without notice.

Accessories (supplied/optional)

Supplied accessories

For the area code of the location in which you purchased the CD player, check the upper left side of the bar code on the package.

AC power adaptor (1)

Headphones/earphones (1)

Optional accessories

AC power adaptor	AC-E45HG
Active speaker system	SRS-A21
Car battery cord	DCC-E345
Car battery cord with car connecting pack	DCC-E34CP
Car connecting pack	CPA-9C
Connecting cord	RK-G129
	RK-G136
Earphones	MDR-E848LP
	MDR-EX70LP
Headphones	MDR-A44L
	MDR-A110LP

Your dealer may not handle some of the accessories listed above. Please ask the dealer for detailed information about the accessories in your country.

<http://www.world.sony.com/>

Sony Corporation Printed in China