

Portable CD Player

Operating Instructions

About the area code

The area code of the location in which you purchased the CD player is shown on upper left of the bar code label on the package.

For accessories supplied with your CD player, check the area code of your model and see "Accessories (supplied/optional)."



"WALKMAN" is a trademark of Sony Corporation.

D-EJ751

WARNING

To prevent fire or shock hazard, do not expose the unit to rain or moisture.

Do not install the appliance in a confined space, such as a bookcase or built-in cabinet.

To prevent fire, do not cover the ventilation of the apparatus with newspapers, tablecloths, curtains, etc. And don't place lighted candles on the apparatus.

To prevent fire or shock hazard, do not place objects filled with liquids, such as vases, on the apparatus.

Certain countries may regulate disposal of the battery used to power this product. Please consult with your local authority.

CAUTION

- INVISIBLE LASER RADIATION WHEN OPEN
- DO NOT STARE INTO BEAM OR VIEW DIRECTLY WITH OPTICAL INSTRUMENTS

Table of Contents

Getting started

Locating the controls	4
-----------------------------	---

Playing a CD

1. Connect your CD player.	5
2. Insert a CD.	5
3. Play a CD.	5

Playback options

Playing tracks repeatedly (Repeat play)	9
Playing a single track (Single play)	9
Playing tracks in random order (Shuffle play)	9
Playing tracks in your favorite order (PGM play)	10

Available features

G-PROTECTION function	11
Emphasizing the bass sound (SOUND)	11
Protecting your hearing (AVLS)	12
Locking the controls (HOLD)	12
Turning off the operation beep sound	13

Connecting your CD player

Connecting a stereo system	14
----------------------------------	----

Connecting to a power source

Using the rechargeable batteries	15
Using the dry batteries	17
Notes on the power source	17

Additional information

Precautions	18
Maintenance	18
Troubleshooting	19
Specifications	21
Accessories (supplied/optional)	22

Getting started

Locating the controls

For details, see pages in parentheses.

CD player (front)

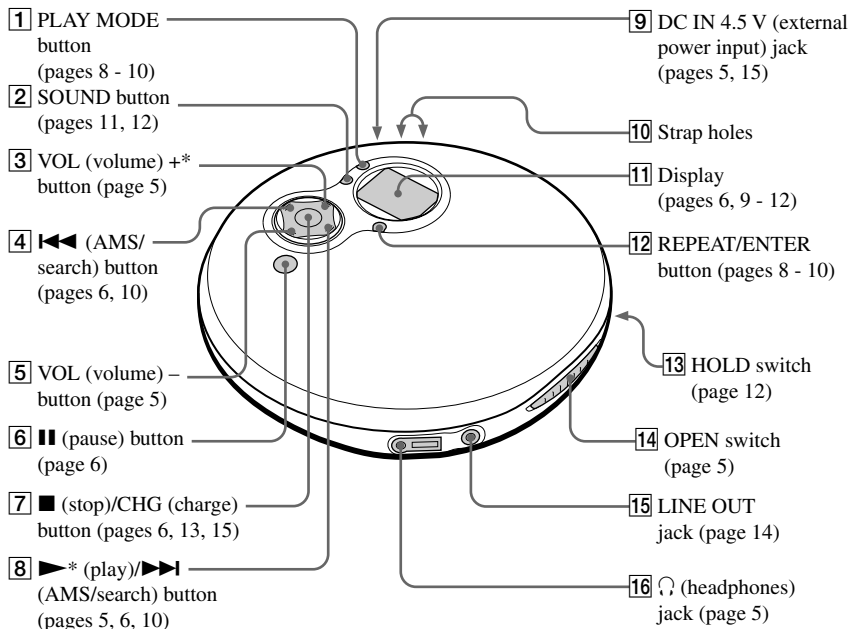

CD player (inside)

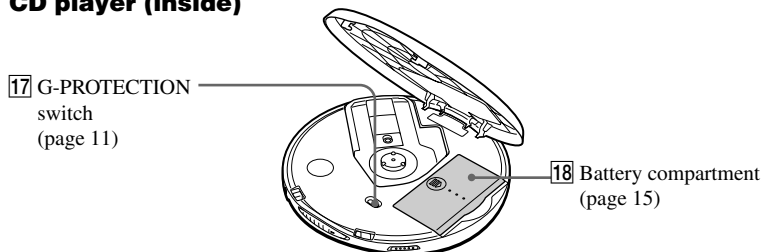

*The button has a tactile dot.

Playing a CD

You can also use rechargeable batteries or dry batteries as a power source.

1. Connect your CD player.

- 1 Connect the AC power adaptor.
- 2 Connect the headphones/earphones.

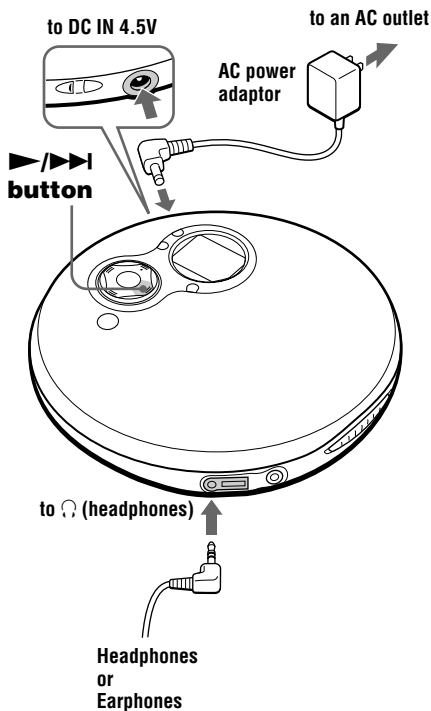

Playing a CD

2. Insert a CD.

- 1 Slide OPEN to open the lid.

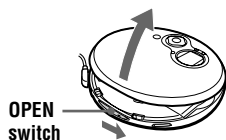

- 2 Place the CD on the tray and close the lid.

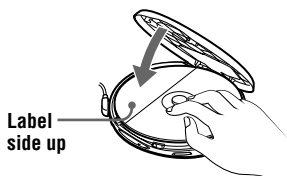

3. Play a CD.

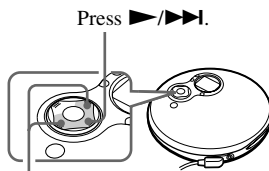

Adjust the volume by pressing VOL + or -.

To	Press
Play (from the point you stopped)	▶/▶▶
Play (from the first track)	▶/▶▶ for 2 seconds or more
Pause (on the CD player only)	
Stop	■/CHG*2
Find the beginning of the current track (AMS*1)	◀◀ once quickly*2
Find the beginning of the previous tracks (AMS)	◀◀ repeatedly*2, *3
Find the beginning of the next track (AMS)	▶/▶▶ once quickly*2, *3
Find the beginning of the succeeding tracks (AMS)	▶/▶▶ repeatedly*2, *3
Go backwards quickly	Hold down ◀◀*2
Go forward quickly	Hold down ▶/▶▶*2

*1 Automatic Music Sensor

*2 These operations can be done during both play and pause.

*3 After you have played the last track, you can return to the beginning of the first track by pressing ▶/▶▶. Similarly, if you are at the first track, you can locate the last track by pressing ◀◀.

About the display

- When you press ▶/▶▶ after changing the CD or turning off and on the player, the total number of tracks in the CD and total playing time appear for about two seconds.
- During play, the track number and the elapsed playing time of the current track appear.
- During pause, the elapsed playing time flashes.

If the volume level does not increase

- If “AVLS” flashes in the display, hold down SOUND until “AVLS” disappears from the display. For details, see “Protecting your hearing (AVLS).”
- If the headphones are connected to the LINE OUT jack, connect them to the  (headphones) jack.

About CD-Rs/CD-RWs

This CD player can play CD-Rs/CD-RWs recorded in the CD-DA format*, but playback capability may vary depending on the quality of the disc and the condition of the recording device.

* CD-DA is the abbreviation for Compact Disc Digital Audio. It is a recording standard used for Audio CDs.

Removing the CD

Remove the CD while pressing the pivot in the center of the tray.

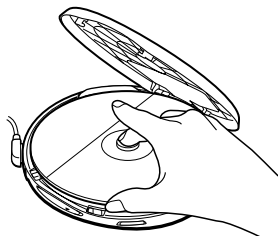

Playback options

You can enjoy various ways of playback using PLAY MODE and REPEAT/ENTER.

PLAY MODE button

Each time you press the button, you can change the playback mode.

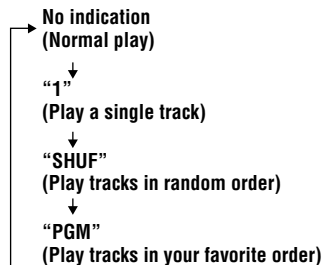

REPEAT/ENTER button

REPEAT

You can repeat play mode that was selected using PLAY MODE.

ENTER

You can select tracks for PGM play mode.

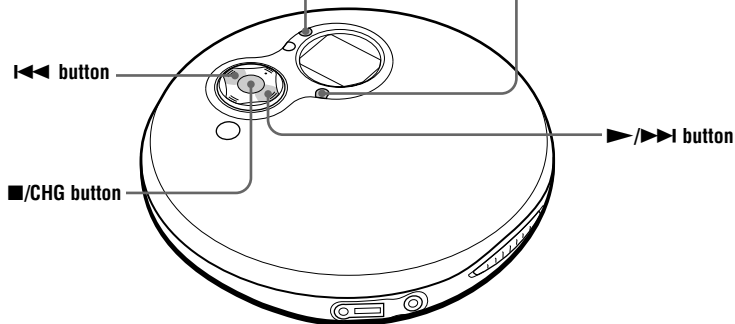

Playing tracks repeatedly (Repeat play)

You can play tracks repeatedly in normal, single, shuffle and PGM play modes.

During playback, press REPEAT/ENTER.

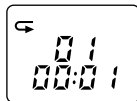

Playing a single track (Single play)

During playback, press PLAY MODE repeatedly until "1" appears.

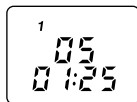

Playing tracks in random order (Shuffle play)

During playback, press PLAY MODE repeatedly until "SHUF" appears.

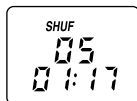

Playing tracks in your favorite order (PGM play)

You can program the CD player to play up to 64 tracks in your favorite order.

- 1** During playback, press **PLAY MODE** repeatedly until “PGM” appears.



- 2** Press **◀◀** or **▶▶** to select a track.

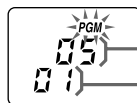

Track number

Playing order

- 3** Press **REPEAT/ENTER** quickly (less than 0.5 seconds) to enter the selected track.

“00” appears and the playing order increases by one.



- 4** Repeat steps 2 and 3 to select the tracks in your favorite order.

- 5** Hold down **REPEAT/ENTER** until play starts.

To check the program

During programming:

Press **REPEAT/ENTER** repeatedly before step 5.

During the PGM play:

Press **PLAY MODE** repeatedly until “PGM” flashes, then press **REPEAT/ENTER**. Each time you press **REPEAT/ENTER**, the track number appears.

Notes

- When you finish entering the 64th track in step 3, the first selected track appears in the display.
- If you select more than 64 tracks, the first selected tracks are erased.

G-PROTECTION function

The G-PROTECTION function has been developed to provide excellent protection against sound skipping while jogging. This function provides a higher level of shock protection than the traditional one.

Set G-PROTECTION (under the lid) to "ON."

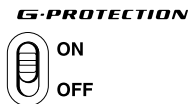

While jogging, be sure to hold your CD player with the OPEN switch facing upward.

To turn off the G-PROTECTION function

Set G-PROTECTION to "OFF."

Note

Sound may skip:

- if the CD player receives stronger continuous shock than expected,
- if a dirty or scratched CD is played or
- when using poor-quality CD-Rs/CD-RWs or if there is a problem with the recording device or application software.

Emphasizing the bass sound (SOUND)

You can emphasize the bass-boosted sound.

Press SOUND to select "BASS ■■" or "BASS ■■■."

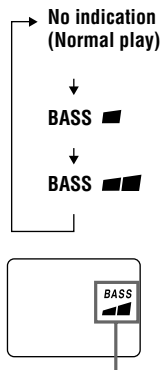

The selected sound mode is displayed.

"BASS ■■■" enhances the bass sound more than "BASS ■■."

Note

If the sound is distorted when using the SOUND function, turn down the volume.

Protecting your hearing

(AVLS)

The AVLS (Automatic Volume Limiter System) function keeps down the maximum volume to protect your hearing.

Press and hold **SOUND** until “AVLS” appears in the display.

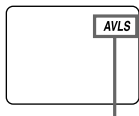

Flashes when the volume is turned up and beyond a certain level.

When you turn up the volume to “ $\bar{3}$ ”

“AVLS” flashes and you cannot turn up the volume any more. If you want to turn up the volume to more than “ $\bar{3}$,” hold down **SOUND** until “AVLS” disappears from the display.

Locking the controls

(HOLD)

You can lock the controls on your CD player to prevent accidental button presses.

Slide **HOLD** in the direction of the arrow.

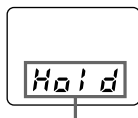

Displayed when the HOLD function is activated.

To unlock the controls

Slide **HOLD** in the opposite direction of the arrow.

Turning off the operation beep sound

You can turn off the beep sound that is heard from your headphones/earphones when you operate your CD player.

- 1 Remove the power source (AC power adaptor, rechargeable batteries or dry batteries) from the CD player.**
 - 2 Connect the power source while pressing ■/CHG on the CD player.**
-

To turn on the beep sound

Remove the power source and then connect the power source without pressing ■/CHG.

► Connecting your CD player

Connecting a stereo system

You can listen to CDs through a stereo system and record CDs on a cassette tape. For details, see the instruction manual that comes with the connected device.

Be sure to turn off all connected devices before making connections.

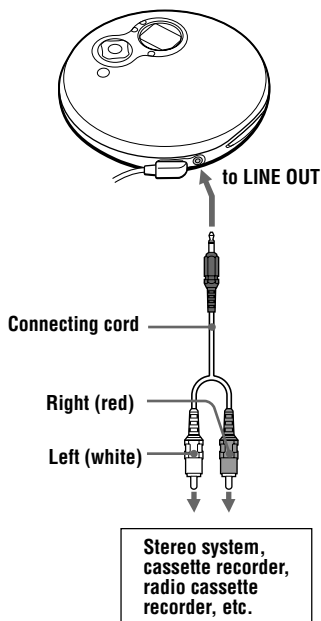

Notes

- Before you play a CD, turn down the volume of the connected device to avoid damaging the connected speakers.
- Use the AC power adaptor for recording. If you use the rechargeable batteries or dry batteries as a power source, batteries may become completely depleted during recording.
- Adjust the volume properly on the connected device so that the sound will not be distorted.

When using the connecting cord

If the sound is distorted, connect the device to the  jack.

About the G-PROTECTION and SOUND functions when using the connecting cord

- To record high quality CD sound, set the G-PROTECTION switch to "OFF."
- The SOUND function works only on the output sound from the  jack and not work on the output sound from the LINE OUT jack.

► Connecting to a power source

You can use the following power sources:

- Rechargeable batteries
- AC power adaptor (see “Playing a CD”)
- LR6 (size AA) alkaline batteries

For the battery life and charging time of the rechargeable batteries, see “Specifications.”

Using the rechargeable batteries

Charge the rechargeable batteries before using them for the first time. You can use only the following rechargeable batteries for your CD player.

- NC-WMAA
- NH-WM2AA (NH-WMAA × 2)

- 1** Open the battery compartment lid inside your CD player.

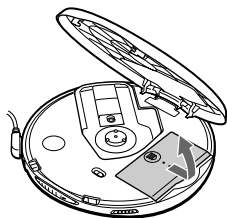

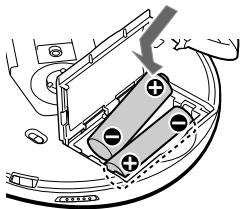

- 2** Insert two rechargeable batteries by matching the \oplus to the diagram in the battery compartment and close the lid until it clicks into place.

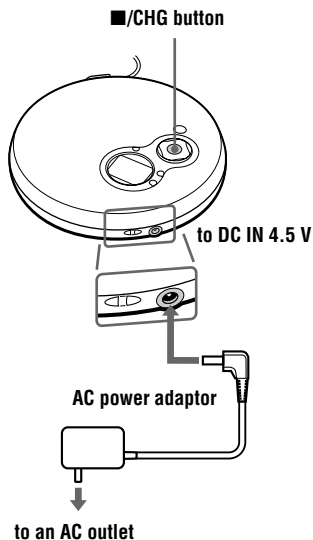

- 3** Connect the AC power adaptor to the DC IN 4.5 V jack of your CD player and an AC outlet, then press ■/CHG to start charging.



The CD player charges the batteries. The “CHG” indicator turns on in the display, and the indicator sections of  light up in succession. When the batteries are completely charged, the “CHG” and  indicators get turned off. If you press ■/CHG after the charge has already been completed, the  indicator flashes and “Full” appears in the display.

- 4** Disconnect the AC power adaptor.

(Continued)

Using the rechargeable batteries

To remove the rechargeable batteries

Remove the batteries as illustrated below.

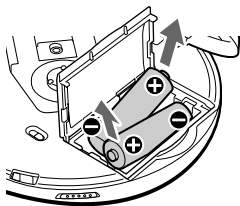

When to charge the rechargeable batteries

You can check the remaining power of the batteries in the display.

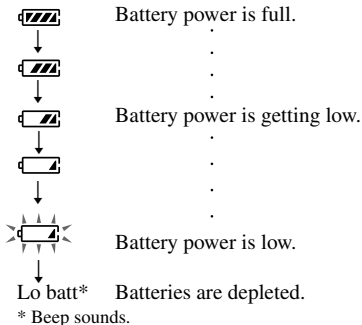

To keep the original battery capacity for a long time, charge the batteries only when they are completely depleted.

Notes

- The indicator sections of roughly shows the remaining battery power. One section does not always indicate one-fourth of the battery power.
- Depending on operating conditions, the indicator sections of may increase or decrease.

When to replace the rechargeable batteries

If the battery life becomes shorter by about half, replace the batteries with new rechargeable batteries.

Note on the rechargeable batteries

If the battery is new or has not been used for a long time, it may not be charged completely until you charge and discharge it several times.

Note on carrying the rechargeable batteries

Use the supplied battery carrying case to prevent unexpected heat. If the rechargeable batteries and the metallic objects get contacted, heat or fire may occur due to a short circuit.

To attach the battery compartment lid

If the battery compartment lid is detached by an accidental drop, excessive force, etc., attach it as illustrated below.

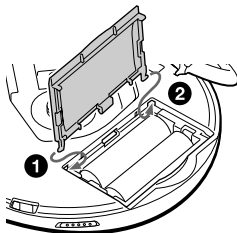

Using the dry batteries

Use only the following dry battery type for your CD player:

- LR6 (size AA) alkaline batteries

Note

Be sure to remove the AC power adaptor when using the dry batteries.

1 Open the battery compartment lid.

2 Insert two LR6 (size AA) batteries by matching the ⊕ to the diagram in the battery compartment.

To remove the batteries

Remove the batteries in the same way as rechargeable batteries.

When to replace the batteries

You can check the remaining power of the batteries in the display.

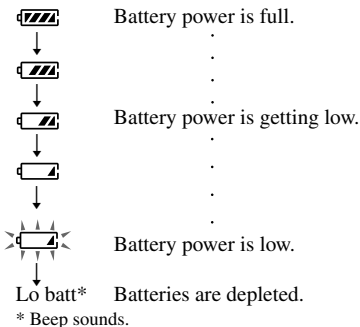

When the batteries are depleted, replace both batteries with new ones.

Notes on the power source

Disconnect all power sources when the CD player is not used.

On AC power adaptor

- Use only the AC power adaptor supplied or recommended in “Accessories (supplied/ optional).” Do not use any other AC power adaptor. It may cause a malfunction.

Polarity of the plug



- When disconnecting the AC power adaptor from the AC outlet, grasp the adaptor itself. Do not pull it by the cord.
- Do not touch the AC power adaptor with wet hands.

On rechargeable batteries and dry batteries

- Do not charge the dry batteries.
- Do not throw the batteries into fire.
- Do not carry the batteries with coins or other metallic objects. It can generate heat if the positive and negative terminals of the battery are accidentally contacted by a metallic object.
- Do not mix rechargeable batteries with dry batteries.
- Do not mix new batteries with old ones.
- Do not use different types of batteries together.
- When the batteries are not to be used for a long time, remove them.
- If battery leakage occurs, wipe off any deposit in the battery compartment, and install new batteries. In case the deposit adheres to you, wash it off thoroughly.

► Additional information

Precautions

On safety

- Should any solid objects or liquid fall into the CD player, unplug it and have it checked by qualified personnel before operating it any further.
- Do not put any foreign objects in the DC IN 4.5 V (external power input) jack.

On the CD player

- Keep the lens on the CD player clean and do not touch it. If you do so, the lens may be damaged and the CD player will not operate properly.
- Do not put any heavy object on top of the CD player. The CD player and the CD may be damaged.
- Do not leave the CD player in a location near heat sources, or in a place subject to direct sunlight, excessive dust or sand, moisture, rain, mechanical shock, unlevelled surface, or in a car with its windows closed.
- If the CD player causes interference to the radio or television reception, turn off the CD player or move it away from the radio or television.
- Discs with non-standard shapes (e.g., heart, square, star) cannot be played on this CD player. Attempting to do so may damage the CD player. Do not use such discs.

On handling CDs

- To keep the CD clean, handle it by its edge. Do not touch the surface.
- Do not stick paper or tape onto the CD.

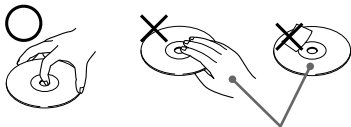

Not these ways

- Do not expose the CD to direct sunlight or heat sources such as hot air ducts. Do not leave the CD in a car parked under direct sunlight.

On headphones/earphones

Road safety

Do not use headphones/earphones while driving, cycling, or operating any motorized vehicle. It may create a traffic hazard and is illegal in some areas. It can also be potentially dangerous to play your headsets at high volume while walking, especially at pedestrian crossings. You should exercise extreme caution or discontinue use in potentially hazardous situations.

Preventing hearing damage

Avoid using headphones/earphones at high volume. Hearing experts advise against continuous, loud and extended play. If you experience a ringing in your ears, reduce volume or discontinue use.

Consideration for others

Keep the volume at a moderate level. This will allow you to hear outside sounds and to be considerate to the people around you.



Maintenance

To clean the casing

Use a soft cloth slightly moistened in water or a mild detergent solution. Do not use alcohol, benzine or thinner.

Troubleshooting

Should any problem persist after you have checked these symptoms, consult your nearest Sony dealer.

Symptom	Cause and/or corrective actions
The volume does not increase even if you press the VOL + button repeatedly.	<ul style="list-style-type: none">→ Press and hold SOUND until "AVLS" disappears from the display. (page 12)→ The headphones/earphones are connected to the LINE OUT jack. Connect them to the  (headphones) jack. (page 5)
Cannot adjust the volume.	<ul style="list-style-type: none">→ The headphones/earphones are connected to the LINE OUT jack. Connect them to the  (headphones) jack. (page 5)
No sound, or noise is heard.	<ul style="list-style-type: none">→ Connect the plugs firmly. (page 5)→ Plugs are dirty. Clean the plugs with a dry soft cloth periodically.
The playing time is too short when powered with the dry batteries.	<ul style="list-style-type: none">→ Check that you are using alkaline batteries and not manganese batteries. (page 17)→ Replace the batteries with new LR6 (size AA) alkaline batteries. (page 17)
The playing time is too short when powered with the rechargeable batteries.	<ul style="list-style-type: none">→ Charge and discharge the rechargeable batteries several times. (pages 15, 16)
"Lo batt" or "00" appears in the display. The CD does not play.	<ul style="list-style-type: none">→ The rechargeable batteries are used up completely. Charge the batteries. (page 15)→ Replace the batteries with new LR6 (size AA) alkaline batteries. (page 17)
"HI dc In" appears in the display.	<ul style="list-style-type: none">→ Use only the AC power adaptor or car battery cord in "Accessories (supplied/optional)." (page 22)→ Remove all power sources, then insert the batteries or connect the AC power adaptor again. (pages 5, 15 - 17)
The CD does not play or "no dISC" appears in the display when a CD is placed in the CD player.	<ul style="list-style-type: none">→ The buttons are locked. Slide the HOLD switch back. (page 12)→ The CD is dirty or defective. (page 18)→ Check that the CD is inserted with the label side up. (page 5)→ Moisture condensation has occurred. Leave the CD player aside for several hours until the moisture evaporates.→ Close the lid of the battery compartment firmly. (page 15)→ Make sure the batteries are inserted correctly. (pages 15 - 17)→ Connect the AC power adaptor to an AC outlet securely. (page 5)→ The CD-R/CD-RW was not finalized. Finalize the CD-R/CD-RW with the recording device.→ There is a problem with the quality of the CD-R/CD-RW, recording device, or application software.
"Hold" appears in the display when you press a button, and the CD does not play.	<ul style="list-style-type: none">→ The buttons are locked. Slide the HOLD switch back. (page 12)

(Continued)

Troubleshooting

Symptom	Cause and/or corrective action
The CD player does not start charging.	→ During stop, press ■/CHG. (page 15)
Playback starts from the point you stopped. (resume function)	→ The resume function is working. To start play from the first track, press ►/▶▶ for 2 seconds or more, or open the lid of the CD player. Or remove all power sources, then insert the batteries or connect the AC power adaptor again. (pages 5, 6, 15, 17)
Rustling noise is heard from the CD.	→ Close the lid of the battery compartment firmly. (page 15)
When closing the lid of the CD player, the CD starts to rotate.	→ The CD player is reading the information on the CD. It is not malfunctioning.

Specifications

System

Compact disc digital audio system

Laser diode properties

Material: GaAlAs

Wavelength: $\lambda = 780 \text{ nm}$

Emission duration: Continuous

Laser output: Less than $44.6 \mu\text{W}$

(This output is the value measured at a distance of 200 mm from the objective lens surface on the optical pick-up block with 7 mm aperture.)

D-A conversion

1-bit quartz time-axis control

Frequency response

20 - 20 000 Hz ± 1 dB (measured by JEITA CP-307)

Output (at 4.5 V input level)

Line output (stereo minijack)

Output level 0.7 V rms at 47 k Ω

Recommended load impedance over 10 k Ω

Headphones (stereo minijack)

Approx. 5 mW + Approx. 5 mW at 16 Ω

Power requirements

For the area code of the model you purchased, check the upper left side of the bar code on the package.

- Two Sony NC-WMAA rechargeable batteries: 2.4 V DC
- Sony NH-WM2AA rechargeable batteries: 2.4 V DC
- Two LR6 (size AA) batteries: 3 V DC
- AC power adaptor (DC IN 4.5 V jack):
U2/U/CA2/E92/MX2/TW2/BR3 model:
120 V, 60 Hz
CED/CET/CEW/CEX/CE7/EE/EE1/E13/G5/
G6/G7/G8/BR1 model:
220 - 230 V, 50/60 Hz
CEK/3CE7 model: 230 - 240 V, 50 Hz
AU2 model: 240 V, 50 Hz
JE.W/E33/EA3/KR4 model: 100 - 240 V,
50/60 Hz
HK2 model: 220 V, 50/60 Hz
AR1/CNA model: 220 V, 50 Hz

Battery life* (approx. hours)

(When you use the CD player on a flat and stable surface.)

Playing time varies depending on how the CD player is used.

When using	G-PROTECTION function	
	on	off
Two NC-WMAA (charged for about 3 hours**)	12	10
NH-WM2AA (charged for about 5 hours**)	25	22
Two Sony alkaline batteries LR6(SG) (produced in Japan)	48	38

* Measured value by the standard of JEITA (Japan Electronics and Information Technology Industries Association).

** Charging time varies depending on how the rechargeable battery is used.

Operating temperature

5°C - 35°C (41°F - 95°F)

Dimensions (w/h/d) (excluding projecting parts and controls)

Approx. $135.5 \times 29.2 \times 137.4 \text{ mm}$
($5 \frac{3}{8} \times 1 \frac{3}{16} \times 5 \frac{1}{2} \text{ in.}$)

Mass (excluding accessories)

Approx. 185 g (6.6 oz.)

Design and specifications are subject to change without notice.

Accessories (supplied/optional)

Supplied accessories

For the area code of the location in which you purchased the CD player, check the upper left side of the bar code on the package.

AC power adaptor (1)

Headphones/earphones (1)

Optional accessories

AC power adaptor	AC-E45HG
Active speaker system	SRS-T55 SRS-Z500
Car battery cord	DCC-E345
Car battery cord with car connecting pack	DCC-E34CP
Car connecting pack	CPA-9C
Connecting cord	RK-G129 RK-G136
Rechargeable battery	NH-WM2AA
Earphones	MDR-E848LP MDR-EX70LP
Headphones	MDR-A44L MDR-A110LP

When using optional headphones, use only headphones with stereo miniplugs. You cannot use headphones with micro plugs.

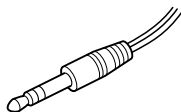

Stereo miniplug

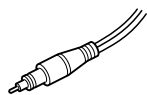

Micro plug

Your dealer may not handle some of the accessories listed above. Please ask the dealer for detailed information about the accessories in your country.

<http://www.sony.net/>

Sony Corporation