

# *Video Cassette Recorder*

---

ULM · t d √



Hi-Fi

*SLV-ED939SG*

*SLV-ED333SG*

# U d M Ł ` ' e ' t

fib0zU/ u ' α U e ' d q ' ~ b h A ' U H

uK q U

## SLV-ED939SG Ø'd

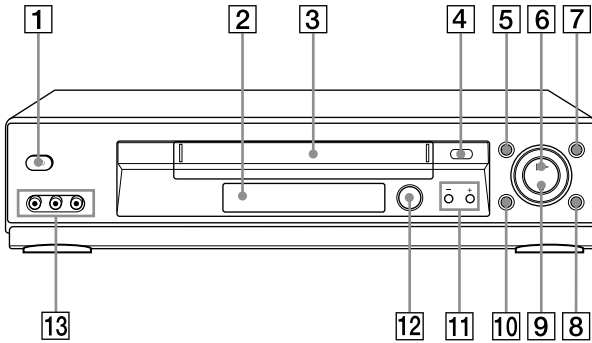

XA (†,.) 'n u\* ■ STOP tL **9**  
'bK

(†,.) (†·) ' U u ■ PAUSE tL **10**  
'bK XA α  
ØU tL **11**

PROGRAM/TRACKING +/-  
(†)\*'v U/t U d α

(-,) ' U ' ■ EASY TIMER **12**  
ØU tL **13**

LINE-2 IN VIDEO/AUDIO L/R 'bK XA α '†q,α' j ● REC tL **8**  
(‡) ' flX ' d uB fl'b Ø) L L † j

~Us 'L b/⏻ ON/STANDBY Oz **1**  
' U t

L' · · **2** M u M  
'u t **3**

(†,.) ' ~ L ⏏ EJECT tL **4**

(†,.) ' b ' ◀ REW tL **5**

(†,.) 'g \* ▶ PLAY tL **6**

(†,.) 'l d ~ ▶▶ FF tL **7**

L ■ STOP ◀▶ PLAY ØU tL \* ~

tDI p ■ PROGRAM/TRACKING +  
fibM v \*

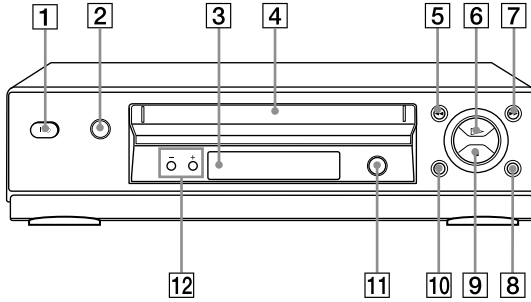

- 'bK XA' t, α • t- ' j ● REC tL 8
- 'bK XA' t, α (,) 'n u ■ STOP tL 9
- (t,) (t.) ' U u ■ PAUSE tL 10
- 'bK XA' α
- (-, ,,) ' U ' EASY TIMER 11
- ØU tL 12
- PROGRAM/TRACKING +/-
- (t) \* 'v U/t U d α
- p Ø PROGRAM/TRACKING + tL \*
- fib U v v \* tDI
- ~U s ' E t / ON/STANDBY Oz 1
- ' U t
- (t,) ' ~ E EJECT tL 2
- E ~ . . 3 M u
- 'u t 4
- (t,) ' b ~ REW tL 5
- (t,) 'g ▷ PLAY tL 6
- (t,) 'l d ~ FF tL 7

- (+.) ' √ E ▲ EJECT tL 1
- ' 0 √ E E " INPUT SELECT tL 2  
' bK XA α ' t α ' - . α
- 0' ∅ ' u z b u E e TV/VIDEO tL 3  
' u e u K
- (-.) ' √ d CLEAR tL 4
- \* t U d 0 √ b 5 tL √
- ' √ r / - α t L 6
- ' ' b VOL +/- 0 U tL 7 √
- ' t , ( ← ) ' j { ● REC tL 8
- ' j { X d REC SPEED tL 9
- (-+) ' " U ' X MENU U b tL 10
- (-+) ↑ / ' U u ■ PAUSE tL 11
- (+.) (-+) ↓ / ' n u ■ STOP tL √
- (-+) ← / ' b √ ◀ REW tL √
- (+.)
- (-+) → / ' l d √ d ▶▶ FF tL √
- (+.)
- (-+) \* ' b 0 / Q α ▷ PLAY/OK tL √
- (+.)
- ∧ AUDIO MONITOR ⇔ PLAY 0 U tL \* √
- f i b M v \* t D I P R O G 0 ' E ' √ U L

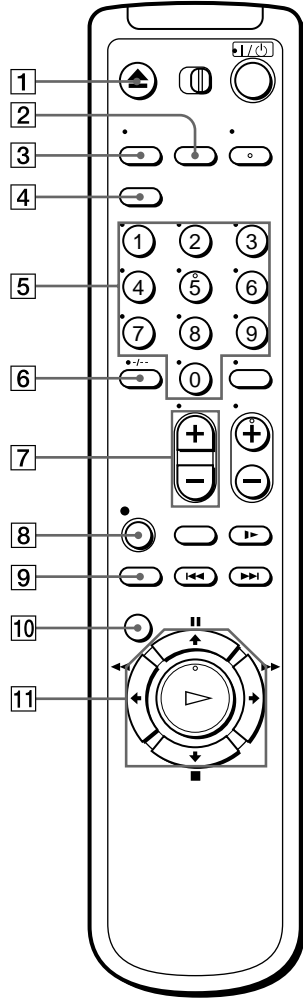

't' 12  
 •TV/VIDEO 13 M  
 u o AUDIO MONITOR tL 14  
 (-) 'd~A DISPLAY tL 15  
 -\*'t U PROG +/- tL 16  
 (t,) 't SLOW tL 17  
 (t,)x2 tL 18  
 ØU tL 19  
 INDEX SEARCH  
 'd~ UA Øu

Ozu

AUDIO MONITOR ▷ PLAY ØU tL\*  
 fibM v \* tDI PROG Ø' Ø' UL  
 SLV-ED939SG b 1

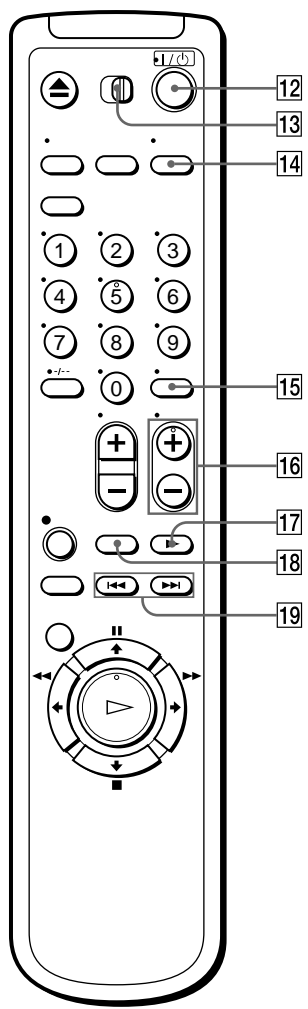

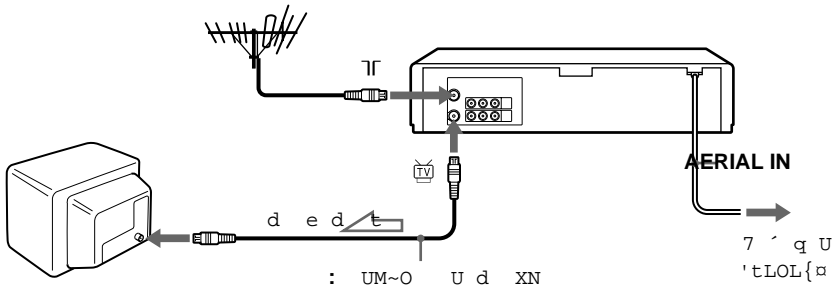

**1**

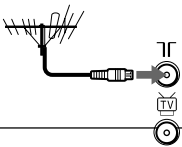

· ' E ~u/ · b ~u u e uK · · 7 ' q U  
 fibOM q E uzb E U~ 7' XIA t ~ l ' E

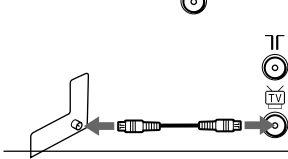

uzb E U <tLOL{ 7 ' q U · ~UH **2** U  
 fibOM q E rN · ~u u e uK 7 ' Ø~E E E

fibOM q E d e d t · d **3**rO

v U <bOM v qB r t 7 ' q U p tKO E t UNM · ~u u e u  
 fi'bOM tE, t H α bozU/ roEM uzb E U~ ~ ØE d · ~u

v U{ . ° UB .

SLV-ED939SG Ø'd

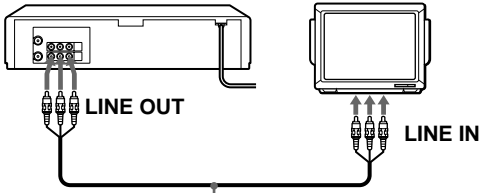

'X O tLOL{ad' bB q U

gO ØU tU t v u e uK t  
v . v Ød /wBu Øv L L  
d uB L . b XOHO v U{ . UB . s  
t . u e uK fibA v v u N  
b v . v UA XL v tJO u  
fibOzU/ q L X .

SLV-ED333SG Ø'd

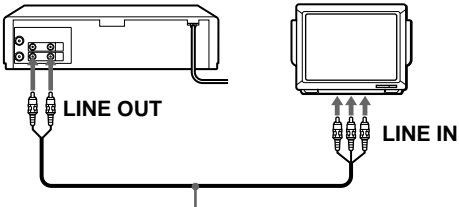

'X O tLOL{ad' bB q U

U ~u rOEM ~dJKL · ~UH · U

s · · ~UH · U fibOzU/ rOEM U ~u rOEM · ~UH · U ·  
sOOF U ~u u t · u e uK ØUN U U £ u e uK t H ØL g  
fibOM

fibO ~ 'd uzb £ U U ØL d 'd ' £ ~u/ **1** s £ ·  
Ø'd fibO ~ 'd 'uzb £ U~ ~t\$ 'UØUd ØH dd U U use ØK α  
.bOM tF 'd ' ØULM · qLF · u ~ t ~u u e uK rOEM t u



fibOM qB d e d t · U~ **2** d ro  
fi~u v s £ ~u t ~u uzL £ U~ ~  
ØL LANGUAGE SET "U · X d  
fi~u v d U u e  
~ u U "U ←/→ 'dL ~  
~ · ~ ARABIC ENGLISH < · u) ~  
fibO ~ **OK** f £  
v d U U ~u rOEM ~dJKL ~ u ~ v UGO  
fi~u

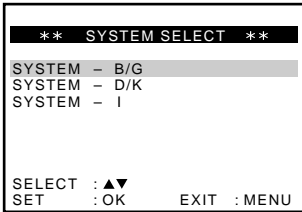
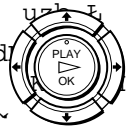

.bo ~ uOK tL ~ **3**  
SYSTEM SELECT "U · X d  
~ ~d v d

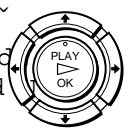



r O "U ↑/↓←/→ tL ~  
UA OK f E ~ ~ UA V UM uK  
fibO ~

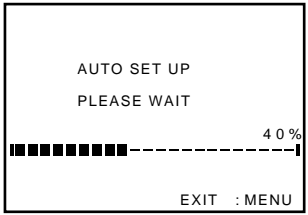

q U ØU U U U9 Ø'd u Ed uzb  
V UM t v O d t α · UN E ~d X U  
fib U/ v rOEM gO 'b U v UL tIDM

t U d ØU XOF u bO 'u v UL d ·  
XOF u Æc g <bOzU/ Æc · t 'u U  
tE -·t H ~ t 'u U t U d ØU  
.bOM

~ X U rOEM g fi~u v d U X U rOEM ØuM <b q U u  
.bOM tE - t'H

U ~u rOEM ~dJKL uG Ø'd  
.bo ~ MENU tL ~

d · fib u v aU ' dO <dL U α 'ULOEM · v d <bo ~v U\$' · U  
fibOzU/ rOEM · UN ' U E ~ v U b ' go  
U~ ~ b d · bF U sO E' Ø'd UL t ~u v Ed pO U u ' u  
fibOM v q E d e d t 'd' uzb  
bOM v qB e d t · U~ ~ d rO U E ~ UL t · v U~M < U ~u  
· d~ U bo 'u v t UM fiLANGUAGE SET UUu · · x dn  
b U U↑/↓←/→f MENU tL ~ <bOM ~UH · U ~u rOEM ~d  
AUTO SET UP b U↑/↓UtL ~ fibO OK E A ~"INSTALLATION  
fibOM †dJb · ØUNKLF · u ~ v U9 f E ~ ~  
v U~M <d AO 'b STOP ~ ~ UA U b 'u v · U ~u rOEM  
fi~d c U\$' <X O U~ ~ q ~ Ø 'u

# X U rOEM

uzb Ł U~ ~ ØŁ a U Ł U v U bOzU/ ~UH · V UM u  
 .bOM rOEM

fififi Łd · q

fibOzU/ s Ł · u e uŁ Ł uzb

fibOM rOEM uzb Ł U ØŁ ·

fibOM tF `d U d M Ł `e · tLOL{ g t U

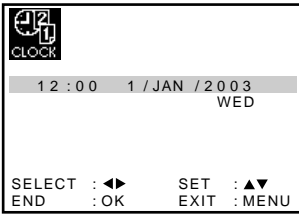

Ø U tL ~ MENU <tL ~ MENU **1**

U ~ ~ **↑/↓ ←/→**

· OK tL ~ Ł **CLOCKSET**

fibO ~ U

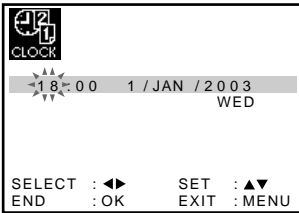

fibO ~ UA X U ~ d **↑/↓** rOEM d **2**

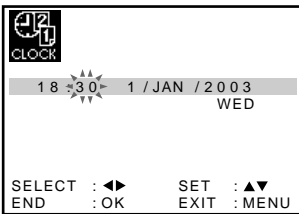

f Ł ~ ~ UA tIO → "U Ø`d **3** ·

rOEM **↑/↓** ØU tL ~ ~ U

fibOM tIO ~

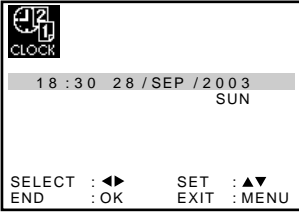

↑/↓ →      ~ ~      UA U VO d t      U E 4 U < :  
ØU tL ~ L < ~ u d ~      · Ø·d  
~ ~      UA t f u Ed U · ~ t      d  
fibOzU/ → OEM

fi ~ u v r OEM U ~ u u t t H E

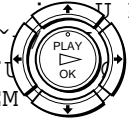

fibO ~ UA ~ U · X dN MENU EdL Ø· MENU



5

U U U ~d r

rOEM v ~ · u t · UN ´ bO ´ u v UL <BA rOEM U ~u rOEM fibOM

fififi Ed · q

fibOzU/ s L · u e uK L uzb

fibOM rOEM uzb L U ØL ·

fibOM tF ´ d U d M L ´ e ´ tLOL{ g t U

**INSTALL**

AUTO SET UP  
MANUAL SET UP  
TV SYSTEM : G  
VCR OUTPUT CH : 32

SELECT : ▲▼ SET : ►  
END : OK EXIT : MENU

Ø U tL ~ f < MENU **↑/↓** · MENU **1**

U ~ · **↑/↓** **←/→**

· OK f L b INSTALLATION fibo ~



**\*\* TV STATION TABLE \*\***

PR	CH	NAME	SYSTEM
1	027	AAB-	B/G/D/K
2	029	LMN-	B/G/D/K
3	030	CDE-	B/G/D/K
4	032	IJK-	B/G/D/K
5			

▲▼ ► SWAPPING : OK  
DELETE : CLEAR EXIT : MENU

MANUAL SET UP U ~ · **↑/↓** **←/→** **2**

fibo ~ **←/→** f · L b

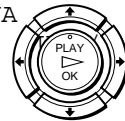

**\*\* MANUAL TUNING \*\***

SYSTEM : B/G/D/K  
PR : 5  
CH : ---  
MFT : -  
NAME : ----

SELECT : ▲▼ SET : ◀▶  
END : OK EXIT : MENU

bO ´ u v t vH ~ **↑/↓** **←/→** **3**

fibo ~ **←/→** f · < · ~ · UA

t u d ´ U H d U L · Ø · d

· dJ **↑/↓** < U t U d ØU XGJ u

fibo ~ UA



**\*\* MANUAL TUNING \*\***

SYSTEM : B/G/D/K  
PR : 5  
CH : 033  
MFT : -  
NAME : ----

SELECT : ▲▼ SET : ◀▶  
END : OK EXIT : MENU

· u) ~ U U b d d **←/→** **4**

fibo ~

· u e uK V UM r O u ~

fibOM "U

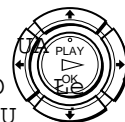

**\*\* MANUAL TUNING \*\***  
 SYSTEM : B/G/D/K  
 PR : 5  
 CH : 033  
 MFT : 7  
 NAME : \*---  
 SELECT : ▲▼ SET : ◀▶  
 END : OK EXIT : MENU

E b NAME U ~·↑/↓JA  
 fibO ~ f·



5

**\*\* MANUAL TUNING \*\***  
 SYSTEM : B/G/D/K  
 PR : 5  
 CH : 033  
 MFT : 7  
 NAME : \*---  
 SELECT : ▲▼ SET : ◀▶  
 END : OK EXIT : MENU

fibOM ~·E· U·  
 fibO ~ UA d·U↑/↓1  
 t d·U <bO↑tv UUA d·  
 fibM v dOOG b ~·~ UA  
**1 ← 0 ← Z ← ... ← B ← A**  
**A ← 9 ← ... ←**

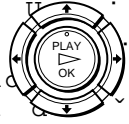

6

fibO ~ UA ØbF d· →2 sOOF Ø'd·  
 fib v pLA ØbF d·U ØU  
 'O B bO 'u v t Ød ~·~tJØU~MUUp· 'O B Ø'd  
 fibOM sOOF 'd· U E~ f E bO ~ UA be pLA  
 fibOM ~UH· d d'b' U U~ · U Ø'd bo 'u v UI

fibO ~ ~~OK~~ U~ · U bO Ø'1



7

fibO ~ UA "U · X dN MENU EdL Ø'd MENU  

8

· U ~u tIDM UK'G a' u e uK r O <X· uAG U ~·d u e uK Ø  
 fibOzU/ "U ·

't U ~α U U U ~d

'u)~ dO ØU t U d Æc

UL t v U~M ' f fibOzU/ Æc ' bA ~UH ' t U d ØU  
fib b 'u d b Æc t U d ØU XOF PROG+/- ØU bçL' v

**INSTALL**

AUTO SET UP  
MANUAL SET UP  
TV SYSTEM :G  
VCR OUTPUT CH :32

SELECT :▲▼ SET :▶  
END :OK EXIT :MENU

Ø U tL ~ f <MENU UA ~·MENU **1**

U ~···↑/UA/→

·OK f L b INSTALLATION fibO ~



**\*\* TV STATION TABLE \*\***

PR	CH	NAME	SYSTEM
1	027	AAB-	B/G/D/K
2	029	LMN-	B/G/D/K
3	030	CDE-	B/G/D/K
4	032	IJK-	B/G/D/K
5			

▲▼▶ SWAPPING :OK  
DELETE :CLEAR EXIT :MENU

MANUAL SET UP U ~··↑/UA **2**

fibO ~ → f' L b

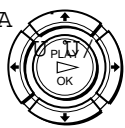

**\*\* TV STATION TABLE \*\***

PR	CH	NAME	SYSTEM
1	027	AAB-	B/G/D/K
2	029	LMN-	B/G/D/K
3	030	CDE-	B/G/D/K
4	032	IJK-	B/G/D/K
5			

▲▼▶ SWAPPING :OK  
DELETE :CLEAR EXIT :MENU

bO 'u v t vH ~ ↑/↓ **3**

fibO ~ UA bO M PLAY/OK

t u d 'UH d U bO d Ø'd

° dJ ↑/↓, U t U d ØU XOF u

fibO ~ UA



**\*\* TV STATION TABLE \*\***

PR	CH	NAME	SYSTEM
1	027	AAB-	B/G/D/K
2			
3	030	CDE-	B/G/D/K
4	032	IJK-	B/G/D/K
5			

▲▼▶ SWAPPING :OK  
DELETE :CLEAR EXIT :MENU

fibO ~ CLEAR tL ~ CLEAR **4**

XL ~ tJO u t b ..U : n ~

fi ~d v 'aU b ~··· UA



'dJ bOM Ac bo 'u v t Ød~ ~ t U d. fOU XOF u . 5 b d  
fibOzU/

fibO ~ UA "U . X dN MENU EdL Ø. MENU 6



U U~ . U d  
fibOzU/ ~ 'EU'dd .. b a U L ~ ~ doOG . U

fififi Ed . q

fibOzU/ s L . u e uK E uzl

fibOM rOEM uzb E U ØE

fibOM tF 'd U d M E `e ' tLOL{ g t U

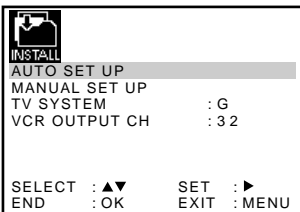

Ø U tL ~ f < MENU UA ~ . MENU 1

U ~ ~ ↑/↓ ←/→  
OK f E b INSTALLATION  
fibO ~ UA

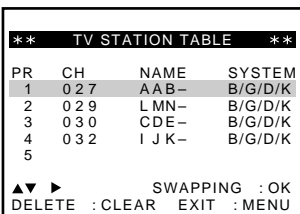

MANUAL SET UP U ~ ~ ↑/↓ UA

fibO ~ → f . E b

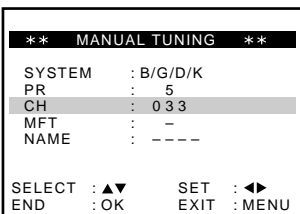

U bo 'u v t vH ↑/↓ b ~ ~ U / U 3

< ~ ~ UA bOzU/ ~ E U doOG  
fibO ~ → f .

t u d 'U H d U b d U Ø'd

o dJ ↑/↓ < U t U d ØU XOF u  
fibO ~ UA



**\*\* MANUAL TUNING \*\***

SYSTEM : B/G/D/K  
 PR : 5  
 CH : 033  
 MFT : 7  
 NAME : \*---

SELECT : ▲▼      SET : ◀▶  
 END : OK        EXIT : MENU

£ b NAME U ~·↕/JA  
fibO ~ ➔ f·

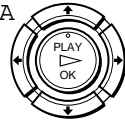

4

**\*\* MANUAL TUNING \*\***

SYSTEM : B/G/D/K  
 PR : 5  
 CH : 033  
 MFT : 7  
 NAME : \*---

SELECT : ▲▼      SET : ◀▶  
 END : OK        EXIT : MENU

fibOM ~ ·£·  
 fibO ~ UA d · U ↕/1  
 t d · U <bO ↕ tv UUA  
 fibM ~ dOOG b ~·· UA d·

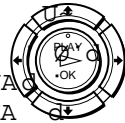

5

1 ← 0 ← Z ← ... ← B ← A  
A ← 9 ← ... ←

fibO ~ UA ØbF d · ➔ 2 sOOF Ø·d ·  
fib v pLA ØbF d · U ØU

'O B bO ·u v t Ød · ↕/➔ JQ d U~M U U p · 'O B Ø·d  
 fibOM sOOF ·d · U £· f £ bO ~ UA b e pLA  
 fibOM ~UH· d d·b· W U~ · U Ø·d bO ·u v UL

fibO ~ UA b b OK hOzQ Ø·d ·

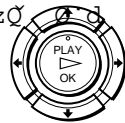

6

fibO ~ UA ··U · X dN MENU HCL Ø MENU ·



7



v u e uK ØU t U d

fififi Ed ' q  
fibOM tF 'd U d M E 'e ' tLOL{ g t U

fibOzU/ rOEM uzb E U U ØE 'd 'E 'u/ 1 E .

fib 'c~ uzb E q ' b U bA t J ' t vM 2 . U

t U d XOF u UPROG Ø-U t L Ũ <Ø'U t U d • p j PROG Ø' d 3  
fibO ' UA 'u d U g U/ t H ( + ) 'u) ✓  
( - )  
INPUT SELECT

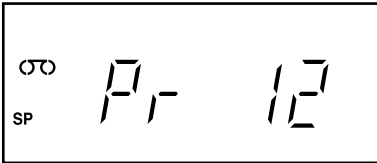

qB LINE ØU Ø' E E ' Ø' bF U p t t v z UN U~ ' d U  
g U/ t H ØE UB ' j INPUT SELECT Øb 'U v  
fibO ' UA 'u d U

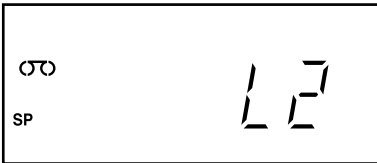

fibO ' UA 'd j { ● REEd t L Ø' d ● REC 4

fi' u v s E g U/ t H ØE j { d~ (UA) e d ' d



'd j { h U

't U ~ a v u e uK ØU t U

j { 7 U n u Ø'd  
fibO ~ ■ASTOP tL ~

b U v U U v d Ø'd  
d · u t d~A U/ DISPLAY tUA U d DISPLAYAL ~  
fibM v dOOG

U d~ UL L 'u X d <t U d XOF u <r O @ < u e uK  
U d~ UL L <vKF ←U b U av ←U U

"U · X d TAPE SELECT tJM · · < b U v U U g U/ 'O X U  
fibOM q U UMOL · b U b sOOF USER SET · ~ u 'u

~d j { U~M t d~ ~ v u e uK t U d p Ø

u e uK Ø~L L ØL · u e uK <Xb· qBU üz b U 1 u u u ·  
fib u ~ tK d s · · <X · b q L uzb L t 7 ' q U U jI

fibOM "U · u e uK ØL 2 Ød~ ~ t U d

b j { 'u p ~d kH

vML · U < b j { 'u p v UH · b aU  
< 'u s · ØL d U L ~ ~d j { Ø'd fibOMJA  
fibO U u V 'u U · vML · U

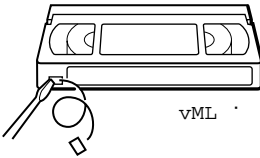

vML · U

U ' dL U ~dJKL . ~UH . U v u

I/O ON/STANDBY PROGRAM +/- ■ STOP



EASYTIMER || PAUSE

Eb t b ~ v UL t . UJ ' s  
 fibO ~ U\$ . U t Ud v U j {  
 t Ud XA U d ' b ~ d j { Ø.  
 Eb ' b rOEM dL U ØUN L d U U  
 U fibOM rOEM <b u v g  
 p q ' u t bM ' u v g n u U  
 fib u rOEM Ø' t

U u ' d AO ' u U ' b t b u s LD fib ' c~ uzb P q ' v h  
 fib U j {  
 fibOzU/ tF ' d U d M L ' e ' tLOL{ g t

fififi Ld ' q

fibO ~ ~~EASY TIMER~~ tL ~ EASY TIMER

1

fib bM ' u d U g U/ t H Ø TODAY DATE t~ UA  
 Ø' d ØbF + gK d fi ~ d DAY dbM U bA rOEM U a U d .  
 fibOzU/ tE ' a U L U rOEM Ø' d X U



fibO U d ~ d j { a ~~EASY TIMER~~ tL ~ EASY TIMER

2

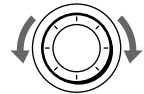
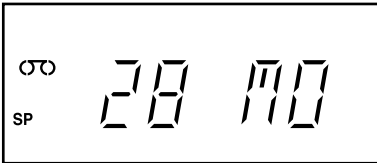

fibO U d j { E d U EASY TIMER d L ~ EASY TIMER

3

fib u v d U d A U / t H START { U ~ U A

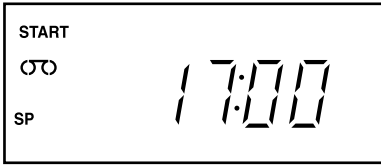

17:00

fibO U d j { E d U EASY TIMER d L ~ EASY TIMER

4

Ø U t L ~ ~ ~ U A - U q U ' u E Ø t I O j { E d U U ~ U v U L  
fibO z U / r O E M t I O ~ p b PROGRAM U / - U

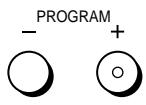
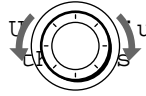

18:00

fibO U d j { E d U EASY TIMER d L ~ EASY TIMER

5

fib u v d U g U / t H Ø L STOP r d ~ U A

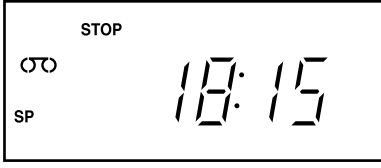

18:15

fibO U d j { n u EASY TIMER d L ~ EASY TIMER

6

Ø U t L ~ ~ ~ U A - U q U ' u E Ø t I O j { n u U U ~ U v U L  
fibO z U / r O E M t I O ~ p b PROGRAM U / - U

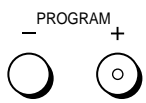
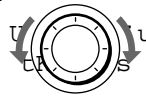

19:00

fibO ~ EASY TIMER tL ~ EASY TIMER **7**

fib u v 'b b g LINE 0~L0L U t U d

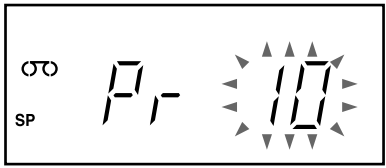

fibO U d t U d XOEASY TIMER 0Ld ~ EASY TIMER **8**

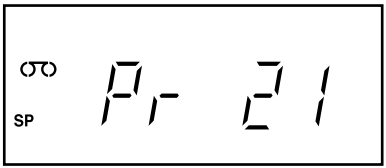
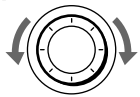

v qBLINE 0U 0~L E L ' 0~'bF U p t t vz UN U~ ~ d U .  
U bo ~ INPUT SELECT U L bEASY TIMER tL ~ <bM U  
fi~u d U g U/ t H 0L b qB j UL

fibO ~ EASY TIMER tL ~ EASY TIMER **9**

fi~u v d U g U/ t H 0L 'u

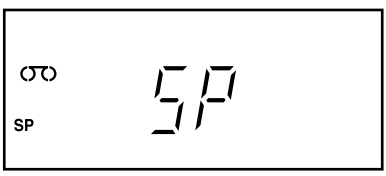

AUTO LP SP 0L d 'u X d EASY TIMER dL ~ EASY TIMER **10**

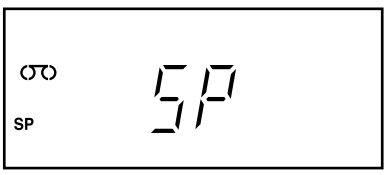
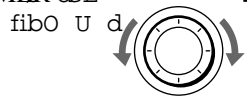

~ ~ t U ~

fibO ~ UA °ULOEM EASY TIMER tL ~EASY TIMER

11



fi~u v d U g U/ t H°bØLØ ØK U

j { Ø'd U ~U ' X U ~ uzb L U~ Ø E~ bUA g U/ t H ØL

fi~dO v 'd ~d

fib 'c v U s L X U t · dE ~ u b qB tKO L <d~ ~ tKO L

vK tK d t XA U Ø'd

ØU tL ~ U ' dL U °ULOEM q'd · p d ~ vK t

fibO ~ UA uzbeL U~ - PROGRAM +

~d j { n u Ø'd

fibO ~ **STOP** tL ~ <j { U~M ~uzb L U~ ~ n u

dL U °ULOEM U\$' bF uzb L U~ ~ · ~UH

u U ⊙ d~ UA fibO/⊙ XUA U UNM <j { Ld · q uzb L U~ ~ ·

I/⊙ tL ~uzb L U~ ~ · ~UH · · f t bO U t · ~U t fi~

fibO ~ UA <j { Ø'd U ~U ' X U t uzb L U~ ~

"bo ~ U\$' X · ~d j { U ~ uzb L U~ ~ tJO U ~ · d Ø

fid~ UL ~d· dH

fi±, t H α u e uK t H ØL 'u t· ud °U ·

fidL U °ULOEM v d

fi±, t H αd~ ~ v u e uK t U d p ØU U

'u pO U u · X d ~dJKL · ~UH · Ø

U ~ UL t v U~**AUTO**fibO U d **EASY**TIMER < u tk d ~

v ~d j { U ~ d U u · **SP** XØFØL v UØ · U UEdbo ~d j {

j { U ~ t **ER** XØFØL **LIP** XØFØL t pO U u · u t 'u j { X d

b U v dOOG 'u X d t v U~M t **OSC**/ØUNuUM~fib U v dO

~TAPE SELECT rOEM <qL s · 'O U\$' Ø'd fib ' v b b d u

fi~d c · u 'O · u **USER** SET UU · X dN

X U rOEM Ø'd

fi~u d U g U/ tDAY Ød~ UA U t EASYTIMER tL 1  
fi~d v d U ~u u rOEM b U b U\$ X U rOEM

fibO U d E sEASYTIMER tL 2

fibO ~ EASYTIMER tL 3

fib u v d U g U/lt MONTH d~ UA

fibO U d U f E EASYTIMER tL 4

fi~u v d U g U/ CLOCKØd~ UA <b ~u/ rOEM U tJ ' .

fibO ~ UA E b U d tIO EASYTIMERØEM 5'd .

U t E dEASYTIMER tL ~ <b b U U U t . 6 U rOEM t

fibO ~ UA X U

t u ~ u 'UJ

fibO ~ UAzb'E U~ ■STOP <'ULOEM s' U\$' U~M ~ U' dL U 'ULOEM

t v u ~ v LEbØM dOEM ER XØFqLNTSC ØUN UM~O j·{ Ø'd

j {EP XOF{E t pO UNTSC ØUN tUM~O <b ULP XØF{ØEM j { dL U

fib uAO

'U O{u

<bM U bTIMERPROGRAMMING "U ' x dN ' ~UH ' tU UM U d XA

fi~d v d U g U/ t HØLØL' bFULL @ UA

ØL Ø d~ UA <bO U ~' U\$' uzb-EtK~d 'u~ Ø 'cULOEM EBL t v U~M

fib v pLA g U/ t H

ØL ERROR d~ UAtK d ~ <b U t d 'u 'O U ' u t U rOEM

fibOzU/ rOEM °~btK d dLU fi~u v d U g U/ t H

't U ~a U ' dL U ~dJKL ' ~UH ' U v u

g U/ XOF{L ~ u ~

U b ~ v UJ ' < bM Ed qO ' < bMM ~UH ' t t b U v  
<XOF{L s ' fib U/ ~ 'L ' dL U rOEM ~ u XA ' gO b ~ v g  
v U j { U\$' Ø'd g U/ XOF{L ' fib U/ v uG FULLu d~ UÅ U t  
fi~d 'O dO ØU rOEM t d M X ' sJ2 XOF{L s '

g U/ XOF{L ~d UF Ø'd

d~ UA fibEASYTIMER 'ULOEM uzb~L' U~ **PAUSE** tL ~  
fi~u v d U tO U bM Ø'DEMO U/ t H ØL

g U/ XOF{L uG Ø'd

U ' ~d v uG g U/ XOF{L t d ' fibOM U e d ' ' d r  
dL U ' ~UH ' ' q fib U bM 'u v U g U/ XOF{L ' ' ~UH  
v ~ ' u t dL U 'ULOEM uG ' < d rO ~b UB ' ' f d~  
fibOzU/ q U UMOL '



dL U ' ^UH ' U v u e uK

fibOzU/ rOEM gO ' <dL U ØU È d U U b U\$' ØU rOEM

fififi Èd ' q

fib U b rOEM 'O a U È U ØÈ uezb•È U~

U u ' d AO 'u U 'b t b u s LD fib 'c~ uezb È q ' ^ b

fib U j {

fibO ' d uezb È U U ØÈ ' ' È 'u

fibOzU/ tF 'd U d M È ``e ' tLOL{ g t

PR	DAY	START	-STOP
---	---	---	---
---	---	---	---
---	---	---	---
---	---	---	---
---	---	---	---
---	---	---	---
---	---	---	---
---	---	---	---
---	---	---	---
---	---	---	---

SELECT : ▲▼      SET : ◀▶  
END : OK          EXIT : MENU

UA ↑/↓/←/→ f MENU tL ^ MENU **1**  
 TIMER PROGRAMMING U  
 fibO ^ OK È'u U U/



PR	DAY	START	-STOP
---	---	---	---
---	---	---	---
---	---	---	---
---	---	---	---
---	---	---	---
---	---	---	---
---	---	---	---
---	---	---	---
---	---	---	---
---	---	---	---
---	---	---	---

SELECT : ▶      SET : ▲▼  
END : OK          EXIT : MENU

'u X d È n u È Èd ØU  
 "bOM sO  
 UA X u t ^ u d → U  
 fibO ^  
 fibO ^ UA ^ u d / rOEM INP d  
 XA U Ø ← <rOEM p 'O B SELECT  
 fibO ^ UA ^ b rOEM È rOEM ' t

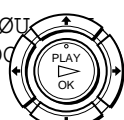

v~ È ' È j { g <t H ^ vN UA È U È È d ^ Ø' t U  
 fibOzU/ tÈ t H  
 LINE Ø È È bM U p t qB ØUN U ^ d U ' j { Ø  
 fi ^ d dPR XOF u ^ b qB jINP SELECTUA

fibO ^ UA "U ' X dN MENU Èd Ø MENU **3**



---

fi~u u U uzb L U~ I/O UA 4  
j { Ø'd U ~U ' X U ~ uzb L U~ Ed~WA g U/ t H Ø  
fib 'c v U s L X U t · dE ~ u b qB tKO L <d~ ~ tKO L

---

fibO ~ ■ASTOP < ~d j { ~ uzb L U~ ~ 7 U n u  
v~ H/t · L j {  
t d~ UA <b~ t UAJ d fibo ~ UA j ~ t d' Ø'd ·  
fibO ~ UA fJ VO d t fibOG v Ø'd OG d ~ b ~ UA  
← fififififi ' W-SA ← t MAJ U DLY ← U a U  
Ø U a ← ' a U uJF ← U pt MAJ W-SU

dL U roEM · bF uzb L U~ · ~UH  
u U ⊕ d~ UA fibO XUA U UNM <j { Ed · q uzb L U~ ·  
I/O tL ~uzb L U~ · ~UH · f t bo U t ~U t fi~  
fibO ~ UA <j { Ø'd U ~U ' X U t uzb L U~  
"bo ~ U\$' X · ~d j { U ~ uzb L U~ ~ tJO U ~ · d Ø

fid~ UL ~d· dH  
fi±, t H α u e uK t H ØL 'u t· u d 'U ·  
fidL U 'ULOEM v d  
fi±, t H αd~ ~ v u e uK t U d p ØU U  
'u pO U u · X d ~dJKL · ~UH · Ø  
t U d ~d j { U ~ UL t AUTO~M fi~ UAJ tK'd ~  
j { X d <~d v ~d j { U · d U SP XOE{L b'UØ'v U U  
NTSC ØUN UM~O j { U EP XOF{L LP XOF{L t pO U u · u t 'u  
b b d uB ØL v U UA · b U v dOOG 'u X d t v U~M t bo  
"U · X d TAPE SELECT roEM <qL s ' 'O U\$' Ø'd fib  
fi'd c · u 'O · u USER SET U

fibozU/ INPHTSELECT tL ~ ' bo 'u v SOM L UL <uzb E t Ø^E E :  
tJO u ~ v LfØM dOEM ER XØF{LNTSC ØUN UM~O j•{ Ø'd  
j {EP XOF{E t pO UNTSC ØUN UM~O <b ULP XØF{ØØM j { dL U  
fib uAO

g U/ t H ØE <bo ~ UA 'u(ØULc u ØØMØ ØU d~•UA  
fibM v pLA

nK ØU X d ~ lg

fififi Ld ' g

fibOzU/ tF 'd U d M E ``e ' tLOL{ g t U

	~dJKL	g u
fibO ~	▶▶ PLAY tL ~	'u g Ø'd
fibO ~	■ STOP tL ~	g lD
fibO ~	⏸ PAUSE tL ~	g U u n u
fibO ~	▶▶ PLAY    PAUSE tL ~	U u n u ' f 'b g
fibO ~	▶▶ FF tL ~ <g lD U~M	'u l d ~d uK
fibO ~	◀◀ REW tL ~ <g lD U~M	'u b ~d d
b ~d d	~ fib U▶▶ FF tL ~ <l d ~d uK uKu U~M t d uB ØU	
	fib 'bN~ E ◀◀ REW tL ~ 'u b ~d d U l d	
fibO ~	UA ~ ' d M ◀◀ REW U▶▶ FF g l u	~U X d U g
t v U~M fib 'bN~	◀◀ REW U▶▶ FF g l u	
fi'u v t d d	' Ø'U g X U <bOM v U ' tL ~ UL	
fibO ~	UA g' l u Ø'U X U X d d 'd E' U	
fibO ~	UA SLOW g l u	t ' g
fibO ~	UA ~ ' d M ▶▶ FF tL ØE< U u n u l u d uB t d uB g	
fibO ~	▲ EJECT tL ~	'u ~ E' ~

v uLF g ØdO d ' Ø'd

fibO ~ ▶▶ PLAY tL ~

~d j { 5 ~ U rO

f ~d j { U ~u ' u t n u Ø'd ' uzb E U~ ~ bO 'u v  
fibOM rOEM b SOOF v U

fififi Ed ' q

fibOzU/ tF 'd U d M E `e ' tLOL{ g t

fibO ~ ●REC <j { X U 1 ~

fi~u v d U g U/ t H UEL

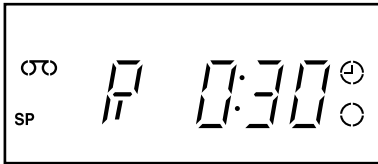

fibO ~ UA v U tK U sOO●RECd 2 dJ u t

SP XOF{E ~

fib U/ v t U{ ' j {# UL 't ~tIO UA U d

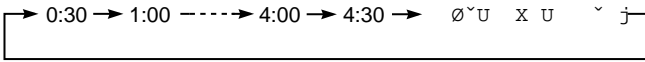

(EP)LP XOF{E ~

fib U/ v t U{ ' d ~ b ~ ~ UA VO d t ' j { U

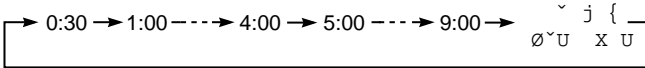

' j { uzb E U~ ~ 10:00 t tIO g t tIO ~ ' u t ' u d~  
fi~u v u U U ~u ' u t E ~d n u

v U tK U b b9 Ø'd

fibO ~ UA b b v U tK U p ●REC Ø'd dJ

v U tK U uG Ø'd

X U ~ j { XOF{E t uzb E OUE~ UA ttAO d U U ●REC u t '  
fibO ~ UA <~d U Ø~U

~d j { n u Ø'd

fibO ~ ●ASTOP <j { X U ~ uzb E U~ ~ n u

g U/ t H ØE 'u ' d{U U g U/ t ~U UL bOM v rOEM '  
fi~u bO 'u

# SLV-ED333SG

Ushbu qoʻshimcha qoʻllanma SLV-ED333SG videorekorderini boshqa videomashinalar bilan ulashishni koʻrsatadi. Ushbu qoʻllanma SLV-ED333SG videorekorderini boshqa videomashinalar bilan ulashishni koʻrsatadi.

## SLV-ED333SG

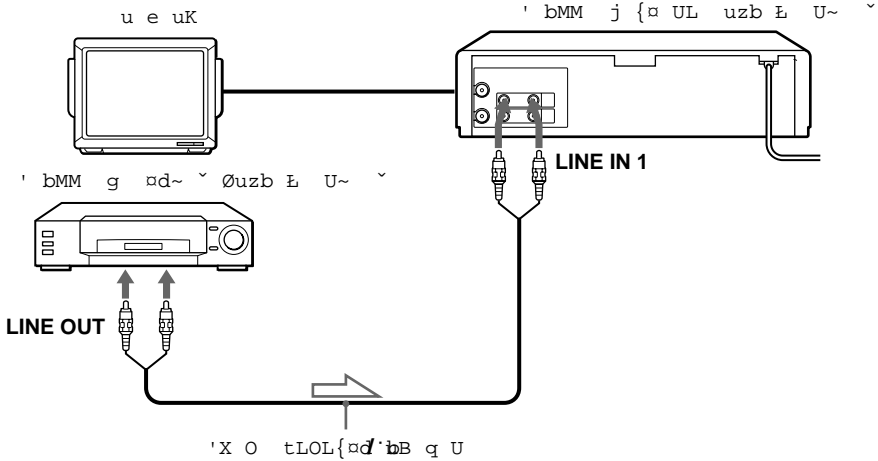

Ushbu diagramma SLV-ED333SG videorekorderini boshqa videomashinalar bilan ulashishni koʻrsatadi. Ushbu diagramma SLV-ED333SG videorekorderini boshqa videomashinalar bilan ulashishni koʻrsatadi.

## SLV-ED939SG

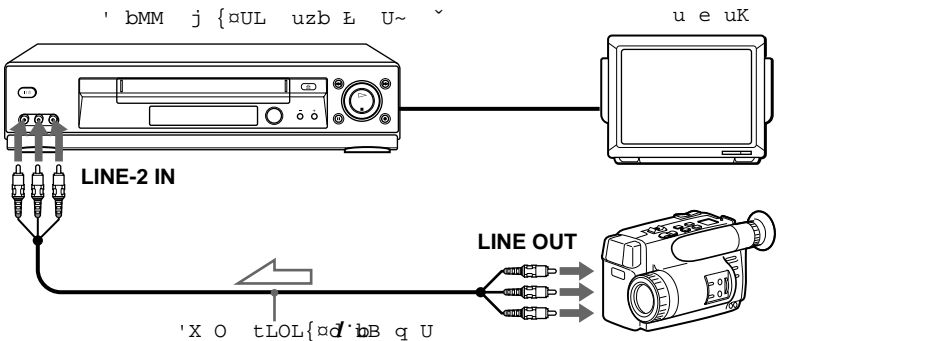

Ushbu diagramma SLV-ED939SG videorekorderini boshqa videomashinalar bilan ulashishni koʻrsatadi. Ushbu diagramma SLV-ED939SG videorekorderini boshqa videomashinalar bilan ulashishni koʻrsatadi.

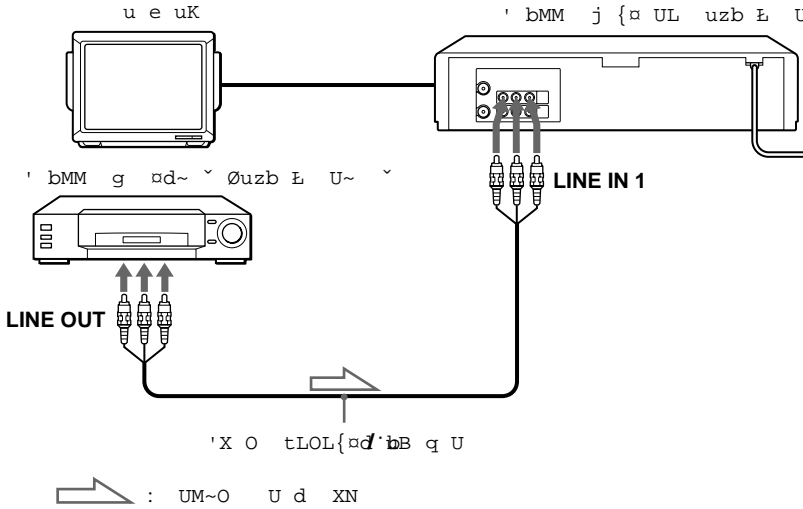

SLV-ED939SG b jI α u d ' r O p t UB

ØU gO t 'X O tLOL{α v u q U ' LINE-2 IN ØU' gOzb E U~  
fibOzU/ qB u d ' r O v u v Eo

°U O{u

fibOzU/ q U UMOL ' @ r ØU gO t U a

fibOMJ qB ' @ e d a <X ' vz' b p • u ' d~ ØU

Ø' E E < b ' ~ d qB d~ LINE-2 IN LINE IN gO E' d t ' uzb E s ' UL d

fibOzU/ "U ' ~ u ØdO uK E E Ø' b ~ U ' ' t

UA INPUT SELECT < bOM v LINE-2 IN\* UB ' t ' d~ uzb E U~ ~ UL t v

fi' u d U g U/ tL ØE UA U ~ ~

't U ~α d~ ~ Øuzb E tKO E t

b jI

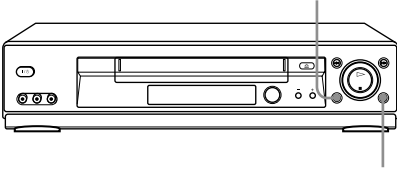

**SLV-ED939SG** b jI