

SONY®

3-066-544-11 (2)

Digital Still Camera

Operating Instructions _____

GB

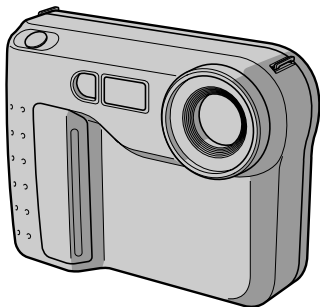

MVC-FD75

FD Mavica



English

Operating instructions

Before operating the unit, please read this manual thoroughly, and retain it for future reference.

As you read through this manual, buttons and settings on the camera are shown in capital letters.

e.g., Press FLASH.

WARNING

To prevent fire or shock hazard,
do not expose the unit to rain or moisture.

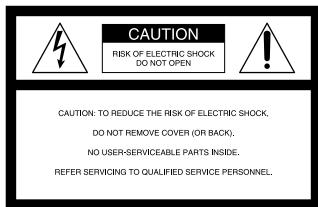

This symbol is intended to alert the user to the presence of uninsulated “dangerous voltage” within the product’s enclosure that may be of sufficient magnitude to constitute a risk of electric shock to persons.



This symbol is intended to alert the user to the presence of important operating and maintenance (servicing) instructions in the literature accompanying the appliance.

Owner’s Record

The model and serial numbers are located on the bottom. Record the serial number in the space provided below. Refer to these numbers whenever you call upon your Sony dealer regarding this product.

Model No. **MVC-FD75**

Serial No. _____

CAUTION

Never expose the battery pack to temperatures above 60°C (140°F), such as in a car parked in the sun or under direct sunlight.

TO PREVENT ELECTRIC SHOCK, DO NOT USE THIS POLARIZED AC PLUG WITH AN EXTENSION CORD, RECEPTACLE OR OTHER OUTLET UNLESS THE BLADES CAN BE FULLY INSERTED TO PREVENT BLADE EXPOSURE.

You are cautioned that any changes or modifications not expressly approved in this manual could void your authority to operate this equipment.

Note:

This equipment has been tested and found to comply with the limits for a Class B digital device, pursuant to Part 15 of the FCC Rules. These limits are designed to provide reasonable protection against harmful interference in a residential installation. This equipment generates, uses, and can radiate radio frequency energy and, if not installed and used in accordance with the instructions, may cause harmful interference to radio communications.

However, there is no guarantee that interference will not occur in a particular installation. If this equipment does cause harmful interference to radio or television reception, which can be determined by turning the equipment off and on, the user is encouraged to try to correct the interference by one or more of the following measures:

- Reorient or relocate the receiving antenna.
- Increase the separation between the equipment and receiver.
- Connect the equipment into an outlet on a circuit different from that to which the receiver is connected.
- Consult the dealer or an experienced radio/TV technician for help.

For the Customers in the United States and CANADA

DISPOSAL OF LITHIUM ION BATTERY.

LITHIUM ION BATTERY.

DISPOSE OF PROPERLY.

You can return you unwanted lithium ion batteries to your nearest Sony Service Center or Factory Service Center.

Note: In some areas the disposal of lithium ion batteries in household or business trash may be prohibited.

For the Sony Service Center nearest you call

1-800-222-SONY (United States only)



For the Factory Service Center nearest you call

416-499-SONY (Canada only)

Caution: Do not handle damaged or leaking lithium ion batteries.

NOTICE FOR THE CUSTOMERS IN THE UNITED KINGDOM

A moulded plug complying with BS 1363 is fitted to this equipment for your safety and convenience.

Should the fuse in the plug supplied need to be replaced, a 5 AMP fuse approved by ASTA or BSI to BS 1362, (i.e., marked with  or  mark) must be used.

If the plug supplied with this equipment has a detachable fuse cover, be sure to attach the fuse cover after you change the fuse. Never use the plug without the fuse cover. If you should lose the fuse cover, please contact your nearest Sony service station.

For the customers in Germany

Directive: EMC Directive 89/336/EEC.
92/31/EEC

This equipment complies with the EMC regulations when used under the following circumstances:

- Residential area
- Business district
- Light-industry district

(This equipment complies with the EMC standard regulations EN55022 Class B.)

ATTENTION

The electromagnetic fields at the specific frequencies may influence the picture of this camera.

Table of contents

Before using your camera	7
Parts identification	8

Basic operations

Preparation	11
1: Charging the battery pack	11
2: Installing the battery pack	12
3: Setting the date and time	13
Recording and playing back images	16
1: Recording images	16
2: Playing back images on the LCD screen	18
Battery life/No. of images that can be recorded/ played back	20
Viewing images using your computer	21

Advanced operations

Changing the mode settings	22
Using various functions for recording	31
Enjoying Picture Effect	31
Using the PROGRAM AE function	32

Additional information

Changing the lithium battery in the camera	33
Precautions	34
Troubleshooting	37
Self-diagnosis display	39
Specifications	40
Warning messages	41
Index	42

Be sure to read before using your camera

Trial recording

Before you record one-time events, you may want to make a trial recording to make sure that the camera is working correctly.

No compensation for contents of the recording

Contents of the recording cannot be compensated for if recording or playback is not made due to a malfunction of the camera, floppy disk, etc.

Lens and LCD screen/finder (on mounted models only)

- The LCD screen and the finder are manufactured using extremely high-precision technology so over 99.99% of the pixels are operational for effective use. However, there may be some tiny black points and/or bright points (white, red, blue or green in color) that constantly appear on the LCD screen and the finder. These points are normal in the manufacturing process and do not affect the recording in any way.
- Be careful when placing the camera near a window or outdoors. Exposing the LCD screen, the finder or the lens to direct sunlight for long periods may cause malfunctions.

Precaution on copyright

Floppy disk, television programs, films, video tapes, and other materials may be copyrighted. Unauthorized recording of such materials may be contrary to the provision of the copyright laws.

-
- MS DOS and Windows are either registered trademarks or trademarks of Microsoft Corporation in the United States and/or other countries.
 - Netscape Navigator is a trademark of Netscape Communications Corporation.
 - Macintosh and Mac OS are trademarks of Apple Computer, Inc.
 - All other product names mentioned herein may be the trademarks or registered trademarks of their respective companies.
- Furthermore, “TM” and “®” are not mentioned in each case in this manual.

Before using your camera

This digital still camera uses a floppy disk as media.

Use the following floppy disk type.

- Size: 3.5 inch
- Type: 2HD
- Capacity: 1.44 MB
- Format: MS-DOS format (512 bytes × 18 sector)

When using 3.5 inch, 2HD floppy disk other than described above, format it using the camera or your computer.

Do not shake or strike the unit

Malfunctions, inability to record images as well as inability to use floppy disks or image and memory data breakdown, damage or loss may occur.

Do not get the unit wet

When taking pictures outdoors in the rain or under similar conditions, be careful not to get the unit wet.

If moisture condensation occurs, refer to page 35 and follow instructions on how to remove it before using.

Back up recommendations

To avoid the potential risk of data loss always copy (back up) data to disk.

Supplied accessories

Digital still camera (1)	Battery charger (1)
Power cord (1 set)	NP-F330 battery pack (1)
Shoulder strap (1)	Lens cap (1)

Parts identification

See pages in () for more details.

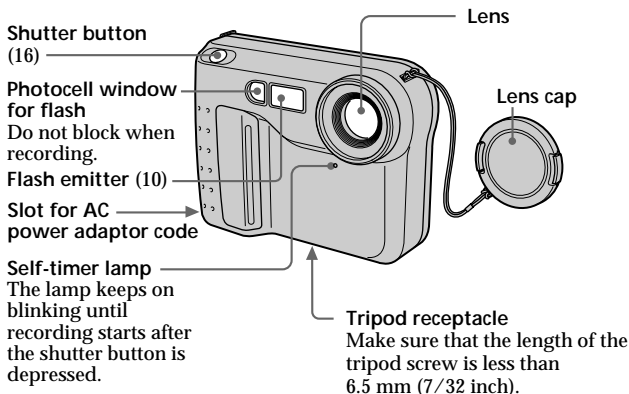

To insert the floppy disk

Insert the floppy disk until it clicks.

Before inserting, check that the write protect tab set to the recordable position.

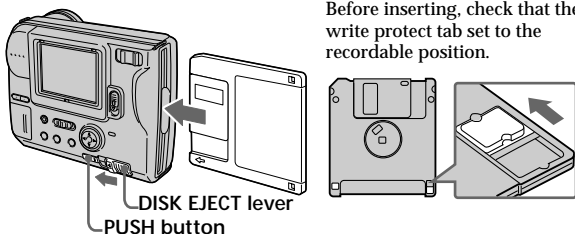

To remove the floppy disk

While pressing PUSH, slide DISK EJECT in the direction of the arrow.

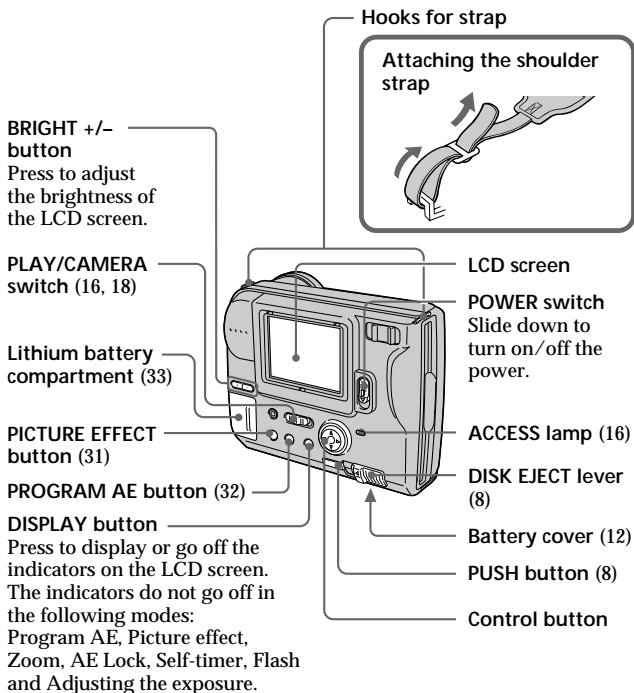

Control button

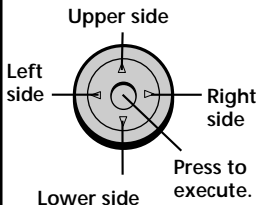

Function of the control button

You can execute the functions by pressing the upper, lower, left or right side of the control button. When an item is selected in the menu, the color of the item changes from blue to yellow. To enter your selection, press the center of the control button.

Zoom lever

“T” side: for telephoto (subject appears closer)

“W” side: for wide-angle (subject appears farther away)

Move the zoom lever to the “W” side until the focus is sharp.

You can shoot a subject that is at least about 100 cm (about 3 1/4 feet) away from the lens surface in the telephoto position, or about 1 cm (about 1/2 inch) away in the wide-angle position.

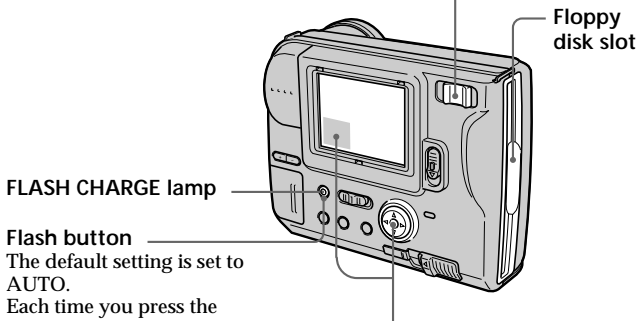



FLASH CHARGE lamp

Flash button

The default setting is set to AUTO.

Each time you press the button, the flash mode changes as follows:

- AUTO (no indication) →
- forced-flash  → no flash
-  → AUTO

In AUTO mode, the flash goes off automatically according to the brightness of the surroundings.

The subject must be 0.5 m to 2.5 m (1 5/8 feet to 8 1/3 feet) away.

When you record using the flash and conversion lens (optional), an eclipse may occur.

Self-timer

Select “” with the control button, then press it.

About 10 seconds after you press the shutter button, the subject is recorded.

Exposure

Select “+EV” or “-EV” on the LCD screen with the control button, then press it to select the desired value.

+EV: To raise the exposure value (brighten the picture)

-EV: To lower the exposure value (darken the picture)

Adjustable in a range of -1.5 EV to +1.5 EV in steps of 0.5 EV.

Preparation

1 Charging the battery pack

To charge the battery pack, use the battery charger. For details, refer to the instruction manual of the battery charger.

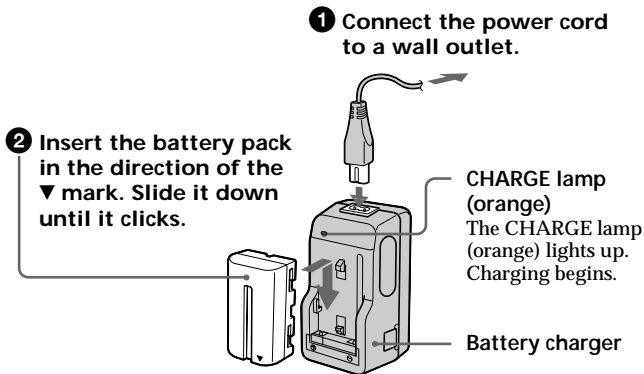

To remove the battery pack

Slide up the battery pack.

Charging time

Battery	Full charge*	Normal charge**
NP-F330 (Supplied)	210 min.	150 min.
NP-F550	240 min.	180 min.

Approximate minutes to charge an empty battery pack using the battery charger BC-V615. (Lower temperatures require a longer charging time.)

* Charging for about one hour after the CHARGE lamp goes out.

** Charging just until the CHARGE lamp goes out.

2 Installing the battery pack

1



(base)

Open the battery cover.

While sliding the battery cover in the direction of the arrow.

2

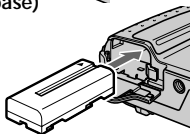

Install the battery pack.

Insert the battery pack with the ▼ mark facing toward the battery compartment.

3

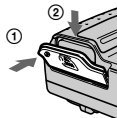

Close the cover.

Press the cover until it clicks.

To remove the battery pack

Open the battery cover. While sliding the battery release lever rightward, remove the battery pack.

Be careful not to drop the battery pack when removing.

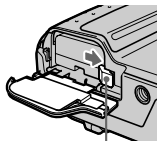

Battery release lever

Remaining battery time indication

This camera shows on the LCD panel how many minutes you can still keep on recording or playing back images*. Note, however, that the time might not be displayed correctly under some use conditions or in some environments.

* The time displayed during recording or during playback refers to the time for which the battery lasts if you simply keep the camera on or if you simply keep it displaying images without performing any operation.

Auto power-off function

During recording if you leave the camera inactive for about 3 minutes while the power is on, the camera turns off automatically to prevent wearing down the battery.

About the power source

This camera can be powered from the following two power sources:

- Sony InfoLithium battery* (L series), NP-F330 (supplied)/F550 (optional)
- AC power adaptor AC-VQ850D (optional)

When you use the camera for a long time, we recommend you to power the camera from a wall outlet with the AC power adaptor.

Using a car battery

Use Sony DC Adaptor/Charger (optional).

* What is "InfoLITHIUM?"

"InfoLITHIUM" is a lithium ion battery pack which can exchange information such as battery consumption with compatible video equipment. "InfoLITHIUM" L series battery packs have the  mark. "InfoLITHIUM" is a trademark of Sony Corporation.

3 Setting the date and time

When you use the camera first, set the date and time.

The date and time data are necessary for MS-DOS format recording. If they are not set, incorrect date and time are recorded, and CLOCK SET screen in step ③ appears whenever you turn on the camera in CAMERA mode.

- ① Slide POWER down to turn on the power.
- ② Select "CLOCK SET" in MENU with the control button, then press it.

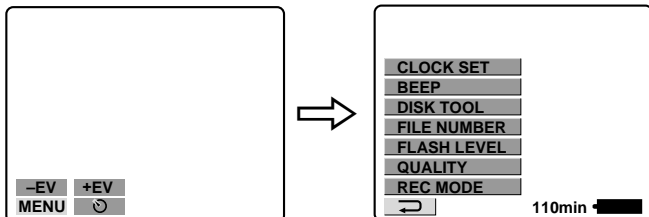

⇒ Preparation

- 3** Select the desired display of the date with the control button, then press it.

Y/M/D (year/month/day)

M/D/Y (month/day/year)

D/M/Y (day/month/year)

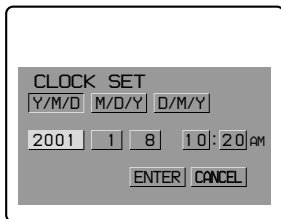

- 4** Select the date and time with the control button, then press it.

The item to be changed is indicated with ▲/▼. Select number by pressing the upper side or lower side of the control button, then press it to enter the number.

After entering the number, ▲/▼ moves to the next item.

When "D/M/Y" is selected, set the time on a 24-hour cycle.

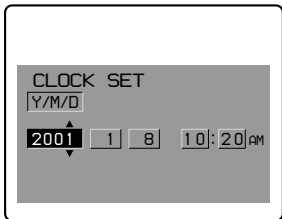

- 5** Select "ENTER" with the control button, then press it at the desired moment to begin clock movement.

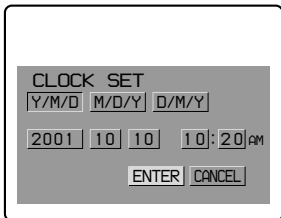

To cancel setting the date and time

Select "CANCEL" with the control button, then press it.

Note

If the "⚡" indicator appears on the LCD screen, replace the lithium battery according to the procedures on page 33.

Recording and playing back images

1 Recording images

To record the images, slide POWER down to turn on the power and insert the floppy disk until it clicks.

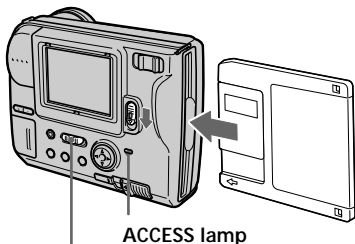

1 Set PLAY/CAMERA to CAMERA.

2 Press the shutter button halfway down.

The AE lock indicator ● (green) appears. AE (auto exposure), AWB (auto white balance) and AF (auto focus) are frozen.

3 Press the shutter button fully down.

The image is recorded on the disk.

The number of images you can record on a floppy disk

About 25 – 40 images with all default settings. (p. 24)

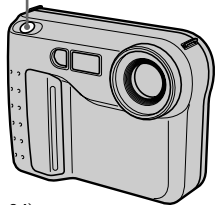

Note

When the image is recorded on the disk, the ACCESS lamp flashes. When the ACCESS lamp is flashing, never shake or strike the unit. As well do not turn the power off or remove the battery pack or floppy disk. Otherwise, the image data breakdown may occur and the floppy disk may become unusable.

The indicators during recording

The indicators on the LCD screen are not recorded.

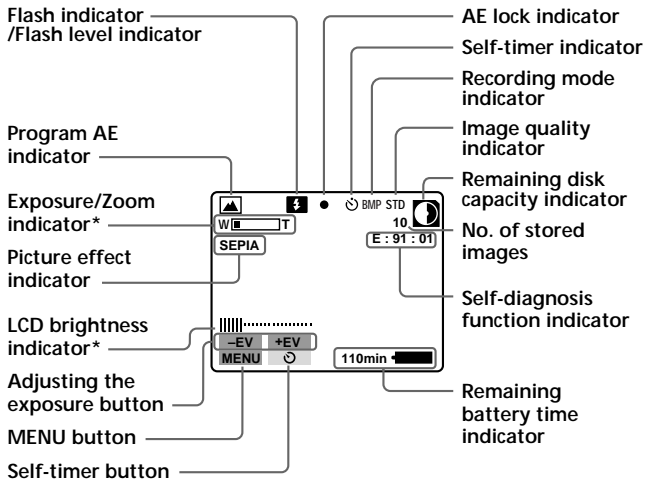

* Only displayed during operation.

Functions you can use for image recording

Adjusting the brightness of the LCD screen (p. 9)

Flash (p. 10)

Zoom (p. 10)

Self-timer (p. 10)

Adjusting the exposure (p. 10)

Picture effect (p. 31)

PROGRAM AE function (p. 32)

Selecting the recording mode
- REC MODE (p. 23)

Selecting the image quality
- QUALITY (p. 25)

Selecting the flash level
- FLASH LEVEL (p. 25)

Selecting the file numbering mode
- FILE NUMBER (p. 25)

2 Playing back images on the LCD screen

To watch the recorded images, slide POWER down to turn on the power and insert the floppy disk until clicks.

- 1** Set **PLAY/CAMERA** to **PLAY**.
The last recorded image appears on the LCD screen.

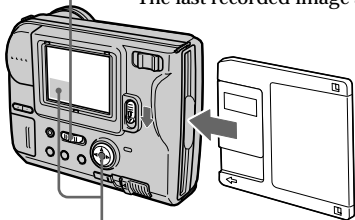

- 2** Select the recorded image with the control button.
Select the button on the LCD screen with the control button, then press it.

 : To display the preceding recorded image.

 : To display the next image.

INDEX : To display 6 recorded images at a time (INDEX screen)

In INDEX screen mode

 : To display the preceding 6 images.

 : To display the following 6 images.

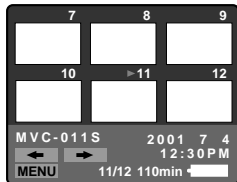

- To return to the normal playback screen (SINGLE screen), select an image with the control button, then press it.
- The number displayed at the upper right side of the image shows the recording order on the disk. It is different from the file name (p. 24).

The indicators during playback

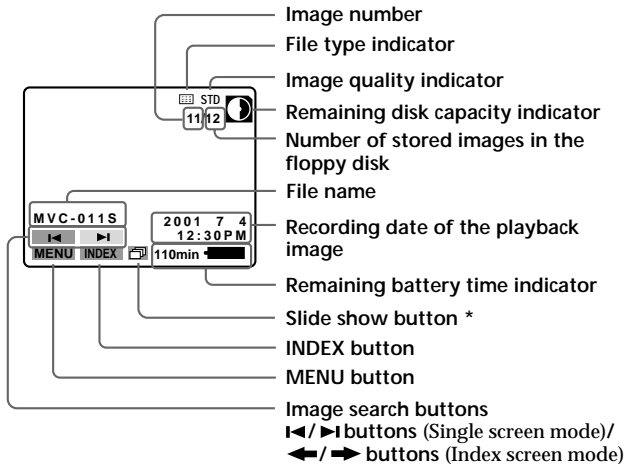

* Only displayed when the MULTI mode image is played back.

Functions you can use for playback of recorded images

Adjusting the brightness of the LCD screen (p. 9)

Playing back recorded images like an animated slide show (p. 23)

Protecting images – PROTECT (p. 26)

Copying recorded images to another floppy disk – COPY (p. 27)

Deleting images – DELETE (p. 28)

⇒ Recording and playing back images

Battery life/No. of images that can be recorded/played back

Battery		Battery life (min.)	No. of images (record/playback)
NP-F330 (Supplied)	Continuous recording		
	Unusing the flash ¹⁾	70 (60)	950 (850)
	Using the flash ²⁾	60 (50)	600 (500)
	Continuous playing ³⁾	110 (100)	1700 (1500)
NP-F550	Continuous recording		
	Unusing the flash ¹⁾	150 (130)	2200 (1950)
	Using the flash ²⁾	130 (110)	1300 (1100)
	Continuous playing ³⁾	250 (220)	3700 (3250)

Approximate battery life and No. of images that can be recorded/played back under the temperature of 25°C (77°F), in NORMAL recording mode and STANDARD quality mode. Numbers in parentheses indicate the time when you use a normally charged battery.

¹⁾ Recording at about 4 second intervals

²⁾ Recording at about 6 second intervals



³⁾ Playing back single image at about 4 second intervals

- Battery life and No. of images will be decreased if you use the camera in a cold environment or while you repeat turning the power on/off and zooming.
- The capacity of a floppy disk is limited. The above figures are a guide when continuously recording/playing back while replacing the floppy disks.

Viewing images using your computer

The image data recorded with this camera is compressed in JPEG format. This data can be viewed using your computer which has JPEG view ability application installed such as Microsoft Internet Explorer. For detailed procedures using image data with an application, refer to your computer instruction manual.

Example: your computer installed Windows 95/98/2000

- 1 Start up your computer and insert the floppy disk into the disk drive of your computer.**
- 2 Open "  My computer" and double click "  3.5 inch FD".**
- 3 Double-click the desired data file.**

Recommended OS/applications example

OS

Windows 3.1, Windows 95 or later, Windows NT 3.51 or later, etc.

applications

Microsoft Internet Explorer, Netscape Navigator etc.

Note

- For Macintosh, you can use the floppy disk recorded with this camera using the PC Exchange with Mac OS system 7.5 or higher. A viewing application for Macintosh is also necessary for viewing images.
- Opening non-compressed images recorded in BITMAP mode (p. 23, 24) requires an application program designed to view bitmap images.

Changing the mode settings

- 1 Select "MENU" with the control button, then press it.

The menu appears on the LCD screen.

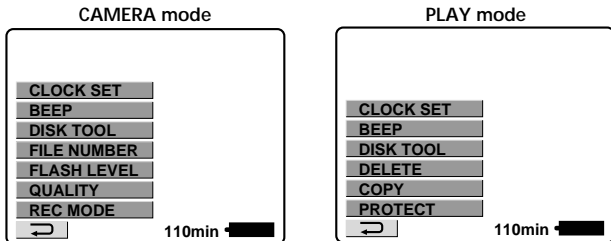

- 2 Select desired item with the control button, then press it.

When an item is selected, the color of the item changes from blue to yellow.

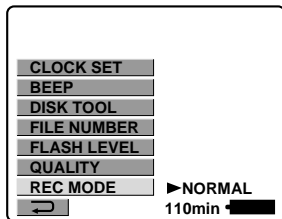

- 3 Change the setting with the control button, then press it.

When the setting is finished, the menu screen returns to the screen of step 1.

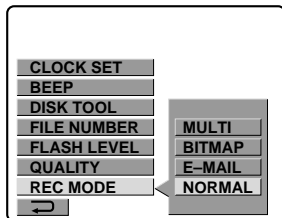



To cancel changing the mode settings

Press the left side of the control button. The screen returns to the menu screen. To cancel menu screen, select “

Setting the mode of each item

* is the default setting.

Items in CAMERA mode

REC MODE <NORMAL * /  E-MAIL /  BITMAP /
 MULTI >

- Normally select NORMAL. A JPEG file (640 × 480) is recorded.
- Select E-MAIL to record a 1/4-size (320 × 240) JPEG file besides a 640 × 480 JPEG file. E-mail files are suitable for e-mail transmission, etc. because they contain compressed data.
- Select BITMAP to record a non-compressed image besides a JPEG file. This is good for recording images in clearer detail.
- Select MULTI to record in the Multi-Image Continuous Recording mode. In this mode, Images are continuously recorded as 1 file each at a rate of about 1 every 0.25 seconds. In PLAY mode, if you select “

When playing back on another machine, only 1 image will be displayed.

⇒ Changing the mode settings

Recording mode	Recorded file	File name (ex.) MVC-	No. of images that can be recorded	
			STANDARD	FINE
NORMAL	JPEG (640 × 480) For index screen	001S.JPG 001S.411	25 - 40	15 - 20
E-MAIL	JPEG (640 × 480) JPEG (320 × 240) For index screen	001S.JPG 001E.JPG 001S.411	20 - 35	12 - 15
BITMAP	non-compress (640 × 480)	001S.BMP	1	1
	JPEG (640 x 480) For index screen	001S.JPG 001S.411		
MULTI	JPEG (960 × 720) For index screen	001M.JPG 001S.411	10 - 15	

Notes

- The file data for index screen is available only on this camera.
- If you attempt to record 55 images or above, "DISK FULL" appears on the LCD screen and you cannot record the image even when the remaining disk capacity indicator is not emptied.
- 1/4-size E-mail files are stored in another folder. The compression ratio is standard and does not depend on the image quality settings.
- A remaining capacity of about 1MB is needed when recording in BITMAP mode. After recording the BITMAP picture, "DISK FULL" appears on the LCD screen.
- In MULTI mode, the program AE, picture effect and focus are fixed to the selected mode and effect, respectively, and the flash is kept OFF. The focus may not be right if the zoom is operated. The compression ratio is standard and does not depend on the image quality settings.
- During playback of a series of images recorded in MULTI mode, the first image of the nine is displayed one-size smaller than the other normal-sized images.
- Be sure to play back images recorded in MULTI mode on MVC-FD71/FD73/FD75. Those images cannot be played back correctly on other models.
- When the remaining disk capacity indicator flashes, image data cannot be recorded.
- A MPEG file cannot be played back correctly on this camera.

QUALITY <STANDARD*/FINE>

- Select STANDARD as a standard image quality.
- Select FINE when giving priority to image quality.

FLASH LEVEL <⚡+ HIGH/⚡ NORMAL*/⚡- LOW>

- Set to make the flash level higher than normal.
- Normally select NORMAL.
- Set to make the flash level lower than normal.

FILE NUMBER <NORMAL*/SERIES>

- Select NORMAL to reset the numbering of files each time the floppy disk is changed.
- Select SERIES to put numbers to files in sequence even if the floppy disk is changed.

DEMO MODE <STANDBY/ON* or OFF>

Only when you use the AC power adaptor (optional), DEMO MODE appears in the menu.

- Select ON to make the demonstration appear. The demonstration will start about 10 minutes after the power is turned on if the camera has not been operated.
- Select OFF to deactivate the demonstration mode.

Note

To stop the demonstration, turn off the camera.

⇒ Changing the mode settings

Items in PLAY mode

PROTECT

Select this item to protect a displayed image(s) from being deleted by mistake.

To protect or unprotect an image file, select the desired option from the menu while the image is displayed on the LCD screen.

In SINGLE screen mode

<ON/OFF*>

- Select ON to protect displayed image.
- Select OFF to release protection of the image.

In INDEX screen mode

<ALL/SELECT>

- Select ALL to protect all the images on the floppy disk.
- Select SELECT to protect selected images.

① **Use the control button to display the red ► mark at the image you want to protect.**

The selected image number reverses color. To cancel selection, press the control button again. The image number returns to normal.

② **Select "ENTER" with the control button, then press it.**
◀ appears on the upper left side of the image.

To cancel protection of the images in INDEX screen mode, select the images you want to cancel protection in step ①, then press the control button.

The "◀" indicator at the upper left side of the image disappears.

When you have finished the cancelling, select "ENTER" with the control button, then press it.

To cancel protecting image, select "CANCEL" with the control button, then press it. The screen returns to the menu screen.

COPY

Select this item to copy a displayed image(s) to another floppy disk. To copy an image(s), select the desired copy option from the menu while the image(s) is displayed on the LCD screen.

In SINGLE screen mode

<OK/CANCEL>

- Select OK to copy displayed image.
- Select CANCEL to cancel copying image.

In INDEX screen mode

<ALL/SELECT>

- Select ALL to copy all the images on the floppy disk.
- Select SELECT to copy selected images.

① Use the control button to display the red ► mark at the image you want to copy.

The selected image number reverses color. To cancel selection, press the control button again. The image number display returns to normal.

② Select "ENTER" with the control button, then press it.

To cancel copying image, select "CANCEL" with the control button, then press it. The screen returns to the menu.

To copy to another floppy disk

1 In SINGLE screen mode, select "OK". Or In INDEX screen mode, select "ALL", then "OK" or select "SELECT", then carry out steps ① and ② above.

"CHANGE FLOPPY DISK" will be displayed.

2 Eject the floppy disk.

"INSERT FLOPPY DISK" will be displayed.

3 Insert another floppy disk until you hear it click.

"DISK ACCESS" will be displayed.

⇒ Changing the mode settings

4 Once copying is completed, the message “COMPLETE” is displayed.

To copy images to another floppy disk, select “CONTINUE” with the control button and repeat the operations in steps 2 through 4 above.

To discontinue copying, select “EXIT” with the control button.

Notes

- When you copy to the floppy disk which is a small remaining capacity, “DISK FULL” may appear on the LCD screen.
- To discontinue copying on a floppy disk halfway (in the middle of the above steps from 1 through 4), turn off the camera.

DELETE

Select this item to delete a displayed image(s)

To delete an image(s), select the desired delete option from the menu while the image(s) is displayed on the LCD screen.

In SINGLE screen mode

<OK/CANCEL>

- Select OK to delete displayed image.
- Select CANCEL to cancel deleting image.

In INDEX screen mode

<ALL/SELECT>

- Select ALL to delete all the images on the floppy disk.
- Select SELECT to delete selected images.

① Use the control button to display the red ► mark at the image you want to delete.

The selected image number reverses color. To cancel selection, press the control button again. The image number display returns to normal.

② Select “ENTER” with the control button, then press it.

To cancel deleting image, select “CANCEL” with the control button, then press it. The screen returns to the menu screen.

Notes

- Once you delete an image, you cannot restore it. Check the images to delete carefully before deleting them.
- Even when you select “ALL”, you cannot delete the protected image.
- When you select “SELECT”, you cannot select a protected image.

Items for both CAMERA and PLAY modes

DISK TOOL <FORMAT/DISK COPY>

- Select **FORMAT** to format the floppy disk loaded in the camera.
- Select **DISK COPY** to copy all data stored in a floppy disk to another.

To format a floppy disk

Select **"FORMAT"**, then **"OK"**.

"**FORMATTING**" will be displayed. Once formatting is completed, the message "**FORMATTING**" is disappeared.

To copy all data stored in a floppy disk to another

1 Select **"DISK COPY"**, then **"OK"**.

"**FILE ACCESS**" will be displayed.

2 When **"CHANGE FLOPPY DISK"** is displayed, eject the floppy disk.

3 When **"INSERT FLOPPY DISK"** is displayed, insert another disk.

"**DISK ACCESS**" will be displayed.

4 Once copying is completed, the message **"COMPLETE"** is displayed.

Notes

- To cancel copying in the middle of the above steps from 1 through 4, turn off the camera.
- Formatting erases all information on the floppy disk, and with copying disk, all information saved on the recipient floppy disk are erased to be replaced by newly written data including the protected image data. Check the contents of the disk before formatting and copying disk.
- Be sure that the battery is fully charged when formatting and copying a floppy disk. Formatting and copying takes about 1 minutes maximum.
- Be sure to use the formatted floppy disk to carry out **DISK COPY**.

⇒ Changing the mode settings

BEEP <ON*/OFF>

- Normally select ON.
- Select OFF to turn the beep sound off.

CLOCK SET

Select this item to set the date and time. See page 13.

Using various functions for recording

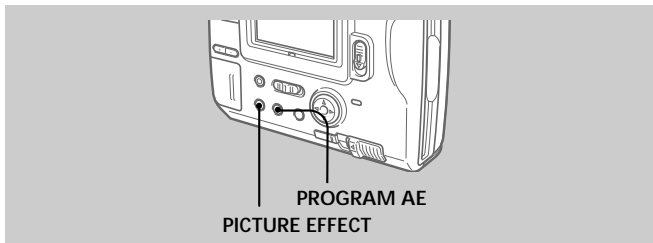

Enjoying Picture Effect

Press **PICTURE EFFECT** repeatedly to select the desired picture effect mode.

- NEG. ART:** The color and brightness of the picture is reversed.
- SEPIA:** The picture is sepia.
- B&W:** The picture is monochrome (black and white).
- SOLARIZE:** The light intensity is more clear, and the picture looks an illustration.

To cancel picture effect

Press **PICTURE EFFECT** repeatedly until the indicator on the LCD screen goes out. When you turn the power off or set **PLAY/CAMERA** to **PLAY**, the picture effect is automatically cancelled.

⇒ Using various functions for recording

Using the PROGRAM AE function

You can select one of six PROGRAM AE (Auto Exposure) modes to suit your shooting situation, referring to the following.

Press PROGRAM AE repeatedly to select the desired PROGRAM AE mode.

 **Soft Portrait mode**

Creates a soft background for subjects such as people or flowers.

 **Sports Lesson mode**

For recording fast-moving subjects such as in tennis or golf games.

 **Beach & Ski mode**

For people or faces in strong light or reflected light, such as at a beach in midsummer or on a ski slope.

 **Sunset & Moon mode**

For recording subjects in dark environments such as sunsets, fireworks, neon signs, or general night views.

 **Landscape mode**

For distant subjects such as mountains or when recording a subject behind an obstacle such as a window or screen.

 **Panfocus mode**

For recording close or distant subjects quickly and simply. Or, for recording with flash in a dark place where it is hard to bring the camera into focus.

To cancel PROGRAM AE

Press PROGRAM AE repeatedly until the indicator on the LCD screen goes out.

Notes on focus settings

- You cannot take close-ups in Sports Lesson and Beach & Ski modes.
- You can focus only on distance subjects in Sunset & Moon and Landscape modes.
- In Panfocus mode, the zoom position and focus are fixed.

Changing the lithium battery in the camera

When the lithium battery becomes weak or dead, the “” indicator flashes on the LCD screen. In this case, replace the battery with a Sony CR2025 or Duracell DL-2025 lithium battery. Use of any other battery may present a risk of fire or explosion.

When installing the lithium battery, keep the battery pack attached. Otherwise, you will need to reset the date and time retained by the lithium battery.

- 1 Slide the lid of the lithium battery compartment and open it.**
- 2 Push the lithium battery once and push it out from the holder.**
- 3 Install the lithium battery with the positive (+) side facing out.**
- 4 Close the lid.**

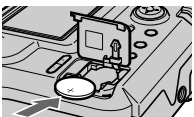

WARNING

The battery may explode if mistreated. Do not recharge, disassemble, or dispose of in fire.

CAUTION

Danger of explosion if battery is incorrectly replaced.

Replace only with the same type recommended by the manufacturer.

Discard used batteries according to the manufacturer's instructions.

Precautions

On cleaning

Cleaning the LCD screen

Wipe the screen surface with a LCD cleaning kit (optional) to remove fingerprints, dust, etc.

Cleaning the camera surface

Clean the camera surface with a soft cloth slightly moistened with water. Do not use any type of solvent such as alcohol or benzene as it may mar the finish of the casing.

Using the camera on a sandy beach or in a dusty place

Do not let sand get into the camera. Sand or dust may cause the unit to malfunction, and sometimes this malfunction cannot be repaired.

Concerning floppy disks

To protect data recorded on floppy disk, note the following:

- Avoid storing floppy disks near magnets or magnetic fields such as those of speakers and televisions, permanent erasure of disk data may result.
- Avoid storing floppy disks in areas subject to direct sunlight or sources of high temperature, such as a heating device. Floppy disk warping or damage may result, rendering the disk useless.
- Avoid contact with the disk's surface by opening the disk shutter plate. If the disk's surface becomes blemished, data may be rendered unreadable.
- Avoid getting liquids on the floppy disk.
- Be sure to use a floppy disk case to ensure protection of important data.
- Use a 2HD or a 2DD type disk head cleaner when cleaning the disk drive.
- Even when you use a 3.5 inch 2HD floppy disk, image data may not be recorded and/or displayed depending on the using environment. In this case, use other brand disks.

Operational temperature recommendations

This camera's operational temperature is between 0 °C to +40 °C (32 °F to +104 °F). Do not use this camera in extreme climates outside the operational temperature range.

Moisture condensation

If the camera is brought directly from a cold to a warm location, or is placed in a very damp room, moisture may condense inside or outside the camera. Should this occur, the camera will not operate properly. In this case, remove the floppy disk, turn off the camera, and wait about an hour for the moisture to evaporate.

To prevent moisture condensation

When bringing the camera from a cold place to a warm place, put the camera in a plastic bag and allow it to adapt to room conditions over period of time.

- ① Be sure to tightly seal the plastic bag containing the camera.
- ② Remove the bag when the air temperature inside it has reached the temperature surrounding it (about 1 hour).

Notes on lithium battery

- Keep the lithium battery out of the reach of children. Should the battery be swallowed, immediately consult a doctor.
- Wipe the battery with a dry cloth to assure a good contact.
- Do not hold the battery with metallic tweezers, otherwise a short-circuit may occur.
- Note that the lithium battery has a positive (+) and a negative (-) terminals. Be sure to install the lithium battery so that terminals on the battery match the terminals on the camera.

⇒Precautions

Using your camera abroad

You can use the battery charger BC-V615 within 100 V to 240 V AC, 50/60 Hz.

When charging the battery pack, use a commercially available AC plug adaptor [a], if necessary, depending on the design of the wall outlet [b].

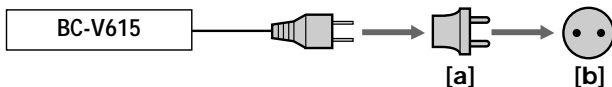

Troubleshooting

Should any problem persist after you have made those checks, consult your nearest Sony dealer. If "C: □□: □□" appears on the LCD screen, the self-diagnosis function has worked. See page 39.

Symptom	Cause and/or Solution
The camera does not work.	<ul style="list-style-type: none">• The camera does not operate when using a battery pack that is not an "InfoLITHIUM" battery pack. → Use an "InfoLITHIUM" battery pack. (p. 13)• The floppy disk is not installed properly. → Remove the disk and reinstall it. (p. 8)
You cannot record images.	<ul style="list-style-type: none">• PLAY/CAMERA is not set to CAMERA. → Set it to CAMERA. (p. 16)• The tab on the disk is set to the writing impossible position. → Set it to the writing possible position. (p. 8)
The picture is noisy.	<ul style="list-style-type: none">• The camera is placed near a TV or other equipment that uses strong magnets. → Place the camera away from the TV, etc.
The picture is too dark.	<ul style="list-style-type: none">• You are shooting a subject with the light source behind the subject or light is insufficient. → Adjust brightness of the image. (p. 10)• The LCD screen is adjusted too dark. → Adjust brightness. (p. 9)
Incorrect date and time are recorded.	<ul style="list-style-type: none">• The date and time are not set. → Set the date and time. (p. 13)
Vertical streaks appear when shooting a very bright subject.	<ul style="list-style-type: none">• The smear phenomenon. → The camera is not malfunctioning.
The battery life deteriorates too fast.	<ul style="list-style-type: none">• The ambient temperature is too low.• Charging of the battery pack is not enough. → Charge the battery pack fully.• The battery pack has served its time. → Replace the battery pack with a new one.

⇒ Troubleshooting

Symptom	Cause and/or Solution
Zoom does not work.	<ul style="list-style-type: none">• Panfocus mode in PROGRAM AE is working. → Cancel it. (p. 32)
You cannot play back the images.	<ul style="list-style-type: none">• PLAY/CAMERA is not set to PLAY. → Set it to PLAY. (p. 18)• The battery is dead. → Use a charged battery pack. (p. 11, 12)
You cannot delete an image.	<ul style="list-style-type: none">• The image is protected. → Cancel the protection of the image. (p. 26)
The power turns off automatically.	<ul style="list-style-type: none">• If you leave the camera inactive in CAMERA mode for about 3 minutes while the power is on, it turns off automatically to prevent wearing down the battery. → Turn the power on. (p. 12)
The image is out of focus.	<ul style="list-style-type: none">→ Select Panfocus mode in PROGRAM AE when shooting in a dark place which is difficult to focus on. (p. 32)

Self-diagnosis display

The camera has a self-diagnosis display. This function displays the camera condition with five-digits (a combination of a letter and figures) on the LCD screen. If this occurs check the following code chart. The five-digit display informs you of the camera current condition. The last two digits (indicated by □□) will differ depending on the state of the camera.

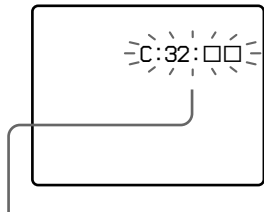

Self-diagnosis display

- C: □□: □□
You can reverse the camera malfunction yourself.
- E: □□: □□
Contact your Sony dealer or local authorized Sony service facility.

First three digits	Cause and/or Corrective Action
C:32:□□	<ul style="list-style-type: none">• Trouble is with the disk drive. → Turn the power off and on again.
C:13:□□	<ul style="list-style-type: none">• The unformatted disk is installed. → Format the disk. (p. 29)• The unusable disk with the camera is installed. → Change the disk. (p. 8)
E:91:□□	<ul style="list-style-type: none">• A camera malfunction which you can not reverse has occurred. → Contact your Sony dealer or local authorized Sony service facility and inform them of the five digits. (example: E:61:10)
E:61:□□	

Specifications

System

Image device	4.5 mm (1/4 type) CCD
Lens	f=4.2 – 42 mm (40 – 400 mm, when converted into a 35 mm still camera) F1.8 – 2.9
Exposure control	Automatic exposure
White balance	Automatic
Data compression	Standard JPEG
Memory	Floppy disk: 3.5 inch 2HD MS-DOS format (1.44 MB)
Flash	Recording distance limitations: 0.5 – 2.5 m (1 5/8 – 8 1/3ft.)

LCD screen

Screen size	6.2 cm (2.5 type)
LCD panel	TFT
Total dot number	84 260 dots



General

Application	Sony battery pack NP-F330/F550
Power requirements	7.2 V (battery pack)
Power consumption (During shooting)	3.0 W
Operation temperature	0 °C to +40 °C (32 °F to +104 °F)
Storage temperature	-20 °C to 60 °C (-4 °F to 140 °F)
Dimensions	Approx. 137.5 × 103 × 62 mm (5 2/5 × 4 1/8 × 2 1/2 in.) (w/h/d)
Mass	Approx. 590 g (20 4/5 oz.) (including battery pack NP-F330, lithium battery CR2025, floppy disk, shoulder strap and lens cap)
Supplied accessories	See page 7.

Design and specifications are subject to change without notice.

Warning messages

Various messages appear on the LCD screen. Check them with the following list.

Message	Meaning
DRIVE ERROR	Trouble is with the disk drive.
NO DISK	No disk has been inserted.
DISK ERROR	Trouble is with the disk. Or the floppy disk loaded is not MS-DOS formatted (512 bytes x 18 sectors).
DISK PROTECT	The tab on the disk is set to the writing impossible position.
DISK FULL	The disk is full.
NO FILE	No image has been recorded on the disk.
FILE ERROR	Trouble has occurred during playback.
FILE PROTECT	The image is protected.
	The battery is weak.
	The lithium battery is weak or is not installed.

Index

A

- Adjusting brightness
 - LCD screen 9
 - Image 10
- Adjusting the exposure 10
- AE (auto exposure) 16
- Auto power-off function 12

B, C

- Battery pack 11, 12
- Battery charger 11
- BEEP 30
- BITMAP 23
- Charging 11
- Cleaning 34
- CLOCK SET 30
- Control button 9
- COPY 27

D, E

- DELETE 28
- DEMO MODE 25
- DISK COPY 29
- DISK TOOL 29
- E-MAIL 23

F

- FILE NUMBER 25
- FLASH LEVEL 25
- Floppy disk 7, 34
- FORMAT 29
- Full charge 11

I

- Image quality 25
- INDEX screen 18
- Indicators on the LCD
 - screen 17, 19
- InfoLITHIUM battery pack 13

J, L

- JPEG 21, 23
- Lithium battery 35

M

- Menu 22
- Moisture condensation 35
- MULTI 23

N, P

- Normal charge 11
- PICTURE EFFECT 31
- Playing back 18
- PROGRAM AE 32
- PROTECT 26

R

- REC MODE 23
- Recording 16
- Remaining battery indicator
 - 17, 19

S, T

- Self-diagnosis display 39
- Self timer 10
- Setting the date and time 13
- Troubleshooting 37

U, V

- Using flash 10
- Using your camera abroad 36
- Viewing images using your
 - computer 21

W, Z

- Warning messages 41
- Zoom 10

Sony **on** line

<http://www.world.sony.com/>

Printed on recycled paper

Sony Corporation Printed in Japan



3 0 6 6 5 4 4 1 1