

Portable Memory Stick Player

Operating Instructions



NW-MS7

For the customers in the United States

Owner's Record

The model and serial numbers are located at the bottom of the player. Record the serial number in the space provided below. Refer to them whenever you call your Sony dealer regarding this product.

Model No. NW-MS7

Serial No. _____

INFORMATION:

This equipment has been tested and found to comply with the limits for a Class B digital device, pursuant to Part 15 of the FCC Rules. These limits are designed to provide reasonable protection against harmful interference in a residential installation. This equipment generates, uses, and can radiate radio frequency energy and, if not installed and used in accordance with the instructions, may cause harmful interference to radio communications.

However, there is no guarantee that interference will not occur in a particular installation. If this equipment does cause harmful interference to radio or television reception, which can be determined by turning the equipment off and on, the user is encouraged to try to correct the interference using one or more of the following measures:

- Reorient or relocate the receiving antenna.
- Increase the separation between the equipment and receiver.
- Connect the equipment into an outlet on a circuit different from that to which the receiver is connected.
- Consult the dealer or an experienced radio/TV technician for help.

You are cautioned that any changes or modifications not expressly approved in this manual could void your authority to operate this equipment.

If you have any questions about this product, you may call:

Sony Direct Response Center 1-(800)-222-7669

or write to:

Sony Direct Response Center 12451 Gateway Blvd.Fort Myers, FL 33913

Declaration of Conformity

Trade Name: SONY
Model No.: NW-MS7
Responsible Party: Sony Electronics Inc.
Address: 1 Sony Drive,
Park Ridge, NJ.07656 USA
Telephone No.: 201-930-6972

This device complies with Part 15 of the FCC Rules. Operation is subject to the following two conditions: (1) This device may not cause harmful interference, and (2) this device must accept any interference received, including interference that may cause undesired operation.

Notice for users

On the supplied software

- Copyright laws prohibit reproducing the software or the manual accompanying it in whole or in part, or renting the software without the permission of the copyright holder.
- In no event will SONY be liable for any financial damage, or loss of profits, including claims made by third parties, arising out of the use of the software supplied with this player.
- In the event a problem occurs with this software as a result of defective manufacturing, SONY will replace it.
However, SONY bears no other responsibility.
- The software provided with this player cannot be used with equipment other than that which is so designated.
- Please note that, due to continued efforts to improve quality, the software specifications may be changed without notice.
- Operation of this player with software other than that provided is not covered by the warranty.

Program©1999 Sony Corporation

Documentation©2000 Sony Corporation

NOTES:

- The recorded music is limited to private use only. Use of the music beyond this limit requires permission of the copyright holders.
- Sony is not responsible for music files that are not saved on your computer due to unsuccessful recording from CD or music downloading.
- A Backup/ Restore function requires the use of the Backup/ Restore service which Sony is currently developing. For authentication, this service requires the Internet. Details on the Backup/ Restore service will be available on the OpenMG Web site (<http://www.openmg.com/>).
- If your PC has optical output, the music played back on OpenMG Jukebox will not send digital data through that optical output.

Table of Contents

Overview	4
What you can do with	
“Memory Stick Walkman” ...	4
On copyright protection.....	5
On “MagicGate Memory Stick” ...	6
Other features	7
System requirements	7
About this manual	8
To use the Help files	8

Getting Started

Step 1: Unpacking	9
Step 2: Charging the battery	10
Step 3: Installing the OpenMG	
Jukebox software	11

Basic Operations

Transferring music data from the	
computer to Memory Stick	
Walkman	13
Listening to music with Memory	
Stick Walkman	16
On other operations	17
On the display	17

Advanced Operations (Memory Stick Walkman)

Playing in various modes	18
Emphasizing the bass sound (BASS) ..	18
Playing tracks repeatedly	
(REPEAT)	19
Protecting your hearing (AVLS) ..	20
Changing the display mode	20
Locking the controls (Hold)	21
Changing the settings of	
Memory Stick Walkman	21
To turn off the beep sound (BEEP) ...	21
To change the display backlight	
setting (LIGHT)	22
To adjust the LCD contrast	
(CONTRAST)	22
To format the “Memory Stick”	
(FORMAT)	23
To set the date and time	
(DATE & TIME)	24
Menu	25

Advanced Operations (OpenMG Jukebox)

Names and functions of the	
OpenMG Jukebox window	26
Menu Reference	28
OpenMG Jukebox	28
OpenMG CD Recorder	30
Transferring data from the	
“Memory Stick” to the computer	
(Check-In)	31
On the Windows Explorer	31
Uninstalling the OpenMG Jukebox	
.....	32

Other Information

Precautions	33
Notes on the rechargeable battery	
.....	34
Troubleshooting	35
To reset the player	35
What happened ?	35
Error messages	38
Specifications	40
Note on the supplied	
“Magic Gate Memory Stick” ...	40
Glossary	41
Restrictions on copyright protection	
by OpenMG	43
Looking at the controls	44
Index	46

Notes

- The illustrations in this manual may differ from the actual software.
- Explanations in this manual assume that you are familiar with basic operations of Windows 98. For how to use your computer and operating system, please refer to the respective manuals.

Overview

What you can do with "Memory Stick Walkman"

Memory Stick Walkman is a portable "Memory Stick" player. You can easily transfer digital sound data from your computer to Memory Stick Walkman.

Two copyright protection technologies* "OpenMG" and "MagicGate" allow you to enjoy digital music, while maintaining the copyrights of its holders.

The OpenMG compliant software "OpenMG Jukebox," which is supplied with your Memory Stick Walkman enables you to store digital music data on your computer's hard drive, transfer it to the Memory Stick Walkman and record it on "MagicGate Memory Stick."

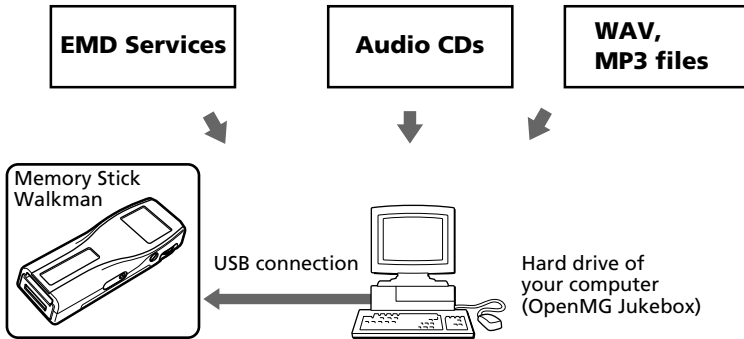

The supplied OpenMG Jukebox software allows you to import digital sound data to the hard drive of your computer as follows:

- downloads sound data provided by Electronic Music Distribution (EMD) services over digital networks such as the Internet
- records audio CDs onto the hard drive of your computer (the imported tracks are compressed and encoded in ATRAC3 format)
- encodes the existing MP3 and WAV format audio files to ATRAC3 and encrypts them in OpenMG format.

The OpenMG Jukebox encrypts sound data in OpenMG format and stores it on the hard drive of your computer to prevent unauthorized distribution.

* The copyright protection technology of Memory Stick Walkman conforms to the SDMI (Secure Digital Music Initiative) specifications.

On copyright protection

Memory Stick Walkman has some restrictions on recording and playback to protect copyrights. For details, see “Restrictions on the copyright protection by OpenMG” on page 43.

Transfer of sound data from your computer to Memory Stick Walkman – “Check-In/Out”

The supplied application software (OpenMG Jukebox) enables you to transfer the sound data stored on your computer’s hard drive to Memory Stick Walkman (Check-Out) and transfer it from Memory Stick Walkman to your computer (Check-In).



Check-In/Out has restrictions as follows:

- **You cannot Check-Out the same song more than three times (excluding certain audio contents).** However, if you transfer a Checked-Out song back to your computer (Check-In), you can then Check-Out the track again.
- **You cannot Check-In songs Checked-Out to Memory Stick Walkman to any computer other than the computer used for the Check-Out.**

For details, see “Glossary” on page 42.

Restrictions on sound data

Some sound data is distributed with restrictions on recording or playback of the data to maintain the copyrights of its holders.

Memory Stick Walkman employs copyright protection technology that enables you to record or play music within the limits determined by the copyright holders. For example, songs which have playback period restrictions can be played back only within the given period of time.

On “MagicGate Memory Stick”

What is a “Memory Stick”?

“Memory Stick” is a new compact, portable and versatile Integrated Circuit recording medium with a data capacity that exceeds a floppy disk. “Memory Stick” is specially designed for exchanging and sharing digital data among “Memory Stick” compatible products. Because it is removable, the “Memory Stick” can also be used for external data storage.

Types of “Memory Stick”

There are two types of “Memory Stick”:

- “MagicGate Memory Stick” that is equipped with “MagicGate” copyright protection technology.
- “Memory Stick” that is not equipped with “MagicGate” copyright protection technology. (See “Glossary” on page 41 for details.)

Use a “MagicGate Memory Stick” with this player.

A 64-MB “MagicGate Memory Stick” is supplied with this product.

When you purchase a spare “Memory Stick” for your Memory Stick Walkman, be sure to ask for a “MagicGate Memory Stick,” which is distinguished by the  logo.

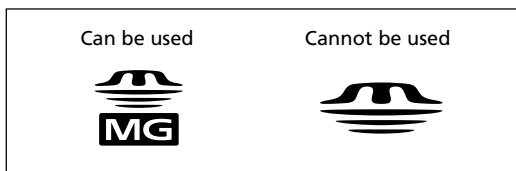

What is “MagicGate”?

“MagicGate” is a copyright protection technology for “MagicGate Memory Stick” and compliant products, such as Memory Stick Walkman. Authentication ensures that protected content is transferred only between compliant devices and “MagicGate Memory Stick,” and that protected content is recorded and transferred in an encrypted format to prevent unauthorized copying or playback.

Notes on use

To avoid damaging data, do not

- release the “Memory Stick” or unplug the AC power adaptor during reading or writing of data.
- use the “Memory Stick” in a location subject to static electricity or electric noise.

On formatting the “Memory Stick”

The “Memory Stick” is shipped with a FAT format as the standard format.

To format the “Memory Stick,” please use devices conformable with the “Memory Stick.” When using Memory Stick Walkman, please follow the instructions in “To format the Memory Stick” on page 23 to format the “Memory Stick.”

Note

If you format the “Memory Stick” using the computer, further operation with this player is not guaranteed.

Other features

- Compact size, light weight
- Anti-skip function: you can enjoy uninterrupted enjoyment of music during physical activities such as jogging or commuting.
- Recordable time: up to 60 min., 80 min., 120 min.* , on the supplied 64MB "MagicGate Memory Stick."
- Full-dot LCD screen: album titles and track names can be displayed for up to three lines.
- Jog lever: easy to operate, with a simple ejection mechanism for "MagicGate Memory Stick."
- High speed data transfer using the supplied USB cable.
- OpenMG Jukebox software enables you to record compact discs using the ATRAC3 format (high sound quality, high compression) to the hard drive.

* Differs according to the bit rate when recording. In this case, the figures for the recordable time are when recording on a 64MB "MagicGate Memory Stick" at 132kbps, 105kbps, and 66kbps.

System requirements

- IBM PC/AT or Compatible
CPU: MMX™ Pentium® 233MHz or higher
Hard disk drive space: 50MB or more
RAM: 64MB or higher
CD-ROM drive
Sound Board
USB port
- Operating System: Windows® 98/ Windows® 98 Second Edition (manufacturer installed)
The following environments are not supported.
 - Windows 95, Windows NT and Windows 2000
 - Upgraded from Windows 3.1/95 to Windows 98 (or Windows 98 Second Edition)
 - Dual boot with Windows 2000 and Windows 98 (or Windows 98 Second Edition)
- Display: High (16bit) Color or more (800 × 480 dot or more)
- Internet access: for Web registration and EMD services

"MagicGate Memory Stick," , "Memory Stick," , Memory Stick Walkman, and  WALKMAN are trademarks of Sony Corporation.

OpenMG and its logo are trademarks of Sony Corporation.

"MagicGate" and **MAGICGATE** are trademarks of Sony Corporation.

WALKMAN is a registered trademark of Sony Corporation.

IBM and PC/AT are registered trademarks of International Business Machines Corporation.

Microsoft and Windows are trademarks of Microsoft Corporation, registered in the U.S.A. and other countries.

Copyright ©1995 Microsoft Corporation. All Rights Reserved.

Portion Copyright ©1995 Microsoft Corporation

MMX and Pentium are registered trademarks of Intel Corporation.

All other trademarks and registered trademarks are trademarks or registered trademarks of their respective holders.

About this manual

This manual explains how to operate Memory Stick Walkman. For details on how to use the supplied software (OpenMG Jukebox), refer to the OpenMG Jukebox Help files.

To use the Help files

Displaying the Help files



The supplied software includes two types of Help files:

- OpenMG Jukebox Help: Help files on how to use the OpenMG Jukebox software.
- Memory Stick Walkman Help: Help files on how to use Memory Stick Walkman when connected to a computer.

You can display the Help files by either of the following ways:

- Click [Start]-[Programs]-[OpenMG Jukebox]-[OpenMG Jukebox Help] or [Memory Stick Walkman Help].
- Start the OpenMG Jukebox software, then click [Help]-[OpenMG Jukebox Help] or [Memory Stick Walkman Help].

Selecting a topic from the contents

- Double click  to display the items included in the title.
- Double click  to display the contents of the item.
- Click the underlined item to display reference page on the item.



Searching using a keyword

- 1** Select the [Index] tab from the Help dialog box.
The Keyword list appears.
- 2** Enter the keyword you want to apply, or scroll through the keyword list.
- 3** Select a topic, then click [Display].
Topics related to the keyword appear.

Step 1: Unpacking

Your Memory Stick Player comes with the following items.

- Memory Stick Player (1)

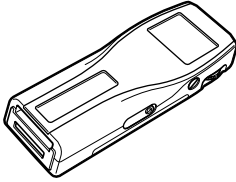

- Headphones extension cord (1)

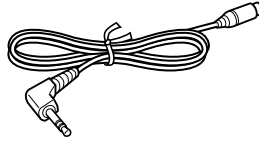

- "MagicGate Memory Stick" (1)

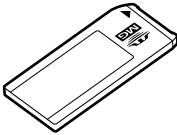

- USB cable (1)

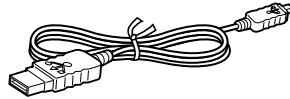

- DC/USB adaptor (1)



- AC power adaptor (1)
- Strap (for U.S.A. and Canadian model only) (1)
- Carrying pouch (except for U.S.A. and Canadian model) (1)
- CD-ROM (OpenMG Jukebox installation disc) (1)
- Operating Instructions (1)

- Headphones (1)

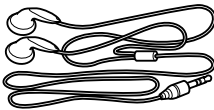

Note

Be sure to keep the CD-ROM and CD key in a secure place.

Step 2: Charging the battery

Please charge the battery before using the player.

To use power from an AC wall outlet, connect the AC power adaptor to Memory Stick Walkman as shown below.

You can use the player while charging the battery also.

- 1 Connect the DC/USB adaptor to Memory Stick Walkman.

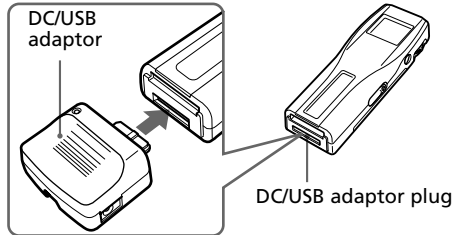

- 2 Connect the AC power adaptor to the DC IN 5.5V jack of the DC/USB adaptor and to the wall outlet.

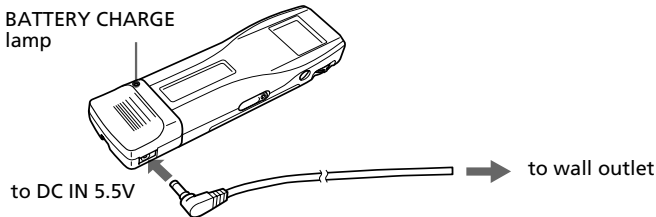

Charging begins and the BATTERY CHARGE lamp lights up. The BATTERY CHARGE lamp goes off when charging is complete. This takes about 3 hours maximum.

Note

Please charge the battery where temperature is 0°C to 35°C.

Battery duration

About 4 hours.

On the remaining battery indication

The battery icon in the display changes as shown below.

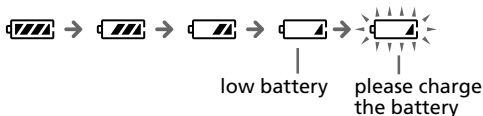

If "LOW BATT" is displayed in the display, you need to recharge the battery.

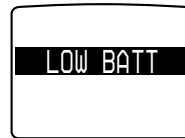

To release the DC/USB adaptor

Push the Release button gently to pull the DC/USB adaptor as shown below.

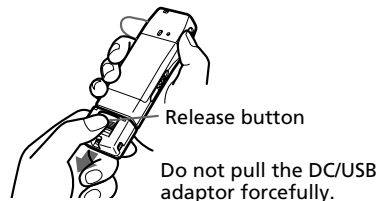

Step 3: Installing the OpenMG Jukebox software

This section describes how to install the OpenMG Jukebox software to your computer. Before installation, turn on your computer, and start Windows 98.

Note

Be sure to install the software before connecting with the supplied USB cable. Do not install the software while connecting the USB cable. Connect the USB cable only after you have restarted the computer after installation.

1 Insert the supplied CD-ROM into the CD-ROM drive of your computer.

For the customers in U.S.A. and Canada

The Setup program automatically starts and the following window appears. If the program does not start, double-click [Setup.exe].

For customers in other countries

- ① Find the folder labeled with the language you want to select in the CD-ROM.
For example, if you want to install the OpenMG Jukebox with help files in English, select the [English] folder.
- ② Open the desired folder, and double-click [Setup.exe] inside the folder.
The Setup program starts up and the following window appears.



2 Follow the instructions in the Installer window to complete the installation.

When the Input window for the CD key appears, input the CD key written on the CD-ROM case label .

When the installation is finished, the following dialog box appears in the display.



Click [Finish] to restart the computer.

Note

Do not delete, move or modify the installed folder.

continued

Step 3: Installing the OpenMG Jukebox software (continued)

About the “OpenMG Registration” icon on the desktop

When you restart the computer after installing the software, the “OpenMG(NW-MS7) Registration” icon will appear on the desktop. Make sure that you can connect to Internet, then double-click this icon to start customer registration for this product (Memory Stick Walkman) and for the EMD services.

For details on registration, refer to the supplied leaflet.

Notes on EMD (Electronic Music Distribution) services

To use OpenMG-enabled EMD services on the Internet, the following conditions are required.

- You need Internet access from your computer. (Sign up an Internet service provider.)
- You need to download several programs (e.g., EMD key installer).

To download these programs, double-click the “OpenMG Registration” icon, then follow the displayed instructions.

- You need to register yourself with the EMD service provider you are going to use. Consult the provider for details.

For current OpenMG Jukebox users

- 1** In order to update your OpenMG Jukebox software, your current software must be registered. If your software is not registered, please register your current software now. If you are a registered user, proceed to step 2.
- 2** Insert the CD-ROM supplied with your new product. This will automatically run. If the program does not start, double-click [Setup.exe]. Please follow the on-screen instructions to retain all existing music files and update your software.
- 3** After your update is completed, restart the computer. Then double-click the “OpenMG(NW-MS7) Registration” icon on your desktop and follow the instructions to register.

Notes

- If the OpenMG Jukebox icon is displayed on the task tray, right-click the icon to choose [Remove from the task tray], then proceed with the installation.
- Be sure to input the CD keys of the CD-ROM you are going to install. If an error message appears in the display, check if the CD keys are of the correct CD-ROM case label.

Transferring music data from the computer to Memory Stick Walkman

This section describes how to record the contents of a compact disc onto the hard drive of your computer, and then how to transfer it to Memory Stick Walkman (Check-Out).

You can also download by using EMD Services, or convert MP3 files and WAV format audio files. Please refer to the online help for more information.

1 Connect Memory Stick Walkman to your computer.

- ① Insert "MagicGate Memory Stick."

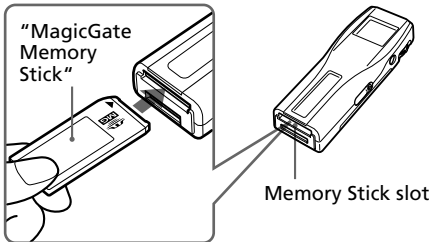

Notes

- When connecting Memory Stick Walkman to your computer, make sure the erasure prevention switch of the "Memory Stick" (page 33) is OFF .
- Do not start your computer while Memory Stick Walkman is connected.

- ② Connect the AC power adaptor.
Connect the supplied AC power adaptor to an AC wall outlet, then into the DC IN 5.5V jack on the right side of the DC/USB adaptor.

- ③ Connect Memory Stick Walkman to your computer.
Connect the small connector of the supplied USB cable into the USB jack on the left side of the DC/USB adaptor, then the large connector to the USB jack of your computer. "PC CONNECT" appears in the display.

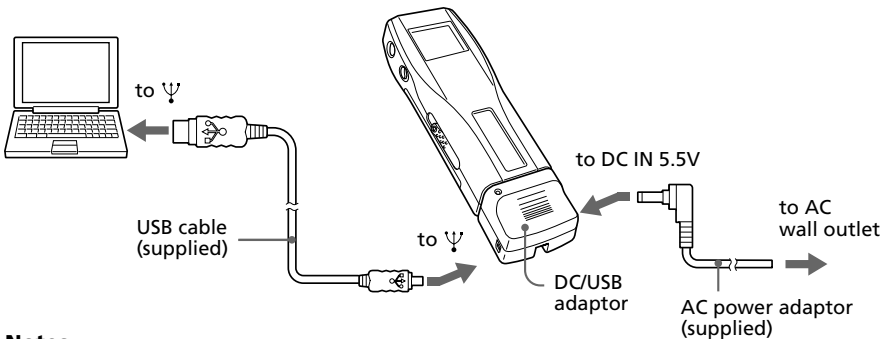

Notes

- Do not connect more than two USB devices to your computer. Normal operation will not be guaranteed.
- Use of this player with a USB hub or a USB extension cable is not guaranteed.
- A malfunction may occur depending on the USB devices connected at any one time.
- Be sure to connect the player to an AC wall outlet when connecting it to your computer.
- When connecting Memory Stick Walkman to your computer for the first time, the USB driver Installer window appears. Please follow the instructions in the Installer window.

Transferring music data from the computer to Memory Stick Walkman (continued)

2 Start the OpenMG Jukebox software.

Double click the OpenMG Jukebox icon on the desktop or click [Start]–[Programs]–[OpenMG Jukebox]–[OpenMG Jukebox]
The OpenMG Jukebox window appears.

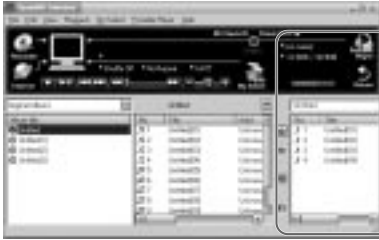

Portable Player window
(the music files inside the
“Memory Stick” appear)

If the Start-Up function is ON

The OpenMG Jukebox software automatically starts when Memory Stick Walkman is connected to your computer. (Please refer to the online help for more information.)

3 Start recording.

You can record music from a compact disc onto the hard drive of your computer, using the OpenMG CD Recorder software.

- ① Insert the compact disc you want to record into the CD-ROM drive of your computer. If the OpenMG CD Recorder automatically starts, go to ③.
- ② Click the [Recorder] button in the OpenMG Jukebox window.
The OpenMG CD Recorder window appears showing the contents of the compact disc.

If the message “Do you want to check your CD Drive to optimize for recording ?” appears in the display

This message appears when you use the OpenMG CD Recorder for the first time. We recommend you to choose [Yes]. You can optimize the CD drive later, too. Please refer to the online help for more information. (It may take maximum 20 minutes to optimize the CD drive.)

- ③ Click ●.



bit rate
● button

The recording begins. When recording is finished, the recorded music will appear in the OpenMG Jukebox window as a new album.

To stop the recording

Click **■**. The recording will be interrupted.
 Click **●** again to continue the recording.

To select only certain items

Click the check box of the contents you do not want to record to remove the check, then click **●**.

On the bit rate

You can choose the bit rate among 132kbps, 105kbps, 66kbps. If you choose a higher bit rate, recording will have better sound quality, however the recordable time will be shorter. If you choose a lower bit rate, you can record longer, however the sound will not be as good. See below for the recording time according to the bit rate when using the supplied 64MB "Memory Stick."

- 132kbps: maximum 60 min.
- 105kbps: maximum 80 min.
- 66kbps: maximum 120 min.

(The recording time differs according to the number of songs you are recording.)

To choose the bit rate, click [Control]-[Settings]. The Settings window appears. Click the Recording Setup tab and choose from the ATARC3 Bit rate list. Please refer to the online help for more information.

To name a new album or song

You can enter the name using the keyboard or bring the name from the Internet database.
 Please refer to the online help for more information.

4 Transfer the music file to the "Memory Stick" (Check-Out).

- ① Check that the Portable Player window (page 14) is displayed on the right side of the OpenMG Jukebox window.
- ② Click the album which contains the songs you want to Check-Out.
The contents of the album appear.
- ③ Click the music item you want to Check-Out.
Click the music item while pressing the Ctrl key to choose more than one music item.
- ④ Click the  button.
The desired music item appears in the Portable Player window as Check-Out candidate.



Click here

To cancel the song added as Check-Out candidate, click the respective song in the Portable Player window, then click the  button.

- ⑤ Click the START button.
The desired music item is Checked-Out to Memory Stick Walkman.
During Check-Out the STOP button flashes. When Check-Out is finished, the  indication changes to .

To quit Check-Out

Click the STOP button.

To Check-In

See page 31.

Listening to music with Memory Stick Walkman

Please charge the battery before use (see page 10).

Note

When using Memory Stick Walkman, be sure to disconnect it from the computer.

- 1 Insert a recorded "MagicGate Memory Stick" into Memory Stick Walkman.

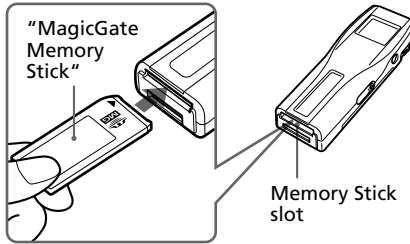

- 2 Connect the headphones.

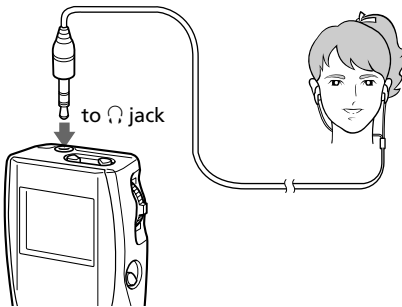

To use the headphones extension cord

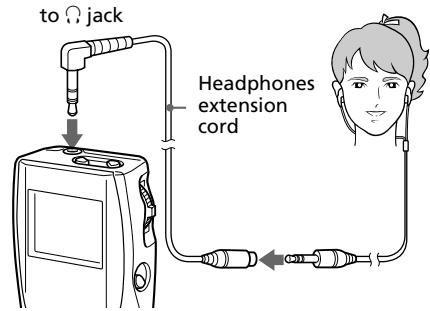

- 3 Start playback.

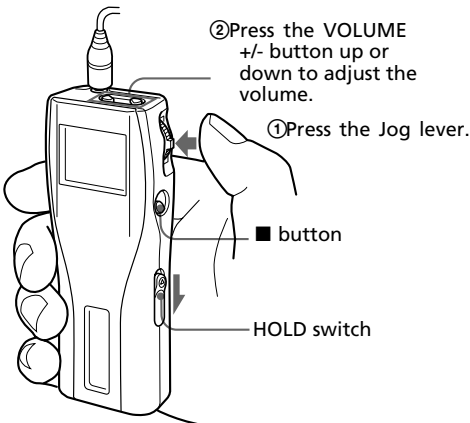

Playback stops automatically when the music reaches the end (only when REPEAT OFF is selected).

If playback does not start

The HOLD switch may be switched down. Please release it up (page 21).

To stop playback

Press the ■ button.

Tip

If you do not operate the player for 10 seconds while in stop mode, the display automatically turns off.

On other operations

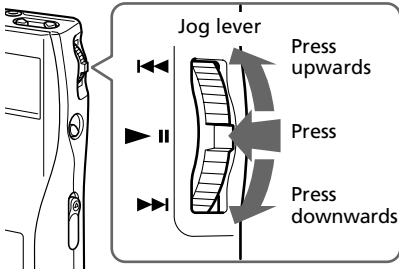

To	Operation of the Jog lever
Pause ¹⁾	Press while in playback mode.
Go to the beginning of the actual track	Press upwards once.
Go to previous tracks	Press upwards continuously.
Go to the beginning of the next track	Press downwards once.
Go to the beginning of the succeeding tracks	Press downwards continuously.
Go backward ²⁾	While playback, press up and hold still.
Go forward ²⁾	While playback, press down and hold still.

¹⁾ If you do not operate the player for 10 seconds while in pause mode, the player automatically switches to stop mode.

²⁾ To go backward or forward without listening to the sound, press upwards or downwards and hold while in pause mode.

To select by track name

While in stop mode, press the Jog lever up or down and hold it still. Three track names are displayed. Press the Jog lever upwards or downwards to select the track, then press the Jog lever to playback.



To take out the "Memory Stick"

Slide the EJECT lever in the direction of the arrow as shown below.

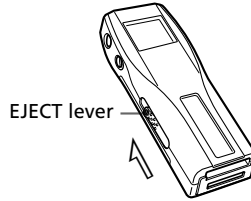

On the display

Press the DISPLAY button to change the display mode. See "Changing the display mode" (page 20) for more information.

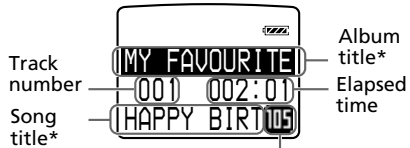

Bit rate

- songs recorded at 132kbps
- songs recorded at 105kbps
- songs recorded at 66kbps

* Song title and album title are displayed when information is recorded on the "Memory Stick."

Playing in various modes

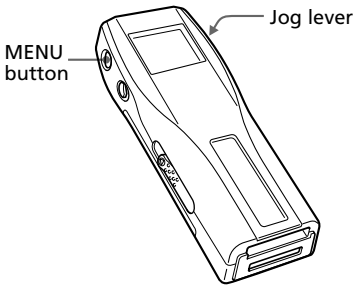

Emphasizing the bass sound (BASS)

Mega Bass function intensifies low frequency sound for richer quality audio reproduction.

Menu	Sound quality	Display indication
OFF	normal play	none
ON-1	Mega Bass (moderate effect)	BASS ▲
ON-2	Mega Bass (strong effect)	BASS ▲▲

- 3 Select ON-1 or ON-2 using the Jog lever.
- 4 Press the Jog lever.
- 5 Press the MENU button.
The display returns to normal.

Note

If the sound becomes distorted when emphasizing the bass, turn down the volume.

To exit from the Menu mode

Select [RETURN] in the menu or press the MENU button.

To cancel the MEGA BASS effect

Select OFF in step 3.

- 1 Press the MENU button.
The menu is displayed.
Check that "BASS" is selected.

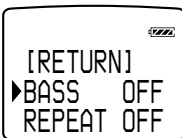

- 2 Press the Jog lever.

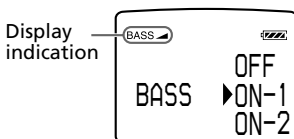

Playing tracks repeatedly (REPEAT)

You can play tracks repeatedly in three ways— all repeat, single repeat and shuffle repeat.

Menu	Playback mode	Display indication*
OFF	normal	none
ALL	all tracks repeatedly	↶
1	current track repeatedly	↶ 1
SHUF	all tracks repeatedly in random order	↶ SHUF

* The display indication appears after step 5.

1 Press the MENU button.
The menu is displayed.

2 Select "REPEAT" using the Jog lever.



3 Press the Jog lever.

4 Select "ALL," "1" or "SHUF" using the Jog lever.



5 Press the Jog lever.
The selected playback mode is displayed.

Display indication

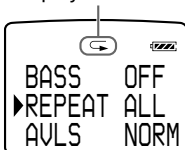

6 Press the MENU button.
The display returns to normal.

To exit from the Menu mode

Select [RETURN] in the menu or press the MENU button.

To cancel the REPEAT mode

Select OFF in step 4.

Note

If there is no "Memory Stick" inserted, "REPEAT ----" appears in the display, and repeat mode cannot be selected.

continued

**Playing in various modes
(continued)**

**Protecting your hearing
(AVLS)**

The AVLS (Automatic Volume Limiter System) function keeps down the maximum volume to protect your ears.

- 1 Press the MENU button.
The menu is displayed.
- 2 Select "AVLS" using the Jog lever.



- 3 Press the Jog lever.
- 4 Select "LIMIT" using the Jog lever.



- 5 Press the Jog lever.
The AVLS indication is displayed.

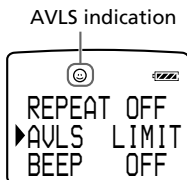

The volume is kept to a moderate level.

- 6 Press the MENU button.
The display returns to normal.

To exit from the Menu mode

Select [RETURN] in the menu or press the MENU button.

To cancel AVLS

Select NORM in step 4.

Changing the display mode

You can change the display mode and display the track number, the remaining time, etc. while in playback or stop mode.

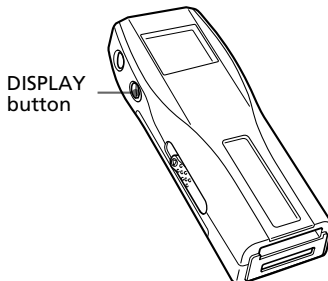

Press the DISPLAY button.
Each time you press the DISPLAY button, the display changes as shown below.

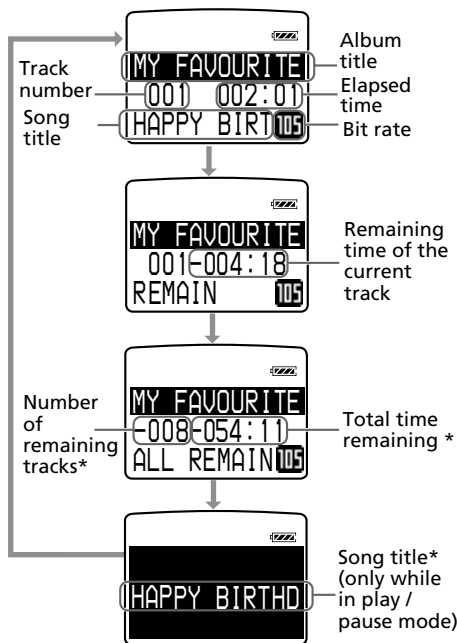

When playing in repeat mode, "----" appears instead of the number of remaining tracks and the total time remaining.

Locking the controls (Hold)

To prevent the controls from being accidentally operated when you carry the player, use this function.

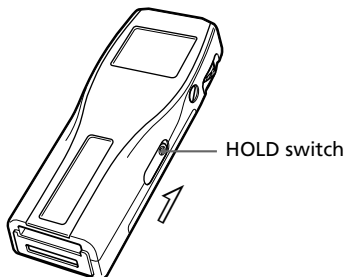

Slide the HOLD switch in the direction of the arrow.

No controls will be able to operate. (except the EJECT lever)

If you press buttons other than the Jog lever or the EJECT lever while the HOLD switch is ON, HOLD appears in the display.

The current time appears in the display when you press the Jog lever while the HOLD switch is ON. (See page 24)

To release the Hold function

Slide the HOLD switch in the opposite direction of the arrow.

Changing the settings of Memory Stick Walkman

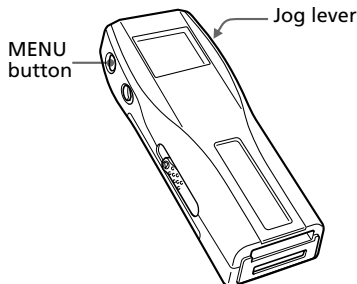

To turn off the beep sound (BEEP)

BEEP ON: a beep will sound to indicate that operation has been accepted.

BEEP OFF: no beep sound will be heard.

- 1 Press the MENU button.
The menu is displayed.
- 2 Select "BEEP" using the Jog lever.

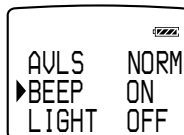

- 3 Press the Jog lever.
- 4 Select "OFF" using the Jog lever.

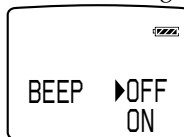

- 5 Press the Jog lever.
- 6 Press the MENU button.
The display returns to normal.

To exit from the Menu mode

Select [RETURN] in the menu or press the MENU button.

To cancel the Beep function

Select ON in step 4.

continued

Changing the settings of Memory Stick Walkman (continued)

To change the display backlight setting (LIGHT)

You can select from the following 3 settings.

Menu	Backlight mode
OFF	always off
ON	turns on during operation*
OPR	turns on for three seconds after each operation

* The battery life is shorter if ON is selected.

- 1 Press the MENU button.
The menu is displayed.
- 2 Select "LIGHT" using the Jog lever.

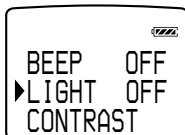

- 3 Press the Jog lever.
- 4 Select a backlight mode using the Jog lever.

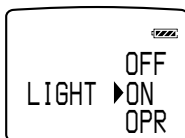

- 5 Press the Jog lever.
- 6 Press the MENU button.
The display returns to normal.

To exit from the Menu mode

Select [RETURN] in the menu or press the MENU button.

To adjust the LCD contrast (CONTRAST)

- 1 Press the MENU button.
The menu is displayed.
- 2 Select "CONTRAST" using the Jog lever.

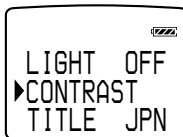

- 3 Press the Jog lever.
- 4 Select the contrast using the Jog lever.
You can adjust between -5 and +5



- 5 Press the Jog lever.
- 6 Press the MENU button.
The display returns to normal.

To exit from the Menu mode

Select [RETURN] in the menu or press the MENU button.

To format the “Memory Stick” (FORMAT)

If you need to format the “Memory Stick,” use this player.

If formatted, all data previously recorded on the “Memory Stick” will be erased. Be sure to check the data of the “Memory Stick” before formatting (data recorded using other devices will also be erased).

A commercially available “Memory Stick” is already formatted at the factory.

The supplied “Memory Stick” is also formatted.

Notes

- Be sure to connect the player to a power source with the AC power adaptor.
- You cannot use a “Memory Stick” that has been formatted using the computer.

1 Press the MENU button.
The menu is displayed.

2 Select “FORMAT” using the Jog lever.

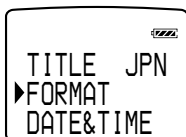

3 Press the Jog lever.

4 Select “YES” using the Jog lever.



5 Press the Jog lever.
“FORMAT OK?” appears in the display.



6 Press the Jog lever.
“FORMATTING” appears in the display, and the formatting of the “Memory Stick” begins.



When formatting is finished, “COMPLETE” appears in the display, and returns to the menu in step 2.

7 Press the MENU button.
The display returns to normal.

To exit from the Menu mode

Select [RETURN] in the menu or press the MENU button.

To cancel the formatting

Select “NO” in step 4 or press any button other than the Jog lever in step 5.

Notes

- You cannot format while playback or in pause (“FORMAT” will not be displayed).
- If the erasure prevention switch of the “Memory Stick” is ON, “LOCKED” appears in the display, and you cannot format the “Memory Stick.”
- Do not take out the “Memory Stick” or unplug the AC power adaptor when “FORMATTING” is displayed.

Changing the settings of Memory Stick Walkman (continued)

To set the date and time (DATE & TIME)

You can set the current date and time and display it. To play a music item with a playback period restriction (page 5), you need to set the date and time.

-
- 1 Press the MENU button.
The menu is displayed.

-
- 2 Select "DATE&TIME" using the Jog lever.

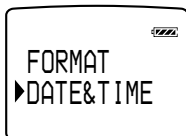

-
- 3 Press the Jog lever.
A cursor appears under the year.

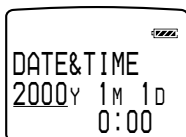

-
- 4 Set the year using the Jog lever.

-
- 5 Press the Jog lever.
The cursor moves to the month.

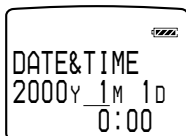

-
- 6 Do the same to set the month, day, hour and minutes, and then press the Jog lever.

-
- 7 Press the MENU button.
The display returns to normal.
-

To switch between 24 hour display and 12 hour display

Press the DISPLAY button during the setting.

To exit from the Menu mode

Select [RETURN] in the menu or press the MENU button.

To display the current time

You can display the current time by any of the following ways.

- Press the Jog lever while the display is OFF and the HOLD switch is ON.
→ The current time is displayed for 3 seconds while the Jog lever is being pressed.
- Press the Jog lever while the display is ON and the HOLD switch is ON.
→ The current time is displayed while the Jog lever is being pressed.
- Press the DISPLAY button for a while when the HOLD switch is OFF.
→ The current time is displayed while the DISPLAY button is being pressed.

Menu

Press the MENU button to display the menu.

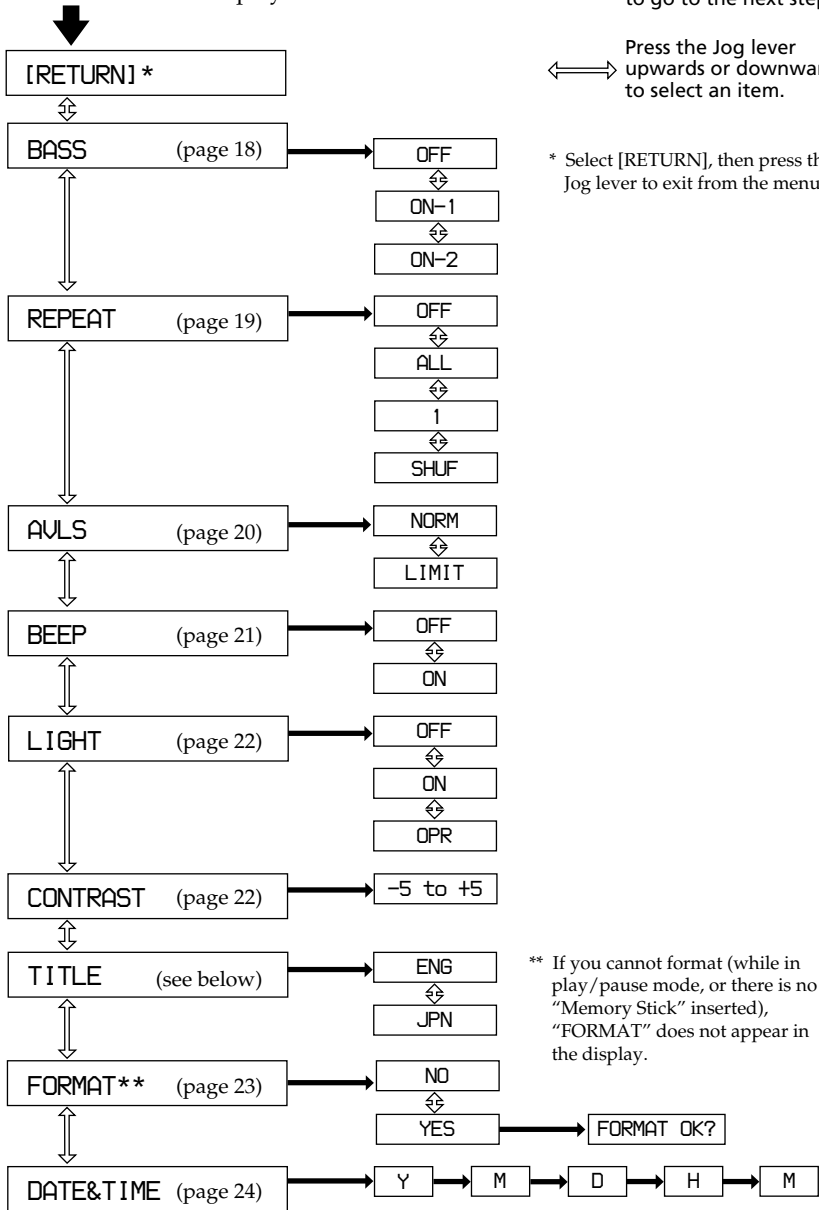

On the TITLE menu

You can choose between "ENG" (English) and "JPN" (Japanese). This function will be available in the future when the OpenMG Jukebox software is upgraded and you can use both English and Japanese for album and song titles.

Names and functions of the OpenMG Jukebox window

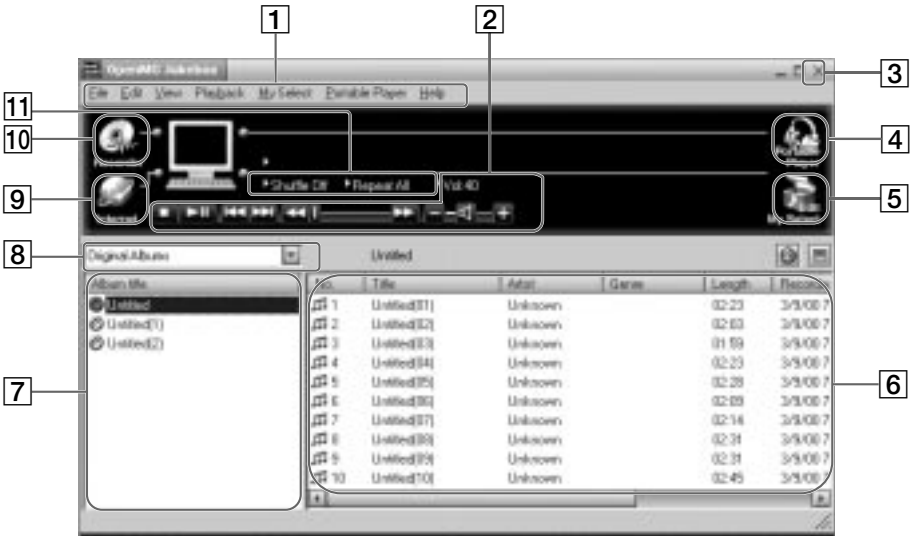

1 Menu bar: for details on each menu items, see page 28.

2 Operation buttons: you can play or adjust the volume, etc.

3 Close button: quits the OpenMG Jukebox software. (You can also quit by clicking [File]-[Quit])

4 Portable Player: opens the Portable Player window (page 27)

5 Edit My Select: opens the My Select window.

6 Song title list: displays the song titles listed in the selected album/Filter

7 Album title list: displays the album/Filter titles in the OpenMG Jukebox

8 Album view select box: You can select albums and songs that you want to view.
Original Albums= Displays an original album and the songs included in that album.

My Selections= Displays a My Select album and the songs included in that album.

Original & My Selections= Displays both albums and the songs included in those albums.

Various Search= Displays only the albums and songs which match a certain condition.

9 Internet: for using EMD services

10 Recorder: opens the OpenMG CD Recorder window

11 Playback mode buttons: you can set the shuffle mode, repeat mode, etc.

Portable Player window

When you connect Memory Stick Walkman to the computer, the Portable Player window appears in the display on the right side of the OpenMG Jukebox.

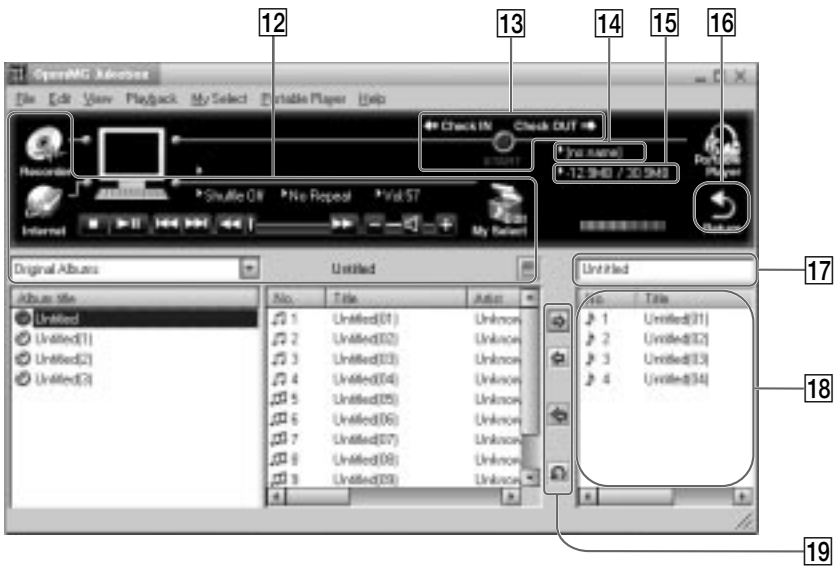

- 12 You can use these buttons to operate the OpenMG Jukebox software (see page 26 for more information).
- 13 CHECK IN/OUT START (STOP) button: starts or stops the Check-In/Out
- 14 Name of the connected portable player (such as Memory Stick Walkman)
- 15 Memory space on the "Memory Stick" or memory used for audio files, and total memory capacity*

- 16 RETURN button: closes the Portable Player window
 - 17 Album title of the "Memory Stick"
 - 18 Displays the song titles recorded on the "Memory Stick"
 - 19 Check-In/Out buttons (to start Check-In/Out, click the START button next)
- * When using a 64MB "Memory Stick," "61.8MB" appears in the display as the total memory capacity. This number is a result of subtracting program memory for the system operation of Memory Stick Walkman.

Menu Reference

OpenMG Jukebox

[File] menu

CD Recorder

Opens the OpenMG CD Recorder window.

Internet

Accesses the Web site for the EMD service supporting OpenMG or CD database.

File Import

MP3/ WAV: Starts up OpenMG File Importer.
Windows Media: Starts up OpenMG Internet File Importer (if available).

Settings

Displays the “Settings” window of the OpenMG Jukebox.

Exit

Exits the OpenMG Jukebox.

[Edit] menu

Delete

Deletes the currently selected album/song.

Divide

Divides the currently played song.

Combine

Combines the selected two songs.

Get CD Info

Automatically registers audio CD information such as the titles of an album or a song by accessing a CD database.

URL

Displays the web pages related to an album, registered in advance.

Rename

Changes the name of the currently selected album/song.

Enter Search Keyword

Displays the dialog box for entering search keywords for [Find by Artist], [Find by Song] or [Find by Genre] of the “Various Search” window.

Note

You cannot select this command when “Original Album” list, “My Select Album” list or search methods other than [Find by Artist], [Find by Song] or [Find by Genre] are displayed.

Properties

Shows information on the currently selected album/song.

[View] menu

Simple Mode

Switches the OpenMG Jukebox to “Simple Mode” window.

Cover Art

Displays images registered in the album as jacket illustrations.

Music Visualizer

Starts up Music Visualizer.
Shown only with Sony VAIO series computers in which Media Bar 3.0 or later is installed.

Operation Panel

Shows/hides the button/control information of the OpenMG Jukebox.

Status Bar

Shows/hides the Status Bar of the OpenMG Jukebox.

Original Album

Displays the “Original Album” list.

My Selection

Displays the “My Select Album” list.

Various Search

Displays the album list which matches a certain condition.

Refresh

Updates the various information shown on the OpenMG Jukebox to the latest data.

[Playback] menu

Play

Plays the currently selected album/song.

Pause

Pauses playback.

Stop

Stops playback.

Next

Locates the beginning of the next song in the currently played album.

Previous

Locates the beginning of the currently played song.

Repeat All

Repeats all songs in the currently played album.

Single Repeat

Repeats the currently played song.

No Repeat

Cancels repeat play and returns to normal playback.

Shuffle

Turns on and off the shuffle playback which plays the songs in an album in random order.

[My Select] menu

New

The “Edit My Select” window opens to create a new “My Select Album”.

Rename Album

Changes the name of a “My Select Album.”

Add Songs

Adds the currently selected song to the currently created “My Select” album.

Remove songs

Deletes the currently selected song from the “My Select Album” shown in the “Edit My Select” window.

Close

Closes the “Edit My Select” window.

[Portable Player] menu

Open

Opens the “Portable Player” window.

Execute

Checks in/out the “Check In/Check Out” candidates.

Stop

Stops “Check In/Check Out” before it is completed.

Undo

Cancels all the registration of the “Check In/Check Out” candidates.

Check Out

Registers the currently selected album/song as a “Check Out” candidate.

Check In

Registers the currently selected album/song as a “Check In” candidate.

Check In All

Registers all the songs in the portable player as “Check In” candidates.

Delete

Deletes the currently selected song from the portable player.

Rename

Changes the name of the currently connected portable player.

Select

When two or more portable players are connected to the computer, switches the player operated on the “Portable Player” window.

Initialize...

Initializes the memory of the connected portable player.

Note

Depending on the type of the portable player to connect to your computer, this function may not be utilized.

You cannot use this function with Memory Stick Walkman.

Close

Closes the “Portable Player” window.

[Help] menu

OpenMG Jukebox Help

Shows the help file for OpenMG Jukebox.

Memory Stick Walkman Help

Shows the help file for Memory Stick Walkman.

About OpenMG Jukebox

Shows the version, the CD key information, etc. of the OpenMG Jukebox.

If you have installed the OpenMG Jukebox with two or more CD-ROMs, the CD key of the CD you used first is displayed here.

Menu Reference (continued)

Menu items for the “Simple Mode”

Play

Plays the currently selected album/song.

Pause

Pauses playback.

Stop

Stops playback.

Next

Locates the beginning of the next song in the currently played album.

Previous

Locates the beginning of the currently played song.

Repeat All

Repeats all songs in the currently played album.

Single Repeat

Repeats the currently played song.

No Repeat

Cancels repeat play and returns to normal playback.

Shuffle

Turns on/off the shuffle play with which the songs in an album are played back in random order.

Select Album

Selects the album for playback. The [Select Album] dialog box appears. Choose the desired album and click [OK].

Always On Top

Shows the “Simple Mode” window always on top of other software.

Full Mode

Returns to the “Full Mode” window of the OpenMG Jukebox.

Skin

To select a Skin to use in the “Simple Mode.” The [Select Skin] dialog box appears. If more than one Skins are registered, choose the one you like and click [OK].

Exit

Exits the OpenMG Jukebox.

OpenMG CD Recorder

[Control] menu

Rec

Starts recording of an audio CD.

Stop

Stops recording of an audio CD.

Play

Plays an audio CD. You cannot play an audio CD while recording is performed.

Pause

Pauses playback of an audio CD.

Eject

Ejects an audio CD.

CD Info.

Automatically registers audio CD information such as the titles of an album or a song by accessing a CD database.

Internet

Accesses the Web site for the EMD service supporting OpenMG or CD database.

Select All Tracks

Selects all tracks in an audio CD for recording.

Clear All Tracks

Removes all the check marks for recording.

Settings

Displays the “Settings” window.

Launch OpenMG Jukebox

Starts up the OpenMG Jukebox.

Exit

Exits the OpenMG CD Recorder.

[Help] menu

Contents

Shows the help file for OpenMG Jukebox..



About OpenMG CD Recorder

Shows the version information of the OpenMG CD Recorder.

Transferring data from the “Memory Stick” to the computer (Check-In)

You can return the tracks recorded on a “Memory Stick” back to the hard drive of your computer (Check-In). You can return them only to the same computer from which the tracks have been Checked-Out.

1 Connect Memory Stick Walkman to your computer and start the OpenMG Jukebox software. The Portable Player window appears. See pages 13 and 14 for details.

2 Click the track you want to Check-In in the Portable Player window, then click the  button. Click the track while pressing the Ctrl key to choose more than one track. To Check-In all the tracks, click the  button.

3 Click the START button. The desired tracks are Checked-In. During Check-In, the STOP button flashes. When Check-In is finished, the song titles disappear from the Portable Player window.

To cancel Check-In

Click the STOP button.

On the Windows Explorer

When you connect Memory Stick Walkman to your computer with the supplied USB cable, you can display the data recorded on a “Memory Stick” as an external drive (for example, as the D drive) using the Windows Explorer.

Data is stored in a folder called Hifi Folder. Do not edit data that is stored in the Hifi Folder. You cannot playback data that has been copied or edited using the Windows Explorer.

On data that is not stored in the Hifi Folder

You can display data that has been recorded on other “Memory Stick” compatible devices (JPEG data, MPEG data, etc.). However, if you transfer or copy data that has been displayed on the Windows Explorer, further normal operation will not be guaranteed. To edit data on your computer, do not use Memory Stick Walkman. Please use the Memory Stick slot or a Memory Stick adaptor.

For information on how to handle data that is not stored in the Hifi Folder, please refer to the instruction manual that comes with the equipment with which the recording has been done.

Note

Even if you display data on the Windows Explorer without using the OpenMG Jukebox, the use of the AC power adaptor is recommended. (If you use only the battery, data may be broken when the battery is exhausted)

Note on formatting

When formatting the “Memory Stick,” do not use the format function on the Windows Explorer. “FORMAT ERROR” (page 38) is displayed and you cannot playback using Memory Stick Walkman. Please follow the instructions on how to format a “Memory Stick” on page 23.

Uninstalling the OpenMG Jukebox

Follow the instructions below on how to uninstall the OpenMG Jukebox.

-
- 1** Click [Start]–[Settings]–[Control Panel] to display the Control Panel.

 - 2** Double-click [Add/Remove programs].
The Add/Remove programs Property window appears.

 - 3** Click “OpenMG Jukebox” from the list.

 - 4** Click Add/Remove.
The OpenMG Jukebox software is uninstalled.
-

Note

After installation, the compact disc may not start playing automatically when inserted into the CD-ROM drive. In this case, refer to the instruction manual or online help of the player software you are using to set to start automatically.

Precautions

On safety

Do not put any foreign objects in the DC IN 5.5V jack.

On power sources

- Use the AC power adaptor supplied with this player. Do not use any other AC power adaptor since this may cause the player to malfunction.



- The player is not disconnected from the AC power source (mains) as long as it is connected to the wall outlet, even if the player itself has been turned off.
- If you are not going to use this player for a long time, be sure to disconnect the power supply. To remove the AC power adaptor from the wall outlet, grasp the adaptor plug itself; never pull the cord.

On installation

- Never use the player where it will be subjected to extremes of light, temperature, moisture or vibration.
- Never wrap the player in anything when it is being used with the AC power adaptor. Heat build-up in the player may cause malfunction or damage.

On heat build-up

Heat may build up in the player while charging if it is used for an extended period of time.

On handling the "Memory Stick"

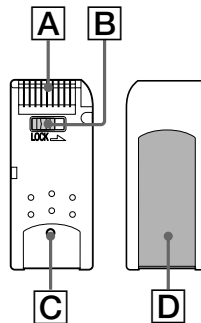

- When the "Memory Stick" erasure prevention switch is set to "LOCK," data cannot be recorded, erased or edited. (B)
- The tactile protrusion on the rear surface of "MagicGate Memory Stick" distinguishes it from a general "Memory Stick." (C)
- Do not attach any other material than the supplied label on the label space. (D)
- Attach the label so that it does not stick out from the proper attachment location.
- Do not touch the "Memory Stick" connector with your finger or metallic objects. (A)
- Do not bend, drop or apply strong shock to the "Memory Stick."
- Do not disassemble or modify the "Memory Stick."
- Do not allow the "Memory Stick" to get wet.
- Do not use or store the "Memory Stick" in a location that is subject to:
 - Extremely high temperature, such as in a car parked in the sun
 - Direct sunlight
 - High humidity or places with corrosive substances
- To prolong the life of the "Memory Stick," use the supplied storage case.

Precautions (continued)

On the headphones

Road Safety

Do not use headphones while driving, cycling, or operating any motorized vehicle. It may create a traffic hazard and is illegal in many areas. It can also be potentially dangerous to play your player at high volume while walking, especially at pedestrian crossings. You should exercise extreme caution or discontinue use in potentially hazardous situations.

Preventing hearing damage

Avoid using headphones at high volume. Hearing experts advise against continuous, loud and extended play. If you experience a ringing in your ears, reduce the volume or discontinue use.

Caring for others

Keep the volume at a moderate level. This will allow you to hear outside sounds and to be considerate of the people around you.

On cleaning

- Clean the player casing with a soft cloth slightly moistened with water or a mild detergent solution. Do not use any type of abrasive pad, scouring powder or solvent such as alcohol or benzene as it may mar the finish of the casing.
- Clean the headphones plug and extension cord plug periodically.

If you have any questions or problems concerning your Memory Stick Walkman, please consult your nearest Sony dealer. (If trouble occurred when the "Memory Stick" was in the player, we recommend that the "Memory Stick" be left in the player when you consult your Sony dealer so that the cause of trouble may be better understood.)

Notes on the rechargeable battery

- Be sure to use the supplied AC power adaptor for charging.
- The charging time may vary depending on the battery condition.
- When a rechargeable battery is charged for the first time or charged after a long period of disuse, battery life may be shorter than usual. Repeat discharging and recharging a few times. The battery life should return to normal.
- When the battery life of a fully charged rechargeable battery becomes about half the normal life, you may need to replace the battery. Please contact your nearest Sony dealer.
- This player has a built-in lithium ion battery. When you dispose of the player, be sure to dispose of it properly.

For the customers in the U.S.A. and Canada

DISPOSAL OF LITHIUM ION BATTERY.

LITHIUM ION BATTERY.
DISPOSE OF PROPERLY.

This unit has a built-in lithium ion battery.

Do not attempt to remove the battery from the unit.

Please consult your nearest Sony Service Center or Factory Service Center to have the battery removed from the unit and disposed of properly.

Note: In some areas the disposal of lithium ion batteries in household or business trash may be prohibited.

For the Sony Service Center nearest you call: 1-800-222-SONY (United States only)

For the Sony Factory Service Center nearest you call: 416-499-SONY (Canada only)

Caution: Do not handle damaged or leaking lithium ion batteries.

Voor de Klanten in Nederland



Bij dit product zijn batterijen geleverd. Wanneer deze leeg zijn, moet u ze niet weggooien maar inleveren als KCA.

Troubleshooting

If you experience any of the following difficulties while using Memory Stick Walkman, use this troubleshooting guide to help you remedy the problem. Should any problem persist, consult your nearest Sony dealer. For trouble concerning operations while connecting with your computer, please refer to the supplied software's online help "Troubleshooting" contents, too.

To reset the player

If Memory Stick Walkman does not operate normally even after checking the troubleshooting guide below, press the RESET button on the rear of Memory Stick Walkman with a thin object and hold it there for more than one second.

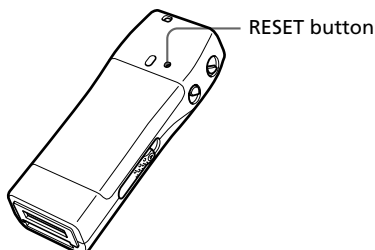

What happened ?

On playback

Symptom	Cause/Remedy
There is no sound.	→ Adjust the volume. (page 16)
The volume does not increase.	→ Set the AVLS function to "NORM." (page 20)
Sound is distorted.	→ Record with a higher bps value. (page 15)
There is no sound from the right channel of the headphones.	→ Make sure that the headphones plug is connected securely.
The same track is repeated while in Shuffle mode.	→ If you stop playback, the player reshuffles the tracks and the track played before stopping may play again as the first selected track.
Playback has stopped suddenly.	→ The battery is exhausted. You need to charge it. (page 10) → Release and reinsert the "Memory Stick" a few times to clean the terminals.
Cannot playback audio data with date limits.	→ You must set the date in the menu. (page 24) → The date has expired. → The erasure prevention switch is on LOCK.
The sound is not normal after I reset the player.	→ You must press the RESET button longer. Press the RESET button with a thin object for more than one second. (page 35)

On the display window

Symptom	Cause/Remedy
The backlight is off.	→ Set the LIGHT setting to OPR (three seconds after each operation) or ON (during operation) in the menu. (page 22)
The LCD is light/dark.	→ Set the CONTRAST setting in the menu. (page 22)
"□" appears instead of the album title.	→ Use the OpenMG Jukebox to rename the title with characters which can be displayed on the player.

Troubleshooting (continued)

On charging

Symptom	Cause/Remedy
The battery does not last even when recharged.	<ul style="list-style-type: none">→ If you use the player where the temperature is below 0°C (32°F), the battery does not function.→ You need to replace the battery. Please contact your nearest Sony dealer.
The battery is quickly exhausted.	→ When you connect the player to your computer, use the supplied AC power adaptor, otherwise the battery is quickly exhausted. (page 13)
Charging stops just after connecting the supplied AC power adaptor.	→ The battery is full. (If the charging stops even when the battery is low, this may be due to a problem with the battery life. Please contact your nearest Sony dealer.)

On the connection with the computer

Symptom	Cause/Remedy
“PC CONNECT” does not appear in the display window when connecting to the computer with the supplied USB cable.	<ul style="list-style-type: none">→ Please wait for the authentication of the OpenMG Jukebox (page 41) to be finished.→ If another software is active on your computer, wait for a while, then reconnect the USB cable. If the problem persists, disconnect the USB cable, restart your computer, then connect the USB cable to your computer again.→ Make sure the USB cable is correctly connected.
The player is suddenly disconnected and “PC CONNECT” disappears from the LCD.	→ The supplied AC power adaptor was not connected and the battery is exhausted. You need to connect the supplied AC power adaptor to the player.
The computer does not identify the player when it is connected to the computer.	→ Make sure the USB cable is correctly connected. (page 13)
There are only a few songs I can Check-Out. (The recordable time is short.)	→ If there is data other than audio files in the “Memory Stick,” copy them to your computer to free memory on the “Memory Stick.”
After connecting to the computer, the drive appears but there is nothing inside.	→ Make sure the “Memory Stick” is inserted and reconnect the player to your computer.
The computer/player do not operate normally when connected.	→ If you are connecting both devices with a USB hub or a USB extension cable, normal operation is not guaranteed. Please use only the supplied USB cable.
“Failed to authenticate the portable player” appears on the display when the player is connected to the computer.	→ You cannot use this player anymore. Please contact your nearest Sony dealer.

Other

Symptom	Cause/Remedy
The buttons do not operate.	→ Make sure the HOLD switch is OFF. (page 21) → You must recharge the battery. (page 10)
There is no beep sound to indicate that operation has been accepted.	→ Set the BEEP setting to ON in the menu. (page 21)
The EJECT lever does not work.	→ You must release the DC/USB adaptor. (page 10)
Cannot connect the DC/USB adaptor.	→ Make sure the DC/USB adaptor is correctly connected with the SONY logo on the upper side. (page 10) → Remove and reinsert the "Memory Stick."
Cannot release the DC/USB adaptor.	→ Press the Release button gently and then pull the DC/USB adaptor. (page 10)
Cannot insert the "Memory Stick."	→ Make sure the "Memory Stick" is correctly inserted as shown on Memory Stick Walkman. (page 13)
The current time is reset.	→ If you have reset the player by pressing the RESET button, the current time is reset. (page 35) → The battery is low and needs to be charged.
The player gets warm.	→ The player gets warm during charging and playback.
Cannot use a "Memory Stick" used on other devices.	→ Only "MagicGate Memory Stick" can be used with this player. → If the "Memory Stick" has been formatted using a computer, backup the files of the "Memory Stick" on your computer if necessary, and reformat the "Memory Stick" using this player. (page 23)

Troubleshooting (continued)

Error messages

Follow the instructions below if an error message appears in the display.

Message	Meaning	Remedy
ACCESS	Accessing the "Memory Stick."	This is not an error. Please wait for access to be finished. Do not take out the "Memory Stick" or unplug the AC power adaptor.
CANNOT PLAY	<ul style="list-style-type: none">• The player cannot playback certain contents of this "Memory Stick" due to a difference in format.• The data's playback date has expired.• The current date has not been set to playback data with date limits.• Check-Out has been interrupted forcefully.	<ul style="list-style-type: none">• You need to set the current date to playback data with date limits.• If there is data in a different format, you must delete that data from the "Memory Stick." See "To delete abnormal data from the Memory Stick," on page 39.
FILE ERROR	<ul style="list-style-type: none">• Cannot read the data.• The data is not normal.	You need to Check-In data you are able to Check-In into your computer, then format the "Memory Stick" using this player. (See "To delete abnormal data from the Memory Stick" on page 39.)
FORMAT ERROR	The inserted "Memory Stick" contains a data format which is not supported by Memory Stick Walkman. (For example, if you format the "Memory Stick" using the computer.)	You must format the "Memory Stick" following the instructions on page 23. (You must format the "Memory Stick" using this player. If you format the "Memory Stick" using the computer, you may Check-In/Out, but you cannot playback using this player.)
HI DC IN	The DC IN voltage is too high. (You are not using the supplied AC power adaptor.)	You must use the supplied AC power adaptor.
HOLD	The HOLD switch is ON, and no operating buttons are available (except the EJECT lever).	This is not an error. Switch the HOLD switch to OFF before operating the buttons.
LEGAL LOCK	The erasure prevention switch on the "Memory Stick" is on LOCK while trying to playback data with date limits.	Slide the erasure prevention switch on the "Memory Stick" to OFF.
LOCKED	The erasure prevention switch of the "Memory Stick" is on LOCK.	Switch the erasure prevention switch to OFF when connecting to your computer or formatting a "Memory Stick."
LOW BATT	The battery is low, and needs to be charged.	You must charge the battery.
LOW DC IN	The DC IN voltage is too low. (You are not using the supplied AC power adaptor. The AC power adaptor or DC/USB adaptor are not connected correctly.)	You must use the supplied AC power adaptor. Make sure it is correctly connected.
NO AUDIO	<ul style="list-style-type: none">• There is no music data in "MagicGate Memory Stick."• The "Memory Stick" is not "MagicGate Memory Stick."	Check that "MagicGate Memory Stick" is inserted. If there is no music data in "MagicGate Memory Stick," use the OpenMG Jukebox to Check-Out music items.

Message	Meaning	Remedy
NO DATA	There are no tracks inside "MagicGate Memory Stick."	Use the OpenMG Jukebox to Check-Out music items.
NO STICK	There is no "Memory Stick" inserted.	Insert a "Memory Stick."
PC CONNECT	The player is connected to the computer.	This is not an error. You can operate using the OpenMG Jukebox software, but you cannot operate the controls on the player.
STICK ERROR	You cannot access the "Memory Stick," or the data inside the "Memory Stick" or the player itself is not normal.	Eject and reinsert the "Memory Stick" a few times. If this does not solve the problem, Check-In data items into the computer, and then format the "Memory Stick" using this player. (See below "To delete abnormal data from the Memory Stick.") If the problem persists, bring both the player and the "Memory Stick" to your nearest Sony dealer.

To delete abnormal data from the "Memory Stick"

If "CANNOT PLAY," "FILE ERROR," "STICK ERROR" appears in the display window, there is abnormal data in the "Memory Stick."

Please follow the instructions below to delete abnormal data (data you cannot playback).

- 1** Connect Memory Stick Walkman to your computer and open the Portable Player window. (page 13)
- 2** If the cause of the abnormal data is clear (data of which the playback date limits have expired, etc.), delete the data from the Portable Player window.
- 3** If the problem persists, click the  button on the OpenMG Jukebox to Check-In all data you are able to Check-In.
- 4** Disconnect the player from the computer and then format the "Memory Stick" using the menu. (page 23)

Note

If you format the "Memory Stick," data that has been recorded using other devices will be deleted, too. If there are other data in the "Memory Stick," check the data contents using a compatible equipment before formatting the "Memory Stick."

Specifications

Recording time (when using the supplied 64MB "MagicGate Memory Stick")

Approx. 60 min. (132kbps)
Approx. 80 min. (105kbps)
Approx. 120 min. (66kbps)

Sampling frequency response

44.1kHz

Recording format

ATRAC3

Frequency response

20 to 20 000 Hz (single signal measurement)

Output

Headphone: stereo mini-jack

Signal-to-noise ratio (S/N)

More than 80dB (excluding 66 kbps)
Model for France only: more than 78dB

Dynamic range

More than 85dB (excluding 66 kbps)

Operating temperature

5°C to 35°C (-41°F to 95°F)

Power source

- DC IN 3.7V (internal Lithium-ion battery)
- DC IN 5.5V (supplied AC power adaptor)

Battery life

Approx. 4 hours

Dimensions (approx.)

37 × 96.3 × 19.2 mm (1 1/2 × 3 7/8 × 25/32 inches)
(w/h/d, projecting parts not included)

Mass (approx.)

70g (2.5 oz) (internal battery and a "Memory Stick" included)

Supplied accessories

64MB "MagicGate Memory Stick"
AC power adaptor
DC/USB adaptor
Headphones
Headphones extension cord
USB cable
CD-ROM
Strap (For U.S.A. and Canadian model only)
Carrying pouch (except for U.S.A. and Canadian model)
Operating Instructions

Optional accessories

"MagicGate Memory Stick" MSG-32A (32MB)
MSG-64A (64MB)

Design and specifications are subject to change without notice.

Note on the supplied "Magic Gate Memory Stick"

For the customers in the United States

This device complies with Part 15 of the FCC Rules. Operation is subject to the following two conditions: (1) This device may not cause harmful interference, and (2) this device must accept any interference received, including interference that may cause undesired operation.

For the customers in Canada

This class B digital apparatus complies with Canadian ICES-003.

Glossary

MagicGate

Copyright protection technology that consists of authentication and encryption technology. Authentication ensures that protected content is transferred only between compliant devices and media, and that protected content is recorded and transferred in an encrypted format to prevent unauthorized copying or playback.

Note

MAGICGATE is terminology denoting the copyright protection system developed by Sony. It does not guarantee conversion among other media.

“MagicGate Memory Stick”

A compact Integrated Circuit recording medium “Memory Stick” equipped with “MagicGate” copyright protection technology.

“Memory Stick”

“Memory Stick” is a portable and compact Integrated Circuit recording medium. There are two types of “Memory Stick”: “MagicGate Memory Stick” equipped with “MagicGate” copyright protection technology and a normal “Memory Stick” not equipped with the copyright protection technology. You can record image files, audio files, and sound files using “Memory Stick” compatible audio visual devices, or record data from the computer. Data with different formats can be stored in the same “Memory Stick.” (Please refer to the instruction manuals that come with the devices to check which format the equipment is able to read.)

For example, you can store image files in the space available on “MagicGate Memory Stick” using the respective equipment even if there are already audio files in “MagicGate Memory Stick.”

OpenMG

Copyright protection technology that securely manages music content from the EMD/Audio CD on a personal computer. Application software that is installed on the computer encrypts the digital music content when recording on the hard drive. This allows you to enjoy music content on the computer, but prevents unauthorized transmission of this content across a network (or elsewhere). This PC copyright protection complies with “MagicGate,” and allows you to transfer digital music content from a PC’s hard drive to a compliant device.

ATRAC3

ATRAC3, which stands for Adaptive Transform Acoustic Coding³, is audio compression technology that satisfies the demand for high sound quality and high compression rates.

The ATRAC3 compression rate is double that of the Mini Disc, resulting in increased data capacity for the media.

SDMI

SDMI which stands for Secure Digital Music Initiative, is a forum that consists of over 130 companies in the fields of recorded audio content, computers, and consumer electronics, dedicated to developing an integrated method of copyright protection technology that can be used worldwide.

SDMI is working to create a framework for preventing improper usage of audio files and to promote legal music distribution services. The copyright protection technologies “OpenMG” and “MagicGate” are based upon the SDMI standard.

Glossary (continued)

“Check-In /Check-Out”

Check-Out is to transfer music files managed on a personal computer by an OpenMG-compliant software to a portable player (such as Memory Stick Walkman). Returning the Checked-Out music files back to that computer is to Check-In. (You cannot move a Checked-Out audio data to another computer.)

You can also Check-Out a music file, Check it back In, and then Check it Out again.

The SDMI rules provide that up to four copies of a music file can be created unless a special condition for usage is set. Thus, unless a special restriction exists while one copy is saved in the computer, the other three can be Checked-Out to the Portable Players.

MP3

Abbreviation for MPEG-1 Audio Layer3. A standard for audio data compression determined by the Motion Picture Experts Group, which is an ISO (International Organization for Standardization) working group.

It enables compression of audio data to about 1/10 of the data size of a standard compact disc. Since the MP3 encoding algorithm is disclosed, there are various encoders/decoders compliant with this standard, including freeware that is available for no charge. Thus, the MP3 standard is widely used in the computer field.

Bit rate

Quantity, per second, of information. The unit is bps (bit per second). You can choose from 132kbps/105kbps/66kbps when recording a compact disc or converting an MP3/WAV file to an ATRAC3 file. For example, 105kbps means there are 105000 bits of information per second being transferred. Bigger the number, larger is the information. When comparing audio files of the same format, you can enjoy a better sound quality when recorded at 132kbps than at 105kbps, also better at 103kbps than at 66kbps. (Audio files cannot be compared if of different format)

Restrictions on copyright protection by OpenMG

This product (NW-MS7) features OpenMG, a copyright protection technology developed by Sony to protect music copyrights.

OpenMG uses a high-level cryptographic technology to protect music contents with computers. Users should be notified of the restrictions mentioned below.

1. This product can only be used with a computer on which the supplied OpenMG Jukebox software has been installed.
2. Music recorded on the hard disk using the OpenMG Jukebox software cannot be played if copied onto other computers.
3. Music contents Checked-Out from a computer cannot be played if copied onto other computers.
4. Music contents Checked-Out from a computer must be Checked-In to the same computer. You cannot Check-In to other computers.
5. Installation of the same OpenMG Jukebox software onto other computers is not permitted.
6. Usage Rules for using music
If a Usage Rule is included in the music by way of the copyright holder or the distributor, operation will be restricted to use permitted by the Usage Rule. For music, such as compact discs, that does not contain a Usage Rule, the Default Usage Rule of SDMI will be followed. This Default Usage Rule states that one file can be Checked-Out up to three times only.
7. On music contents that are not compatible with the OpenMG Jukebox software
Under the supervision of SDMI, this software prohibits recording of music with a copy prohibition signal.
8. Upgrading the supplied OpenMG Jukebox
This software was developed in accordance with the current arrangement between Sony and SDMI. If this arrangement is modified in the future, some of the software functions may become unavailable. Sony may offer an upgrade kit in this case at additional user expense.

Looking at the controls

Memory Stick Walkman

(front)

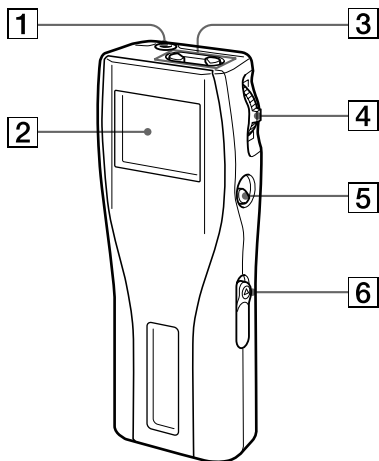

- 1 (Headphones) jack (page 16)
- 2 Display (page 17, 20)
- 3 VOLUME +/- button (page 16)
- 4 Jog lever (page 16 - 25)
- 5 (stop) button (page 16)
- 6 HOLD switch (page 21)

(rear)

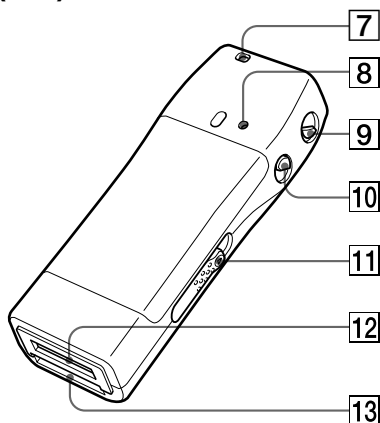

- 7 Strap hole for attaching the strap (supplied with U.S.A. model only)
- 8 RESET button (page 35)
- 9 MENU button (page 18 - 25)
- 10 DISPLAY button (page 20)
- 11 EJECT lever (page 17)
- 12 DC/USB adaptor plug (page 10)
- 13 Memory Stick slot (page 13, 16)

Display

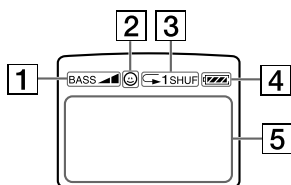

- 1 Mega-bass (page 18)
- 2 AVLS (page 20)
- 3 Playback mode (page 19)
- 4 Battery remain indication (page 10)
- 5 Information
Track name, track number, counter, menu items, error messages, etc., are displayed. (page 17, 20)

DC/USB adaptor

(front)

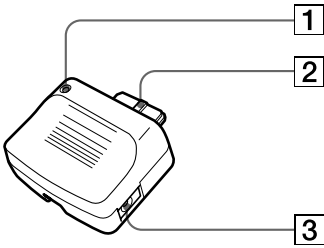

- 1 BATTERY CHARGE lamp (page 10)
- 2 Connector (page 10)
- 3 DC IN 5.5 V jack (page 10, 13)

(rear)

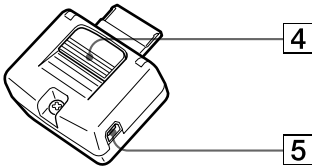

- 4 Release button (page 10)
- 5 USB jack (for the supplied USB cable)
(page 13)

Index

A

AC power adaptor 9, 10, 13, 31, 33, 36
album title 15, 17, 20, 26, 27
ATRAC3 41
AVLS 20

B

Backlight 22, 35
BASS 18
Battery 10, 34, 37
BATTERY CHARGE lamp
10, 45
BEEP 21
beginning of the track 17
Bit rate 15, 42

C

CD (compact disc) 14
CD drive 14
CD Recorder 14, 30
CD-ROM 11
charging 10, 34, 37
Check-In 5, 31, 42
Check-Out 5, 15, 39, 42
computer 4, 11, 13, 31, 36
CONTRAST 22
copyright protection technology
5, 41

D

DATE&TIME 24
DC/USB adaptor 9, 10, 13, 36, 45
display 17, 20
DISPLAY button 20
display mode 20
download 4, 12
driver (USB) 13

E

EMD services 12
erasure prevention switch
13, 23, 33, 35
Explorer 31

F

FORMAT 23, 31
formatting 23, 31, 38

G

go backward 17
go forward 17

H

hard drive 4, 13, 31
headphones 9, 16, 34
extension cord 9, 16
help file 8, 29, 30
HOLD 16, 21
Hold switch 16, 21

I

install 11
Internet (EMD services) 12

J

Jog lever 16, 18, 21, 25

L

LCD 22
backlight 22
contrast 22
LIGHT 22
listen to music 16

M

MagicGate	4, 6, 41
“MagicGate Memory Stick”	4, 9, 13, 16, 41
“Memory Stick”	6, 13, 16, 41
insert	13, 16
Menu	25, 28
MP3	42

O

online help	8
OpenMG	4, 41
OpenMG Jukebox software	4, 11, 14, 26, 28
OpenMG CD Recorder	14, 30
optimizing the CD drive	14

P

pause	17
playback	16
Portable Player window	14, 27
previous tracks	17

Q

quit (software)	26
-----------------	----

R

record	14
REPEAT	19
RESET button	35, 44
restrictions	43
RETURN	25

S

SDMI	4, 41
set the current time	24
song title	17, 20, 25, 26
start (software)	14
succeeding tracks	17
supplied accessories	9

T

TITLE	25
transferring	13, 31
to your computer	31
to the “Memory Stick”	13
troubleshooting	35

U

upgrading	43
uninstalling	32
Usage Rule	43
USB cable	9, 13, 36, 45
USB driver	13

V

volume	16
--------	----

W

WAV format	4
window	26
Windows Explorer	31

