

Bluetooth™ Wireless Audio Adapter (Transmitter / Receiver)

Operating Instructions



HWS-BTA2W

WARNING

To reduce the risk of fire or electric shock, do not expose this apparatus to rain or moisture.

To reduce the risk of electrical shock, do not open the cabinet. Refer servicing to qualified personnel only.

Do not install the appliance in a confined space, such as a bookcase or built-in cabinet.

To reduce the risk of fire, do not cover the ventilation of the apparatus with newspapers, tablecloths, curtains, etc. And do not place lighted candles on the apparatus.

To reduce the risk of fire or electric shock, do not place objects filled with liquids, such as vases, on the apparatus.

Connect the AC power adaptor to an easily accessible AC outlet. Should you notice an abnormality in the AC power adaptor, disconnect it from the AC outlet immediately.



Hereby, Sony Corp., declares that this equipment is in compliance with the essential requirements and other relevant provisions of Directive 1999/5/EC.

For details, please access the following URL:
<http://www.compliance.sony.de/>

The Bluetooth word mark and logos are owned by the Bluetooth SIG, Inc. and any use of such marks by Sony Corporation is under license. Other trademarks and trade names are those of their respective owners.

MPEG Layer-3 audio coding technology and patents licensed from Fraunhofer IIS and Thomson.



Disposal of Old Electrical & Electronic Equipment (Applicable in the European Union and other European countries with separate collection systems)

This symbol on the product or on its packaging indicates that this product shall not be treated as household waste. Instead it shall be handed over to the applicable collection point for the recycling of electrical and electronic equipment. By ensuring this product is disposed of correctly, you will help prevent potential negative consequences for the environment and human health, which could otherwise be caused by inappropriate waste handling of this product. The recycling of materials will help to conserve natural resources. For more detailed information about recycling of this product, please contact your local Civic Office, your household waste disposal service or the shop where you purchased the product.

Table Of Contents

Features	4
Using as a receiver	5
Using as a transmitter	6
Unpacking	7
Location and Function of	
Parts	8
Using the stand	9
On Pairing	10
On Indicators	10
Using as a Receiver	11
Preparation	11
Pairing	12
Receiving	14
Using as a Transmitter	15
Preparation	15
Pairing	16
Transmitting	17
Precautions	18
What is BLUETOOTH	
technology?	20
Troubleshooting	21
Initializing this unit	22
Specifications	23

Features

This unit is an audio adapter which can be used in two ways: as a stereo wireless receiver or transmitter, using BLUETOOTH wireless technology. You can enjoy stereo audio signal transmission (receive/transmit) of the BLUETOOTH wireless technology by using your stereo audio devices.

As a receiver

This unit can receive stereo audio signal from a BLUETOOTH stereo audio source device (mobile phone, digital music player, etc.) *.

By converting the wireless stereo audio signal (digital) to analogue audio signal, you can enjoy listening to music with your stereo audio output device (stereo component system, radio-cassette recorder, etc.) connected to this unit.

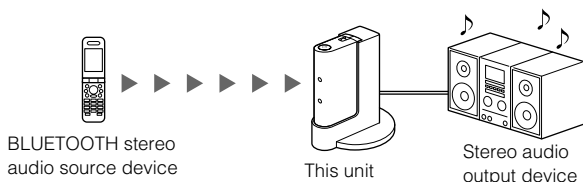

As a transmitter

This unit can transmit stereo audio signal to a BLUETOOTH stereo audio receiving device (car audio unit, headset, stereo component system, etc.) *.

By converting a regular stereo audio signal input (analogue) from the connected stereo audio source device to digital stereo audio signal and transmitting it wirelessly, you can enjoy listening to the music of your stereo audio source device connected to this unit (computer, portable audio player, mobile phone, etc.).

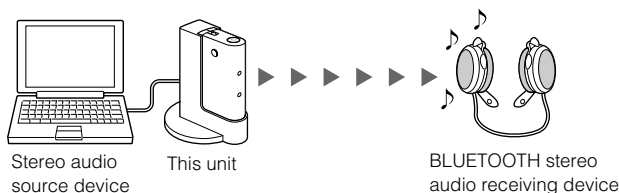

Tip

For example, you can receive the music on a car audio unit with BLUETOOTH function by connecting a portable audio player to this unit. In this case, use of the Car Battery Cord DCC-E345 (optional) is recommended.

* BLUETOOTH devices to be connected with this unit are required to support A2DP (Advanced Audio Distribution Profile).

Using as a receiver

In the example below, we explain how to receive music played on a BLUETOOTH mobile phone with the music playback function on this unit and listen to music on a stereo system connected to this unit.

Pairing

Enables a BLUETOOTH mobile phone and this unit to recognize one another.

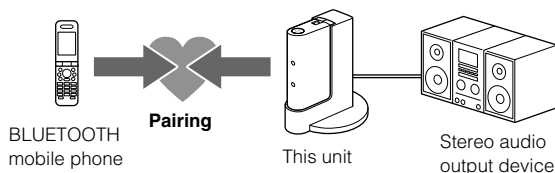

For more details, see pages 10 and 12.



BLUETOOTH connection

Operate the BLUETOOTH mobile phone to make the BLUETOOTH connection.

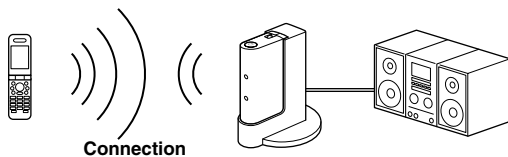

Receiving music

Enjoy listening to music played on the BLUETOOTH mobile phone through a stereo audio output device connected to this unit.

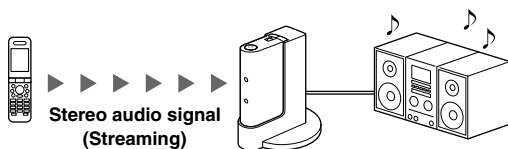

For more details, see page 14.

Using as a transmitter

In the example below, we explain how to transmit music played on your computer connected to this unit and listen to music on a BLUETOOTH stereo audio receiving device (headphone, stereo audio system, etc.).

Pairing

Enables a BLUETOOTH stereo audio receiving device and this unit to recognize one another.

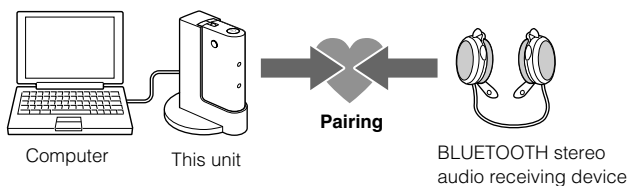

For more details, see pages 10 and 16.



BLUETOOTH connection

Turning on this unit automatically makes the BLUETOOTH connection between this unit and the BLUETOOTH stereo audio receiving device.

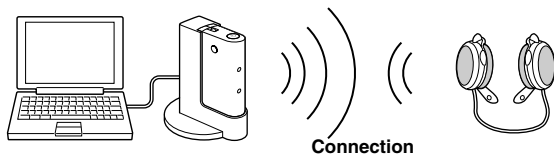

Transmitting music

You can enjoy listening to music played on your computer, etc., connected to this unit through the BLUETOOTH stereo audio receiving system.



For more details, see page 17.

Unpacking

Check that you have the following items:

- BLUETOOTH Wireless Audio Adapter (1)

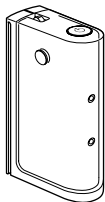

- Connecting cable (stereo mini plug ↔ stereo mini plug), 1.0 m (1)



- Operating Instructions (1)

- Stand (1)

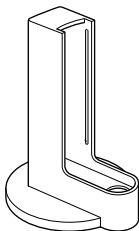

Tip

See page 9 on how to use the stand.

- AC power adaptor (1)

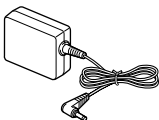

Location and Function of Parts

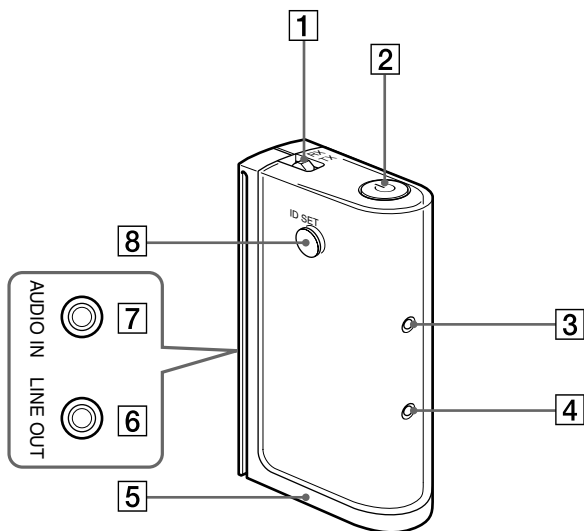

1 TX/RX (transmitter / receiver) switch

For switching between transmitter and receiver.

2  (power) button

Press to turn on the unit. Press a little longer to turn off the unit.

3  (power) indicator

4  (communication status) indicator

5 DC IN 4.5 V jack

6 LINE OUT (audio output) jack

Connects to the LINE IN jack of a stereo component system, radio-cassette recorder, etc.

7 AUDIO IN (audio input) jack

Connects to the headphone jack of a computer, portable audio player, etc.

Note

Do not connect to the LINE OUT jack of the connected device. It may cause distortion.

8 ID SET (pairing) button

For pairing with other BLUETOOTH device.

Using the stand

Attach the supplied stand to install this unit vertically, following the procedure below.

1 Align the rail of the stand with the groove of this unit.

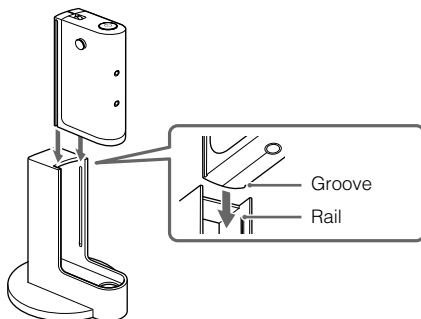

2 Slide this unit along the groove until this unit stops.

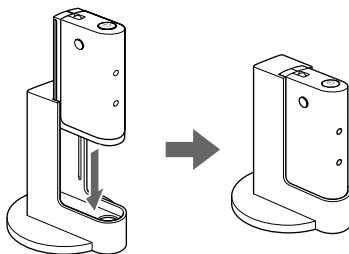

Notes

- When not using the stand, do not lay this unit on its side on a desk made of metal.
- Do not use the stand in a car, since the temperature may become high depending on the condition.

On Pairing

What is pairing?



BLUETOOTH devices need to be “paired” with each other beforehand.

Once BLUETOOTH devices are paired, there is no need for pairing again, except in the following cases:

- Pairing information is deleted after repair, etc.
- This unit is paired with 9 or more devices.
This unit can be paired with up to 8 BLUETOOTH stereo audio receiving device and transmitting device. If a new device is paired after 8 devices have been paired, the device whose latest connection time is the oldest among the 8 paired devices is replaced by the new one.
- This unit is reset.
All pairing information is deleted. (See page 22.)

See page 12 (as a receiver), or page 16 (as a transmitter) on how to pair devices.

On Indicators

Status	 indicator (green)	 indicator (blue)
Power on	Lights up	Off
Pairing mode	Flashes	Flashes
Connecting or communicating	Lights up	Lights up

Using as a Receiver

Used as a receiver, this unit receives music transmitted from a BLUETOOTH stereo audio source device.

Example

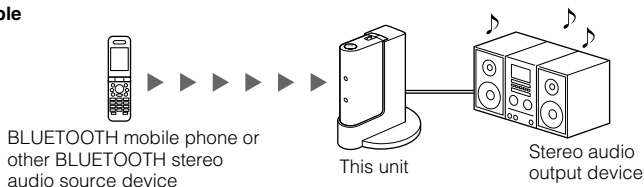

Note

For details on how to operate the devices to be connected, refer to the operating instructions supplied with each device.

Preparation

- 1 **Connect the LINE IN jack of a stereo audio output device to the LINE OUT jack of this unit with the supplied connecting cable.**

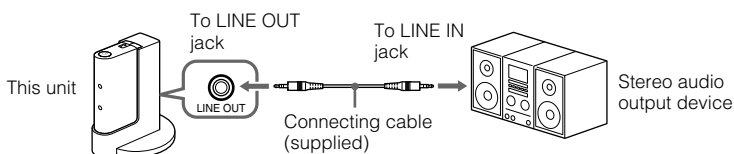

Tip

When connecting this unit to the phono jack of another device, use the connecting cable RK-G129 (optional).

- 2 **Connect the supplied AC power adaptor to the DC IN 4.5 V jack on this unit.**

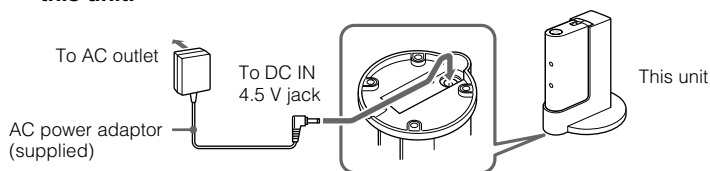

- 3 **Set the TX/RX switch to "RX."**

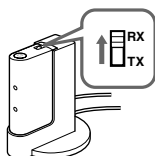



Pairing

Check the following before operating the unit.

- The TX/RX switch is set to "RX."
- This unit is connected to a power source and the  indicator (green) goes off.

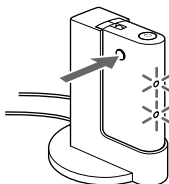
1 Press and hold the ID SET button for 7 seconds or more.



When the  indicator (green) and  indicator (blue) start flashing together, release the button. This unit enters pairing mode.

Note

Pairing mode is cancelled and this unit is turned off after about 5 minutes. If this unit is turned off while performing the procedure, start over from step 1.

2 Perform pairing procedure on the BLUETOOTH stereo audio source device to detect this unit.

The list of detected devices appear on the display of the BLUETOOTH stereo audio source device.

This unit is displayed as "HWS-BTA2W."

If "HWS-BTA2W" is not displayed, repeat from step 1.

Notes

- When pairing, be sure to place both the BLUETOOTH devices within 1 m (3 ft) of each other.
- Some devices cannot display the list of detected devices.



3 Select "HWS-BTA2W" appeared on the display of the BLUETOOTH stereo audio source device.

4 If Passcode* input is required on the display of the BLUETOOTH stereo audio source device, input “0000.”

* Passcode may be called “Passkey,” “PIN code,” “PIN number,” or “Password.”

5 Start the BLUETOOTH connection from the BLUETOOTH device.

Some BLUETOOTH stereo audio source devices may connect with the unit automatically when pairing is complete.

When the BLUETOOTH connection is made properly, both the  indicator (green) and  indicator (blue) light up indicating that pairing is complete, and pairing information is memorized on this unit.

Note

If you turn off this unit or the BLUETOOTH stereo audio source device, pairing information is not memorized and pairing is not complete.

When pairing with a BLUETOOTH stereo audio source device that cannot display a list of detected devices or that has no display

You may pair the device by setting both this unit and the BLUETOOTH stereo audio source device to pairing mode. For details, refer to the operating instructions supplied with the device.

If pairing is not complete

Start over from step **1**.

Tip

To pair with other BLUETOOTH devices, repeat steps **1** to **5** for each device.

Note

Passcode of this unit is fixed to “0000.” This unit cannot be paired with a BLUETOOTH stereo audio source device whose Passcode is not “0000.”

Receiving

Check the following before operating the unit.

- The TX/RX switch is set to "RX."
- The BLUETOOTH stereo audio source device's BLUETOOTH function is on.
- Pairing of this unit and the BLUETOOTH stereo audio source device is complete.

- 1 Press the  button to turn on this unit.**
- 2 Turn on the stereo audio output device connected to this unit, and select the auxiliary input.**
- 3 Start the BLUETOOTH connection from the BLUETOOTH stereo audio source device.**
- 4 Start playing on the BLUETOOTH stereo audio source device.**

Note

Turn off the bass boost function or equalizer function. If these functions are on, sound may be distorted.

Note

In the following cases, you need to make the BLUETOOTH connection again.

- The power of this unit does not turn on.
- The power of the BLUETOOTH stereo audio source device does not turn on, or the BLUETOOTH function is off.
- The BLUETOOTH function of this unit or the BLUETOOTH stereo audio source device is in sleep mode.
- The BLUETOOTH connection is not made.

To finish receiving

Terminate the BLUETOOTH connection by any of the operations below.

- Operate the BLUETOOTH stereo audio source device to terminate the connection. For details, refer to the operating instructions supplied with the device.
- Turn off the BLUETOOTH stereo audio source device.
- Turn off this unit.

Using as a Transmitter

This unit transmits music played on a stereo audio source device connected to this unit to a BLUETOOTH stereo audio receiving device.

Example

Computer or other stereo audio source device

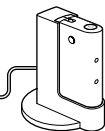

This unit



BLUETOOTH stereo audio receiving device

Note

For details on how to operate the devices to be connected, refer to the operating instructions supplied with each device.

Preparation

- 1 Connect the headphone jack of a stereo audio source device to the AUDIO IN jack of this unit with the supplied connecting cable.**

Computer or other stereo audio source device

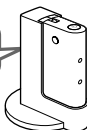
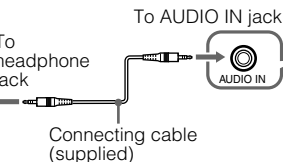

This unit

Note

Be sure to connect this unit to the headphone jack of the stereo audio source device to be connected. If this unit is connected to the LINE OUT jack of the device to be connected, sound may be distorted. If the stereo audio source device has switching between headphone and LINE OUT on the same jack, use the headphone setting.

- 2 Connect the supplied AC power adaptor to the DC IN 4.5 V jack on this unit.**

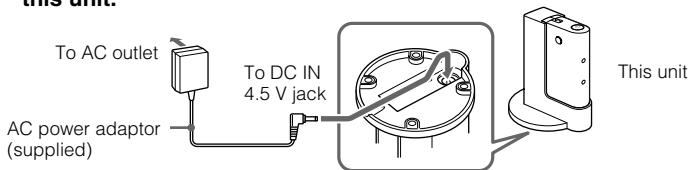

When using this unit in a car, use the Car Battery Cord DCC-E345 (optional).

- 3 Set the TX/RX switch to "TX."**

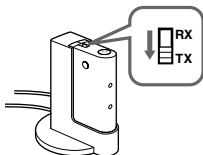

Pairing

Check the following before operating the unit.

- The TX/RX switch is set to “TX.”
- This unit is connected to a power source and the \odot indicator (green) goes off.

1 Press and hold the ID SET button for 7 seconds or more.

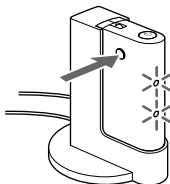

When the \odot indicator (green) and \otimes indicator (blue) start flashing together, release the button. This unit enters pairing mode.

Note

Pairing mode is cancelled and this unit is turned off after about 5 minutes. If this unit is turned off while performing the procedure, start over from step 1.

2 Set the BLUETOOTH stereo audio receiving device to pairing mode.

This unit searches the BLUETOOTH stereo audio receiving device automatically, and pairs the device.

This unit tries to connect the BLUETOOTH stereo audio receiving device soon after detecting it. When the BLUETOOTH connection is made properly, both the \odot indicator (green) and \otimes indicator (blue) light up, indicating pairing is complete, and pairing information is memorized on this unit.

Notes

- When pairing, be sure to place both the BLUETOOTH devices within 1 m (3 ft) of each other.
- Passcode of this unit is fixed to “0000.” When using this unit as a transmitter, this unit cannot be paired with a BLUETOOTH stereo audio receiving device whose Passcode is not “0000.”

* Passcode may be called “Passkey,” “PIN code,” “PIN number,” or “Password.”

If pairing is not complete

Start over from step 1.

Tip

To pair with other BLUETOOTH devices, repeat steps 1 to 2 for each device.

Note

BLUETOOTH connection may be made on some devices automatically when pairing is complete. In such a case, both the \odot indicator (green) and the \otimes indicator (blue) light up, indicating that the BLUETOOTH connection has been made.

Transmitting

Check the following before operating the unit.

- The TX/RX switch is set to "TX."
- The BLUETOOTH stereo audio receiving device's BLUETOOTH function is on.
- Pairing of this unit and the BLUETOOTH stereo audio receiving device is complete.

1 Press the  button to turn on this unit.

2 Prepare the BLUETOOTH stereo audio receiving device to be connected within 5 minutes after turning on this unit.

This unit turns off 5 minutes after turning on without making the BLUETOOTH connection. If this unit turns off before the BLUETOOTH connection is made, turn it on again.

Note

When using this unit as a transmitter, this unit tries to connect with either of the last two devices recognized before. If this unit cannot make the BLUETOOTH connection with a paired device, pair the device again, or try making the BLUETOOTH connection from the BLUETOOTH stereo audio receiving device if possible.

3 Start playing on the stereo audio source device connected to this unit.

4 Adjust the volume of the stereo audio source device connected to this unit.

Turn up the volume of the stereo audio source device as high as possible to the extent that sound is not distorted.

Note

Turn off the bass boost function or equalizer function. If these functions are on, sound may be distorted.

Note

In the following cases, you need to make the BLUETOOTH connection again.

- The power of this unit does not turn on.
- The power of the BLUETOOTH stereo audio receiving device does not turn on, or the BLUETOOTH function is off.
- The BLUETOOTH function of this unit or the BLUETOOTH stereo audio receiving device is in sleep mode.
- The BLUETOOTH connection is not made.

To finish transmitting

Terminate the BLUETOOTH connection by any of the operations below.

- Turn off this unit.
- Turn off the BLUETOOTH stereo audio receiving device.

Precautions

On BLUETOOTH communication

- BLUETOOTH wireless technology operates within a range of about 10 meters (about 30 feet). Maximum communication range may vary depending on obstacles (person, metal, wall, etc.) or electromagnetic environment.

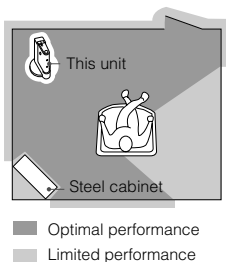

- The following conditions may affect the sensitivity of BLUETOOTH communication.
 - There is an obstacle such as a person, metal, or wall between this unit and BLUETOOTH device.
 - A device using 2.4 GHz frequency, such as a wireless LAN device, cordless telephone, or microwave oven, is in use near this unit.
 - This unit is installed horizontally on a desk made of steel.
- Because BLUETOOTH devices and wireless LAN (IEEE802.11b/g) use the same frequency, microwave interference may occur and resulting in communication speed deterioration, noise, or invalid connection if this unit is used near a wireless LAN device. In such a case, perform the following.
 - Use this unit at least 10 m (about 30 ft) away from the wireless LAN device.
 - If this unit is used within 10 m (about 30 ft) of a wireless LAN device, turn off the wireless LAN device.
 - Install this unit and BLUETOOTH device as near to each other as possible.
- Microwaves emitting from a BLUETOOTH device may affect the operation of electronic medical devices. Turn off this unit and other BLUETOOTH devices in the following locations, as it may cause an accident.
 - where inflammable gas is present, in a hospital, train, airplane, or a petrol station
 - near automatic doors or a fire alarm
- This unit supports security capabilities that comply with the BLUETOOTH standard to provide a secure connection when the BLUETOOTH wireless technology is used, but security may not be enough depending on the setting. Be careful when communicating using BLUETOOTH wireless technology.
- We do not take any responsibility for the leakage of information during BLUETOOTH communication.
- Connection with all BLUETOOTH devices cannot be guaranteed.
 - A device featuring BLUETOOTH function is required to conform to the BLUETOOTH standard specified by BLUETOOTH SIG, and be authenticated.
 - Even if the connected device conforms to the above mentioned BLUETOOTH standard, some devices may not be connected or work correctly, depending on the features or specifications of the device.
- Depending on the device to be connected, it may require some time to start communication.

On safety

- Do not drop, hit, or otherwise expose the unit to strong shock of any kind. This could damage the product.
- Do not disassemble or attempt to open any parts of the unit.

On placement

- Do not place the unit in any of the following locations.
 - Direct sunlight, near a heater, or other extremely high-temperature location
 - Dusty location
 - An unsteady or inclined surface
 - Location exposed to large amounts of vibration
 - Bathroom or other high-humidity location
 - In a car subject to the direct rays of the sun.

Notes when using with a mobile phone

- You cannot use this unit to talk over the telephone, even if the BLUETOOTH connection between this unit and a mobile phone is made.
- For details on operation of your mobile phone when receiving a telephone call while transmitting music using the BLUETOOTH connection, refer to the operating instructions supplied with the mobile phone.

Notes on using in a car

- Do not attempt to connect this unit, or to operate this unit, an audio output device or a car radio while driving or waiting at a traffic signal.
- Unplug the DC adaptor which supplies power to this unit from the cigarette lighter socket whenever the engine of the car is not running. Depending on the car type, even if the ignition key is off, the power supply may not turn off automatically. In this case, this may cause unnecessary car battery consumption.
- When not in use, unplug the DC adaptor from the cigarette lighter socket and store this unit and the device connected to this unit in a safe place where it will not interfere with your driving or become entangled in parts of the car interior (seat, door, etc.)
- Make sure this unit and the device connected to this unit are fixed firmly before driving to avoid an accident or damage.
- Route all the cable connected to this unit properly so that they will not interfere with your driving or become entangled in parts of the car interior (seat, door, etc.).
- Never yank or pull the cable. This may cause a malfunction or a wire break.
- Do not use the stand in a car since the temperature may become high.

On the supplied AC power adaptor

- Use the AC power adaptor supplied with this unit. Do not use any other AC power adaptor since it may cause the unit to malfunction.



Polarity of the plug

- If you are not going to use this unit for a long time, unplug the AC power adaptor from the AC outlet. To remove the AC power adaptor from the wall outlet, grasp the adaptor plug itself; never pull the cord.

Others

- If you have any questions or problems concerning this unit that are not covered in this manual, please consult your nearest Sony dealer.
- Should any problem persist, consult your nearest Sony dealer.

What is BLUETOOTH technology?

BLUETOOTH wireless technology is a short-range wireless technology that enables wireless data communication between digital devices, such as a computer or digital camera. BLUETOOTH wireless technology operates within a range of about 10 meters (about 30 feet). Connecting two devices as necessary is common, but some devices can be connected to multiple devices at the same time.*

You do not need to use a cable for connection since BLUETOOTH technology is a wireless technology, nor is it necessary for the devices to face one another, such is the case with infrared technology. For example, you can use such a device in a bag or pocket. BLUETOOTH technology is an international standard supported by thousands of companies all over the world, and employed by various companies worldwide.

* This unit cannot be connected to multiple devices at the same time.

Communication System and Compatible BLUETOOTH Profile of this unit

Profile is standardization of the function for each BLUETOOTH device specification. This unit supports the following BLUETOOTH version and profile:

Communication System: BLUETOOTH Specification version 2.0

Compatible BLUETOOTH Profile:

- A2DP (Advanced Audio Distribution Profile)

Troubleshooting

If you run into any problems using this unit, use the following checklist. Should any problem persist, consult your nearest Sony dealer.

When using as a receiver

No sound

- ➔ Check the connection between this unit and the stereo audio output device connected to this unit.
- ➔ Check that both this unit and the BLUETOOTH stereo audio source device are turned on.
- ➔ Ensure that this unit is not too far from the BLUETOOTH stereo audio source device, or this unit is not receiving interference from a wireless LAN, other 2.4 GHz wireless device, or microwave oven.
- ➔ Check that the BLUETOOTH connection is made properly between this unit and the BLUETOOTH stereo audio source device.
- ➔ Turn up the volume of the stereo audio output device.
- ➔ Turn up the volume of the BLUETOOTH stereo audio source device as high as possible to the extent that sound is not distorted. For details on volume adjustment, refer to the operating instructions supplied with the BLUETOOTH stereo audio source device.
- ➔ Pair this unit and the BLUETOOTH stereo audio source device again.

Low sound level

- ➔ Turn up the volume of the BLUETOOTH stereo audio source device as high as possible to the extent that sound is not distorted. For details on volume adjustment, refer to the operating instructions supplied with the BLUETOOTH stereo audio source device.
- ➔ Turn up the volume of the stereo audio output device.

Distorted sound

- ➔ Turn down the volume of the BLUETOOTH stereo audio source device to the point where the sound is no longer distorted. For details on volume adjustment, refer to the operating instructions supplied with the BLUETOOTH stereo audio source device.

When using as a transmitter

No sound

- ➔ Check the connection between this unit and the stereo audio source device connected to this unit.
- ➔ Check that both this unit and the BLUETOOTH stereo audio receiving device are turned on.
- ➔ Ensure that this unit is not too far from the BLUETOOTH stereo audio receiving device, or this unit is not receiving interference from a wireless LAN, other 2.4 GHz wireless device, or microwave oven.
- ➔ Check that BLUETOOTH connection is made properly between this unit and the BLUETOOTH stereo audio receiving device.
- ➔ Turn up the volume of the BLUETOOTH stereo audio receiving device. For details on volume adjustment, refer to the operating instructions supplied with the BLUETOOTH stereo audio receiving device.
- ➔ Turn up the volume of the stereo audio source device as high as possible to the extent that sound is not distorted.
- ➔ Pair this unit and the BLUETOOTH stereo audio receiving device again.

Low sound level

- ➔ Turn up the volume of the stereo audio source device as high as possible to the extent that sound is not distorted.
- ➔ Turn up the volume of the BLUETOOTH stereo audio receiving device. For details on volume adjustment, refer to the operating instructions supplied with the BLUETOOTH stereo audio receiving device.

Distorted sound

- ➔ Turn down the volume of the stereo audio source device to the point where the sound is no longer distorted. For details on volume adjustment, refer to the operating instructions supplied with the stereo audio source device.
- ➔ If the AUDIO IN jack of this unit is connected to the LINE OUT jack of the stereo audio source device, connect it to the headphone jack.
Be sure to connect this unit to the headphone jack of the stereo audio source device to be connected. If this unit is connected to the LINE OUT jack of the device to be connected, sound may be distorted.

Cannot be connected to a device that has been paired and connected before.

- ➔ When using this unit as a transmitter, this unit tries to connect with either of the last two devices recognized before. If this unit cannot make the BLUETOOTH connection with a paired device, pair the device again, or try making the BLUETOOTH connection from the BLUETOOTH stereo audio receiving device if possible.
- ➔ Pairing information may be deleted. Pair the device again.

Common

Sound skips or the correspondence distance is short.

- ➔ If a device that generates electromagnetic radiation, such as a wireless LAN, other BLUETOOTH device(s), or a microwave oven is nearby, move away from such sources.
- ➔ Remove any obstacle between this unit and other BLUETOOTH device or move away from the obstacle.
- ➔ Locate this unit and other BLUETOOTH device(s) as near as possible.
- ➔ Re-position this unit.
- ➔ Re-position other BLUETOOTH device.

Pairing cannot be done.



- ➔ Bring this unit and the BLUETOOTH device closer together.



Sound is delayed.

- ➔ If you watch a TV or a DVD through BLUETOOTH connection via this unit, sound may lag behind the picture.

Initializing this unit

You can reset this unit to its default and delete all pairing information.

- 1 If this unit is turned on, press the  button to turn off this unit.**
- 2 While holding the  button, press the ID SET button for 7 seconds or more.**

The  indicator (green) and the  indicator (blue) flash four times, and this unit is reset to the default setting. All pairing information is deleted.

Specifications

General

Communication System

BLUETOOTH Specification version 2.0

Output

BLUETOOTH Specification Power Class 2

Maximum communication range

Line of sight approx. 10 m (30 ft)*¹

Frequency band

2.4 GHz band (2.4000 GHz – 2.4835 GHz)

Modulation method

FHSS

Compatible BLUETOOTH Profile*²

A2DP (Advanced Audio Distribution Profile)

Supported Codecs*³

Receive: SBC*⁴, MP3

Transmit: SBC

Audio input

Stereo mini jack × 1

Audio output

Stereo mini jack × 1

Power requirements

DC 4.5 V (from the supplied AC power adaptor)

Rated power consumption

1 W

Dimensions

Approx. 17 × 67 × 34 mm

(¹¹/₁₆ × 2 ³/₄ × 1 ³/₈ in) (w/h/d)

Mass

Approx. 26 g (0.92 oz) (not including the stand or other supplied accessories)

Supplied accessories

AC power adaptor (1),

Stand (1),

Connecting cable (stereo mini plug ↔ stereo mini plug), 1.0 m (1)

Optional accessories

Car Battery Cord: DCC-E345

Connecting cable: RK-G129 (Stereo mini plug ↔ Phono plug × 2, 1.5 m)

Design and specifications are subject to change without notice.

*¹ The actual range will vary depending on factors such as obstacles between devices, magnetic fields around a microwave oven, static electricity, reception sensitivity, aerial's performance, operating system, software application, etc.

*² BLUETOOTH standard profiles indicate the purpose of BLUETOOTH communication between devices.

*³ Codec: Audio signal compression and conversion format

*⁴ Subband Codec

<http://www.sony.net/>

Printed in Malaysia



* 2 6 8 9 4 5 6 1 3 * (1)